

Proximity sensors SMT/SME-10, for C-slot

FESTO



Festo core product range
Covers 80% of your automation tasks



Ready for dispatch from the Festo factory in 24 hours
Held in stock in 13 service centres worldwide
More than 2200 products

Worldwide:

Always in stock

Superb:

Festo quality at an attractive price

Easy:

Reduces procurement and storing complexity



Ready for dispatch in 5 days maximum from stock
Assembled for you in 4 service centres worldwide
Up to 6 x 10¹² variants per product series

Look for the star!

Proximity sensors SMT/SME

Product range overview

FESTO

Design	Type of mounting	Measuring principle	Type	Operating voltage range	Switching output	Switching element function	→ Page/ Internet
For C-slot	Standard						
	Insertable in slot from above, flush with cylinder profile	Magneto-resistive	SMT-10M	5 ... 30 V DC	PNP	N/O contact	6
					NPN		
					Non-contacting, 2-wire		
		Magnetic reed	SME-10M	5 ... 30 V AC/DC	Contacting, bipolar	N/O contact	12
Insertable in slot length-wise	Magneto-resistive	SMT-10G	10 ... 30 V DC	PNP, NPN	N/O contact	23	
	Magnetic reed	SME-10	12 ... 27 V AC/DC	Contacting	N/O contact	19	
For T-slot	Standard						
	Insertable in slot from above, flush with cylinder profile	Magneto-resistive	SMT-8M	10 ... 30 V DC	PNP	N/O contact	t-slot
					NPN	N/C contact	
						N/O contact	
		Magnetic reed	SME-8M	5 ... 30 V AC/DC	Contacting, bipolar	N/O contact	
	Insertable in slot length-wise, flush with cylinder profile	Magneto-resistive	SMT-8	10 ... 30 V DC	PNP	N/O contact	
					NPN		
	Insertable in slot length-wise, flush with cylinder profile	Magnetic reed	SME-8	12 ... 30 V AC/DC	Contacting, bipolar	N/O contact	
				3 ... 230 V AC/DC		N/C contact	
				5 ... 250 V AC/DC		N/O contact	
	Insertable in slot length-wise	Magneto-resistive	SMT-8G	10 ... 30 V DC	PNP	N/O contact	
		Magneto-resistive	SMT-8-SL	10 ... 30 V DC	PNP	N/O contact	
		Magnetic reed	SME-8-SL	10 ... 30 V AC/DC	Contacting, bipolar	N/O contact	
	Insertable in slot from above	Magnetic reed	SME-8-FM	10 ... 30 V AC/DC	Contacting, bipolar	N/O contact	
	Via accessories	Magneto-resistive	SMT0-8E	10 ... 30 V DC	PNP	N/O contact	
					NPN		
		Magnetic reed	SME0-8E	12 ... 30 V DC	Contacting, bipolar	N/O contact	
				3 ... 250 V DC			
	3 ... 230 V AC						
	Corrosion resistant						
	Insertable in slot length-wise, flush with cylinder profile	Magneto-resistive	CRSMT-8	10 ... 30 V DC	PNP	N/O contact	t-slot
	Welding field immune						
	Via accessories	Magneto-inductive	SMTSO-8E	10 ... 30 V DC	PNP	N/O contact	t-slot
NPN							
Heat resistant up to 120 °C							
Insertable in slot length-wise, flush with cylinder profile	Magnetic reed	SME-8-...-S6	0 ... 30 V AC/DC	Contacting, bipolar	N/O contact	t-slot	
Via accessories	Magnetic reed	SME0-8E-...-S6	0 ... 30 V DC	Contacting	N/O contact	t-slot	
			0 ... 30 V AC				

Proximity sensors SMT/SME

Product range overview

FESTO

For gears used with T-slot are T-Nut switcher adaptable

Exceptions to

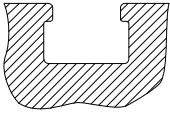

- DFM-B: SMT0-8E, SMTSO-8E, SME0-8E, SMPO-8E not adaptable
- DHDS: SME-8M only for \varnothing 50 adaptable
- DHPS: SME-8M only for \varnothing 20 ... 35 adaptable
- HGDD-63-A: SMT-8M-A not adaptable
- HGPT-B: SMT-8G can only be used from size 40 upwards
- SDBT-BSW- ... -PU/NU can only be used on a limited number of drive series

For gears used with C-slot are C-slot switcher adaptable

Exceptions to

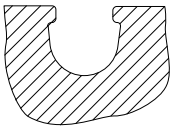

- ADVC \varnothing 100: SMT-10M and SME-10M not adaptable (ADVC within T-slot and C-slot equipped)
- DSM/DSM-B-6/8/10: SME-10M not adaptable
- DSM/DSM-B-10/16: SMT-10M not adaptable
- HGPT-B: SMT-10G can only be used up to size 35

For drives with sensor rail: these are available with 2 cylinder barrel contours

Only T-slot sensors CRSMT-8M and SMT-8M-A can be used, and only with the profile identified below as being suitable

Example: DSBF

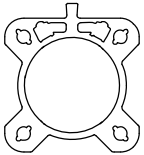

Suitable

Example: CDC

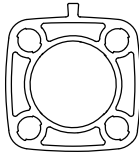

Not suitable

Proximity sensors SMT/SME-10, for C-slot

Overview of peripherals

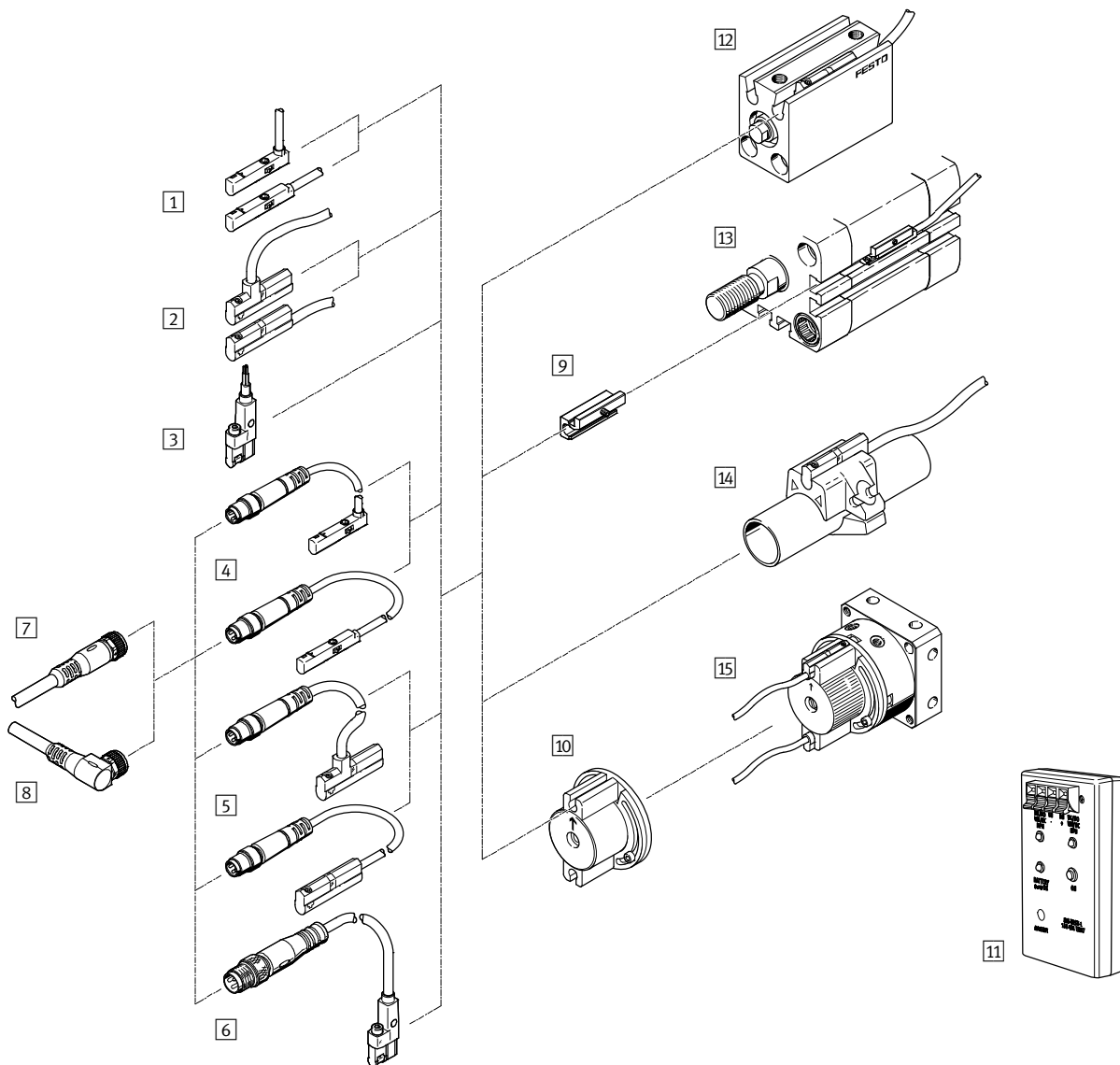

Mounting attachments and accessories	→ Page/ Internet
Proximity sensors	
1 SMT/SME-10M-...-OE, with cable	6
2 SME-10, with cable	19
3 SMT-10G-...-OE, with cable	24
4 SMT/SME-10M-...-M..., with cable and plug	6
5 SME-10, with cable and plug	19
6 SMT-10G-...-M..., with cable and plug	24
Connecting cables	
7 Connecting cable NEBU-M...G...	28
8 Connecting cable NEBU-M...W...	28
Mounting kits	
9 Mounting kit SMBN-10	27
10 Mounting kit WSM-...-SME-10	28

Mounting attachments and accessories	→ Page/ Internet
Accessories	
11 Sensor tester SM-TEST-1	29
- Positioning component SMM-10	28
- Clip SMBK-10	28
- Inscription label ASLR	29
- Safety clip NEAU	29
Drives	
12 Drives with C-slot	-
13 Drives with T-slot	-
14 Round cylinder	-
15 Semi-rotary drive DSM	-

Proximity sensors SMT/SME-10M, for C-slot

Type codes

SMT/SME-10M

SMT – 10M – PS – 24V – E – 2,5 – L – – OE

Function

SMT	Proximity sensor, magneto-resistive
SME	Proximity sensor, magnetic reed

Design

10M	For C-slot, insertable in slot from above
-----	---

Switching output, switching element function

PS	PNP, N/O contact, 3-wire
NS	NPN, N/O contact, 3-wire
ZS	N/O contact, 2-wire
DS	N/O contact, 3-wire

Rated operating voltage

24V	24 V DC
-----	---------

Cable attribute

E	Energy chain + robot applications
---	-----------------------------------

Cable length [m]

Cable outlet

L	In-line
Q	Lateral

Cable designation

–	With inscription label holder
N	Without inscription label holder

Connection technology

OE	Open end
M8	Cable with plug M8x1, snap-on flange
M8D	Cable with plug M8x1, rotatable thread
M12	Cable with plug M12x1, rotatable thread

Proximity sensors SMT-10M, for C-slot

Technical data – Magneto-resistive

Function

E.g. PNP, N/O contact, with cable

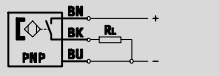

E.g. NPN, N/O contact, with cable

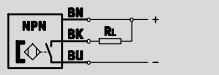

- Magneto-resistive measuring principle
- Insertable in slot from above, does not protrude over the cylinder profile
- Cable clip and inscription label holder included in the scope of delivery

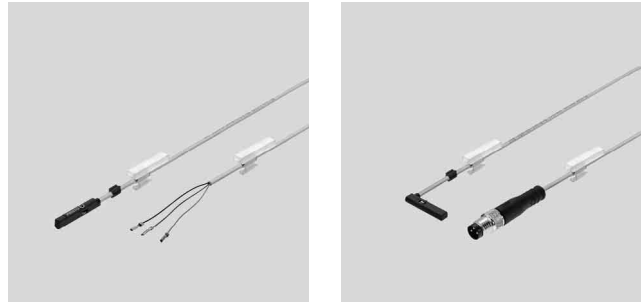

General technical data	
Design	For C-slot
Conforms to	EN 60947-5-2
Certification	RCM trademark
CE mark (see declaration of conformity)	To EU EMC Directive ¹⁾
Special features	Oil-resistant
Note on materials	Cable free of halogen
	Free of copper and PTFE
	RoHS-compliant

1) For information about the applicability of the component see the manufacturer's EC declaration of conformity at: www.festo.com/sp → User documentation.
If the component is subject to restrictions on usage in residential, office or commercial environments or small businesses, further measures to reduce the emitted interference may be necessary.

Input signal/measuring element			
Type SMT-10M	PS	NS	ZS
Measured variable	Position		
Measuring principle	Magneto-resistive		
Ambient temperature [°C]	-40 ... +70		
Fused switching field strength			
at -40 ... +70 °C [mT]	1.6 ... 3.0		1.95 ... 2.6
at 25 °C [mT]	1.8 ... 2.8		2.0 ... 2.5

Switching output			
Type SMT-10M	PS	NS	ZS
Switching output	PNP	NPN	Non-contacting, 2-wire
Switching element function	N/O contact		
Repetition accuracy of switching output in ± mm [mm]	0.1		
Switch-on time [ms]	≤1.3	≤1.3	≤1.0
Switch-off time [ms]	≤1.4	≤1.4	≤1.0
Max. switching frequency [Hz]	150		
Max. output current [mA]	100		
Max. output current in mounting kits [mA]	50		
Max. switching capacity DC [W]	2.8	2.8	2.4
Max. switching capacity DC in mounting kits [W]	1.5		1.2
Voltage drop [V]	≤1.7	≤1.5	≤6
Devices can be switched in parallel	5	3	5
Minimum load current [mA]	0		
Residual current (at room temperature when new) [mA]	<0.05	<0.15	<1.5

Proximity sensors SMT-10M, for C-slot

Technical data – Magneto-resistive

Output, additional data	
Protection against short circuit	Yes
Protection against overloading	Yes

Electronic components		
Rated operating voltage	[V DC]	24
Operating voltage range	[V DC]	10 ... 30
Reverse polarity protection	For all electrical connections	

Electromechanical components								
Type SMT-10M	PS/NS				ZS			
Electrical connection	OE	M8D	M8	M12	OE	M8D	M8	M12
Electrical connection	Cable, 3-wire	Cable with plug, 3-pin			Cable, 2-wire	Cable with plug, 2-pin		
		M8x1	M8x1	M12x1		M8x1	M8x1	M12x1
		Rotatable thread	Snap-on flange	Rotatable thread		Rotatable thread	Snap-on flange	Rotatable thread
Connection direction	In-line Lateral							
Cable test conditions	Energy chain: 5 million cycles, bending radius 28 mm Torsional strength: >300,000 cycles, ±270°/Q1 m Resistance to bending: to Festo standard; test conditions on request							
Cable length	[m]	0.2 ... 30						
Cable attribute	Energy chain + robot applications							
Cable sheath materials	TPE-U(PUR)							

Mechanical components	
Type of mounting	Screw-clamped in slot, insertable from above
Max. tightening torque	[Nm] 0.4
Mounting position	Any
Housing	PA reinforced High-alloy stainless steel

Display/operation	
Switching status display	Yellow LED

Immissions/emissions	
Ambient temperature with flexible cable installation	[°C] -20 ... +70
Protection class	IP65 IP68

Proximity sensors SMT-10M, for C-slot

Technical data – Magneto-resistive

Pin allocation to EN 60947-5-2

M8x1, 2-pin			
N/O contact			
	Pin	Wire colour	Allocation
	1	Brown	+
	4	Black	Output

M8x1, 3-pin			
N/O contact			
	Pin	Wire colour	Allocation
	1	Brown	+
	3	Blue	-
	4	Black	Output

Pin allocation to EN 60947-5-2

M12x1, 2-pin			
N/O contact			
	Pin	Wire colour	Allocation
	1	Brown	+
	4	Black	Output

M12x1, 3-pin			
N/O contact			
	Pin	Wire colour	Allocation
	1	Brown	+
	3	Blue	-
	4	Black	Output

Dimensions

Download CAD data → www.festo.com

SMT-10M-...-L, in-line connection

1 Yellow LED 5 Cable with open end 7 Plug M8x1, rotatable thread L1 Cable length
2 SMT-10M 6 Plug M8x1, snap-on flange 8 Plug M12x1
3 Inscription label holder
4 Connecting cable

Type	B1	D1	D2	D3	H1	L2	L3	L4	L5	L6	L7	⊕
SMT-10M-...-OE	2.9	2.15	-	-	4.6	50	22.9	20.9	23	50	7	1.5
SMT-10M-...-M8D			M8x1	8.5		-						
SMT-10M-...-M8			M8x1	9.6		-						
SMT-10M-...-M12			M12x1	15		-						

Proximity sensors SMT-10M, for C-slot

Technical data – Magneto-resistive

Dimensions

Download CAD data → www.festo.com

SMT-10M-...-Q, lateral connection

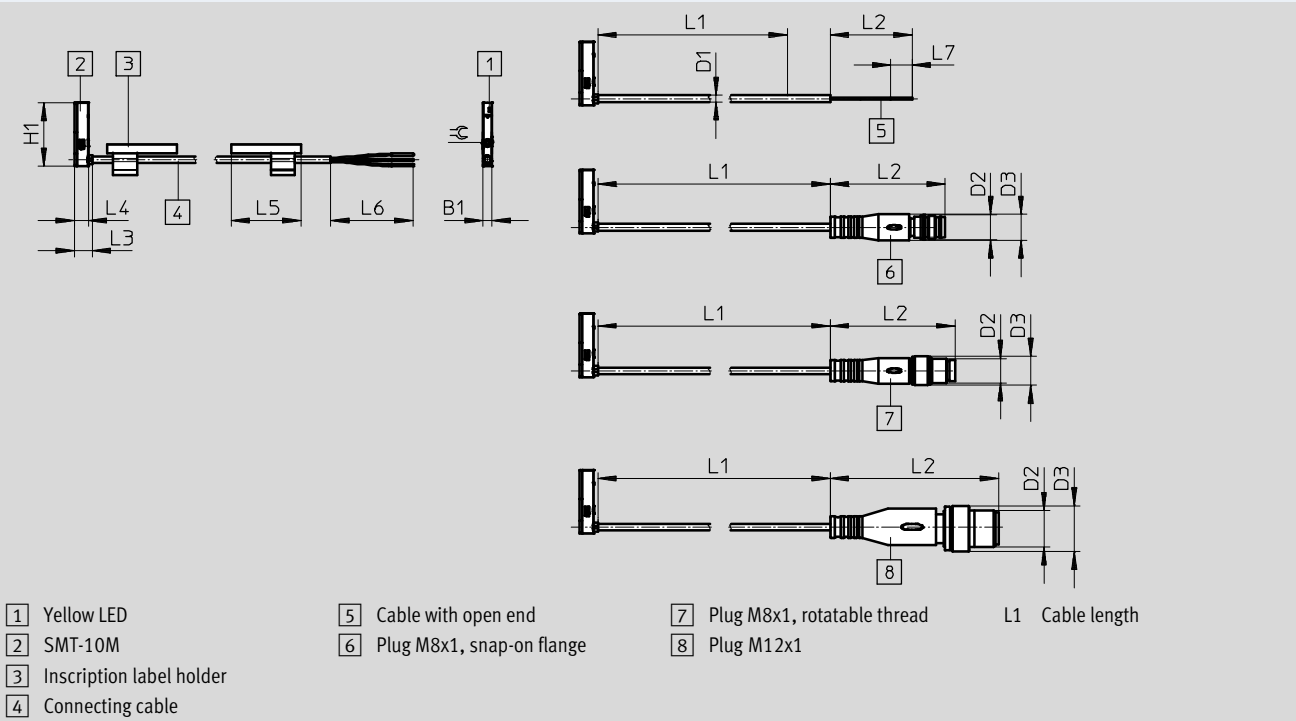

Type	B1	D1	D2	D3	H1	L2	L3	L4	L5	L6	L7	⌀
SMT-10M-...-OE	2.9	2.15	-	-	20.9	50	6	4.6	23	50	7	1.5
SMT-10M-...-M8D			M8x1	8.5		32.7					-	
SMT-10M-...-M8			M8x1	9.6		41.1					-	
SMT-10M-...-M12			M12x1	15		55.5					-	

★ Core product range

Ordering data	Switching output	Electrical connection		Cable length [m]	Weight [g]	Part No.	Type
		Cable	Cable with plug, rotatable thread				
	N/O contact	PNP	3-wire	-	2.5	16.8	★ 551373 SMT-10M-PS-24V-E-2,5-L-OE
			-	M8x1, 3-pin	0.3	6.7	★ 551375 SMT-10M-PS-24V-E-0,3-L-M8D
	NPN	3-wire	-	2.5	16.8	★ 551377 SMT-10M-NS-24V-E-2,5-L-OE	
		-	M8x1, 3-pin	0.3	6.7	★ 551379 SMT-10M-NS-24V-E-0,3-L-M8D	
	Non-contacting, 2-wire	2-wire	-		2.5	14.6	★ 551382 SMT-10M-ZS-24V-E-2,5-L-OE

Festo core product range

- ★ Ready for dispatch from the Festo factory in 24 hours
- ☆ Ready for dispatch in 5 days maximum from stock

Proximity sensors SMT-10M, for C-slot

Technical data – Magneto-resistive

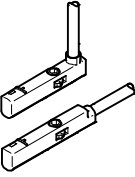
Ordering data							
	Switching output	Electrical connection		Cable length [m]	Weight [g]	Part No.	Type
		Cable	Cable with plug, rotatable thread				
	N/O contact						
	PNP	3-wire	–	2.5	16.8	551374	SMT-10M-PS-24V-E-2,5-Q-OE
		–	M8x1, 3-pin	0.3	6.7	551376	SMT-10M-PS-24V-E-0,3-Q-M8D
	NPN	3-wire	–	2.5	16.8	551378	SMT-10M-NS-24V-E-2,5-Q-OE
		–	M8x1, 3-pin	0.3	6.7	551380	SMT-10M-NS-24V-E-0,3-Q-M8D
	Non-contacting, 2-wire	2-wire	–	2.5	14.6	551383	SMT-10M-ZS-24V-E-2,5-Q-OE

Proximity sensors SMT-10M, for C-slot

Ordering data Modular product system – Magneto-resistive

M Mandatory data						O Options	M	
Module No.	Function	Switching output	Rated operating voltage	Cable attribute	Cable length in m	Cable outlet	Cable designation	Connection technology
551372	SMT-10M	PS NS ZS	24V	E	0.2 ... 30	L Q	N	OE M8D M8 M12
Ordering example								
551372	SMT-10M	- NS	- 24V	- E	- 3	- L	- N	- M8D

Ordering table				
Size	10	Condi-tions	Code	Enter code
M	Module No.	551372		
	Function	Proximity sensor for C-slot, non-contacting	SMT-10M	SMT-10M
			-	-
	Switching output	3-wire PNP N/O contact	PS	
		3-wire NPN N/O contact	NS	
		2-wire N/O contact	ZS	
			-	-
	Rated operating voltage [V DC]	24	24V	24V
			-	-
	Cable attribute	Energy chain + robot applications	E	E
			-	-
	Cable length [m]	0.2 ... 30 (0.2 ... 5.0 m in 0.1 m increments, 5.0 ... 30 m in 0.5 m increments)	...	
			-	-
	Cable outlet	In-line	L	
		Lateral	Q	
			-	-
O	Cable designation	With inscription label holder	-	
		Without inscription label holder	N	
M			-	-
	Connection technology	Open end	OE	
		M8, rotatable thread	M8D	
		M8, snap-on flange	M8	
		M12, rotatable thread	M12	

Transfer order code

551372 SMT-10M - [] - 24V - E - [] - [] - [] - []

Proximity sensors SME-10M, for C-slot

Technical data – Magnetic reed

Function

E.g. N/O contact, 3-wire, with cable

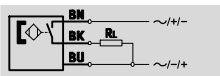

E.g. N/O contact, 3-wire, with plug

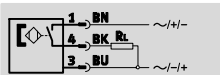

- Magnetic reed measuring principle
- Insertable in slot from above, does not protrude over the cylinder profile
- Cable clip and inscription label holder included in the scope of delivery

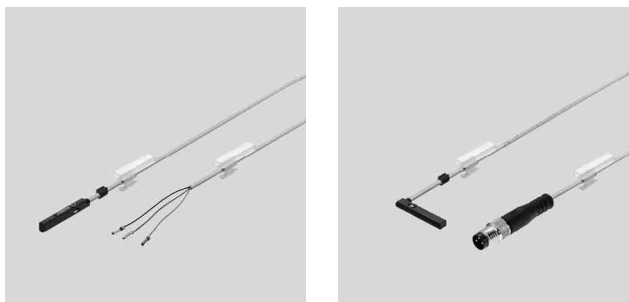

General technical data

Design	For C-slot
Conforms to	EN 60947-5-2
Certification	C-Tick
Special features	Oil resistant
CE mark (see declaration of conformity)	To EU EMC Directive ¹⁾
Note on materials	Cable free of halogen
	Free of copper and PTFE
	RoHS-compliant

1) For information about the applicability of the component see the manufacturer's EC declaration of conformity at: www.festo.com/sp → User documentation.
If the component is subject to restrictions on usage in residential, office or commercial environments or small businesses, further measures to reduce the emitted interference may be necessary.

Input signal/measuring element

Measured variable	Position
Measuring principle	Magnetic reed
Ambient temperature	[°C] -40 ... +70

Switching output

Type SME-10M	DS	ZS
Switching output	Contacting, bipolar	
Switching element function	N/O contact	
Repetition accuracy of switching output in ± mm	[mm] 0.1	
Switch-on time	[ms] 0 ... 1.2	
Switch-off time	[ms] 0 ... 1	
Max. switching frequency	[Hz] 50	
Max. output current	[mA] 300	100
Max. output current in mounting kits	[mA] 50	50
Max. switching capacity AC	[VA] 9	3
Max. switching capacity AC in mounting kits	[VA] 1.5	1.5
Max. switching capacity DC	[W] 9	3
Max. switching capacity DC in mounting kits	[W] 1.5	1.5
Voltage drop	[V] 0 ... 0.5	0 ... 4.5

Output, additional data

Protection against short circuit	No
Protection against overloading	No

Proximity sensors SME-10M, for C-slot

Technical data – Magnetic reed

Electronic components		
Rated operating voltage	[V DC]	24
Operating voltage range AC	[V]	5 ... 30
Operating voltage range DC	[V]	5 ... 30
Reverse polarity protection		No

Electromechanical components								
Type SME-10M	DS				ZS			
Electrical connection	OE	M8D	M8	M12	OE	M8D	M8	M12
Electrical connection	Cable, 3-wire	Cable with plug, 3-pin			Cable, 2-wire	Cable with plug, 2-pin		
		M8x1	M8x1	M12x1		M8x1	M8x1	M12x1
		Rotatable thread	Snap-on flange	Rotatable thread		Rotatable thread	Snap-on flange	Rotatable thread
Connection direction	In-line							
	Lateral							
Cable test conditions	Energy chain: 5 million cycles, bending radius 28 mm							
	Torsional strength: >300,000 cycles, ±270°/Q1 m							
	Resistance to bending: to Festo standard; test conditions on request							
Cable length	[m]	0.2 ... 10						
Cable attribute	Energy chain + robot applications							
Cable sheath materials	TPE-U(PUR)							

Mechanical components	
Type of mounting	Screw-clamped in slot, insertable from above
Max. tightening torque	Q4
Mounting position	Any
Housing	PA reinforced
	High-alloy stainless steel

Display/operation	
Switching status display	Yellow LED

Immissions/emissions		
Ambient temperature with flexible cable installation	[°C]	−20 ... +70
Protection class	IP65	
	IP68	

Pin allocation to EN 60947-5-2			
M8x1, 2-pin			
N/O contact			
	Pin	Wire colour	Allocation
	1	Brown	+
	4	Black	Output
M8x1, 3-pin			
N/O contact			
	Pin	Wire colour	Allocation
	1	Brown	+
	3	Blue	−
	4	Black	Output

Pin allocation to EN 60947-5-2			
M12x1, 2-pin			
N/O contact			
	Pin	Wire colour	Allocation
	1	Brown	+
	4	Black	Output
M12x1, 3-pin			
N/O contact			
	Pin	Wire colour	Allocation
	1	Brown	+
	3	Blue	−
	4	Black	Output

Proximity sensors SME-10M, for C-slot

Technical data – Magnetic reed

Dimensions

Download CAD data → www.festo.com

SME-10M-...-L, in-line connection

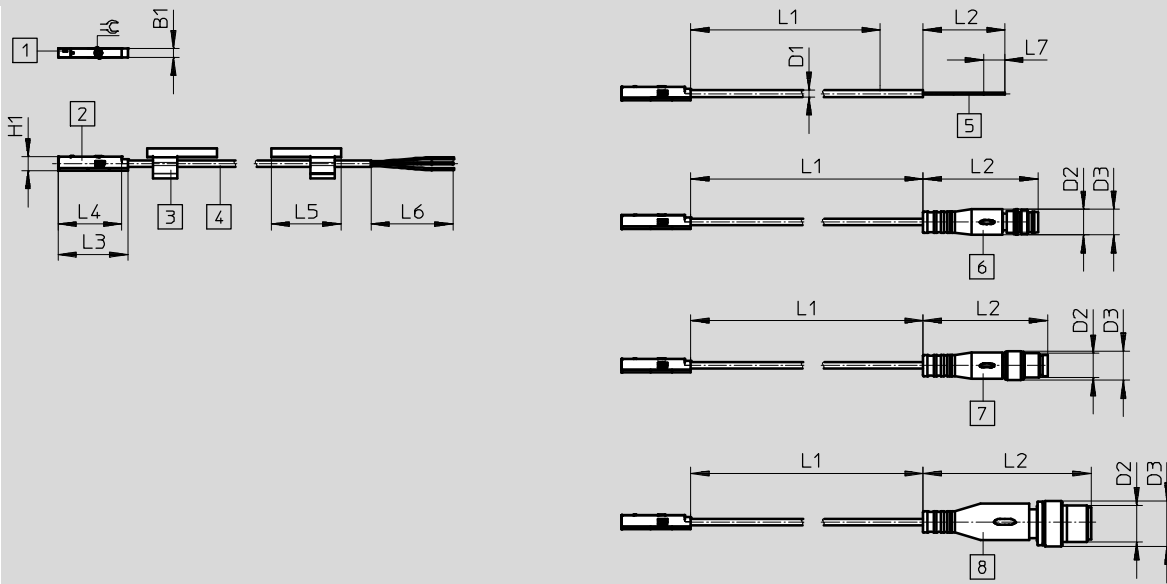

- 1 Yellow LED
- 2 SME-10M
- 3 Inscription label holder
- 4 Connecting cable
- 5 Cable with open end
- 6 Plug M8x1, snap-on flange
- 7 Plug M8x1, rotatable thread
- 8 Plug M12x1
- L1 Cable length

Type	B1	D1	D2	D3	H1	L2	L3	L4	L5	L6	L7	⌀
SME-10M-...-OE	3	2.15	-	-	4.6	50	26.6	24.6	23	50	7	1.5
SME-10M-...-M8D			M8x1	8.5		32.7					-	
SME-10M-...-M8			M8x1	9.6		41.1					-	
SME-10M-...-M12			M12x1	15		55.5					-	

Proximity sensors SME-10M, for C-slot

Technical data – Magnetic reed

Dimensions

Download CAD data → www.festo.com

SME-10M-...-Q, lateral connection

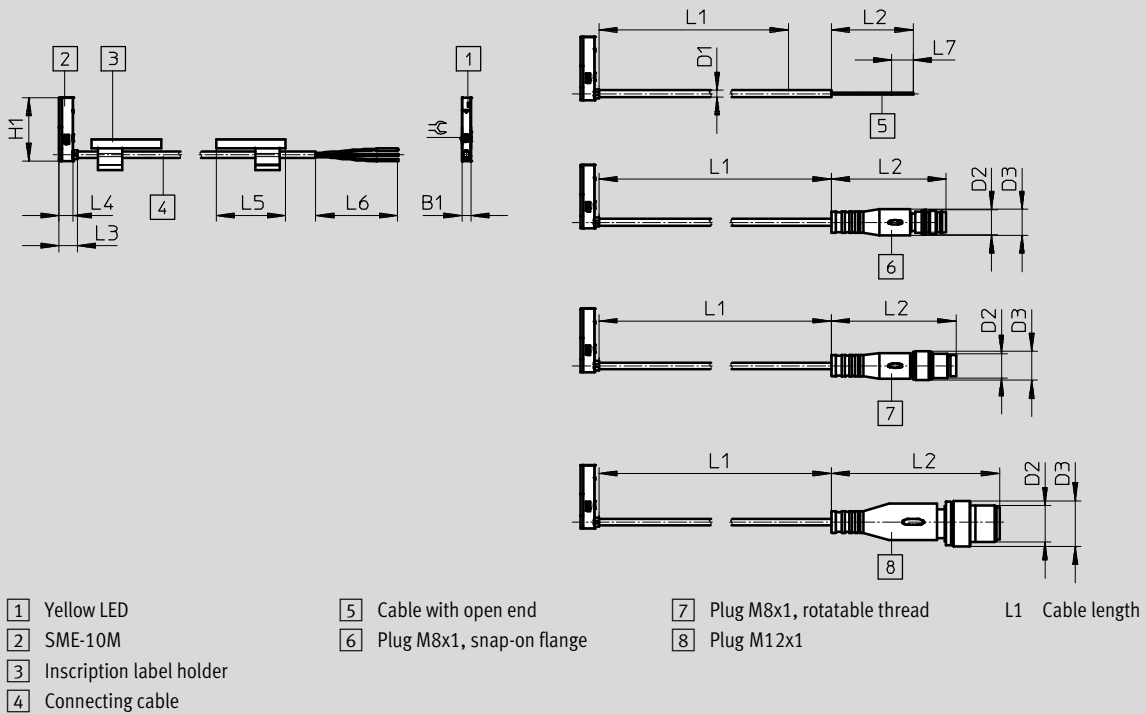

Type	B1	D1	D2	D3	H1	L2	L3	L4	L5	L6	L7	☞
SME-10M-...-OE	3	2.15	-	-	24.6	50	6	4.6	23	50	7	1.5
SME-10M-...-M8D			M8x1	8.5		32.7					-	
SME-10M-...-M8			M8x1	9.6		41.1					-	
SME-10M-...-M12			M12x1	15		55.5					-	

Ordering data

	Switching output	Electrical connection		Cable length [m]	Weight [g]	Part No.	Type
		Cable	Cable with plug, rotatable thread				
	N/O contact						
	Contacting, bipolar	3-wire	-	2.5	16.8	★ 551365	SME-10M-DS-24V-E-2,5-L-OE
		-	M8x1, 3-pin	0.3	6.7	★ 551367	SME-10M-DS-24V-E-0,3-L-M8D
	2-wire	-	2.5	14.6	★ 551369	SME-10M-ZS-24V-E-2,5-L-OE	

Festo core product range

★ Ready for dispatch from the Festo factory in 24 hours

☆ Ready for dispatch in 5 days maximum from stock

Proximity sensors SME-10M, for C-slot

Technical data – Magnetic reed

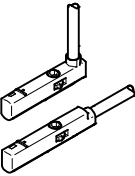
Ordering data							
	Switching output	Electrical connection		Cable length [m]	Weight [g]	Part No.	Type
		Cable	Cable with plug, rotatable thread				
	N/O contact						
	Contacting, bipolar	3-wire	–	2.5	16.8	551366	SME-10M-DS-24V-E-2,5-Q-OE
		–	M8x1, 3-pin	0.3	6.7	551368	SME-10M-DS-24V-E-0,3-Q-M8D
		2-wire	–	2.5	14.6	551370	SME-10M-ZS-24V-E-2,5-Q-OE

Proximity sensors SME-10M, for C-slot

Ordering data Modular products – Magnetic reed

M Mandatory data							O Options	M
Module No.	Function	Switching output	Rated operating voltage	Cable attribute	Cable length in m	Cable outlet	Cable designation	Connection technology
551364	SME-10M	DS ZS	24V	E	0.2 ... 10	L Q	N	OE M8D M8 M12
Ordering example								
551364	SME-10M	- DS	- 24V	- E	- 3	- L	- N	- M8D

Ordering table				
Size	10	Condi-tions	Code	Enter code
M	Module No.	551364		
	Function	Proximity sensor for C-slot, contacting	SME-10M	SME-10M
			-	-
	Switching output	3-wire N/O contact	DS	
	Switching output	2-wire N/O contact	ZS	
			-	-
	Rated operating voltage [V DC]	24	24V	24V
			-	-
	Cable attribute	Energy chain + robot applications	E	E
			-	-
	Cable length [m]	0.2 ... 10 (0.2 ... 5.0 m in 0.1 m increments, 5.0 ... 10 m in 0.5 m increments)	...	
			-	-
	Cable outlet	In-line	L	
		Lateral	Q	
			-	-
O	Cable designation	With inscription label holder	-	
		Without inscription label holder	N	
			-	-
M	Connection technology	Open end	OE	
		M8, rotatable thread	M8D	
		M8, snap-on flange	M8	
		M12, rotatable thread	M12	

Transfer order code

551364 - SME-10M - [] - 24V - E - [] - [] - [] - []

Proximity sensors SME-10, for C-slot

Type codes

SME-10

SME – 10 – KL – LED – 24

Function

SME	Proximity sensor, magnetic reed
-----	---------------------------------

Design

10	For C-slot, insertable in slot lengthwise
----	---

Electrical connection, cable length, connection direction

KL	Cable, 2.5 m, in-line
KQ	Cable, 2.5 m, lateral
SL	Plug M8x1 with cable, 0.3 m, in-line
SQ	Plug M8x1 with cable, 0.3 m, lateral

Switching status display

LED	Yellow LED
-----	------------

Rated operating voltage

24	24 V DC
----	---------

Proximity sensors SME-10, for C-slot

Technical data – Magnetic reed

Function

NO contact, 3-wire, with cable

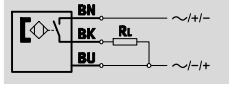

N/O contact, 3-wire, with plug

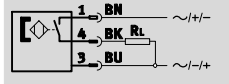

- Magneto-resistive measuring principle
- Insertable in the slot lengthwise

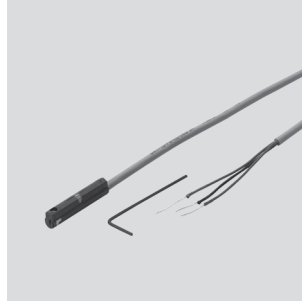

General technical data	
Design	For C-slot
Conforms to	EN 60947-5-2
Certification	RCM trademark
CE mark (see declaration of conformity)	To EU EMC Directive
Note on materials	Free of copper and PTFE

Input signal/measuring element	
Measuring principle	Magnetic reed
Ambient temperature [°C]	-20 ... +70

Switching output	
Switching output	Contacting, bipolar
Switching element function	N/O contact
Reproducibility of switching value [mm]	±0.1
Switch-on time [ms]	≤0.6
Switch-off time [ms]	≤0.05
Max. output current [mA]	100
Max. switching frequency [Hz]	500
Max. switching capacity DC [W]	1
Voltage drop [V]	0

Output, additional data	
Protection against short circuit	No
Protection against overloading	No

Electronic components	
Operating voltage range DC [V]	12 ... 27
Operating voltage range AC [V]	12 ... 27
Reverse polarity protection	No

Electromechanical components		
Type	SME-10-...-K...-	SME-10-...-S...-
Electrical connection	Cable, 3-wire	Cable with plug M8x1, 3-pin
Connection direction	In-line, lateral	In-line, lateral
Cable length [m]	2.5	0.3
Information on cable sheath materials	TPE-U (PUR)	

Proximity sensors SME-10, for C-slot

Technical data – Magnetic reed

Mechanical components		
Type	SME-10-...-K...-...	SME-10-...-S...-...
Type of mounting	Clamped in C-slot, insertable in the slot lengthwise	
Tightening torque	[Nm]	0.18
Information on housing materials	PPS, high-alloy stainless steel	PPS, TPE-U(PU), high-alloy stainless steel, nickel-plated brass

Display/operation	
Switching status display	Yellow LED

Immissions/emissions		
Ambient temperature with flexible cable installation	[°C]	-5 ... +70
Protection class		IP65
		IP67
Insulation voltage	[V]	50
Surge capacity	[kV]	0.8
Degree of contamination		3

Pin allocation to EN 60947-5-2			
Plug, 3-pin			
M8x1	Pin	Wire colour	Allocation
	1	Brown	+
	3	Blue	-
	4	Black	Output

Proximity sensors SME-10, for C-slot

Technical data – Magnetic reed

Dimensions Download CAD data → www.festo.com

Cable, in-line connection



Type	B1	B2	D1	H1	L3	L4
SME-10-KL-LED-24	3.7	2.9	2.4 ∅	4.3	+0.4	11

Dimensions Download CAD data → www.festo.com

Cable, lateral connection

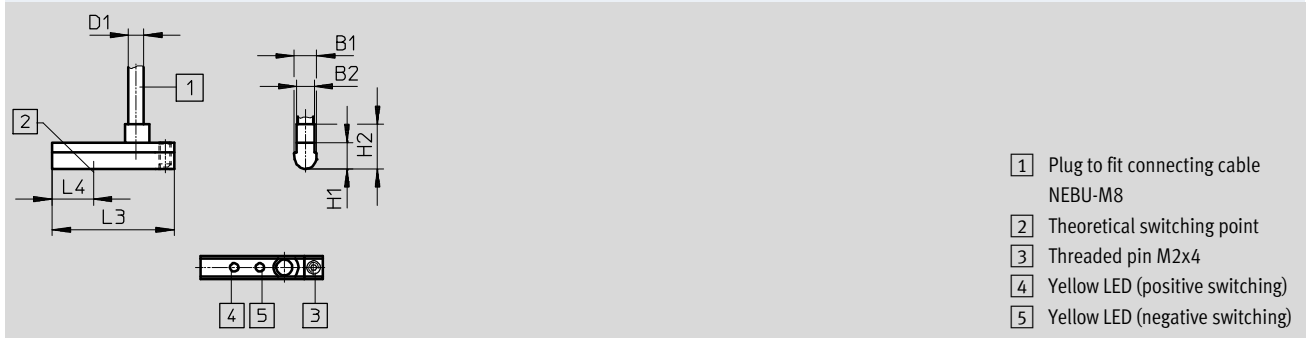

Type	B1	B2	D1	H1	H2	L3	L4
SME-10-KQ-LED-24	3.7	2.9	2.4 ∅	4.3	7.3	+0.4	6.8

Proximity sensors SME-10, for C-slot

Technical data – Magnetic reed



Dimensions

Download CAD data → www.festo.com

Cable, in-line connection

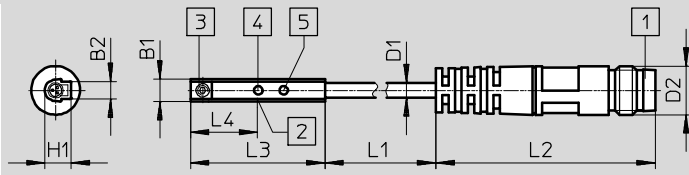

- 1 Plug to fit connecting cable NEBU-M8
- 2 Theoretical switching point
- 3 Threaded pin M2x4
- 4 Yellow LED (positive switching)
- 5 Yellow LED (negative switching)

Type	B1	B2	D1	D2	H1	L1	L2	L3	L4
SME-10-SL-LED-24	3.7	2.9	2.4	M8	4.3	310	±1	+0.4	11

Dimensions

Download CAD data → www.festo.com

Plug M8x1, lateral connection

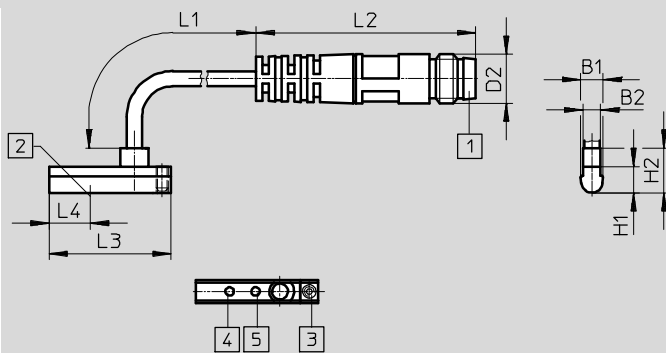

- 1 Plug to fit connecting cable NEBU-M8
- 2 Theoretical switching point
- 3 Threaded pin M2x4
- 4 Yellow LED (positive switching)
- 5 Yellow LED (negative switching)

Type	B1	B2	D2	H1	H2	L1	L2	L3	L4
SME-10-SQ-LED-24	3.7	2.9	M8	4.3	7.3	-10 ... 30	±1	+0.4	6.8

Ordering data

	Switching output	Electrical connection		Cable length [m]	Part No.	Type
		Cable	Cable with plug, M8x1			
In-line connection						
	N/O contact					
	Contacting, bipolar	3-wire	–	2.5	173210	SME-10-KL-LED-24
–		3-pin	0.3	173212	SME-10-SL-LED-24	
Lateral connection						
	N/O contact					
	Contacting, bipolar	3-wire	–	2.5	173211	SME-10-KQ-LED-24
		–	3-pin	0.3	173213	SME-10-SQ-LED-24

Proximity sensors SMT-10G, for C-slot

Type codes

SMT-10G

		SMT	-	10G	-		-	24V	-	E	-		-	
Function														
SMT	Proximity sensor, magneto-resistive													
Design														
10G	For C-slot, insertable in slot lengthwise													
Switching output, switching element function														
PS	PNP, N/O contact, 3-wire													
NS	NPN, N/O contact, 3-wire													
Rated operating voltage														
24V	24 V DC													
Cable properties														
E	Energy chain + robot applications													
Cable length [m], connection direction														
2,5Q	Cable, 2.5 m, lateral ¹⁾													
0,3Q	Cable with plug, 0.3 m, lateral ²⁾													
Electrical connection														
OE	Open end													
M8D	Cable with plug M8x1, rotatable thread													

- 1) Only with electrical connection OE
- 2) Not with electrical connection OE

Proximity sensors SMT-10G, for C-slot

Technical data – Magneto-resistive

Function

PNP, N/O contact, with cable, 3-wire

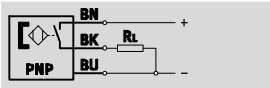

PNP, N/O contact, with plug

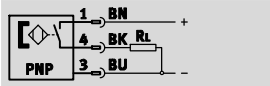

NPN, N/O contact, with cable, 3-wire

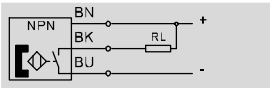

NPN, N/O contact, with plug

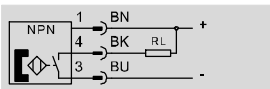

- Magneto-resistive measuring principle
- Insertable in slot lengthwise
- Design ideally matched to gripper sensing

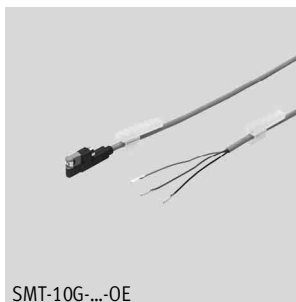

SMT-10G-...-OE



SMT-10G-...-M

General technical data

Design	For C-slot
Based on standard	EN 60947-5-2
Certification	c UL us - Listed (OL)
CE mark (see declaration of conformity)	To EU EMC Directive
Note on materials	Free of copper and PTFE RoHS-compliant

Input signal/measuring element

Measuring principle	Magneto-resistive
Ambient temperature	[°C] -20 ... +70

Switching output

	PNP	NPN
Switching element function	N/O contact	
Max. output current	[mA] 100	
Max. switching capacity DC	[W] 2.8	

Output, additional data

Protection against short circuit	Pulsed
Protection against overloading	Yes

Proximity sensors SMT-10G, for C-slot

Technical data – Magneto-resistive

Electronic components		
Operating voltage range	[V DC]	10 ... 30
Reverse polarity protection		For all electrical connections

Electromechanical components		
Type	SMT-10G-...-OE	SMT-10G-...-M8D
Electrical connection	Cable, 3-wire	Cable with plug M8x1, 3-pin, rotatable thread
Connection direction	Lateral	
Cable test conditions	Energy chain: 5 million cycles, bending radius 28 mm	
	Torsional strength: > 300,000 cycles, ±270°/0.1 m	
	Resistance to bending: to Festo standard; test conditions on request	
Cable length	[m]	2.5 0.3
Cable properties	Energy chain + robot applications	
Cable sheath material	Thermoplastic polyurethane elastomer	

Mechanical components	
Type of mounting	Clamped in C-slot
	Insertable in slot lengthwise
Housing material	Reinforced polyamide

Display/operation	
Switching status display	Yellow LED

Immissions/emissions	
Ambient temperature with flexible cable installation	[°C] -5 ... +70
Protection class	IP65
	IP68

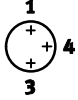
Pin allocation to EN 60947-5-2			
PS			
Plug, 3-pin			
M8x1	Pin	Wire colour	Allocation
	1	Brown	+
	3	Blue	-
	4	Black	Output

Proximity sensors SMT-10G, for C-slot

Technical data – Magneto-resistive



Dimensions

Download CAD data → www.festo.com

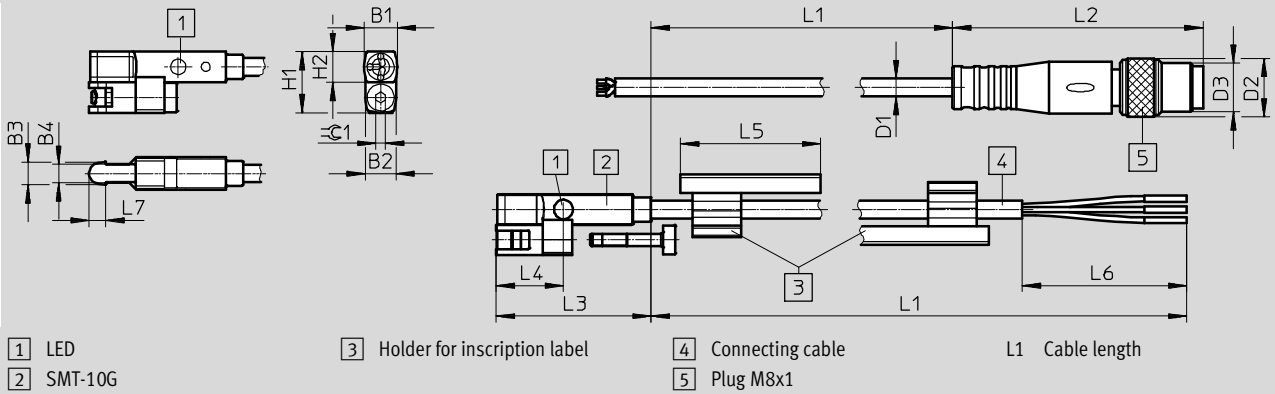

	B1	B2	B3	B4	D1 ∅	D2 ∅	D3	H1	H2	L1	L2 ±0.4	L3 ±0.3	L4	L5	L6 +5	L7	≈
SMT-10G-PS-...-OE	5.4	5	6.3	5	2.9	-	-	10	5	2500 + 70	-	25	10.8	23	50	2.5	1.5
SMT-10G-PS-...-M8D						9.6	M8x1			300 + 30	41.1				-		
SMT-10G-NS-...-OE						-	-			2500 + 70	-				50		
SMT-10G-NS-...-M8D						9.6	M8x1			300 + 30	41.1				-		

Ordering data

	Switching output	Electrical connection		Cable length [m]	Part No.	Type
		Cable	Cable with plug, rotatable thread, M8x1			
N/O contact						
	PNP	3-wire	-	2.5	547862	SMT-10G-PS-24V-E-2,5Q-OE
		-	3-pin	0.3	547863	SMT-10G-PS-24V-E-0,3Q-M8D
	NPN	3-wire	-	2.5	8065030	SMT-10G-NS-24V-E-2,5Q-OE
		-	3-pin	0.3	8065029	SMT-10G-NS-24V-E-0,3Q-M8D

Proximity sensors SMT/SME-10, for C-slot

Accessories

Mounting SMBN-10

for mounting proximity sensors
SME/SMT-10 on drives with T-slot

Materials:

Rail: Anodised wrought aluminium alloy

Screws: High-alloy stainless steel

Note on materials:

Free of copper and PTFE

RoHS-compliant

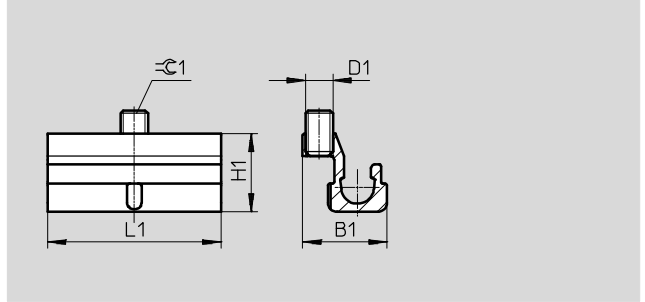

Dimensions and ordering data

For piston \varnothing	D1	B1	H1	L1	\varnothing 1	Part No.	Type
125 ... 320	M3	9.3	8.6	19	1.5	537809	SMBN-10

Positioning component SMM

Insertable in slot lengthwise

Ambient temperature: $-40 \dots +120 \text{ }^\circ\text{C}$

Materials:

Housing: Anodised wrought aluminium alloy

Screws: High-alloy stainless steel

Note on materials:

RoHS-compliant

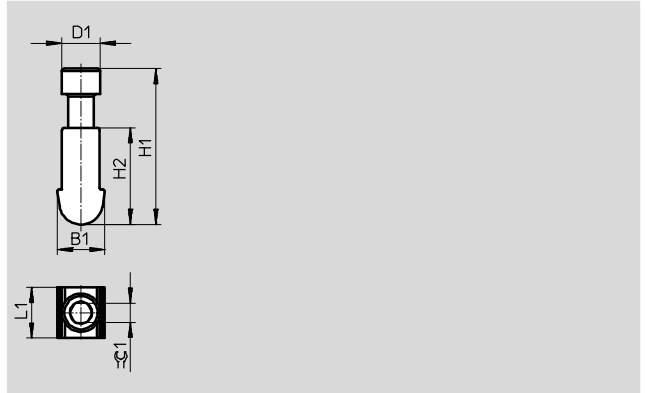

Dimensions and ordering data

B1	D1	H1	H2	L1	\varnothing 1	CRC ¹⁾	Part No.	Type	PU ²⁾
3.75	3.0	12.23	7.6	4.0	1.5	3	547942	SMM-10	10

1) Corrosion resistance class 4 according to Festo standard 940 070



Components subject to particularly high corrosion stress. Parts used with aggressive media, e.g. in the food or chemical industry. These applications should be supported with special tests with the media if required.



2) Packaging unit

Proximity sensors SMT/SME-10, for C-slot

Accessories

FESTO

Ordering data – Connecting cables					Technical data → Internet: nebu	
	Type	Number of wires	Cable length [m]	Part No.	Type	
Socket M8x1, 3-pin						
	For SMT/SME-10...	3	2.5	★ 541333	NEBU-M8G3-K-2.5-LE3	
			5	★ 541334	NEBU-M8G3-K-5-LE3	
	For SMT/SME-10...	3	2.5	★ 541338	NEBU-M8W3-K-2.5-LE3	
			5	★ 541341	NEBU-M8W3-K-5-LE3	

Ordering data – Mounting components				
	For Ø	Description	Part No.	Type
	6	Mounting kit for mounting proximity sensors on swivel module DSM	173205	WSM-6-SME-10
	8		173206	WSM-8-SME-10
	10		173207	WSM-10-SME-10
	–	For locating connecting cables	534255	SMBK-10

Ordering data – Safety clips for ATEX zone					
	Size	Description	Part No.	Type	PU ¹⁾
	M8	<ul style="list-style-type: none"> Protects "equipment that is not intrinsically safe" in zones 2 and 22 against simple disconnection ATEX category: gas: II 3G / dust: II 3D 	548067	NEAU-M8-GD	1
	M12		548068	NEAU-M12-GD	1

1) Packaging unit

Ordering data – Sensor tester			
	Description	Part No.	Type
	<ul style="list-style-type: none"> Testing operation of proximity sensors using the integrated voltage supply Adjustment of proximity sensors on the cylinder 	158481	SM-TEST-1

Ordering data – Inscription labels				
	Size	Part No.	Type	PU ¹⁾
	23x4 mm	541598	ASLR-L-423	34

1) Packaging unit

Festo core product range

- ★ Generally ready for shipping ex works in 24 hours
- ☆ Generally ready for shipping ex works in 5 days

Festo - Your Partner in Automation



1 Festo Inc.
5300 Explorer Drive
Mississauga, ON L4W 5G4
Canada

Festo Customer Interaction Center
Tel: 1 877 463 3786
Fax: 1 877 393 3786
Email: customer.service.ca@festo.com



2 Festo Pneumatic
Av. Ceylán 3,
Col. Tequesquináhuac
54020 Tlalnepantla,
Estado de México

Multinational Contact Center
01 800 337 8669
ventas.mexico@festo.com



3 Festo Corporation
1377 Motor Parkway
Suite 310
Islandia, NY 11749

Festo Customer Interaction Center
1 800 993 3786
1 800 963 3786
customer.service.us@festo.com



4 Regional Service Center
7777 Columbia Road
Mason, OH 45040

Connect with us



www.festo.com/socialmedia



www.festo.com

Subject to change