

Accessory for SIRIUS 3RM1 3-phase busbar for 2 motor starters Modular spacing 22.5 mm Screw connection system

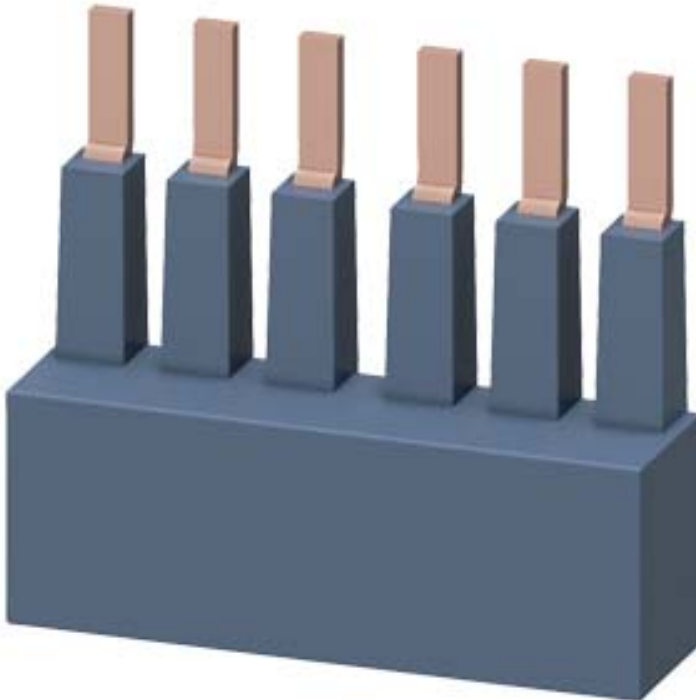

General technical data		
Product brand name		SIRIUS
Product designation		3-phase busbar
Design of the product		For 2 motor starters
Suitability for use		Motor starter 3RM1
Product function Short circuit protection		No
Installation altitude at height above sea level maximum	m	2 000
Ambient temperature		
• during operation	°C	-25 ... +60
• during transport	°C	-40 ... +70
• during storage	°C	-40 ... +70
Insulation voltage rated value	V	500
Reference code acc. to DIN EN 81346-2		X

Safety related data		
Protection against electrical shock		finger-safe





### Main circuit

Relative symmetrical tolerance of the operating voltage	%	10
Ampacity maximum	A	25
Operating current at AC at 480 V acc. to UL 508	A	16

#### Installation/ mounting/ dimensions

Mounting position		any
Mounting type		screw fixing
Width	mm	46
Height	mm	41
Depth	mm	12

#### Certificates/ approvals

General Product Approval	EMC	Declaration of Conformity
 CSA	 UL	 EAC
	 RCM	 EG-Konf.
		<a href="#">Miscellaneous</a>

Test Certificates	other	Railway
<a href="#">Type Test Certificates/Test Report</a>	<a href="#">Confirmation</a>	<a href="#">Special Test Certificate</a>

#### Further information

**Information- and Downloadcenter (Catalogs, Brochures,...)**

<https://www.siemens.com/ic10>

**Industry Mall (Online ordering system)**

<https://mall.industry.siemens.com/mall/en/en/Catalog/product?mlfb=3RM1910-1AA>

**Cax online generator**

<http://support.automation.siemens.com/WW/CAXorder/default.aspx?lang=en&mlfb=3RM1910-1AA>

**Service&Support (Manuals, Certificates, Characteristics, FAQs,...)**

<https://support.industry.siemens.com/cs/ww/en/ps/3RM1910-1AA>

**Image database (product images, 2D dimension drawings, 3D models, device circuit diagrams, EPLAN macros, ...)**

[http://www.automation.siemens.com/bilddb/cax\\_de.aspx?mlfb=3RM1910-1AA&lang=en](http://www.automation.siemens.com/bilddb/cax_de.aspx?mlfb=3RM1910-1AA&lang=en)

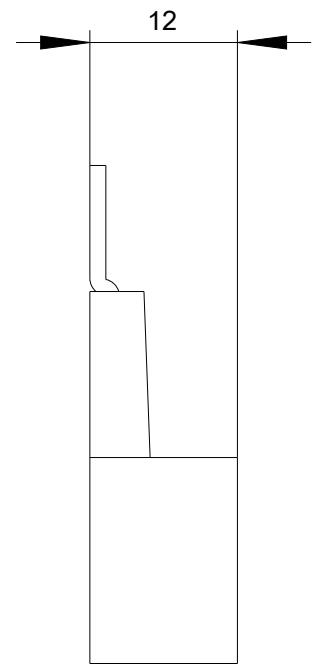
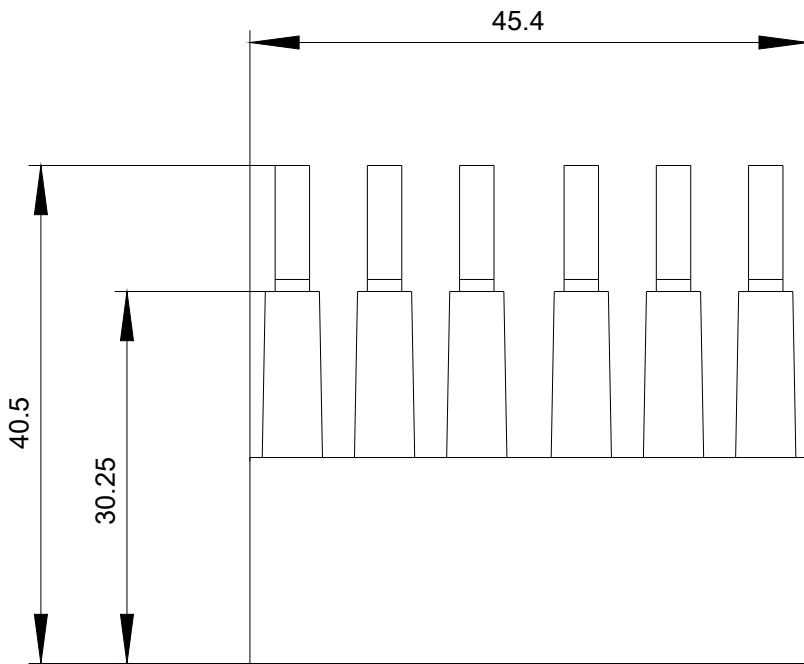

last modified:

03/10/2020