

RH Series Compact Power Relays

Key features

- SPDT through 4PDT, 10A contacts
- Compact power type relays
- Miniature power relays with a large capacity
- 10A contact capacity
- Compact size saves space

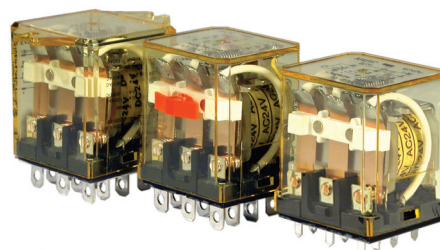

Part Number Selection

Contact	Model	Part Number		Coil Voltage Code (Standard Stock in bold)	
		Blade Terminal	PCB Terminal		
 SPDT	Standard	RH1B-U □	RH1V2-U □	AC6V, AC12V, AC24V , AC110V, AC120V , AC220V, AC240V DC6V, DC12V, DC24V , DC48V, DC110V	
	With Indicator	RH1B-UL □	—		
	With Check Button	RH1B-UC □	—		
	With Indicator and Check Button	RH1B-ULC □	—		
	Top Bracket Mounting	RH1B-UT □	—		
	With Diode (DC coil only)	RH1B-UD □	RH1V2-UD □		DC6V, DC12V, DC24V , DC48V, DC110V
	With Indicator and Diode (DC coil only)	RH1B-ULD □	—		DC12V, DC24V , DC48V, DC110V
 DPDT	Standard	RH2B-U □	RH2V2-U □	AC6V, AC12V, AC24V, AC110-120V , AC220-240V DC6V, DC12V, DC24V , DC48V, DC100-110V	
	With Indicator	RH2B-UL □	RH2V2-UL □		
	With Check Button	RH2B-UC □	—		
	With Indicator and Check Button	RH2B-ULC □	—		
	Top Bracket Mounting	RH2B-UT □	—		
	With Diode (DC coil only)	RH2B-UD □	RH2V2-UD □		DC6V, DC12V, DC24V , DC48V, DC100-110V
	With Indicator and Diode (DC coil only)	RH2B-ULD □	RH2V2-ULD □		
 3PDT	Standard	RH3B-U □	RH3V2-U □	AC6V, AC12V, AC24V , AC110V, AC120V , AC220V, AC240V DC6V, DC12V, DC24V , DC48V, DC110V	
	With Indicator	RH3B-UL □	RH3V2-UL □		
	With Check Button	RH3B-UC □	—		
	With Indicator and Check Button	RH3B-ULC □	—		
	Top Bracket Mounting	RH3B-UT □	—		
	With Diode (DC coil only)	RH3B-UD □	—		DC6V, DC12V, DC24V, DC48V, DC110V
	With Indicator and Diode (DC coil only)	RH3B-ULD □	—		
 4PDT	Standard	RH4B-U □	RH4V2-U □	AC6V, AC12V, AC24V , AC110V, AC120V , AC220V, AC240V DC6V, DC12V, DC24V , DC48V, DC110V	
	With Indicator	RH4B-UL □	RH4V2-UL □		
	With Check Button	RH4B-UC □	—		
	With Indicator and Check Button	RH4B-ULC □	—		
	Top Bracket Mounting	RH4B-UT □	—		
	With Diode (DC coil only)	RH4B-UD □	RH4V2-UD □		DC6V, DC12V, DC24V, DC48V, DC110V
	With Indicator and Diode (DC coil only)	RH4B-ULD □	—		



PCB terminal relays are designed to mount directly to a circuit board without any socket.

Ordering Information

When ordering, specify the Part No. and coil voltage code:

(example) **RH3B-U** **AC120V**
 Part No. Coil Voltage Code

Switches & Pilot Lights

Signaling Lights

Relays & Sockets

Timers

Contactors

Terminal Blocks

Circuit Breakers

Switches & Pilot Lights

Sockets (for Blade Terminal Models)

Relays	Standard DIN Rail Mount ¹	Finger-safe DIN Rail Mount ¹	Through Panel Mount	PCB Mount
RH1B	SH1B-05	SH1B-05C	SH1B-51	SH1B-62
RH2B	SH2B-05	SH2B-05C	SH2B-51	SH2B-62
RH3B	SH3B-05	SH3B-05C	SH3B-51	SH3B-62
RH4B	SH4B-05	SH4B-05C	SH4B-51	SH4B-62



1. DIN Rail mount socket comes with two horseshoe clips. Do not use unless you plan to insert pullover wire spring. Replacement horseshoe clip part number is Y778-011.

Signaling Lights

Hold Down Springs & Clips

Appearance	Item	Relay	For DIN Mount Socket	For Through Panel & PCB Mount Socket
	Pullover Wire Spring	RH1B	SY2S-02F1 ²	SY4S-51F1
		RH2B	SY4S-02F1 ²	
		RH3B	SH3B-05F1 ²	
		RH4B	SH4B-02F1 ²	
	Leaf Spring (side latch)	RH1B, RH2B, RH3B, RH4B	SFA-202 ³	SFA-302 ³
	Leaf Spring (top latch)	RH1B, RH2B, RH3B, RH4B	SFA-101 ³	SFA-301 ³



2. Must use horseshoe clip when mounting in DIN mount socket. Replacement horseshoe clip part number is Y778-011.
3. Two required per relay.

Relays & Sockets

AC Coil Ratings

Voltage (V)	Rated Current (mA) ±15% at 20°C								Coil Resistance (Ω) ±10% at 20°C				Operation Characteristics (against rated values at 20°C)		
	AC 50Hz				AC 60Hz				SPDT	DPDT	3PDT	4PDT	Max. Continuous Applied Voltage	Pickup Voltage	Dropout Voltage
	SPDT	DPDT	3PDT	4PDT	SPDT	DPDT	3PDT	4PDT							
6	170	240	330	387	150	200	280	330	18.8	9.4	6.4	5.4			
12	86	121	165	196	75	100	140	165	76.8	39.3	25.3	21.2			
24	42	60.5	81	98	37	50	70	83	300	153	103	84.5			
110	9.6	—	18.1	21.6	8.4	—	15.5	18.2	6,950	—	2,200	1,800			
110-120	—	9.4-10.8	—	—	—	8.0-9.2	—	—	—	—	—	—			
120	8.6	—	16.4	19.5	7.5	—	14.2	16.5	8,100	—	10,800	7,360			
220	4.7	—	8.8	10.7	4.1	—	7.7	9.1	25,892	—	10,800	7,360			
220-240	—	4.7-5.4	—	—	—	4.0-4.6	—	—	—	18,820	—	—			
240	4.9	—	8.2	9.8	4.3	—	7.1	8.3	26,710	—	12,100	9,120			

Timers

Contactors

DC Coil Ratings

Voltage (V)	Rated Current (mA) ±15% at 20°C				Coil Resistance (Ω) ±10% at 20°C				Operation Characteristics (against rated values at 20°C)		
	SPDT	DPDT	3PDT	4PDT	SPDT	DPDT	3PDT	4PDT	Max. Continuous Applied Voltage	Pickup Voltage	Dropout Voltage
6	128	150	240	250	47	40	25	24	110%	80% maximum	10% minimum
12	64	75	120	125	188	160	100	96			
24	32	36.9	60	62	750	650	400	388			
48	18	18.5	30	31	2,660	2,600	1,600	1,550			
100-110	—	8.2-9.0	—	—	—	12,250	—	—			
110	8	—	12.8	15	13,800	—	8,600	7,340			



Standard coil voltages are in **BOLD**.

Terminal Blocks

Circuit Breakers

Contact Ratings

Model	Continuous Current	Maximum Contact Capacity				
		Allowable Contact Power		Rated Load		
		Resistive Load	Inductive Load	Voltage (V)	Res. Load	Ind. Load
SPDT	10A	1540VA 300W	990VA 210W	110 AC	10A	7A
				220 AC	7A	4.5A
				30 DC	10A	7A
DPDT 3PDT 4PDT	10A	1650VA 300W	1100VA 225W	110 AC	10A	7.5A
				220 AC	7.5A	5A
				30 DC	10A	7.5A

Note: Inductive load for the rated load — $\cos \phi = 0.3$, L/R = 7 ms

TÜV Ratings

Voltage	RH1	RH2	RH3	RH4
240V AC	10A	10A	7.5A	7.5A
30V DC	10A	10A	10A	10A

AC: $\cos \phi = 1.0$, DC: L/R = 0 ms

UL Ratings

Voltage	Resistive			General Use			Horsepower Rating		
	RH1 RH2	RH3	RH4	RH1 RH2	RH3	RH4	RH1 RH2	RH3	RH4
240V AC	10A	7.5A	7.5A	7A	6.5A	5A	1/3 HP	1/3 HP	—
120V AC	—	10A	10A	—	7.5A	7.5A	1/6 HP	1/6 HP	—
30V DC	10A	10A	—	7A	—	—	—	—	—
28V DC	—	—	10A	—	—	—	—	—	—



CSA Ratings

Voltage	Resistive				General Use				Horsepower Rating
	RH1	RH2	RH3	RH4	RH1	RH2	RH3	RH4	RH1, 2, 3
240V AC	10A	10A	—	7.5A	7A	7A	7A	5A	1/3 HP
120V AC	10A	10A	10A	10A	7.5A	7.5A	—	7.5A	1/6 HP
30V DC	10A	10A	10A	10A	7A	7.5A	—	—	—

Socket Specifications

	Sockets	Terminal	Electrical Rating	Wire Size	Torque	
DIN Rail Mount Sockets	SH1B-05	(Coil) M3 screws (contact) M3.5 screws with captive wire clamp	250V, 10A	Maximum up to 2-#12AWG	5.5 - 9 in•lbs 9 - 11.5 in•lbs	
	SH2B-05 SH3B-05 SH4B-05	M3.5 screws with captive wire clamp	300V, 10A	Maximum up to 2-#12AWG	9 - 11.5 in•lbs	
	Finger-safe DIN Rail Mount	SH1B-05C	(coil) M3 screws (contact) M3.5 screws with captive wire clamp, fingersafe	250V, 10A	Maximum up to 2-#12AWG	5.5 - 9 in•lbs 9 - 11.5 in•lbs
		SH2B-05C SH3B-05C SH4B-05C	M3.5 screws with captive wire clamp, fingersafe	300V, 10A	Maximum up to 2-#12AWG	9 - 11.5 in•lbs
Through Panel Mount Socket	SH1B-51 SH2B-51 SH3B-51 SH4B-51	Solder	300V, 10A	—	—	
PCB Mount Socket	SH1B-62	PCB mount	250V, 10A	—	—	
	SH2B-62 SH3B-62 SH4B-62	PCB mount	300V, 10A	—	—	

Accessories

Item	Appearance	Use with	Part No.	Remarks
Aluminum DIN Rail (1 meter length)		All DIN rail sockets	BNDN1000	The BNDN1000 is designed to accommodate DIN mount sockets. Made of durable extruded aluminum, the BNDN1000 measures 0.413 (10.5mm) in height and 1.37 (35mm) in width (DIN standard). Standard length is 39" (1,000mm).
DIN Rail End Stop		DIN rail	BNL5	9.1 mm wide.
Replacement Hold-Down Spring Anchor		DIN mount sockets and hold down springs.	Y778-011	For use on DIN rail mount socket when using pullover wire hold down spring. 2 pieces included with each socket.

Switches & Pilot Lights

Signaling Lights

Relays & Sockets

Timers

Contactors

Terminal Blocks

Circuit Breakers

Specifications

Contact Material	Silver cadmium oxide		
Contact Resistance ¹	50mΩ maximum		
Minimum Applicable Load	24V DC, 30 mA; 5V DC, 100 mA (reference value)		
Operating Time ²	SPDT DPDT	20ms maximum	
	3PDT 4PDT	25ms maximum	
Release Time ²	SPDT DPDT	20ms maximum	
	3PDT 4PDT	25ms maximum	
Power Consumption (approx.)	SPDT	AC: 1.1VA (50Hz), 1VA (60Hz)	DC: 0.8W
	DPDT	AC: 1.4VA (50Hz), 1.2VA (60Hz)	DC: 0.9W
	3PDT	AC: 2VA (50Hz), 1.7VA (60Hz)	DC: 1.5W
	4PDT	AC: 2.5VA (50Hz), 2VA (60Hz)	DC: 1.5W
Insulation Resistance	100MΩ minimum (500V DC megger)		
Dielectric Strength ³	SPDT	Between live and dead parts: 2,000V AC, 1 minute	Between contact and coil: 2,000V AC, 1 minute
	DPDT 3PDT 4PDT	Between live and dead parts: 2,000V AC, 1 minute	Between contacts of the same pole: 1,000V AC, 1 minute
Operating Frequency	Electrical:	1,800 operations/hour maximum	
	Mechanical:	18,000 operations/hour maximum	
Vibration Resistance	Damage limits:	10 to 55Hz, amplitude 0.5 mm	
	Operating extremes:	10 to 55Hz, amplitude 0.5 mm	
Shock Resistance	Damage limits:	1,000m/s ² (100G)	
	Operating extremes:	200m/s ² (20G - SPDT, DPDT) 100m/s ² (10G - 3PDT, 4PDT)	
Mechanical Life	50,000,000 operations minimum		
Electrical Life	DPDT	500,000 operations minimum (120V AC, 10A)	
	SPDT 3PDT 4PDT	200,000 operations minimum (120V AC, 10A)	
Operating Temperature ⁴	SPDT DPDT 3PDT 4PDT	-25 to +70°C (no freezing)	
	Operating Humidity	45 to 85% RH (no condensation)	
Weight (approx.)	SPDT: 24g, DPDT: 37g, 3PDT: 50g, 4PDT: 74g		



Note: Above values are initial values.

1. Measured using 5V DC, 1A voltage drop method
2. Measured at the rated voltage (at 20°C), excluding contact bouncing
Release time of relays with diode: 40 ms maximum
3. Relays with indicator or diode: 1000V AC, 1 minute
4. For use under different temperature conditions, refer to Continuous Load Current vs. Operating Temperature Curve. The operating temperature range of relays with indicator or diode is -25 to +40°C.

Characteristics (Reference Data)

Electrical Life Curves

AC Load

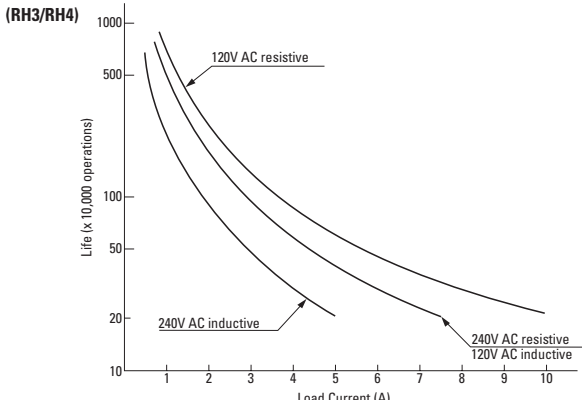
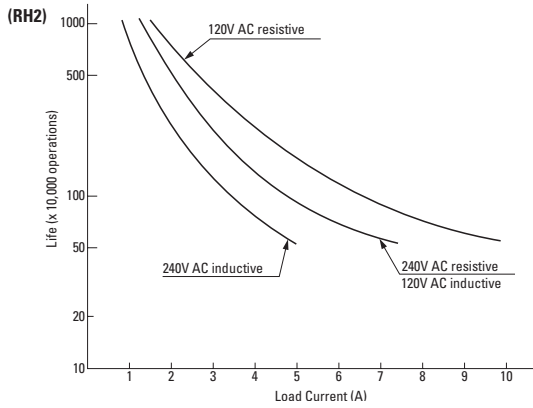
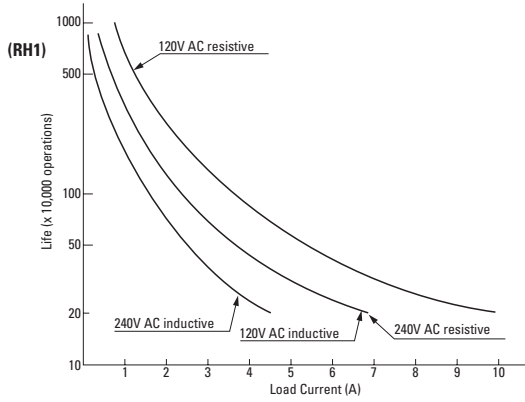

DC Load

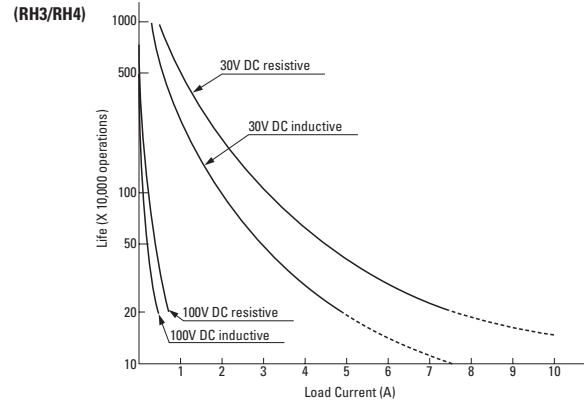
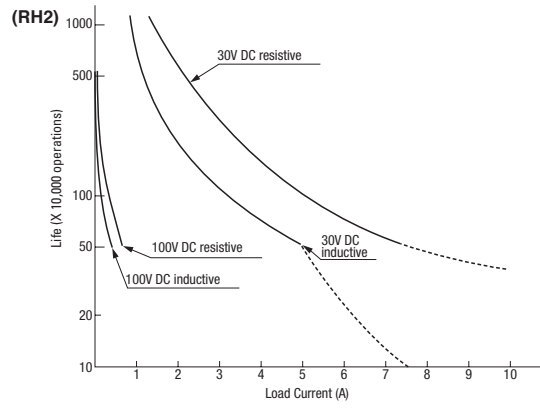
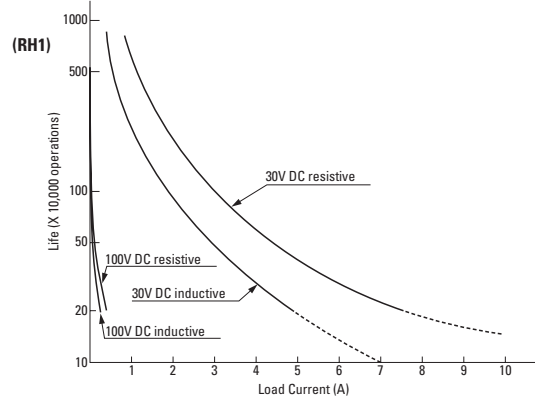

Maximum Switching Capacity

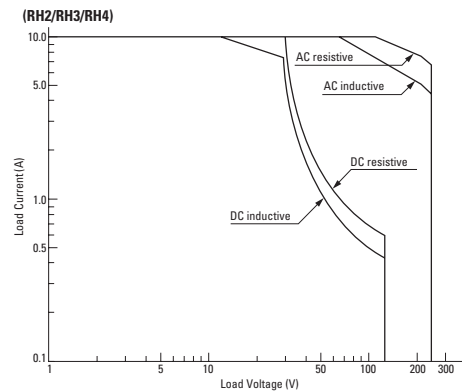
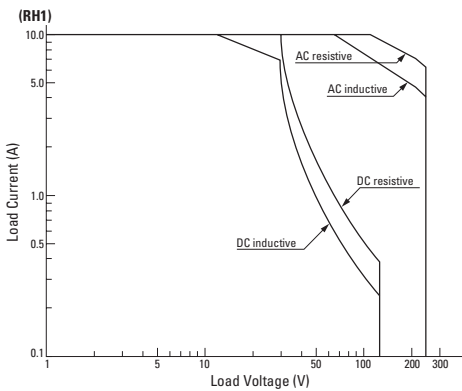

Switches & Pilot Lights

Signaling Lights

Relays & Sockets

Timers

Contactors

Terminal Blocks

Circuit Breakers

Continuous Load Current vs. Operating Temperature Curve (Basic Type, With Check Button, and Top Bracket Mounting Type)

(RH1)

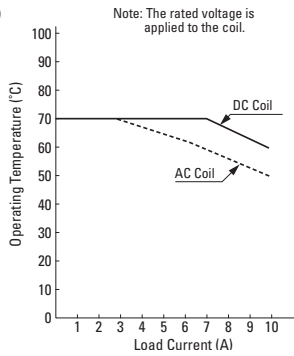

(RH2)

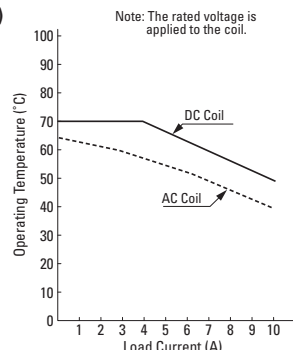

(RH3/RH4)

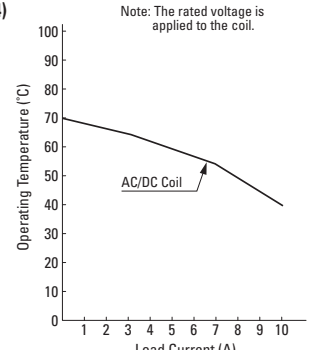

Internal Connection (View from Bottom)

Basic Type

SPDT

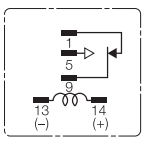

DPDT

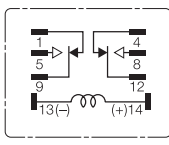

3PDT

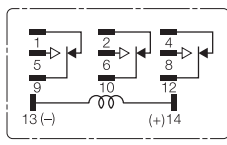

4PDT

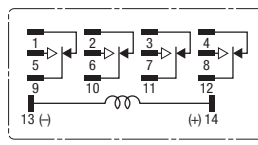

With Check Button

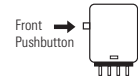

Contacts can be operated by pressing the check button.

With Indicator (-L type)

SPDT

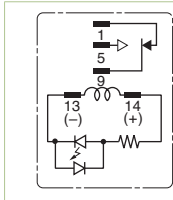

Below 100V AC/DC

3PDT

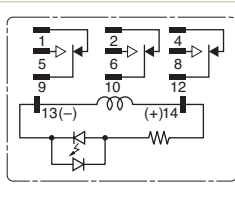

Below 24V AC/DC

4PDT

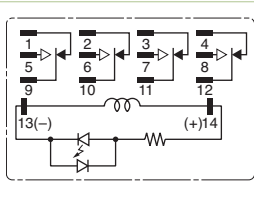

24V AC/DC and over

DPDT

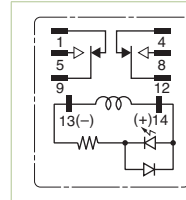

100V AC/DC and over

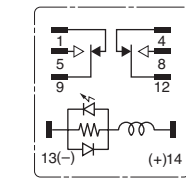
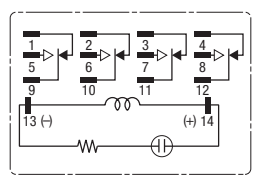
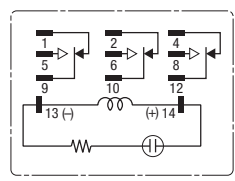
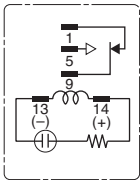

When the relay is energized, the indicator goes on.

- Relay coils less than 100V DC do not contain a protection diode (except DPDT).
- Relay coils below 100V use LED indicator, coils above 100V use neon lamp indicator.
- LED color of DPDT model is green

With Diode (-D type)

SPDT

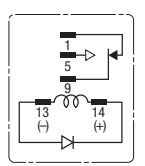

DPDT

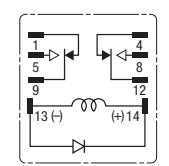

3PDT

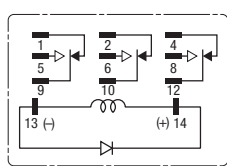

4PDT

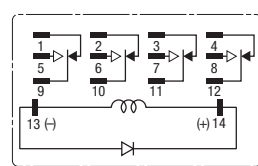

Contains a diode to absorb the back emf generated when the coil is de-energized. The release time is slightly longer. Available for DC coil only.

- Diode Characteristics
Reverse withstand voltage: 1,000V
Forward current: 1A

With Indicator LED & Diode (-LD type)

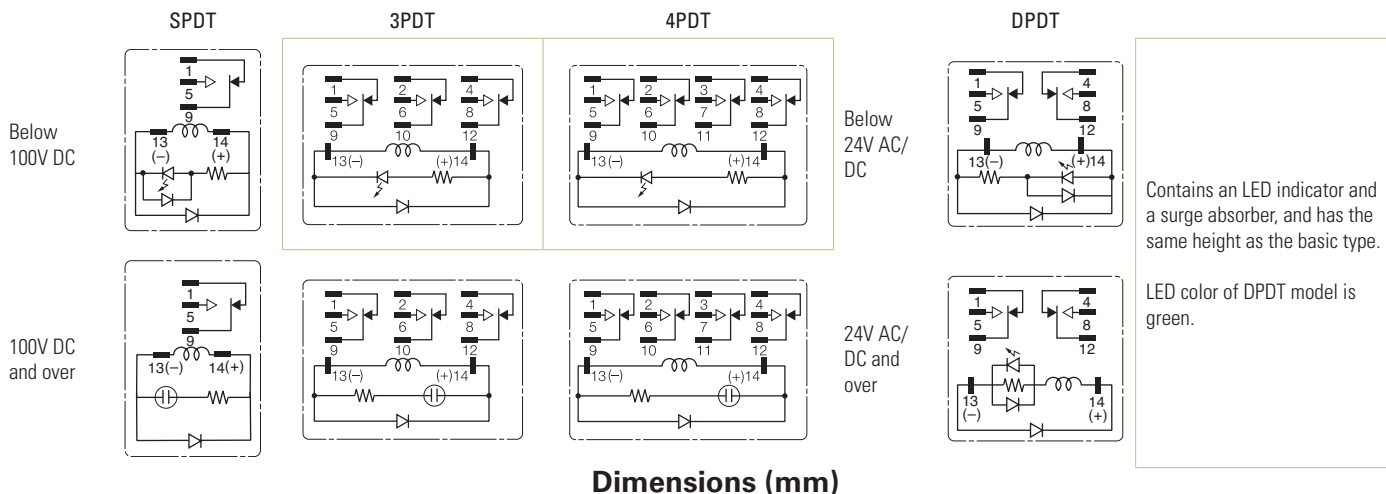

Dimensions (mm)

RH1B-U/RH1B-UL/RH1B-UD/RH1B-ULD

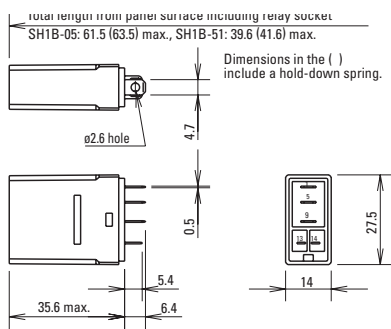

RH2B-U/RH2B-UL/RH2B-UD/RH2B-ULD

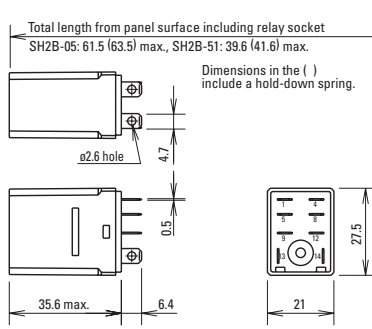

RH3B-U/RH3B-UL/RH3B-UD/RH3B-ULD

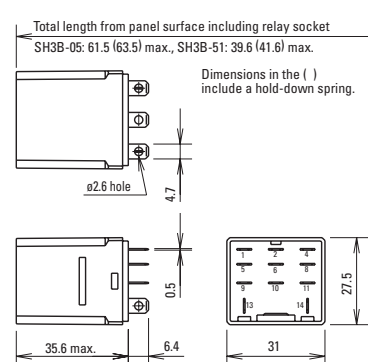

RH4B-U/RH4B-UL/RH4B-UD/RH4B-ULD

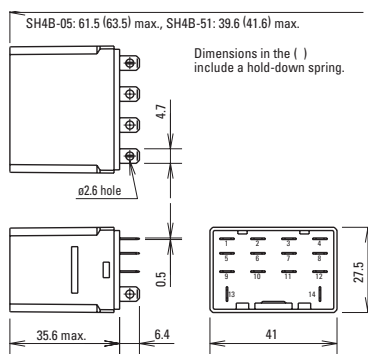

RH1B-UT

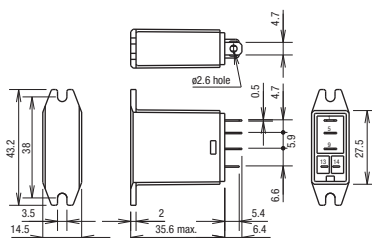

RH2B-UT

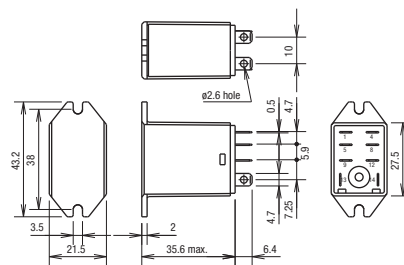

RH3B-UT

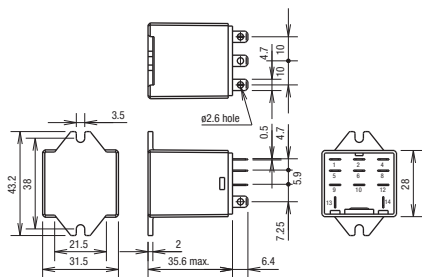

RH4B-UT

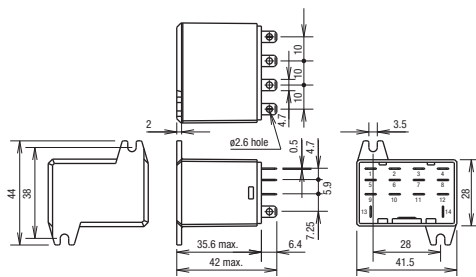

Switches & Pilot Lights

Signaling Lights

Relays & Sockets

Timers

Contactors

Terminal Blocks

Circuit Breakers

Dimensions con't (mm)

RH1V2-U/RH1V2-UD

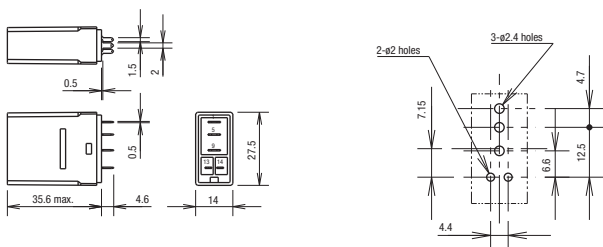

RH2V2-U/RH2V2-UL/RH2V2-UD

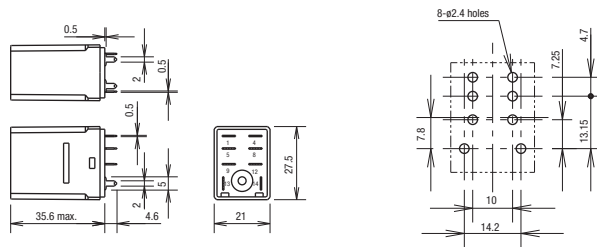

RH3V2-U/RH3V2-UL/RH3V2-D

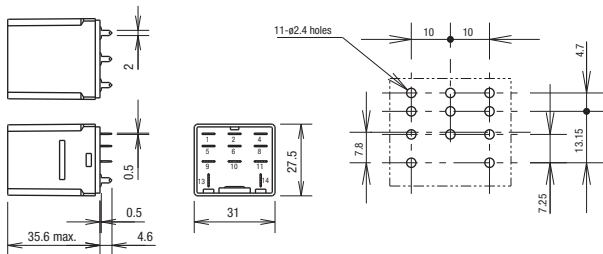

RH4V2-U/RH4V2-UL/RH4V2-UD

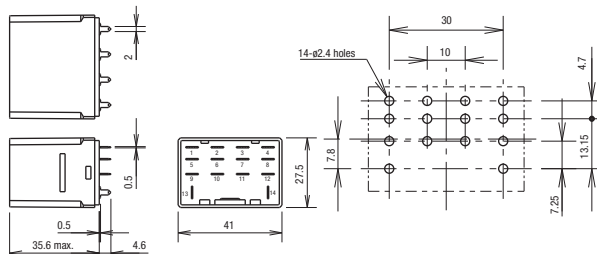

Standard DIN Rail Mount Sockets

SH1B-05

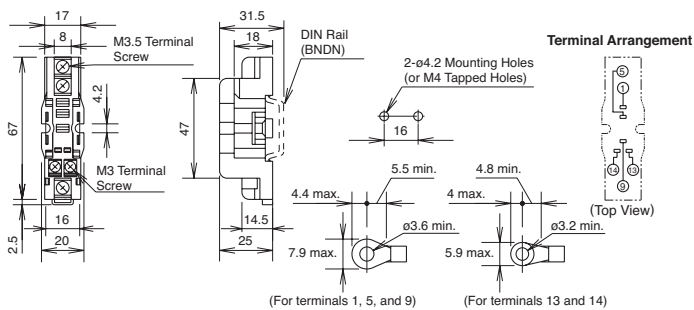

SH2B-05

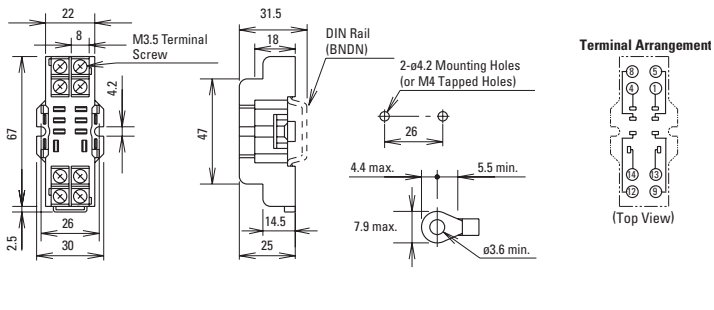

SH3B-05

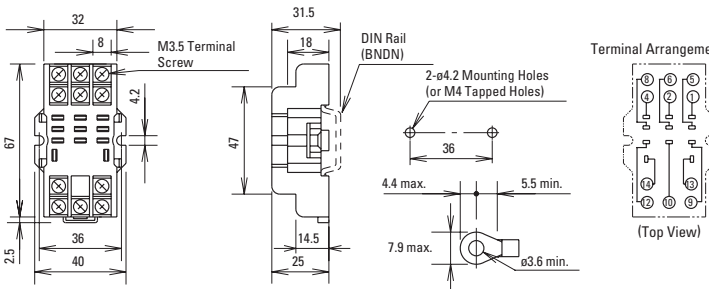

SH4B-05

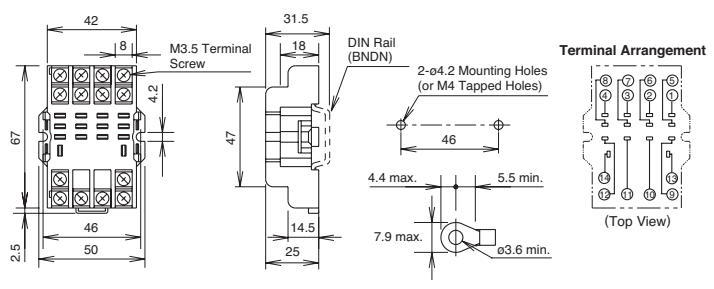

Switches & Pilot Lights

Signaling Lights

Relays & Sockets

Timers

Contactors

Terminal Blocks

Circuit Breakers

Dimensions con't (mm)

Finger-safe DIN Rail Mount Sockets

SH1B-05C

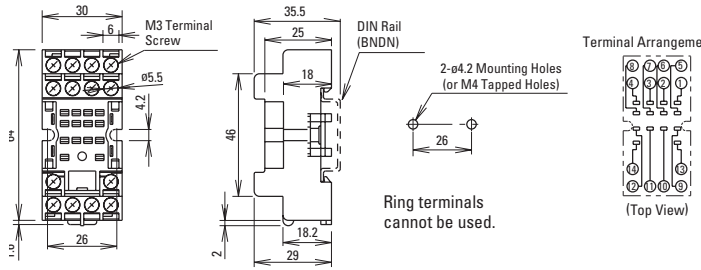

SH2B-05C

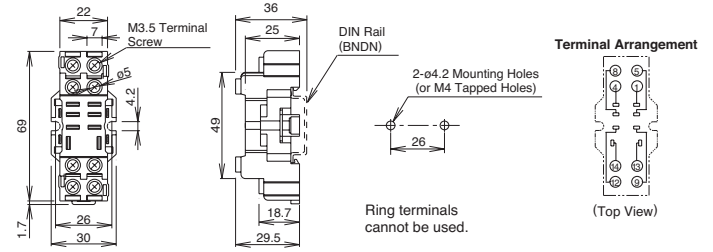

SH3B-05C

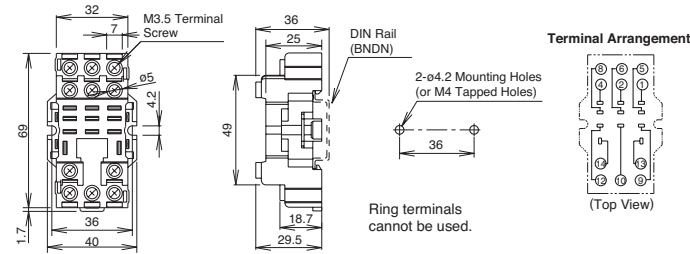

SH4B-05C

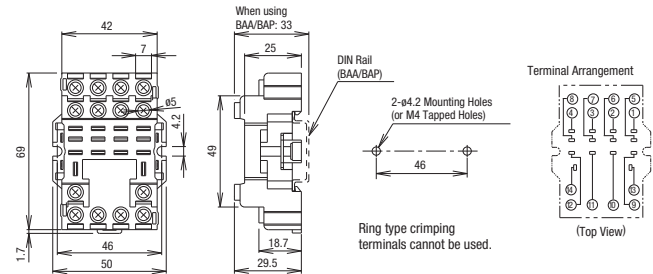

Through Panel Mount Socket

SH1B-51

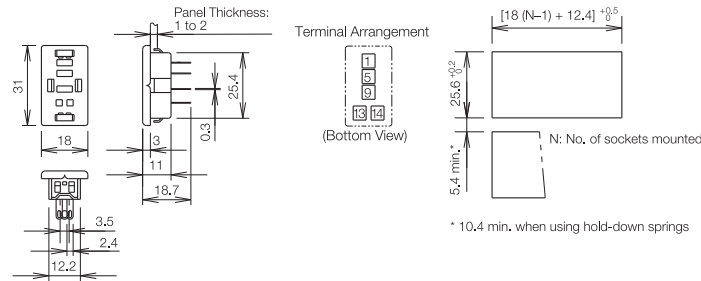

SH2B-51

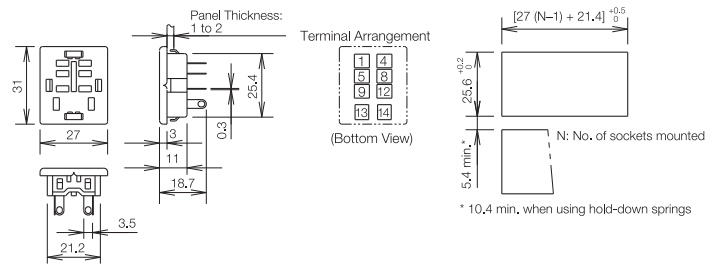

SH3B-51

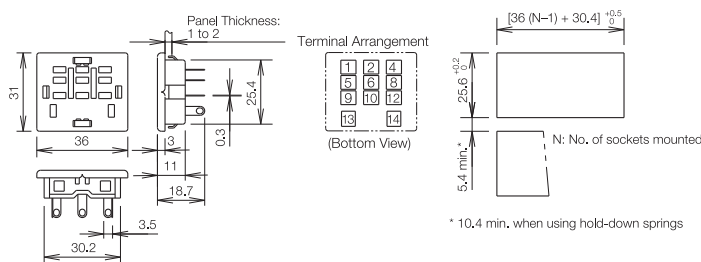

SH4B-51

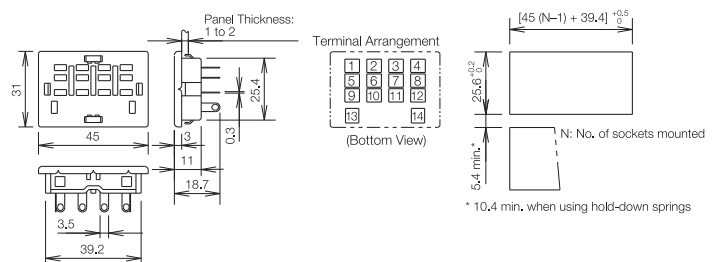

Switches & Pilot Lights
Signaling Lights

Relays & Sockets

Timers

Contactors

Terminal Blocks

Circuit Breakers

Dimensions con't (mm)

PCB Mount Sockets

SH1B-62

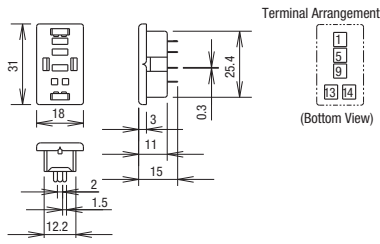

SH2B-62

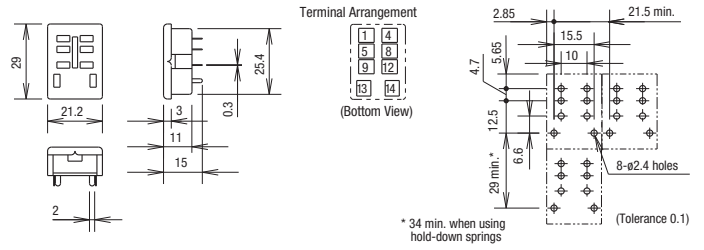

SH3B-62

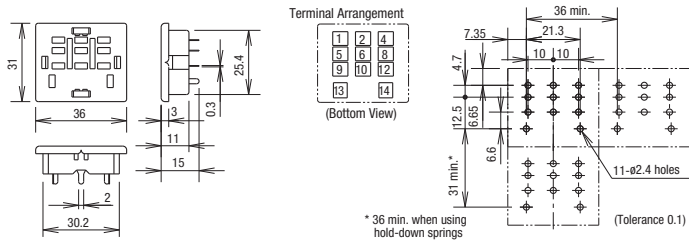

SH4B-62

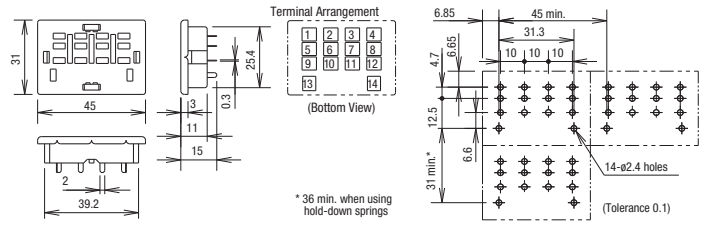

Switches & Pilot Lights

Signalng Lights

Relays & Sockets

Timers

Contactors

Terminal Blocks

Circuit Breakers