

Super Manual Fiber Amplifier

E3X-NA

Adjuster type standard that is the culmination of true ease and simplicity



Features

Self-explanatory LED bar displays of light levels

The previous manual type used the stability and incident level indicators to display the light level change, which was difficult to understand at a glance. The E3X-NA uses the LED bars to display the light level, ensuring the light level change at a glance.

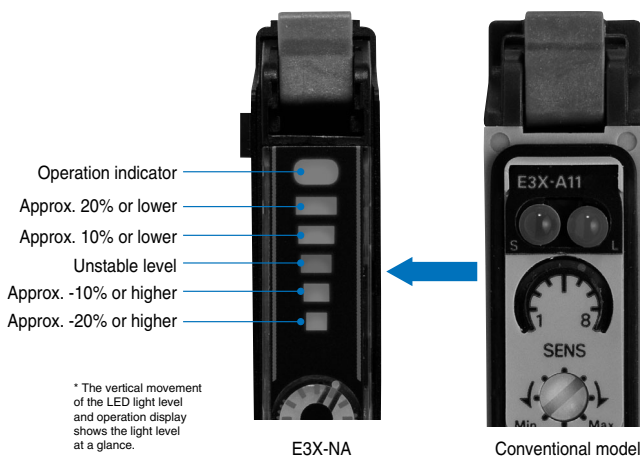

Same "Wire-saving" Connector as E3X-DA-N

OMRON's original wiring-saving connector, which was inherited from the digital fiber amplifier E3X-DA-N, allows connection of up to 16 units.

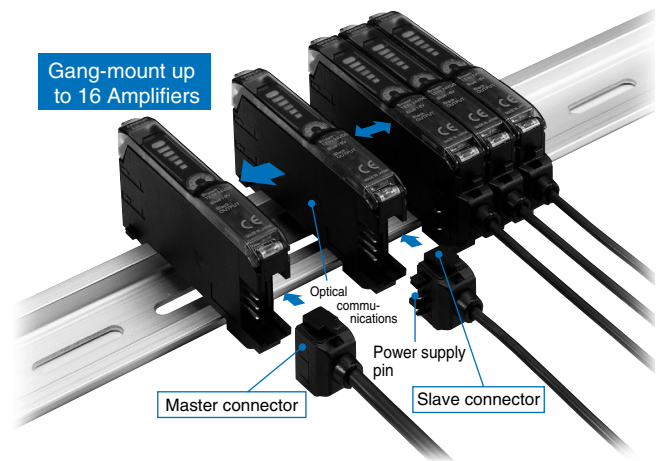

Features

Reduced wiring and space requirements for power lines

Example for 5 Amplifiers E3X-NA Series

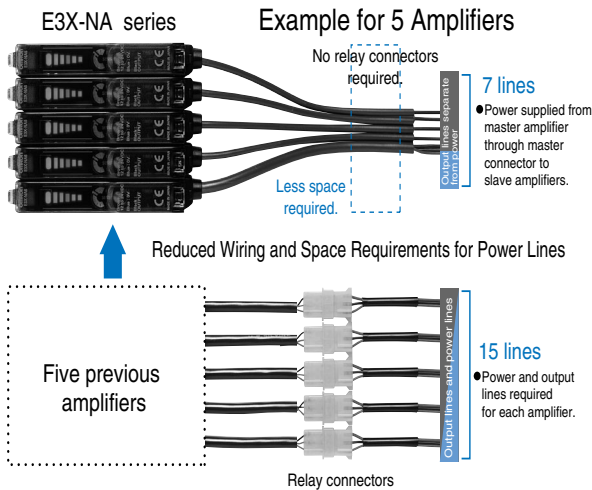

Optical Communications to Prevent Mutual Interference

Optical communication between amplifiers prevents mutual interference. Up to 5 fiber heads can be installed closely, except E3X-NA□F.

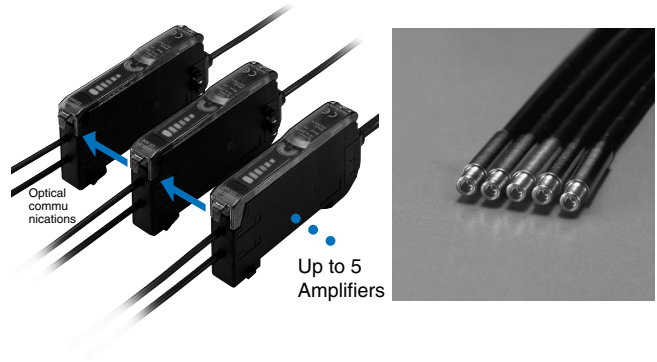

Same Sensing Distance as Previous Long-distance Models

200 mm Reflective Models

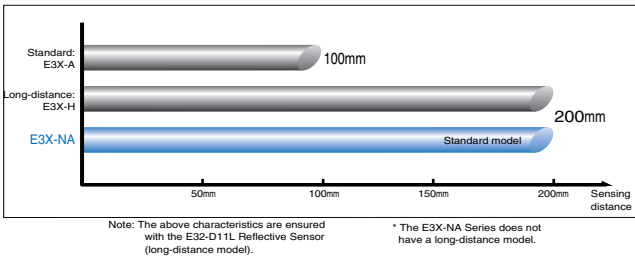

Approximately Seven Times the Detection Accuracy

Applied Fiber: E32-T16P (screen fiber) set at 100 mm. E3X-A1 1 (previous model) Minimum detection object: 2.0 mm dia. E3X-NA 0.3 mm dia.

Applied Fiber: E32-T16 (screen fiber) set at 100 mm.

Minimum detection object: E3X-A11 (previous model) **2.0 mm dia.** → **0.3 mm dia.** (7 times improvement)

Addition of high-speed type and waterproof type to the series

Dimensions and Designs Inherited from the E3X-DA-N Digital Fiber Amplifier

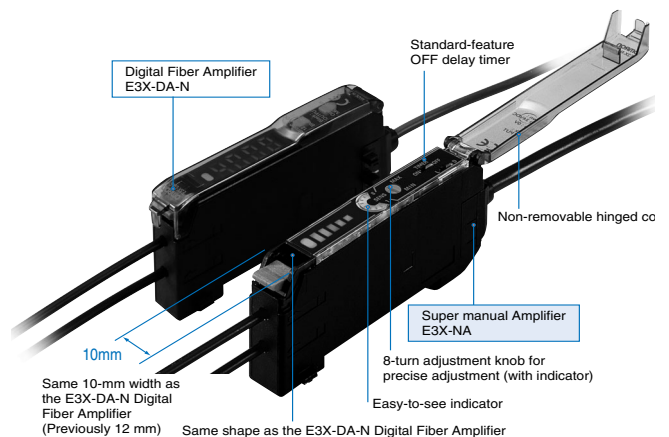



Ordering Information

Amplifier Units

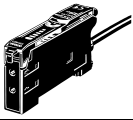
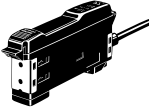

Pre-wired

| Item | Shape | Control output | Model | |
|------------------------|---|----------------|------------|------------|
| | | | NPN output | PNP output |
| Standard models |  | ON/OFF output | E3X-NA11 | E3X-NA41 |
| High-speed detection | | | E3X-NA11F | E3X-NA41F |
| Mark-detecting models | | | E3X-NAG11 | E3X-NAG41 |
| Water-resistant models |  | | E3X-NA11V | E3X-NA41V |

Connector type

| Item | Shape | Applicable Connector (order separately) | | Control output | Model | |
|---------------------------------------|---|---|-------------------|----------------|------------|------------|
| | | Master | Slave | | NPN output | PNP output |
| Standard models |  | Master E3X-CN11 | Slave E3X-CN12 | ON/OFF output | E3X-NA6 | E3X-NA8 |
| Water-resistant models (M8 Connector) |  | XS3F-M421-40□-A XS3F-M422-40□-A | | | E3X-NA14V | E3X-NA44V |

Amplifier Units Connectors (Order Separately) Note: Stickers for Connectors are included as accessories.



| Item | Shape | Cable length | No. of conductors | Model |
|------------------|---|--------------|-------------------|----------|
| Master connector |  | 2 m | 3 | E3X-CN11 |
| Slave connector |  | | 1 | E3X-CN12 |

Precautions for ordering the connector type
Refer to the following tables when placing an order. Basically, Amplifier Units and connectors are sold separately.
Please place an order after referring to the combination given below.

| Amplifier Units | | | Applicable Connector (order separately) | |
|-----------------|---------|---------|---|-------------------|
| Type | NPN | PNP | Master connector | Slave connector |
| Standard | E3X-NA6 | E3X-NA8 | E3X-CN11 (3 wires) | E3X-CN12 (1 wire) |

When Using 5 Amplifier Units
Amplifier Units (5 Units) + 1 Master Connector + 4 Slave Connectors



Sensor I/O Connectors (Order separately)

| Size | Cable type | Shape | Cable length | Model | |
|------|----------------|--|--------------|--------------|-----------------|
| M8 | Standard cable | Straight  | 2 m | 4 conductors | XS3F-M421-402-A |
| | | | 5 m | | XS3F-M421-405-A |
| | | L-shaped  | 2 m | | XS3F-M422-402-A |
| | | | 5 m | | XS3F-M422-405-A |

Note: Refer to page NB-6 for details.

Accessories (Order Separately)

Mounting Brackets

| Shape | Applicable type | Model | Quantity |
|---|---------------------------------|----------|----------|
|  | E3X-NA□ E3X-NA□F E3X-NAG□ | E39-L143 | 1 |
|  | E3X-NA□V | E39-L148 | |

End Plate

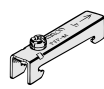
| Shape | Model | Quantity |
|--|-------|----------|
|  | PFP-M | 1 |

Rating/performance

Amplifier Units

| Item | Model | Type | Pre-wired | | | | Connector type | |
|-------------------------------|---|---|--|---|---|---|-----------------|--|
| | | | Standard models | High-speed de- tection models | Mark-detecting models | Water-resistant models | Standard models | Water-resistant mod- els (M8 Connector) |
| | | | NPN output | E3X-NA11 | E3X-NA11F | E3X-NAG11 | E3X-NA11V | E3X-NA6 |
| | PNP output | E3X-NA41 | E3X-NA41F | E3X-NAG41 | E3X-NA41V | E3X-NA8 | E3X-NA44V | |
| Light source (wave length) | Red LED (680 nm) | | Green LED (520 nm) | Red LED (680 nm) | | | | |
| Power supply volt- age | 12 to 24 VDC ±10%, ripple (p-p): 10% max. | | | | | | | |
| Current consumption | 35 mA max. | 35 mA max. (at power supply voltage 24 VDC) | 35 mA max. | | | | | |
| Control output | Load current 50 mA (residual voltage 1 V max. each) Open collector output type (depends on the NPN/PNP out- put format) Light-ON/Dark-ON switch selectable | | | | | | | |
| Response time | Operation or re- set: 200 s max. * | Operating: 20 s max. Reset: 30 s max. | 200 s max. for operation and reset respectively (See note.) | | | | | |
| Sensitivity adjust- ment | 8-turn endless adjuster (with indicator) | | | | | | | |
| Protective circuits | Reverse polarity protection, out- put short-circuit protection, mutu- al interference prevention (opti- cally synchro- nized) | Reverse polarity protection, out- put short-circuit protection | Reverse polarity protection, output short-circuit protection, mutual interfer- ence prevention (optically synchronized) | | | | | |
| Timer function | OFF-delay timer: 40 ms (fixed) | | | | | | | |
| Ambient illuminance | Incandescent lamp: 10,000 lux max. Sunlight: 20,000 lux max. | | | | | | | |
| Ambient temperature | Operating: Groups of 1 to 3 Amplifiers: -25 to +55°C, Groups of 4 to 11 Amplifiers: -25 to +50°C, Groups of 12 to 16 Amplifiers: -25 to +45°C Storage: -30 to +70°C (with no icing and condensation) | | | | | | | |
| Ambient humidity | Operating/Storage: 35% to 85% RH (with no condensation) | | | | | | | |
| Insulation resistance | 20 M min. at 500 VDC | | | | | | | |
| Dielectric strength | 1,000 VAC at 50/60 Hz for 1 minute | | | | | 500 VAC at 50/60 Hz for 1 minute | | |
| Vibration resistance | 10 to 55 Hz with a 1.5 mm double amplitude for 2 hrs each in X, Y and Z directions | | | | | | | |
| Shock resistance | Destruction: 500 m/s ² for 3 times each in X, Y, and Z directions | | | | | | | |
| Protective structure | IEC 60529 IP50 (with Protective Cover attached) | | | IEC 60529 IP66 (with Protective Cover attached) | IEC 60529 IP50 (with Protective Cover attached) | IEC 60529 IP66 (with Protective Cover attached) | | |
| Connection method | Pre-wired models (standard length: 2 m) | | | | Connector type | M8 connector | | |
| Weight (Packed state) | Approx. 100 g | | | Approx. 110 g | Approx. 55 g | 65 g | | |
| Material | Case | PBT (polybutylene terephthalate) | | | | | | |
| | Cover | Polycarbonate | | Polyethersul- fone (PES) | Polycarbonate | Polyethersul- fone (PES) | | |
| Accessories | Instruction manual | | | | | | | |

* If 8 or more Units are installed side-by-side, the response time will be 350 s max.

Amplifier Unit Connectors

| Item | Model | E3X-CN11 | E3X-CN12 |
|-----------------------|----------|--|--------------|
| Rated current | | 2.5 A | |
| Rated voltage | | 50 V | |
| Contact resistance | | 20 mΩ max. (20 mVDC max., 100 mA max.) [By connection with amplifier unit and connection with adjacent connector (except conductor resistance of cable)] | |
| No. of insertions | | 50 times (By connection with amplifier unit and connection with adjacent connector) | |
| Material | Housing | PBT (polybutylene terephthalate) | |
| | Contacts | Phosphor bronze/gold-plated nickel | |
| Weight (Packed state) | | Approx. 55 g | Approx. 25 g |

Characteristic data (typical)

Number of Turns of Sensitivity Adjuster vs. Sensing Distance

E32-T11L

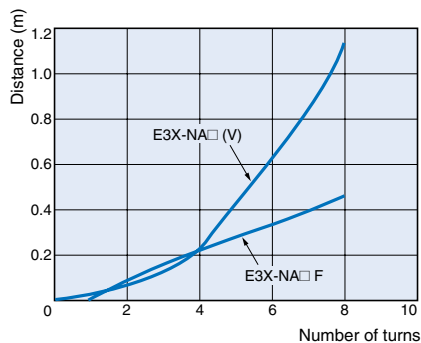

E32-D11L

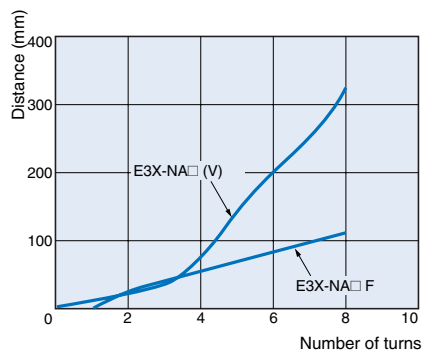

Sensing Distance vs. Hysteresis

E32-T11L

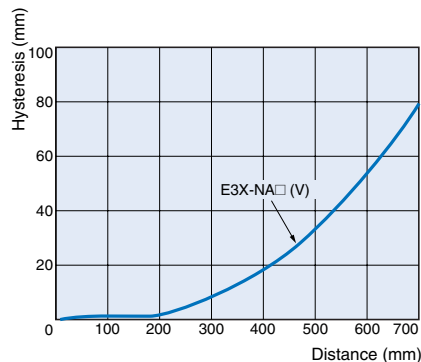

E32-D11L

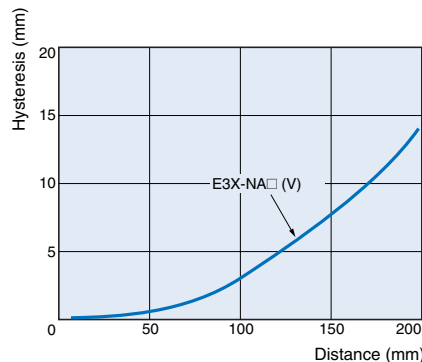

Output Circuit Diagram

NPN output

| Model | Operating status of output transistor | Timing chart | Mode selection switch | Output circuit |
|---|---------------------------------------|--------------|-----------------------|---|
| E3X-NA11 E3X-NA6 E3X-NAG11 E3X-NA11F E3X-NA11V E3X-NA14V | Light ON | | L ON (LIGHT ON) | <p>M8 Connector Pin Arrangement</p> <p>Note: Pin 2 is open.</p> |
| | Dark ON | | D ON (DARK ON) | |

PNP output

| Model | Operating status of output transistor | Timing chart | Mode selection switch | Output circuit |
|---|---------------------------------------|--------------|-----------------------|---|
| E3X-NA41 E3X-NA8 E3X-NAG41 E3X-NA41F E3X-NA41V E3X-NA44V | Light ON | | L ON (LIGHT ON) | <p>M8 Connector Pin Arrangement</p> <p>Note: Pin 2 is open.</p> |
| | Dark ON | | D ON (DARK ON) | |

Connectors (Sensor I/O connectors)

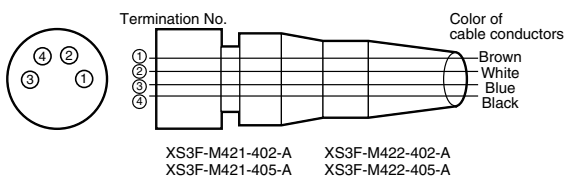

| Class | Wire, outer jacket color | Connector pin No. | Application |
|--------|--------------------------|-------------------|--------------------|
| For DC | Brown | ① | Power supply (+V) |
| | White | ② | - |
| | Blue | ③ | Power supply (0 V) |
| | Black | ④ | Output |

Note: Pin 2 is not used.

Nomenclature:

Amplifier Units

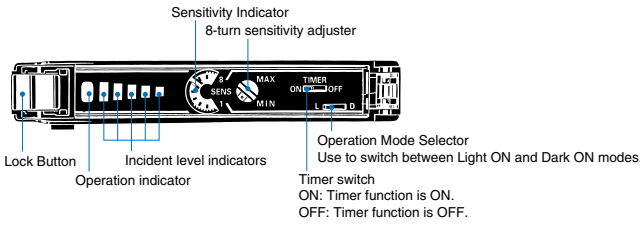

Operation

Indicator status

In addition to the operation indicator (orange), E3X-NA has indicators that denotes the incident level (4 green and 1 red indicators). Use them for optical axis adjustment and maintenance.

| Indicator status (L/ON) | Operation indicator (L/ON) | Incident level |
|-------------------------------|----------------------------|---|
| <p>Not lit Lit (See note)</p> | Not lit | Approx. 80% to 90% of operating level |
| | Not lit | Approx. 80% to 90% of operating level |
| | Not lit or lit | Approx. 90% to 110% of operating level |
| | Lit | Approx. 110% to 120% of operating level |
| | Lit | Approx. 120% min. of operating level |

Note: The rightmost indicator is turned ON at the "0 incident level".

Precautions

Correct Use

Amplifier Units

Design

Communications Hole

The window provided in the side face of the unit is a communication window for prevention of mutual interference when it is connected with the other unit. Note that the optional Mobile Console E3X-MC11 cannot be used. When the incident level of the sensor is excessive, mutual interference prevention may not be activated. At that time, make adjustment with the sensitivity adjuster. When the unit is used with the E3X-DA-N series, mutual interference prevention is not activated.

Mounting

Connection/removing of amplifier units

(Connection)

1. Install the Amplifier Units one at a time onto the DIN track.

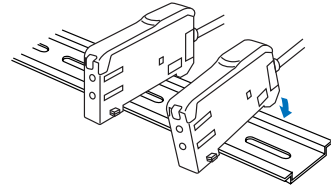

2. Slide the Amplifier Units together, line up the clips, and press the Amplifier Units together until they click into place.

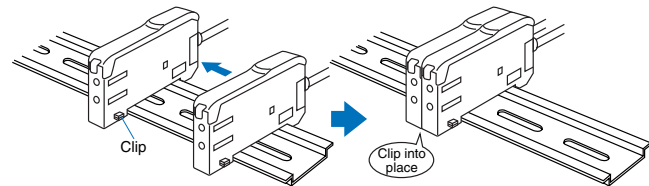

(Removing)

Slide one unit away from the other and remove them one by one. (Do not remove the connected units together from the DIN rail.)

Note: 1. When the amplifier units are interconnected, the operating ambient temperature changes depending on the number of connected amplifier units. Check "Ratings/Performance".
2. Before connecting or removing the units, always switch power off.

Operating Environment

Ambient Conditions

Always remove dust, dirt, etc. from the optical communication window, which may disable communication.

Miscellaneous

Protective Cover

Be sure to set the Protective Cover before use.

Amplifier Unit Connectors

Installation

Installation Connectors

1. Insert the Master or Slave Connector into the Amplifier Unit until it clicks into place.

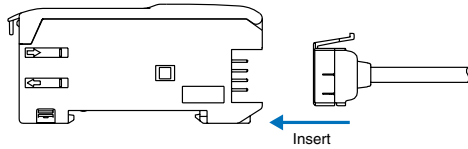

2. Join Amplifier Units together as required after all the Master and Slave Connectors have been inserted.
3. Apply the supplied seal to the non-connection surface of the master/slave connector.

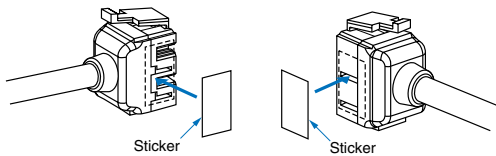

Note: Apply the seal to the grooved side.

Removing Connectors

1. Slide the slave Amplifier Unit for which the Connector is to be removed away from the rest of the group.
2. After the Amplifier Unit has been separated, press down on the lever on the Connector and remove it. (Do not attempt to remove Connectors without separating them from other Amplifier Units first.)

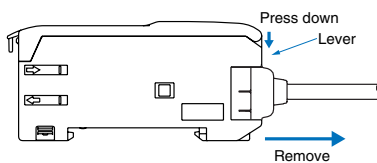

Mounting End Plate (PFP-M)

Depending on the installation type, an Amplifier Unit may move during operation. In this case, use an End Plate. Before installing an End Plate, remove the clip from the master Amplifier Unit using a nipper or similar tool.

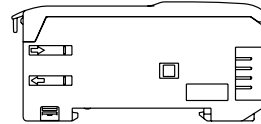

The sensor bottom is also equipped with the clip removing mechanism.

1. Insert the clip to be removed into the slit underneath the clip on another Amplifier Unit.

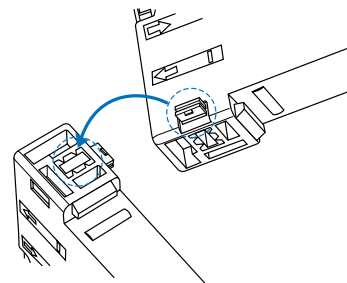

2. Remove the clip by rotating the Amplifier Unit.

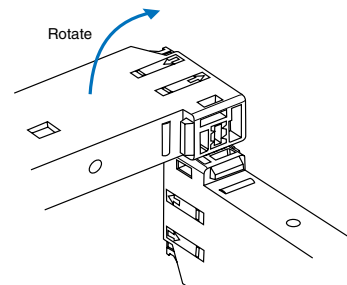

Pull Strengths for Connectors (Including Cables)

E3X-CN11: 30 N max. E3X-CN12: 12 N max.

Dimensions (Unit: mm)

Amplifier Units

Pre-wired

- E3X-NA11
- E3X-NA11F
- E3X-NA41
- E3X-NA41F
- E3X-NAG11
- E3X-NAG41

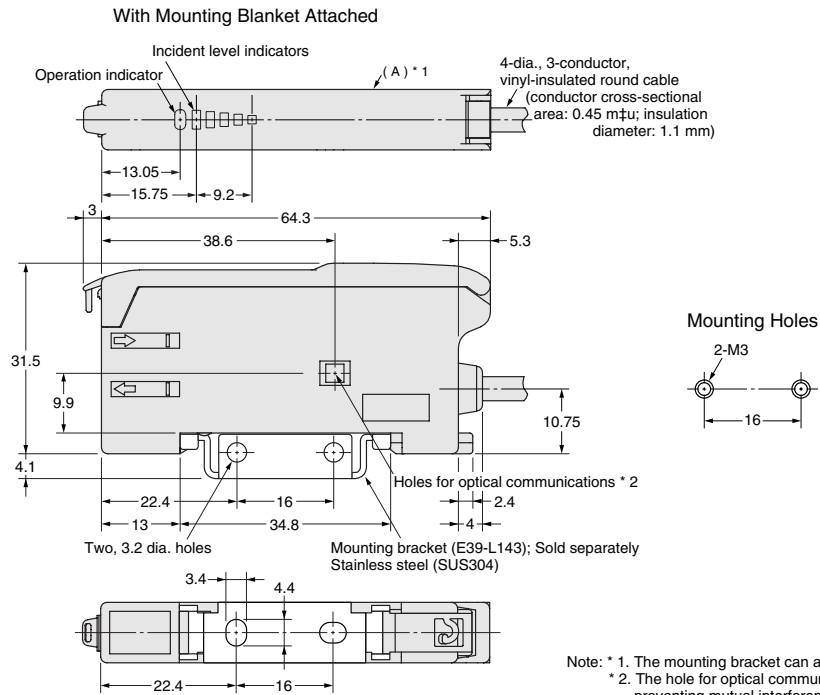
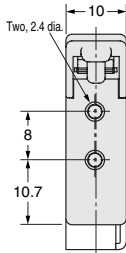
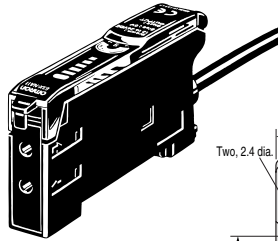

Note: * 1. The mounting bracket can also be used on side A.
 * 2. The hole for optical communications is for preventing mutual interference. There is no hole for E3X-NA□F models.

Amplifier Units with cables,
Water-resistant Models

- E3X-NA11V
- E3X-NA41V

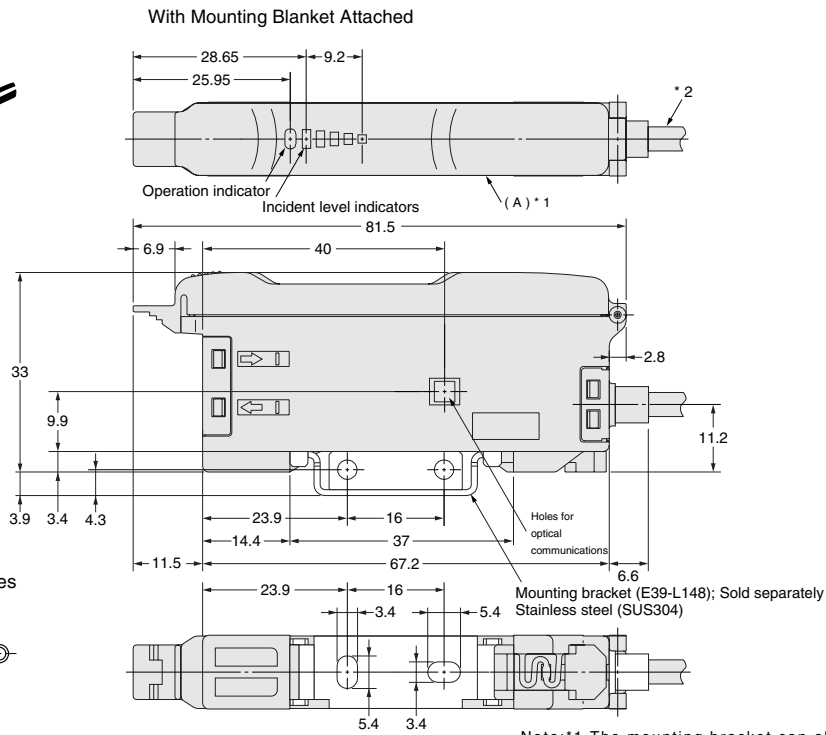
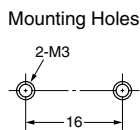
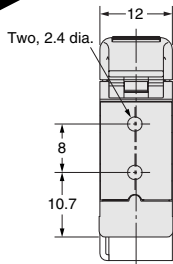
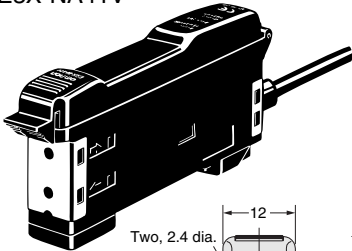

Note: *1. The mounting bracket can also be used on side A.
 *2. 4-dia., 3-conductor, vinyl-insulated round cable (conductor cross-sectional area: 0.45 mm²; insulation diameter: 1.1 mm)

Connector type

E3X-NA6
E3X-NA8

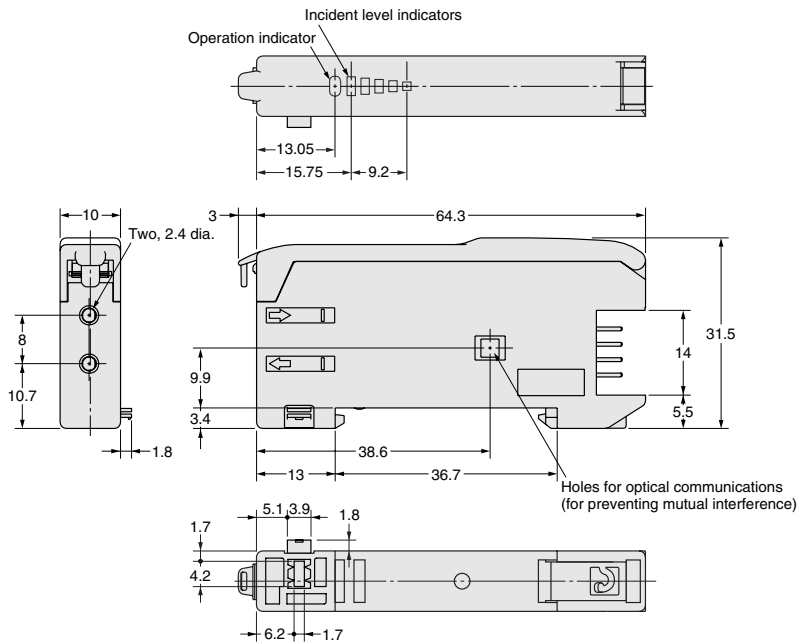
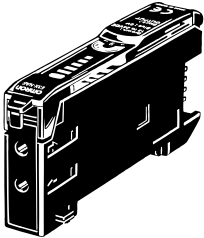

Dimensions with Master Connector Connected

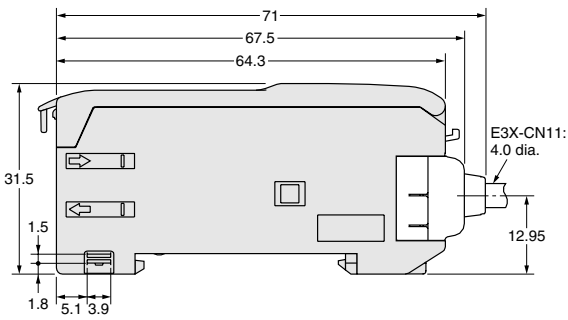

Dimensions with Slave Connector Connected

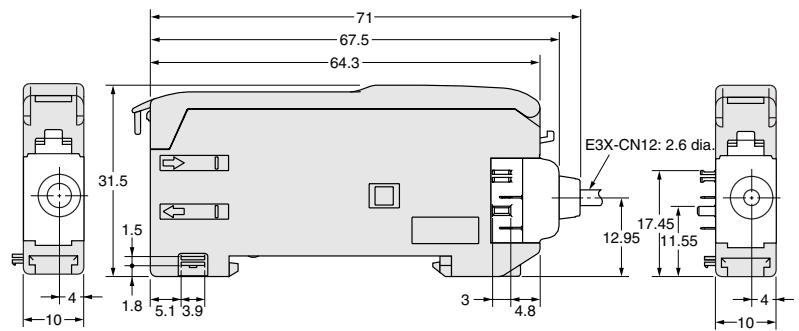

Amplifier Units M8 Connectors,
Water-resistant Models

E3X-NA14V
E3X-NA44V

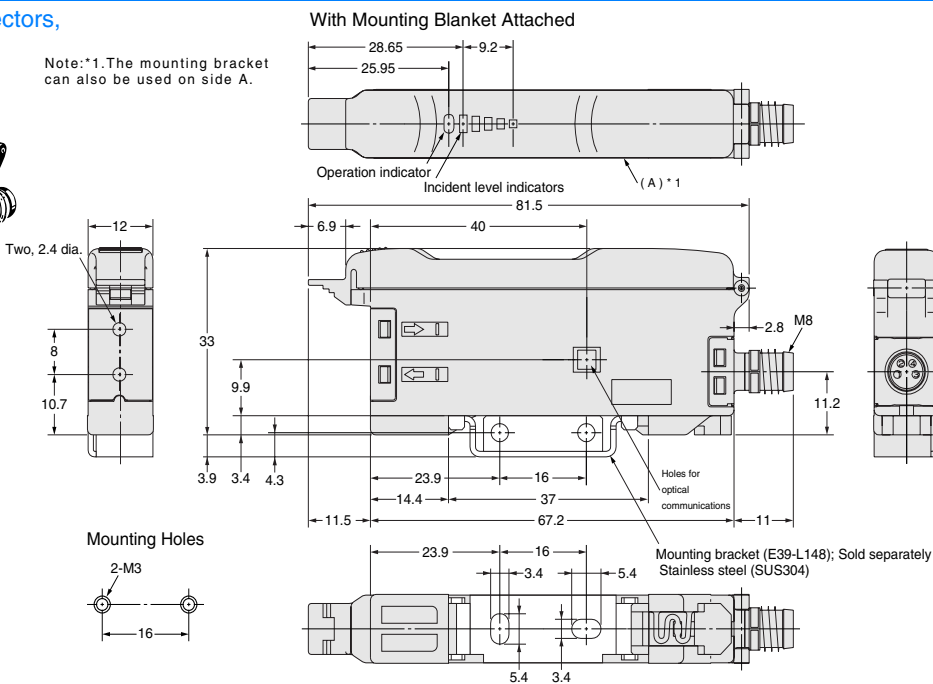

Amplifier Unit Connectors

Master connector

E3X-CN11

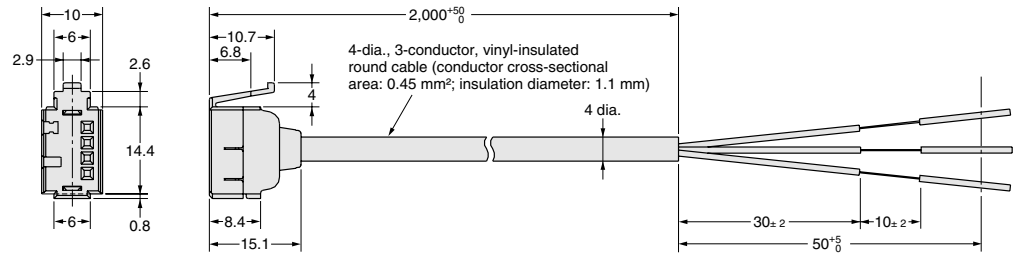
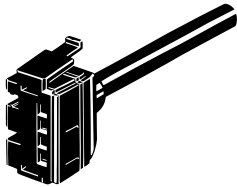

Slave connector

E3X-CN12

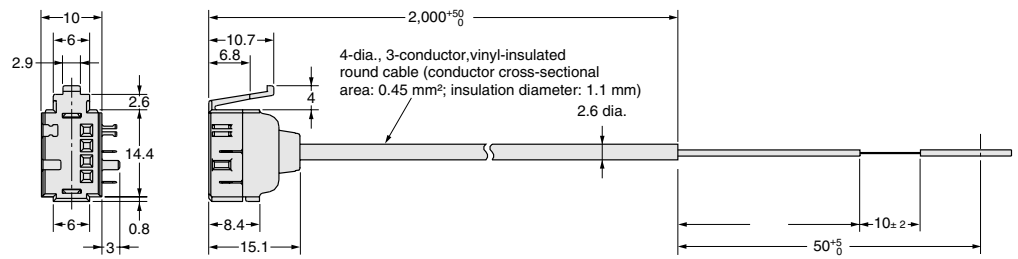
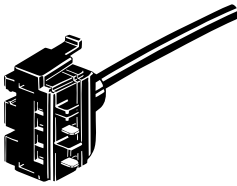

Accessories (Order Separately)

Mounting Brackets

H-5

ALL DIMENSIONS SHOWN ARE IN MILLIMETERS.

To convert millimeters into inches, multiply by 0.03937. To convert grams into ounces, multiply by 0.03527.