



**Customised to your machine**

- High starting torque in open loop: 200% at 0.3 Hz, Full torque at 0 Hz in closed loop
- Sensor-less and vector closed-loop control
- Double rating VT 120%/1 min and CT 150%/1 min
- Built-in EMC filter, logic programming and application functionality
- Positioning functionality
- Automatic energy saving
- Micro-surge voltage suppression
- Communication options: Modbus, DeviceNet, PROFIBUS, CompoNet, EtherCAT and ML2
- Regenerative solutions as option
- CE, cULus, RoHS

**Ratings**

- 200 V class three-phase: 0.4 kW to 55 kW
- 400 V class three-phase: 0.4 kW to 132 kW

**System configuration**

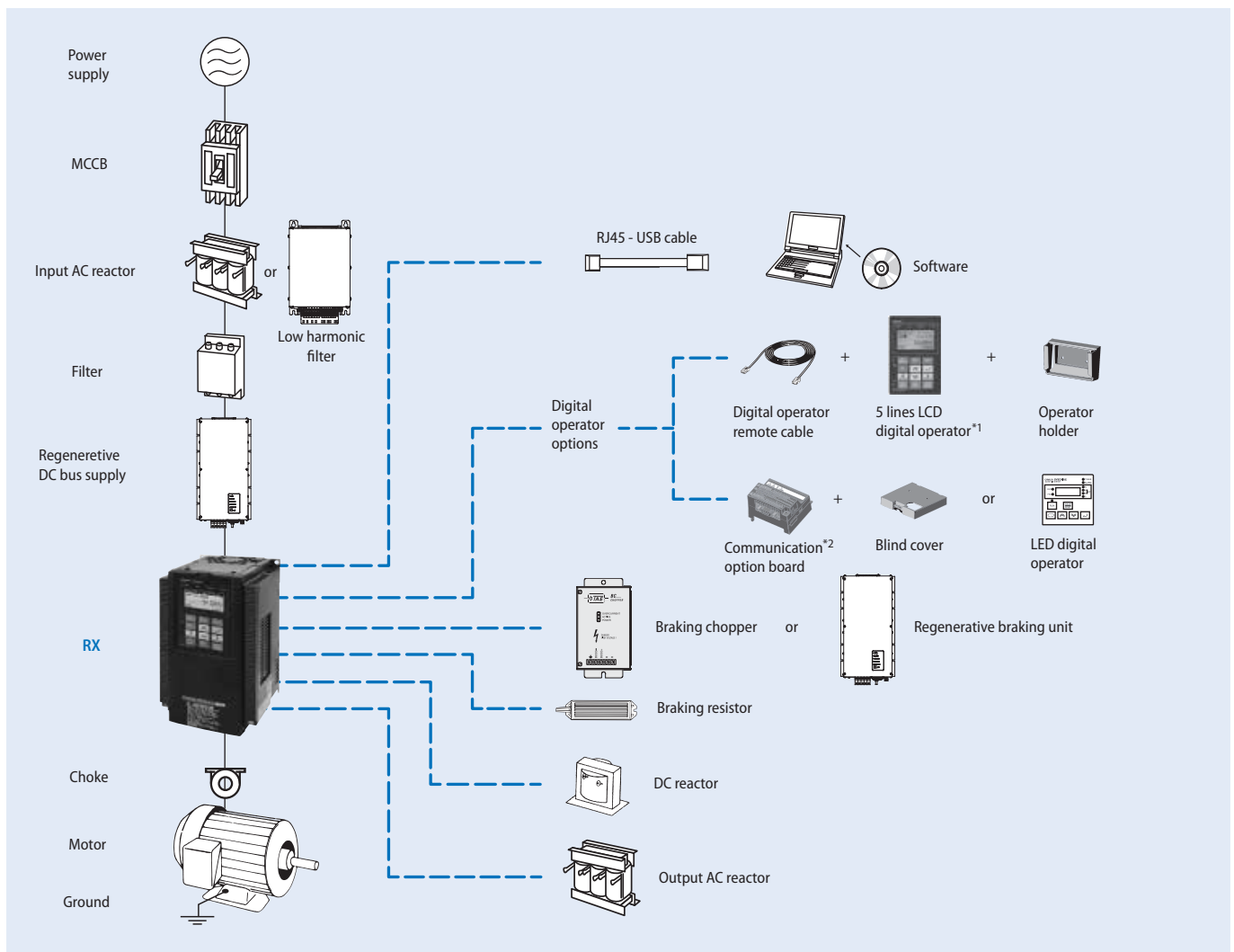

\*1 The 5 lines LCD digital operator is provided with the inverter from factory.

\*2 When a communication option board is mounted, there are two options: mount a blind cover or a LED digital operator.

Type designation

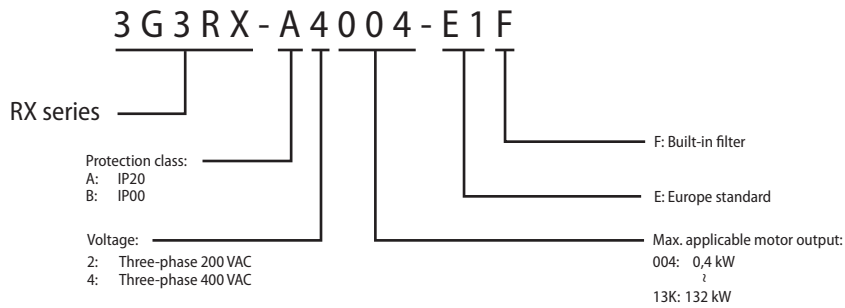

Specifications

Common specifications

Model number: 3G3RX	Specifications	
General functions	Control methods	Phase-to-phase sinusoidal pulse with modulation PWM (Sensorless vector control, close loop vector with motor feedback, V/F)
	Output frequency range	0.10 to 400.00 Hz
	Frequency precision	Digital set value: $\pm 0.01\%$ of the max. frequency
		Analogue set value: $\pm 0.2\%$ of the max. frequency ( $25 \pm 10^\circ\text{C}$ )
	Resolution of frequency set value	Digital set value: 0.01 Hz
		Analog input: 12 bit
	Resolution of output frequency	0.01 Hz
	Starting torque	150%/0.3 Hz (under sensor-less vector control or sensor-less vector control at 0 Hz)
		200%/Torque at 0 Hz (under sensor-less vector control at 0Hz, when a motor size one rank lower than specified is connected)
	Overload capability	150%/60 s, 200%/3 s for CT; 120%/60 s VT
Frequency set value	0 to 10 VDC (10 K $\Omega$ ), -10 to 10 VDC (10 K $\Omega$ ), 4 to 20 mA (100 $\Omega$ ), RS485 Modbus, Network options	
V/f Characteristics	V/f optionally changeable at base frequencies of 30 to 400 Hz, V/f braking constant torque, reduction torque, sensor-less vector control, sensor-less vector control at 0 Hz	
Functionality	Input signals	8 terminals, NO/NC switchable, sink/source logic switchable [Terminal function] 8 functions can be selected from among 61. Reverse (RV), Multi-step speed setting binary 1 (CF1), Multi-step speed setting binary 2 (CF2), Multi-step speed setting binary 3 (CF3), Multi-step speed setting binary 4 (CF4), Jogging (JG), DC injection braking (DB), 2nd control (SET), 2-step acceleration/deceleration (2CH), Free-run stop (FRS), External trip (EXT), USP function (USP), Commercial switching (CS), Soft lock (SFT), Analog input switching (AT), 3rd control (SET3), Reset (RS), 3-wire start (STA), 3-wire stop (STP), 3-wire forward/reverse (F/R), PID enabled/disabled (PID), PID integral reset (PIDC), Control gain switching (CAS), UP/DWN function accelerated (UP), UP/DWN function decelerated (DWN), UP/DWN function data clear (UDC), Forced operator (OPE), Multi-step speed setting bit 1 (SF1), Multi-step speed setting bit 2 (SF2), Multi-step speed setting bit 3 (SF3), Multi-step speed setting bit 4 (SF4), Multi-step speed setting bit 5 (SF5), Multi-step speed setting bit 6 (SF6), Multi-step speed setting bit 7 (SF7), Overload limit switching (OLR), Torque limit enabled (TL), Torque limit switching 1 (TRQ1), Torque limit switching 2 (TRQ2), P/PI switching (PPI), Brake confirmation (BOK), Orientation (ORT), LAD cancel (LAC), Position deviation clear (PCLR), Pulse train position command input permission (STAT), Frequency addition function (ADD), Forced terminal block (F-TM), Torque reference input permission (ATR), Integrated power clear (KHC), Servo ON (SON), Preliminary excitation (FOC), Analog command on hold (AHD), Position command selection 1 (CP1), Position command selection 2 (CP2), Position command selection 3 (CP3), Zero return limit signal (ORL), Zero return startup signal (ORG), Forward driving stop (FOT), Reverse driving stop (ROT), Speed/Position switching (SPD), Pulse counter (PCNT), Pulse counter clear (PCC), No allocation (no)
	Output signals	5 open collector output terminals: NO/NC switchable, sink/source logic switchable 1 relay (SPDT contact) output terminal: NO/NC switchable [Terminal function] 6 functions can be selected from among 45. Signal during RUN (RUN), Constant speed arrival signal (FA1), Over set frequency arrival signal (FA2), Overload warning (OL), Excessive PID deviation (OD), Alarm signal (AL), Set-frequency-only arrival signal (FA3), Overtorque (OTQ), Signal during momentary power interruption (IP), Signal during undervoltage (UV), Torque limit (TRQ), RUN time exceeded (RNT), Power ON time exceeded (ONT), Thermal warning (THM), Brake release (BRK), Brake error (BER), 0-Hz signal (ZS), Excessive speed deviation (DSE), Position ready (POK), Set frequency exceeded 2 (FA4), Set frequency only 2 (FA5), Overload warning 2 (OL2), Analog FV disconnection detection (FVDc), Analog FI disconnection detection (FIDc), Analog FE disconnection detection (FEDc), PID FB status output (FBV), Network error (NDC), Logic operation output 1 (LOG1), Logic operation output 2 (LOG2), Logic operation output 3 (LOG3), Logic operation output 4 (LOG4), Logic operation output 5 (LOG5), Logic operation output 6 (LOG6), Capacitor life warning (WAC), Cooling fan life warning (WAF), Starting contact signal (FR), Fin overheat warning (OHF), Light load detection signal (LOC), Operation ready (IRDY), Forward run (FWR), Reverse run (RVR), Fatal fault (MJA), Window comparator FV (WCFV), Window comparator FI (WCFI), Window comparator FE (WCFE), Alarm codes 0 to 3 (ACO to AC3)
	Standard functions	V/f free setting (7), Upper/lower frequency limit, Frequency jump, Curve acceleration/deceleration, Manual torque boost level/break, Energy-saving operation, Analog meter adjustment, Starting frequency, Carrier frequency adjustment, Electronic thermal function, (free setting available), External start/end (frequency/rate), Analog input selection, Trip retry, Restart during momentary power interruption, Various signal outputs, Reduced voltage startup, Overload limit, Initialization value setting, Automatic deceleration at power-off, AVR function, Automatic acceleration/deceleration, Auto tuning (Online/Offline), High torque multi-motor operation control (sensor-less vector control of two monitors with one inverter)
	Analogue inputs	Analogue inputs 0 to 10 V and -10 to 10 V (10 K $\Omega$ ), 4 to 20 mA (100 $\Omega$ )
	Analogue outputs	Analog voltage output, Analog current output, Pulse train output
	Accel/Decel times	0.01 to 3,600.0 s (line/curve selection)
	Display	Status indicator LED's Run, Program, Power, Alarm, Hz, Amps, Volts,%
		Digital operator: Available to monitor 23 items, output current, output frequency...

Model number: 3G3RX		Specifications
Protection functions	Motor overload protection	Electronic Thermal overload relay and PTC thermistor input
	Instantaneous overcurrent	200% of rated current for 3 seconds
	Overload	150% for 1 minute
	Overvoltage	800 V for 400 V type and 400 V for 200 V type
	Momentary power loss	Decelerates to stop with DC bus controlled, coast to stop
	Cooling fin overheat	Temperature monitor and error detection
	Stall prevention level	Stall prevention during acceleration, deceleration and constant speed
	Ground fault	Detection at power on
Ambient conditions	Power charge indication	On when voltage between P and N is higher than 45V
	Degree of protection	IP20/IP00
	Ambient humidity	90% RH or less (without condensation)
	Storage temperature	-20 to 65°C (short-term temperature during transportation)
	Ambient temperature	-10 to 50°C
	Installation	Indoor (no corrosive gas, dust, etc.)
	Installation height	Max. 1,000 m
	Vibration	3G3RX-A_004 to A_220, 5.9 m/s <sup>2</sup> (0.6G), 10 to 55 Hz 3G3RX-A_300 to B_13K, 2.94 m/s <sup>2</sup> (0.3G), 10 to 55 Hz

3G3RX 200 V class

Three-phase: 3G3RX-		A2004	A2007	A2015	A2022	A2037	A2055	A2075	A2110	A2150	A2185	A2220	A2300	A2370	A2450	A2550		
Max. applicable motor 4P kW <sup>*1</sup>	at CT	0.4	0.75	1.5	2.2	3.7	5.5	7.5	11	15	18.5	22	30	37	45	55		
	at VT	0.75	1.5	2.2	3.7	5.5	7.5	11	15	18.5	22	30	37	45	55	75		
Output characteristics	Inverter capacity kVA	200 V	at CT	1.0	1.7	2.5	3.6	5.7	8.3	11.0	15.9	22.1	26.3	32.9	41.9	50.2	63.0	76.2
			at VT	1.3	2.1	3.2	4.1	6.7	10.4	15.2	20.0	26.3	29.4	39.1	49.5	59.2	72.7	93.5
	240 V	at CT	1.2	2.0	3.1	4.3	6.8	9.9	13.3	19.1	26.6	31.5	39.4	50.2	60.2	75.6	91.4	
		at VT	1.5	2.6	3.9	5.0	8.1	12.4	18.2	24.1	31.5	35.3	46.9	59.4	71.0	87.2	112.2	
	Rated output current (A)	at CT	3.0	5.0	7.5	10.5	16.5	24	32	46	64	76	95	121	145	182	220	
		at VT	3.7	6.3	9.4	12	19.6	30	44	58	73	85	113	140	169	210	270	
Max. output voltage		Proportional to input voltage: 0 to 240 V																
Max. output frequency		400 Hz																
Power supply	Rated input voltage and frequency		3-phase 200 to 240 V 50/60 Hz															
	Allowable voltage fluctuation		-15% to 10%															
	Allowable frequency fluctuation		5%															
Power supply	Regenerative braking		Internal BRD circuit (external discharge resistor)											External regenerative braking unit				
	Minimum connectable resistance		50	50	35	35	35	16	10	10	7.5	7.5	5					
Degree of protection		IP20																
Cooling method		Forced air cooling																

\*1 Based on a standard 3-Phase motor.

3G3RX 400 V class

Three-phase: 3G3RX-		A4004	A4007	A4015	A4022	A4040	A4055	A4075	A4110	A4150	A4185	A4220	A4300	A4370	A4450	A4550	B4750	B4900	B411K	B413K		
Max. applicable motor 4P kW <sup>*1</sup>	at CT	0.4	0.75	1.5	2.2	4.0	5.5	7.5	11	15	18.5	22	30	37	45	55	75	90	110	132		
	at VT	0.75	1.5	2.2	4.0	5.5	7.5	11	15	18.5	22	30	37	45	55	75	90	110	132	160		
Output characteristics	Inverter capacity kVA	400 V	at CT	1.0	1.7	2.5	3.6	6.2	9.7	13.1	17.3	22.1	26.3	33.2	40.1	51.9	63.0	77.6	103.2	121.9	150.3	180.1
			at VT	1.3	2.1	3.3	4.6	7.7	11.0	15.2	20.9	25.6	30.4	39.4	48.4	58.8	72.7	93.5	110.8	135	159.3	200.9
	480 V	at CT	1.2	2.0	3.1	4.3	7.4	11.6	15.8	20.7	26.6	31.5	39.9	48.2	62.3	75.6	93.1	123.8	146.3	180.4	216.1	
		at VT	1.5	2.5	4.0	5.5	9.2	13.3	18.2	24.1	30.7	36.5	47.3	58.1	70.6	87.2	112.2	133	162.1	191.2	241.1	
	Rated output current (A)	at CT	1.5	2.5	3.8	5.3	9.0	14	19	25	32	38	48	58	75	91	112	149	176	217	260	
		at VT	1.9	3.1	4.8	6.7	11.1	16	22	29	37	43	57	70	85	105	135	160	195	230	290	
Max. output voltage		Proportional to input voltage: 0 to 480 V																				
Max. output frequency		400 Hz																				
Power supply	Rated input voltage and frequency		3-phase 380 to 480 V 50/60 Hz																			
	Allowable voltage fluctuation		-15% to 10%																			
	Allowable frequency fluctuation		5%																			
Power supply	Regenerative braking		Internal BRD circuit (external discharge resistor)											External regenerative braking unit								
	Minimum connectable resistance		100	100	100	100	70	70	35	35	24	24	20									
Degree of protection		IP20																IP00				
Cooling method		Forced air cooling																				

\*1 Based on a standard 3-Phase motor.

Dimensions

3G3RX inverter

Figure 1

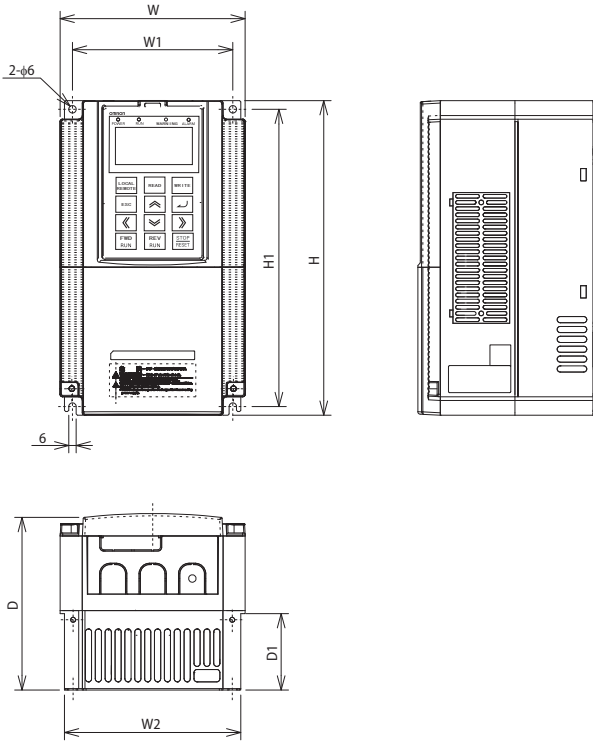

Figure 2

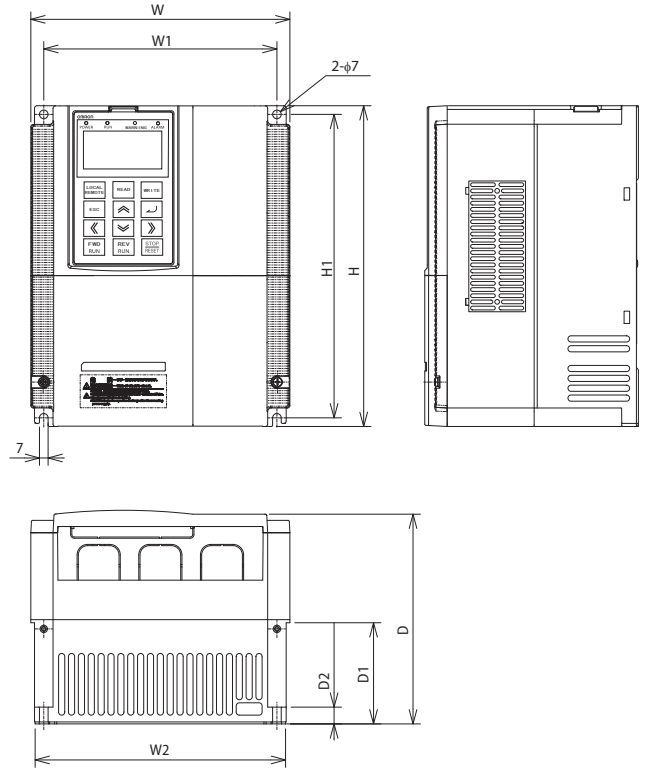

Figure 3

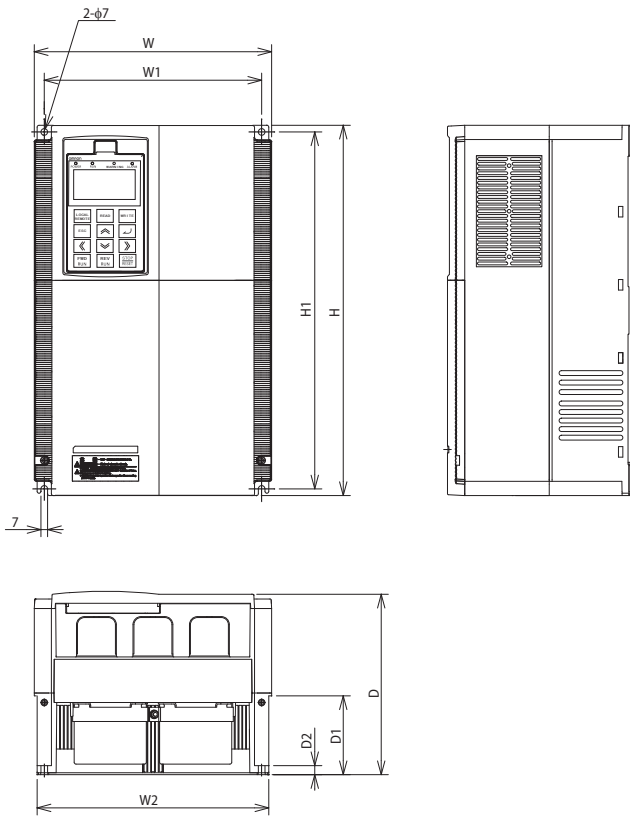

Figure 4

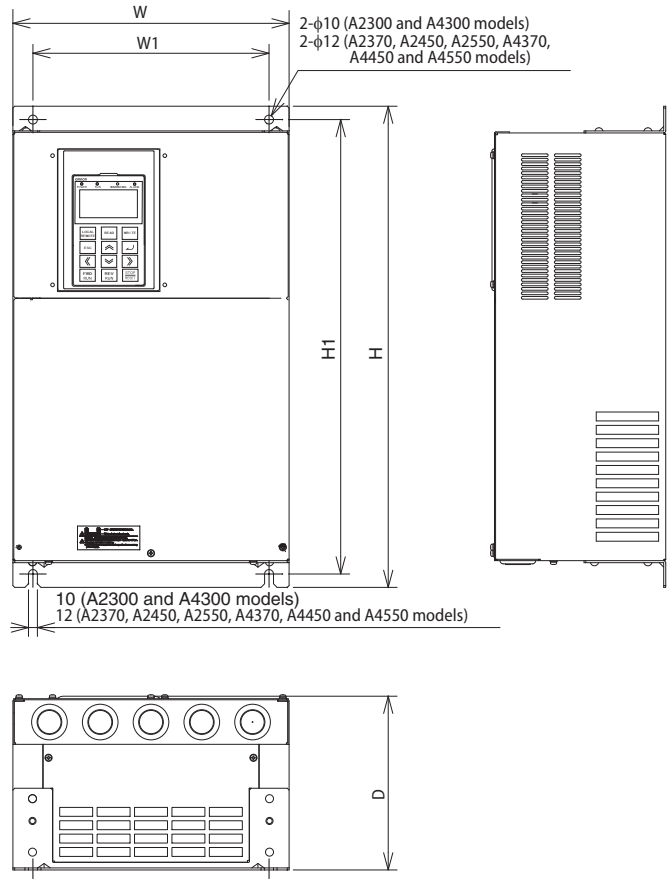
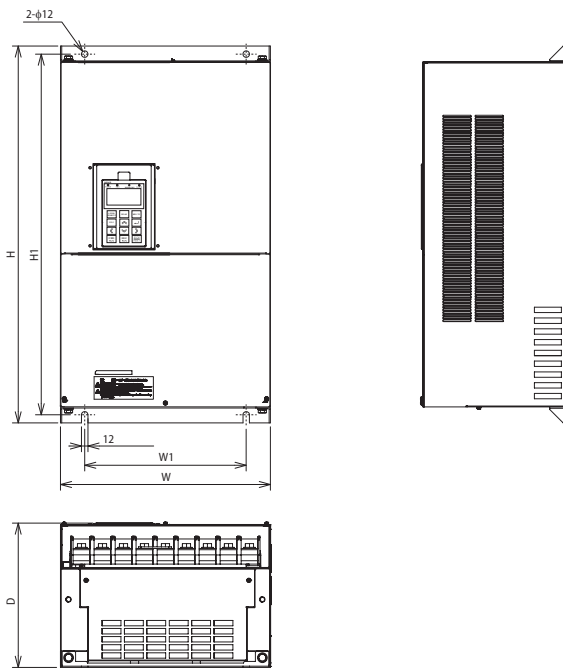

Figure 5



Voltage class	Inverter model	Figure	Dimensions in mm								Weight (kg)									
			W	W1	W2	H	H1	D	D1	D2										
Three-phase 200 V	3G3RX-A2004	1	150	130	143	255	241	140	62	-	3.5									
	3G3RX-A2007																			
	3G3RX-A2015																			
	3G3RX-A2022																			
	3G3RX-A2037																			
	3G3RX-A2055	2	210	189	203	260	246	170	82	13.6	6									
	3G3RX-A2075																			
	3G3RX-A2110																			
	3G3RX-A2150	3	250	229	244	390	376	190	83	9.5	14									
	3G3RX-A2185																			
	3G3RX-A2220																			
	3G3RX-A2300																			
	3G3RX-A2370	4	310	265	-	540	510	195	-	-	20									
	3G3RX-A2450		390	300	-	550	520	250	-	-	30									
3G3RX-A2550	480		380	-	700	670	250	-	-	43										
Three-phase 400 V	3G3RX-A4004	1	150	130	143	255	241	140	62	-	3.5									
	3G3RX-A4007																			
	3G3RX-A4015																			
	3G3RX-A4022																			
	3G3RX-A4040																			
	3G3RX-A4055	2	210	189	203	260	246	170	82	13.6	6									
	3G3RX-A4075																			
	3G3RX-A4110																			
	3G3RX-A4150	3	250	229	244	390	376	190	83	9.5	14									
	3G3RX-A4185																			
	3G3RX-A4220																			
	3G3RX-A4300																			
	3G3RX-A4370	4	310	265	-	540	510	195	-	-	22									
	3G3RX-A4450		390	300	-	550	520	250	-	-	30									
	3G3RX-A4550																			
	3G3RX-B4750		5	390	300	-	700	670	270	-	-	60								
	3G3RX-B4900																			
	3G3RX-B411K	480											380	-	740	710	270	-	-	80
	3G3RX-B413K																			

Rasmi filters

Footprint dimensions

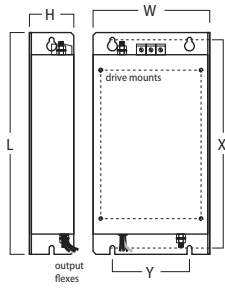

Book type dimensions

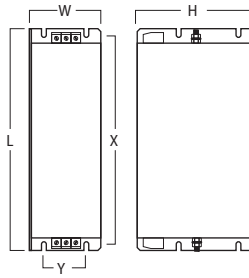

Block type dimensions

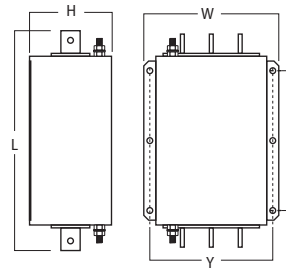

Voltage class	Inverter model	Rasmi model	Filter type	Dimensions in mm						Weight (kg)
				L	W	H	X	Y	M	
3-phase 200 V	3G3RX-A2004	AX-FIR2018-RE	Footprint	305	152	45	290	110	M5	2.0
	3G3RX-A2007									
	3G3RX-A2015									
	3G3RX-A2022									
	3G3RX-A2037									
	3G3RX-A2055	AX-FIR2053-RE	Block	320	212	56	296	189	M6	2.5
	3G3RX-A2075									
	3G3RX-A2110									
	3G3RX-A2150	AX-FIR2110-RE	Book	455	110	240	414	80		8.0
	3G3RX-A2185									
	3G3RX-A2220									
	3G3RX-A2300	AX-FIR2145-RE	Block	386	260	135	240	235	-	13
	3G3RX-A2370									
3G3RX-A2450	AX-FIR3250-RE	Block	386	260	135	240	235	-	13.2	
3G3RX-A2550										
3-phase 400 V	3G3RX-A4004	AX-FIR3010-RE	Footprint	305	152	45	290	110	M5	1.4
	3G3RX-A4007									
	3G3RX-A4015									
	3G3RX-A4022									
	3G3RX-A4040									
	3G3RX-A4055	AX-FIR3030-RE	Block	312	212	50	296	189	M6	2.2
	3G3RX-A4075									
	3G3RX-A4110									
	3G3RX-A4150	AX-FIR3053-RE	Block	451	252	60	435	229	M6	4.5
	3G3RX-A4185									
	3G3RX-A4220									
	3G3RX-A4300	AX-FIR3064-RE	Block	598	310	70	578	265	M8	7.0
	3G3RX-A4370									
	3G3RX-A4450	AX-FIR3100-RE	Block	486	110	240	414	80	-	8.0
	3G3RX-A4550									
	3G3RX-B4750	AX-FIR3130-RE	Block	386	260	135	240	235	-	13.0
	3G3RX-B4900									
3G3RX-B411K	AX-FIR3320-RE	Block	386	260	135	240	235	-	13.2	
3G3RX-B413K										

Input AC reactor

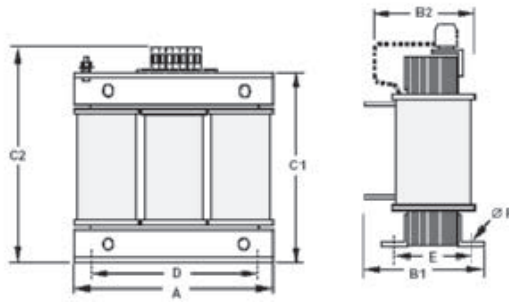

Voltage class	Reference	Dimensions in mm									
		A	B1	B2	C1	C2	D	E	F	Weight (kg)	
3-phase 200 V	AX-RAI02800080-DE	120	-	70	-	120	80	52	5.5	1.78	
	AX-RAI00880200-DE			80				62		2.35	
	AX-RAI00350335-DE	180	-	85	-	190	140	55	6	5.5	
	AX-RAI00180670-DE			205						140	55
	AX-RAI00091000-DE					105	140	55			
	AX-RAI00071550-DE			120						-	150
AX-RAI00042300-DE											
3-phase 400 V	AX-RAI07700050-DE	120	-	70	-	120	80	52	5.5	1.78	
	AX-RAI03500100-DE			80				62		2.35	
	AX-RAI01300170-DE	180	-	75	-	195	140	55	6	5.5	
	AX-RAI00740335-DE			85						190	140
	AX-RAI00360500-DE			105		205	140	55			
	AX-RAI00290780-DE									240	-
	AX-RAI00191150-DE										
	AX-RAI00111850-DE	180	-	-	210	-	-	-	-	-	25.4
	AX-RAI00072700-DE										

DC reactor

Figure 1

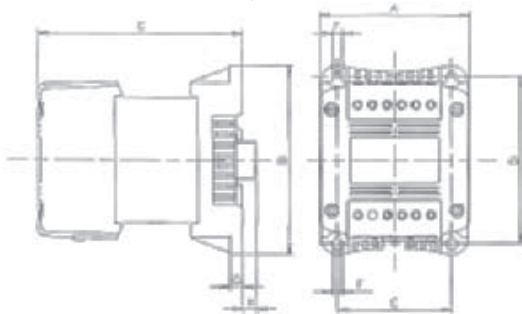
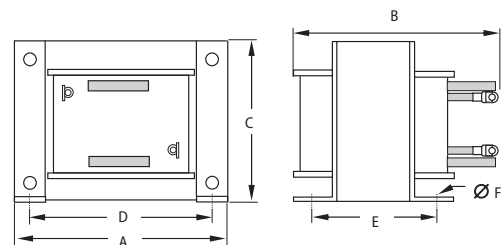

Figure 2



Voltage class	Reference	Fig	Dimensions in mm								
			A	B	C	D	E	F	G	H	Weight (kg)
3-phase 200 V	AX-RC10700032-DE	1	84	113	96	101	66	5	7.5	2	1.22
	AX-RC06750061-DE				105						1.60
	AX-RC03510093-DE				116						1.95
	AX-RC02510138-DE		108	135	124	120	82	6.5	9.5	9.5	3.20
	AX-RC01600223-DE				136						5.20
	AX-RC01110309-DE				146						6.00
	AX-RC00840437-DE		150	177	160	160	115	-	2	-	11.4
	AX-RC00590614-DE				183						14.3
	AX-RC00440859-DE										
	AX-RC00301275-DE	2	195	161	163	185	88	10	-	-	17.0
	AX-RC00231662-DE			196							25.0
	AX-RC00192015-DE		240	188	200	228	109	12	-	-	34.0
	AX-RC00162500-DE			208							42.0
	AX-RC00133057-DE			228							48.0

Voltage class	Reference	Fig	Dimensions in mm								Weight (kg)					
			A	B	C	D	E	F	G	H						
3-phase 400 V	AX-RC43000020-DE	1	84	113	96	101	66	5	7.5	2	1.22					
	AX-RC27000030-DE				105						1.60					
	AX-RC14000047-DE				116						1.95					
	AX-RC06400116-DE		108	135	133	120	82	6.5	9.5	9.5	3.70					
	AX-RC04410167-DE				120						152	136	135	94	7	5.20
	AX-RC03350219-DE				146						6.00					
	AX-RC02330307-DE		150	177	160	160	115	7	2		11.4					
	AX-RC01750430-DE				183						14.3					
	AX-RC01200644-DE				2						195	161	163	185	88	10
	AX-RC00920797-DE	196	123	25.5												
	AX-RC00741042-DE	240	188	200		228	109	12		34.0						
	AX-RC00611236-DE		198							38.0						
	AX-RC00501529-DE		228							48.0						
	AX-RC00372094-DE	300	230	256		250	160					49.0				
	AX-RC00312446-DE			245								52.5				
	AX-RC00252981-DE			250								79.0				
	AX-RC00213613-DE															

Output AC reactor

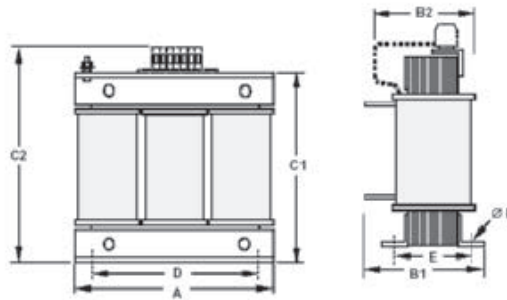

Voltage class	Reference	Dimensions in mm								Weight (kg)
		A	B1	B2	C1	C2	D	E	F	
3-phase 200 V	AX-RAO11500026-DE	120	-	70	-	120	80	52	5.5	1.78
	AX-RAO07600042-DE	120	-	70	-	120	80	52	5.5	1.78
	AX-RAO04100075-DE	120	-	80	-	120	80	62	5.5	2.35
	AX-RAO03000105-DE	120	-	80	-	120	80	62	5.5	2.35
	AX-RAO01830160-DE	180	-	85	-	195	140	55	6	5.5
	AX-RAO01150220-DE	180	-	85	-	195	140	55	6	5.5
	AX-RAO00950320-DE	180	-	85	-	210	140	55	6	6.5
	AX-RAO00630430-DE	180	-	95	-	210	140	65	6	9.1
	AX-RAO00490640-DE	180	-	105	-	210	140	75	6	11.7
	AX-RAO00390800-DE	240	-	110	-	275	200	75	6	16.0
	AX-RAO00330950-DE	240	-	110	-	275	200	75	6	16.0
	AX-RAO00251210-DE	240	-	110	-	300	200	75	6	16.0
	AX-RAO00191450-DE	240	130	-	215	-	200	85	6	18.6
	AX-RAO00161820-DE	240	160	-	215	-	200	110	6	27.0
	AX-RAO00132200-DE	300	165	-	300	-	200	125	6	33.5



Voltage class	Reference	Dimensions in mm								
		A	B1	B2	C1	C2	D	E	F	Weight (kg)
3-phase 400 V	AX-RAO16300038-DE	120	-	80	-	120	80	62	5.5	2.35
	AX-RAO11800053-DE	120	-	80	-	120	80	62	5.5	2.35
	AX-RAO07300080-DE	180	-	85	-	195	140	55	6	5.5
	AX-RAO04600110-DE	180	-	85	-	195	140	55	6	5.5
	AX-RAO03600160-DE	180	-	85	-	210	140	55	6	6.5
	AX-RAO02500220-DE	180	-	95	-	210	140	65	6	9.1
	AX-RAO02000320-DE	240	-	110	-	275	200	75	6	16.0
	AX-RAO01650400-DE	240	-	110	-	275	200	75	6	16.0
	AX-RAO01300480-DE	240	-	110	-	275	200	75	6	16.0
	AX-RAO01030580-DE	240	-	110	-	281	200	75	6	16.0
	AX-RAO00800750-DE	240	-	120	-	281	200	85	6	18.6
	AX-RAO00680900-DE	240	-	150	-	281	200	110	6	27.0
	AX-RAO00531100-DE	300	-	125	-	350	200	105	6	27.9
	AX-RAO00401490-DE	300	170	-	270	-	200	125	6	44.0
	AX-RAO00331760-DE	300	170	-	270	-	200	125	6	44.0
AX-RAO00262170-DE	360	230	-	315	-	300	150	8	55.0	
AX-RAO00212600-DE	420	240	-	370	-	300	150	8	75.0	

Chokes

Reference	Diameter	Motor kW	Dimensions in mm							Weight (kg)
			L	W	H	X	Y	m		
AX-FER2102-RE	21	<2.2	85	22	46	70	-	5	0.1	
AX-FER2515-RE	25	<15	105	25	62	90	-	5	0.2	
AX-FER5045-RE	50	<45	150	50	110	125	30	5	0.7	
AX-FER6055-RE	60	355	200	65	170	180	45	6	1.7	

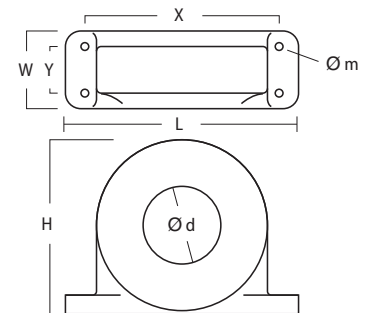

DC Supply with Regenerative Active Front End

Regenerative DC bus supply

Figure 1

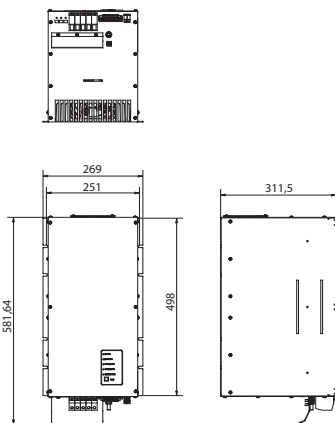

Figure 2

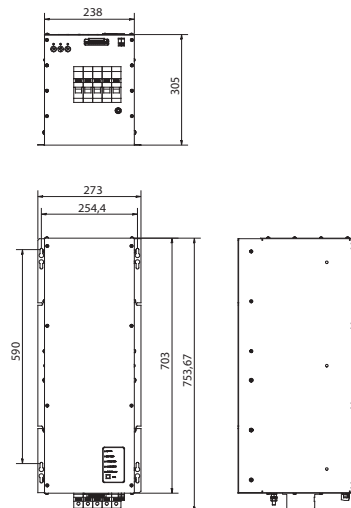
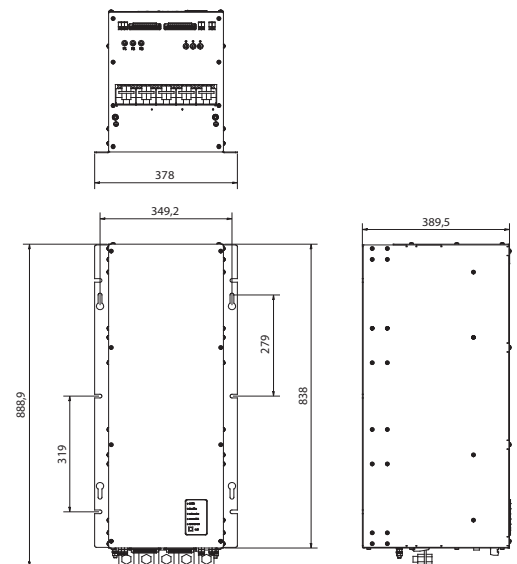

Figure 3



Reference	Fig	Weight (kg)
RFE-B3 30-400-50-230-A-RVE	1	37
RFE-B3 45-400-50-230-A-RVE		38
RFE-B3 60-400-50-230-A-RVE	2	45
RFE-B3 80-400-50-230-A-RVE		52
RFE-B3 100-400-50-230-A-RVE		65
RFE-B3 125-400-50-230-A-RVE	3	87
RFE-B3 150-400-50-230-A-RVE		89
RFE-B3 200-400-50-230-A-RVE		100



Regenerative Braking unit

Figure 1

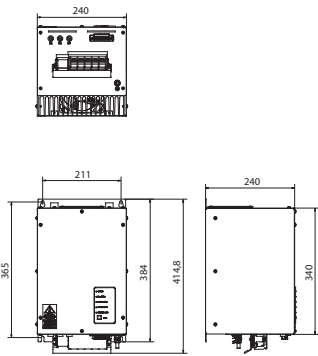

Figure 2

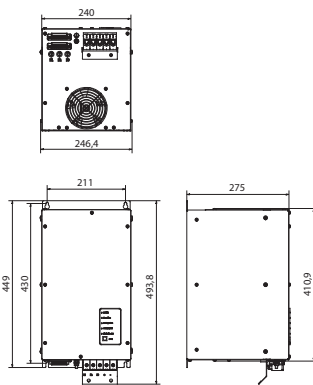

Figure 3

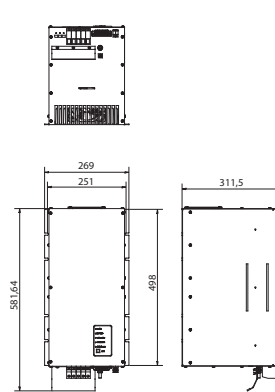

Figure 4

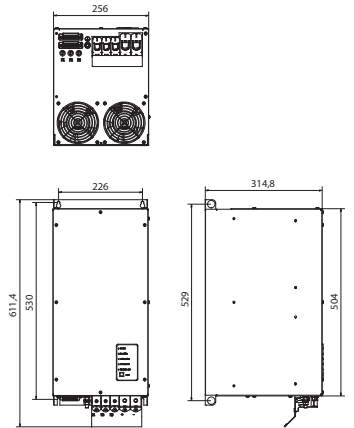

Figure 5

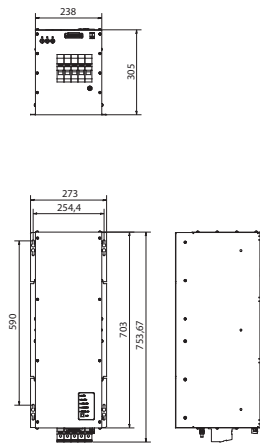

Figure 6

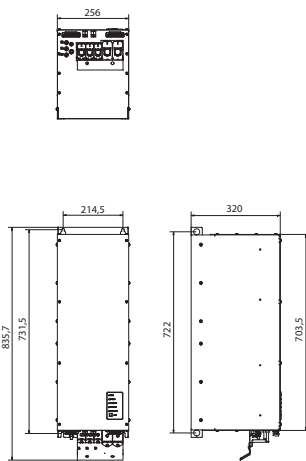
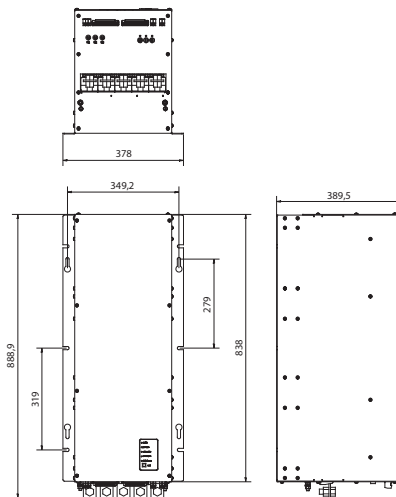

Figure 7



Models for Low Duty applications (50%)	Fig	Weight (kg)	Models for High Duty applications	Fig	Weight (kg)
RLD-E0 8-400-50-0-A-RVE	1	16	RHD-B0 7-400-50-0-A-RVE	1	17
RLD-E0 12-400-50-0-A-RVE		17	RHD-B0 13-400-50-0-A-RVE		18
RLD-E0 16-400-50-0-A-RVE		18	RHD-B0 18-400-50-0-A-RVE		20
RLD-E0 20-400-50-0-A-RVE	2	22	RHD-B0 24-400-50-0-A-RVE	3	32,5
RLD-E0 24-400-50-0-A-RVE			RHD-B0 30-400-50-230-A-RVE		
RLD-E0 32-400-50-0-A-RVE			RHD-B0 50-400-50-230-A-RVE		
RLD-E0 40-400-50-0-A-RVE	4	23	RHD-B0 70-400-50-230-A-RVE	5	40
RLD-E0 48-400-50-0-A-RVE		27	RHD-B0 100-400-50-230-A-RVE		51
RLD-E0 58-400-50-0-A-RVE		28	RHD-B0 125-400-50-230-A-RVE		85
RLD-E0 80-400-50-0-A-RVE	4	30	RHD-B0 150-400-50-230-A-RVE	7	91
RLD-E0 95-400-50-0-A-RVE		35			100
RLD-E0 116-400-50-0-A-RVE		38			
RLD-E0 140-400-50-0-A-RVE	6	52			
RLD-E0 170-400-50-230-A-RVE		60			
RLD-E0 200-400-50-230-A-RVE		68			

Braking unit

Reference	Dimensions in mm					
	B	B1	H	H1	T	S
AX-BCR4015045-TE	82.5	40.5	150	138	220	6
AX-BCR4017068-TE						
AX-BCR2035090-TE	130	64.5	205	193	208	6
AX-BCR2070130-TE						
AX-BCR4035090-TE						
AX-BCR4070130-TE						
AX-BCR4090240-TE	131	64.5	298	280	300	9

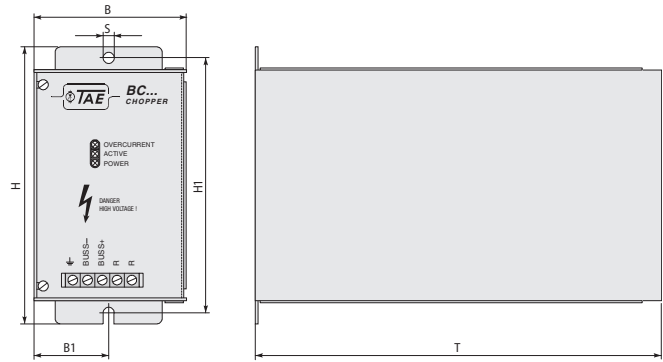

Resistor

AX-REM00K15xxx

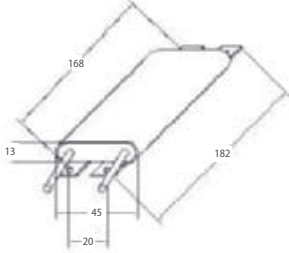

Fig 3

Fig 1

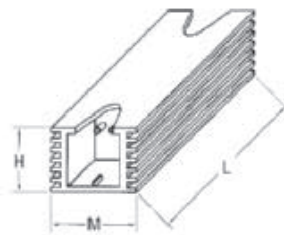

Fig 4

Fig 2

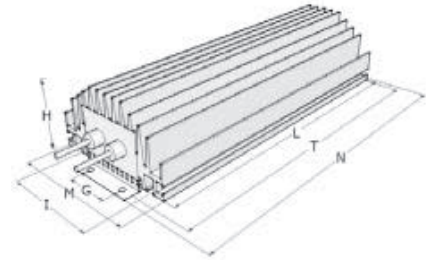
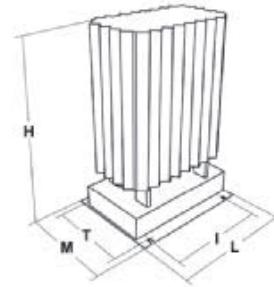
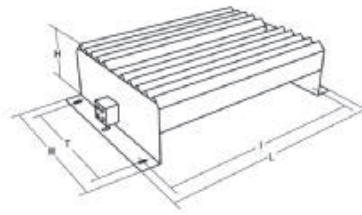
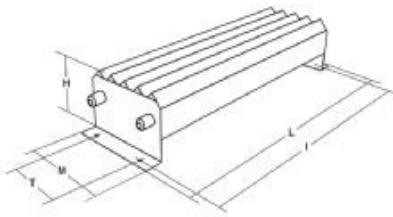

Fig 5



Reference	Fig	Dimensions in mm								Weight (kg)
		L	H	M	I	T	G	N		
AX-REM00K2070-IE	1	105	27	36	94	-	-	-	-	0.2
AX-REM00K2120-IE										
AX-REM00K2200-IE										
AX-REM00K4075-IE										
AX-REM00K4035-IE		200	27	36	189					
AX-REM00K4030-IE										
AX-REM00K5120-IE										
AX-REM00K6100-IE										
AX-REM00K6035-IE	320	27	36	309						
AX-REM00K6035-IE										
AX-REM00K9070-IE	2	200	61	100	74.5	216	40	230	-	1.41
AX-REM00K9020-IE										
AX-REM00K9017-IE										
AX-REM01K9070-IE	3	365	73	105	350	70	-	-	-	4
AX-REM01K9017-IE										
AX-REM02K1070-IE	4	310	100	240	295	210	-	-	-	7
AX-REM02K1017-IE										
AX-REM03K5035-IE										
AX-REM03K5010-IE	365	100	240	350	210	-	-	-	-	8
AX-REM03K5010-IE										
AX-REM19K0006-IE	5	206	350	140	190	50	-	-	-	8.1
AX-REM19K0008-IE										
AX-REM19K0020-IE										
AX-REM19K0030-IE										
AX-REM38K0012-IE										

Installation

Standard connections

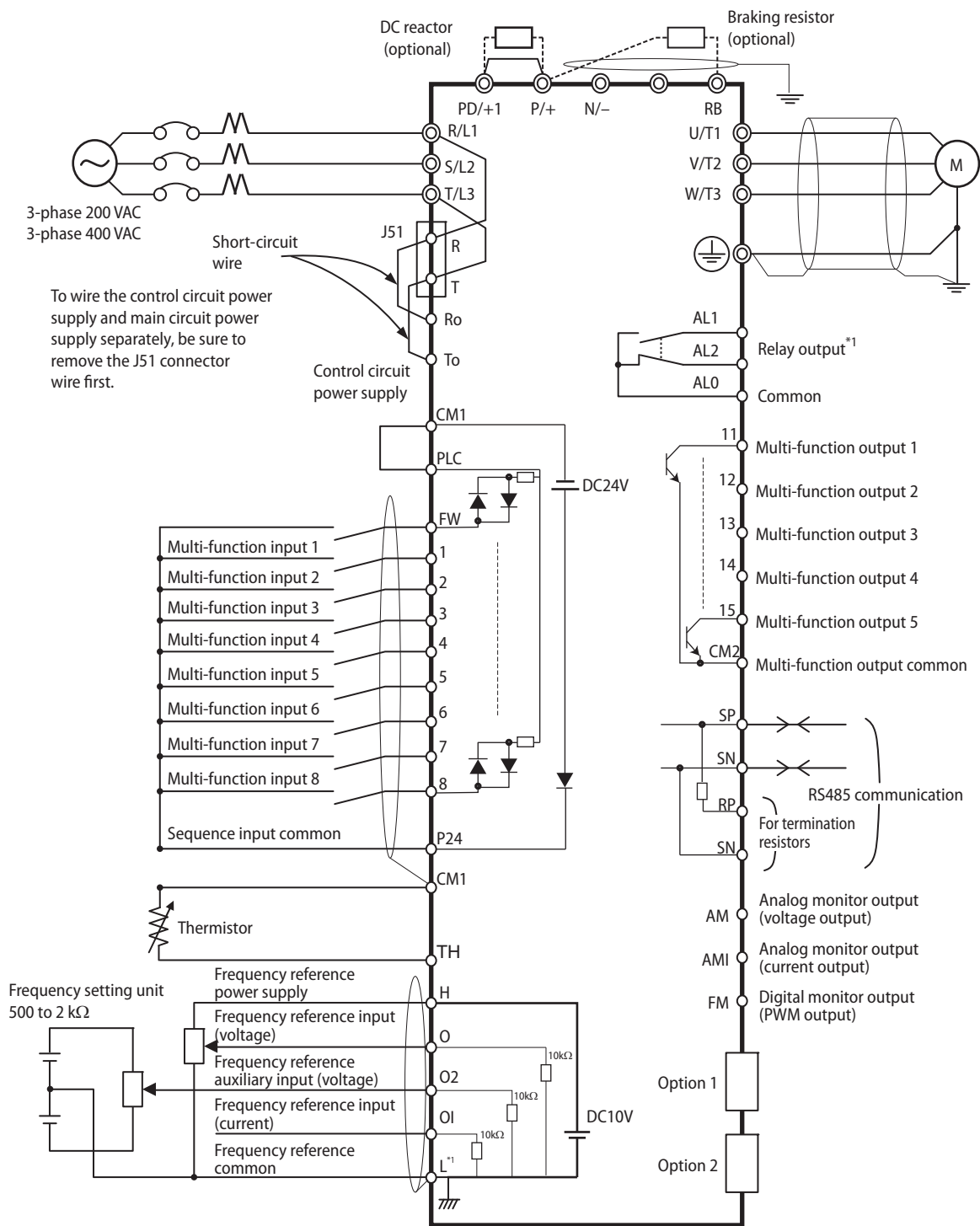

\*1 L is the common reference for analog input and also for the analog output.

Terminal connections

Terminal	Name	Function (signal level)
R/L1, S/L2, T/L3	Main circuit power supply input	Used to connect line power to the drive
U/T1, V/T2, W/T3	Inverter output	Used to connect the motor
PD/+1, P/+	External DC reactor terminal	Normally connected by the short-circuit bar. Remove the short-circuit bar between +1 and P/+2 when a DC reactor is connected
P/+, RB	Braking resistor connection terminal	Connect option braking resistor (if a braking torque is required)
P/+, N/-	Regenerative braking unit connection terminal	Connect optional regenerative braking units
PE	Grounding	For grounding (grounding should conform to the local grounding code)

## Control circuit

Type	No.	Signal name	Function (default)	Signal level
Frequency reference input	H	Frequency reference power supply	10 VDC 20 mA max	
	0	Voltage frequency reference input	0 to 12 VDC (10 k $\Omega$ )	
	O2	Voltage auxiliary frequency reference	0 to $\pm$ 12 VDC (10 k $\Omega$ )	
	O1	Current frequency reference input	4 to 20 mA (100 $\Omega$ )	
	L	Frequency reference common	Common terminal for analog monitor (AM, AMI) terminals	
Monitor output	AM	Multi-function analog voltage output	Factory setting: Output frequency	2 mA max
	AMI	Multi-function analog current output	Factory setting: Output frequency	4 to 20 mA (max imp 250 $\Omega$ )
	FM	PWM monitor output	Factory setting: Output frequency	0 to 10 VDC (max 3.6 kHz)
Power supply	P24	Internal 24 VDC	Power supply for contact input signal	100 mA max
	CM1	Input common	Common terminal for P24, TH and FM digital monitor	
Function selection	FW	Forward rotation command terminal	Motor runs in forwards direction when FW is ON	27 VDC max Input impeded 4.7 k $\Omega$ max current 5.6 mA On: 18 VDC or more
	1	Multi-function input	Factory setting: Reverse (RV)	
	2		Factory setting: External trip (EXT)	
	3		Factory setting: Reset (RS)	
	4		Factory setting: Multi-step speed reference 1 (CF1)	
	5		Factory setting: Multi-step speed reference 2 (CF2)	
	6		Factory setting: Jogging (JG)	
	7		Factory setting: Second control (SET)	
	8		Factory setting: No allocation (NO)	
PLC	Multi-function input common	Sink logic: Short-circuiting P24 and PLC Source logic: Short-circuiting PLC and CM1 With external supply remove short-circuit bar		
Status/Factor	11	Multi-function output	Factory setting: During Run (RUN)	27 VDC max 50 mA max
	12		Factory setting: 0 Hz signal (ZS)	
	13		Factory setting: Overload warning (OL)	
	14		Factory setting: Overtorque (OTQ)	
	15		Factory setting: Constant speed arrival (FA1)	
	CM2	Multi-function output common	Common terminal for multi-function output terminals 11 to 15	
Relay output	AL1	Relay output (Normally close)	Factory setting: Alarm output (AL)	R load AL1-AL0 250 VAC 2 A AL2-AL0 250 VAC 1 A I load 250 VAC 0.2 A
	AL2	Relay output (Normally open)	Under normal operation	
	AL0	Relay output common	MA-MC open MB-MC close	
Sensor	TH	External thermistor input terminal	SC terminal functions as the common terminal 100 m $\Omega$ minimum Impedance at temperature error: 3 kW	0 to 8 VDC
Comms	SP	RS485 Modbus terminals	-	Differential input
	SN			
	RP	RS485 terminating resistor terminals	-	
	SN			

Inverter heat loss

3G3RX 200 V class

Three-phase: 3G3RX-	A2004	A2007	A2015	A2022	A2037	A2055	A2075	A2110	A2150	A2185	A2220	A2300	A2370	A2450	A2550	
Inverter capacity kVA	200 V	1.0	1.7	2.5	3.6	5.7	8.3	11.0	15.9	22.1	26.3	32.9	41.9	50.2	63.0	76.2
	400 V	1.2	2.0	3.1	4.3	6.8	9.9	13.3	19.1	26.6	31.5	39.4	50.2	60.2	75.6	91.4
Rated output current A		3.0	5.0	7.5	10.5	16.5	24	32	46	64	76	95	121	145	182	220
Heat loss W	Losses at 70% load	64	76	102	127	179	242	312	435	575	698	820	1,100	1,345	1,625	1,975
	Losses at 100% load	70	88	125	160	235	325	425	600	800	975	1,150	1,550	1,900	2,300	2,800
Efficiency at rated output		85.1	89.5	92.3	93.2	94.0	94.4	94.6	94.8	94.9	95.0	95.0	95.1	95.1	95.1	95.1
Cooling method		Forced air cooling														

3G3RX 400 V class

Three-phase: 3G3RX-	A4004	A4007	A4015	A4022	A4040	A4055	A4075	A4110	A4150	A4185	A4220	A4300	A4370	A4450	A4550	B4750	B4900	B411K	B413K	
Inverter capacity kVA	200 V	1.0	1.7	2.5	3.6	6.2	9.7	13.1	17.3	22.1	26.3	33.2	40.1	51.9	63.0	77.6	103.2	121.9	150.3	180.1
	400 V	1.2	2.0	3.1	4.3	7.4	11.6	15.8	20.7	26.6	31.5	39.9	48.2	62.3	75.6	93.1	123.8	146.3	180.4	216.1
Rated output current A		1.5	2.5	3.8	5.3	9.0	14	19	25	32	38	48	58	75	91	112	149	176	217	260
Heat loss W	Losses at 70% load	64	76	102	127	179	242	312	435	575	698	820	1,100	1,345	1,625	1,975	2,675	3,375	3,900	4,670
	Losses at 100% load	70	88	125	160	235	325	425	600	800	975	1,150	1,550	1,900	2,300	2,800	3,800	4,800	5,550	6,650
Efficiency at rated output		85.1	89.5	92.3	93.2	94.0	94.4	94.6	94.8	94.9	95.0	95.0	95.1	95.1	95.1	95.2	95.2	95.2	95.2	95.2
Cooling method		Forced air cooling																		

Input AC reactor

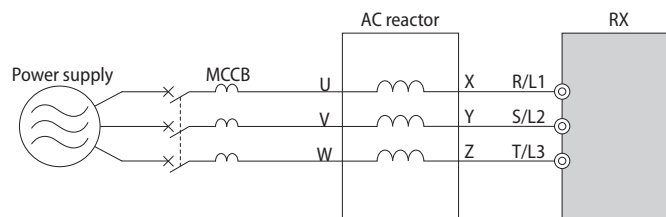

3-phase 200 V				3-phase 400 V			
Max. applicable motor output kW	Reference	Current value A	Inductance mH	Max. applicable motor output kW	Reference	Current value A	Inductance mH
0.4 to 1.5	AX-RAI02800080-DE	8.0	2.8	0.4 to 1.5	AX-RAI07700050-DE	5.0	7.7
2.2 to 3.7	AX-RAI00880200-DE	20.0	0.88	2.2 to 4.0	AX-RAI03500100-DE	10.0	3.5
5.5 to 7.5	AX-RAI00350335-DE	33.5	0.35	5.5 to 7.5	AX-RAI01300170-DE	17.0	1.3
11.0 to 15.0	AX-RAI00180670-DE	67.0	0.18	11.0 to 15.0	AX-RAI00740335-DE	33.5	0.74
18.5 to 22.0	AX-RAI00091000-DE	100.0	0.09	18.5 to 22.0	AX-RAI00360500-DE	50.0	0.36
30.0 to 37.0	AX-RAI00071550-DE	155.0	0.07	30.0 to 37.0	AX-RAI00290780-DE	78.0	0.29
45.0 to 55.0	AX-RAI00042300-DE	230.0	0.04	45.0 to 55.0	AX-RAI00191150-DE	115.0	0.19
				75.0 to 90.0	AX-RAI00111850-DE	185.0	0.11
				110.0 to 132.0	AX-RAI00072700-DE	270.0	0.07

DC reactor

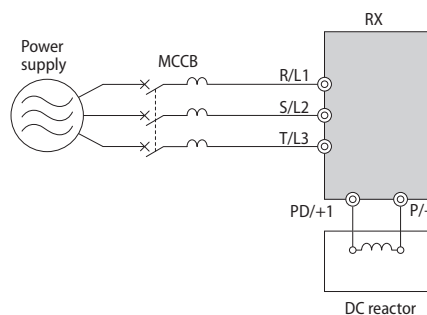

3-phase 200 V				3-phase 400 V			
Max. applicable motor output kW	Reference	Current value A	Inductance mH	Max. applicable motor output kW	Reference	Current value A	Inductance mH
0.4	AX-RC10700032-DE	3.2	10.70	0.4	AX-RC43000020-DE	2.0	43.00
0.7	AX-RC06750061-DE	6.1	6.75	0.7	AX-RC27000030-DE	3.0	27.00
1.5	AX-RC03510093-DE	9.3	3.51	1.5	AX-RC14000047-DE	4.7	14.00
2.2	AX-RC02510138-DE	13.8	2.51	2.2	AX-RC10100069-DE	6.9	10.10
3.7	AX-RC01600223-DE	22.3	1.60	4.0	AX-RC06400116-DE	11.6	6.40

3-phase 200 V				3-phase 400 V			
Max. applicable motor output kW	Reference	Current value A	Inductance mH	Max. applicable motor output kW	Reference	Current value A	Inductance mH
5.5	AX-RC01110309-DE	30.9	1.11	5.5	AX-RC04410167-DE	16.7	4.41
7.5	AX-RC00840437-DE	43.7	0.84	7.5	AX-RC03350219-DE	21.9	3.35
11.0	AX-RC00590614-DE	61.4	0.59	11.0	AX-RC02330307-DE	30.7	2.33
15.0	AX-RC00440859-DE	85.9	0.44	15.0	AX-RC01750430-DE	43.0	1.75
18.5 to 22	AX-RC00301275-DE	127.5	0.30	18.5 to 22	AX-RC01200644-DE	64.4	1.20
30	AX-RC00231662-DE	166.2	0.23	30	AX-RC00920797-DE	79.7	0.92
37	AX-RC00192015-DE	201.5	0.19	37	AX-RC00741042-DE	104.2	0.74
45	AX-RC00162500-DE	250.0	0.16	45	AX-RC00611236-DE	123.6	0.61
55	AX-RC00133057-DE	305.7	0.13	55	AX-RC00501529-DE	152.9	0.50
				75	AX-RC00372094-DE	209.4	0.37
				90	AX-RC00312446-DE	244.6	0.31
				110	AX-RC00252981-DE	298.1	0.25
				132	AX-RC00213613-DE	361.3	0.21

## Output AC reactor

3-phase 200 V				3-phase 400 V			
Max. applicable motor output kW	Reference	Current value A	Inductance mH	Max. applicable motor output kW	Reference	Current value A	Inductance mH
0.4	AX-RAO11500026-DE	2.6	11.50	0.4 to 1.5	AX-RAO16300038-DE	3.8	16.30
0.75	AX-RAO07600042-DE	4.2	7.60				
1.5	AX-RAO04100075-DE	7.5	4.10				
2.2	AX-RAO03000105-DE	10.5	3.00	2.2	AX-RAO11800053-DE	5.3	11.80
3.7	AX-RAO01830160-DE	16.0	1.83	4.0	AX-RAO07300080-DE	8.0	7.30
5.5	AX-RAO01150220-DE	22.0	1.15	5.5	AX-RAO04600110-DE	11.0	4.60
7.5	AX-RAO00950320-DE	32.0	0.95	7.5	AX-RAO03600160-DE	16.0	3.60
11	AX-RAO00630430-DE	43.0	0.63	11	AX-RAO02500220-DE	22.0	2.50
15	AX-RAO00490640-DE	64.0	0.49	15	AX-RAO02000320-DE	32.0	2.00
18.5	AX-RAO00390800-DE	80.0	0.39	18.5	AX-RAO01650400-DE	40.0	1.65
22	AX-RAO00330950-DE	95.0	0.33	22	AX-RAO01300480-DE	48.0	1.30
30	AX-RAO00251210-DE	121.0	0.25	30	AX-RAO01030580-DE	58.0	1.03
37	AX-RAO00191450-DE	145.0	0.19	37	AX-RAO00800750-DE	75.0	0.80
45	AX-RAO00161820-DE	182.0	0.16	45	AX-RAO00680900-DE	90.0	0.68
55	AX-RAO00132200-DE	220.0	0.13	55	AX-RAO00531100-DE	110.0	0.53
				75	AX-RAO00401490-DE	149.0	0.40
				90	AX-RAO00331760-DE	176.0	0.33
				110	AX-RAO00262170-DE	217.0	0.26
				132	AX-RAO00212600-DE	260.0	0.21

## Braking unit

Voltage	Reference	Specifications					
		Permanent		Peak (5 s max)		Minimum connectable resistor (Ohms)	
		Current value A	Brake power kVA	Current value A	Brake power kVA		
3-phase 200 V	AX-BCR2035090-TE	35	13	90	32	4	
	AX-BCR2070130-TE	70	25	130	47	2.8	
3-phase 400 V	AX-BCR4015045-TE	15	11	45	33	16	
	AX-BCR4017068-TE	17	13	68	51	11	
	AX-BCR4035090-TE	35	26	90	67	8.5	
	AX-BCR4070130-TE	70	52	130	97	5.5	
	AX-BCR4090240-TE	90	67	240	180	3.2	



DC Supply with Regenerative Active Front End system

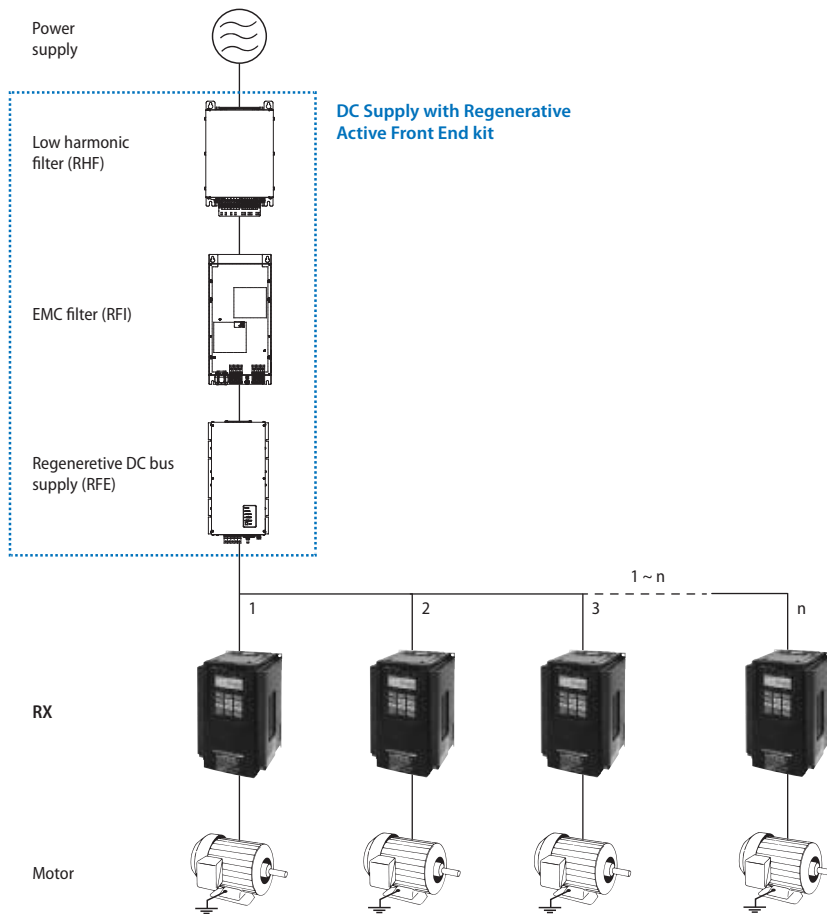

Regenerative DC bus supply

Reference: RFE-B3_	30	45	60	80	100	125	150	200		
Max. input power kW	30	45	60	80	100	125	150	200		
DC capacity $\mu\text{F}$	100		220		440		660			
Max. input current A <sup>*1</sup>	Driving	AC	65	98	130	173	217	325	433	
		DC	78	118	156	208	260	325	520	
	Braking	AC	52	78	104	139	173	217	260	346
		DC	62	97	125	167	208	260	312	415
Rated input voltage	3-phase 400 V									
Allowable voltage fluctuation	-15% to 10%									
Mains frequency	40 to 60 Hz									
Efficiency $\eta$	98%									
Degree of protection	IP20									
Ambient humidity	85% RH or less (without condensation)									
Storage temperature	-25 to 55°C									
Ambient temperature	5 to 40°C									

\*1 At nominal voltage 400 V. 1 min in 10 min.

Low harmonic filter

Reference: RHF-RA_	43	72	86	144	180	217	304	
$I_{\text{RMS}}$ current A <sup>*1</sup>	100% AC	43	72	86	144	180	217	304
	150% AC 1 min in 10 min	64,5	108	129	216	270	325,5	456
Heat loss W <sup>*1</sup>	242	352	374	488	692	743	905	
Allowable voltage fluctuation	-15% to 10%							
Power frequency	50 Hz							
Efficiency $\eta$	98,5-99,5%							
Degree of protection	IP20							
Ambient humidity	85% RH or less (without condensation)							
Storage temperature	-25 to 55°C							
Ambient temperature	-20 to 45°C							

\*1 At nominal voltage 400 V, 50 Hz.

Regenerative Braking unit system

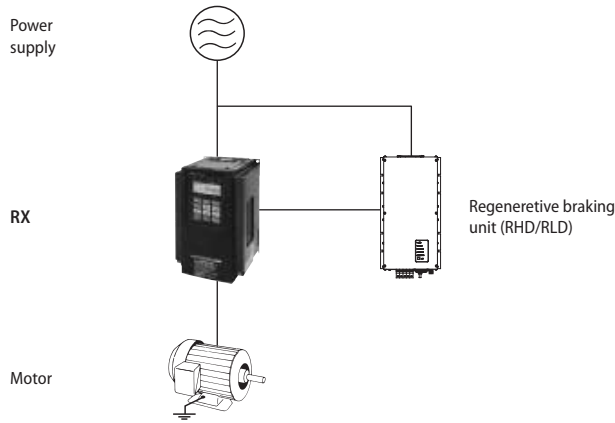

Regenerative Braking unit for Low Duty applications (50%)

Reference: RLD-E0_	8	12	16	20	24	32	40	48	58	80	95	116	140	170	200	
Max. regenerative power kW	8	12	16	20	24	32	40	48	58	80	95	116	140	170	200	
DC capacity $\mu\text{F}$	20			40			220			440			660			
Max. current A <sup>*1</sup>	DC	14	20	28	35	42	55	70	83	101	139	165	202	242	295	348
	AC	12	17	23	29	35	46	58	69	84	116	137	168	202	246	290
Allowable voltage fluctuation	-15% to 10%															
Mains frequency	50 to 60 Hz															
Efficiency $\eta$	98%															
Degree of protection	IP20															
Ambient humidity	85% RH or less (without condensation)															
Storage temperature	-25 to 55°C															
Ambient temperature	5 to 40°C															

\*1 At nominal voltage 400 V.

Regenerative Braking unit for High Duty applications

Reference: RHD-B0_	7	13	18	24	30	50	70	100	125	150	
Max. regenerative power kW	7	13	18	24	30	50	70	100	125	150	
DC capacity $\mu\text{F}$	20		100		40		220		660		
Max. current A <sup>*1</sup>	DC I 100%	12	23	31	42	52	87	122	174	218	260
	AC I <sub>eff</sub> 100%	10	19	26	35	43	72	101	144	180	217
	AC I <sub>eff</sub> 60 s in 10 min	12	23	31	42	52	86	121	173	216	260
Allowable voltage fluctuation	-15% to 10%										
Mains frequency	40 to 60 Hz										
Efficiency $\eta$	98%										
Degree of protection	IP20										
Ambient humidity	85% RH or less (without condensation)										
Storage temperature	-25 to 55°C										
Ambient temperature	5 to 40°C										

\*1 At nominal voltage 400 V.

Ordering information

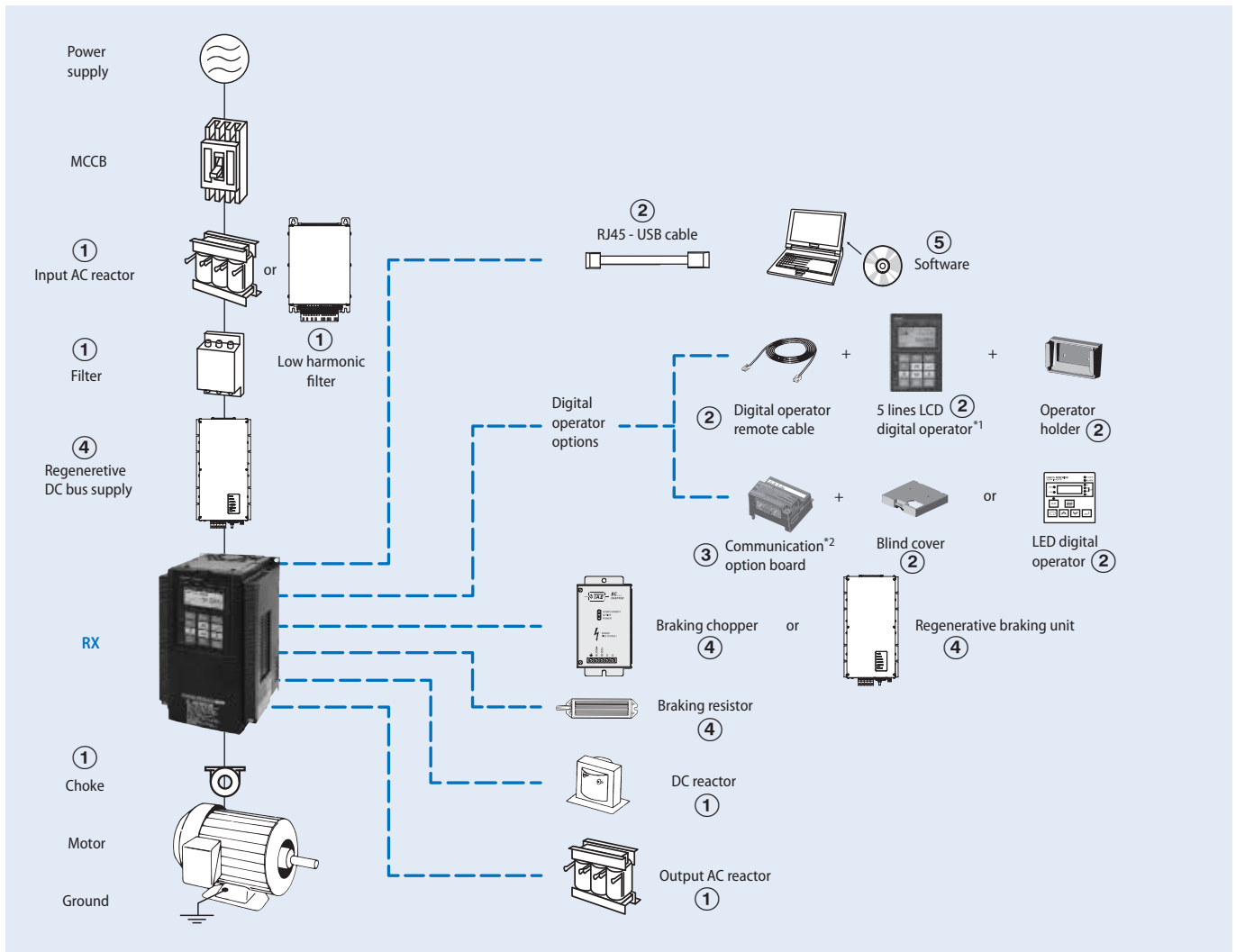

\*1 The 5 lines LCD digital operator is provided with the inverter from factory.

\*2 When a communication option board is mounted, there are two options: mount a blind cover or a LED digital operator.

3G3RX inverter

Specifications					Model	Specifications					Model
Voltage	Constant torque		Variable torque			Voltage	Constant torque		Variable torque		
	Max motor kW	Rated current A	Max motor kW	Rated current A			Max motor kW	Rated current A	Max motor kW	Rated current A	
Three-phase 200 V	0.4	3.0	0.75	3.7	3G3RX-A2004-E1F	Three-phase 400 V	0.4	1.5	0.75	1.9	3G3RX-A4004-E1F
	0.75	5.0	1.5	6.3	3G3RX-A2007-E1F		0.75	2.5	1.5	3.1	3G3RX-A4007-E1F
	1.5	7.5	2.2	9.4	3G3RX-A2015-E1F		1.5	3.8	2.2	4.8	3G3RX-A4015-E1F
	2.2	10.5	4.0	12	3G3RX-A2022-E1F		2.2	5.3	4.0	6.7	3G3RX-A4022-E1F
	4.0	16.5	5.5	19.6	3G3RX-A2037-E1F		4.0	9.0	5.5	11.1	3G3RX-A4040-E1F
	5.5	24	7.5	30	3G3RX-A2055-E1F		5.5	14	7.5	16	3G3RX-A4055-E1F
	7.5	32	11	44	3G3RX-A2075-E1F		7.5	19	11	22	3G3RX-A4075-E1F
	11	46	15	58	3G3RX-A2110-E1F		11	25	15	29	3G3RX-A4110-E1F
	15	64	18.5	73	3G3RX-A2150-E1F		15	32	18.5	37	3G3RX-A4150-E1F
	18.5	76	22	85	3G3RX-A2185-E1F		18.5	38	22	43	3G3RX-A4185-E1F
	22	95	30	113	3G3RX-A2220-E1F		22	48	30	57	3G3RX-A4220-E1F
	30	121	37	140	3G3RX-A2300-E1F		30	58	37	70	3G3RX-A4300-E1F
	37	145	45	169	3G3RX-A2370-E1F		37	75	45	85	3G3RX-A4370-E1F
	45	182	55	210	3G3RX-A2450-E1F		45	91	55	105	3G3RX-A4450-E1F
55	220	75	270	3G3RX-A2550-E1F	55	112	75	135	3G3RX-A4550-E1F		
					75	149	90	160	3G3RX-B4750-E1F		
					90	176	110	195	3G3RX-B4900-E1F		
					110	217	132	230	3G3RX-B411K-E1F		
					132	260	160	290	3G3RX-B413K-E1F		

## ① Line filter

Rasmi line filter									
3-phase 200 V					3-phase 400 V				
Model 3G3RX- _	Model	Rated current A	Leakage Nom/Max	Weight (kg)	Model 3G3RX- _	Model	Rated current A	Leakage Nom/Max	Weight (kg)
A2004/A2007/A2015/A2022/A2037	AX-FIR2018-RE	18	0.7/40 mA	2.0	A4004/A4007/A4015/A4022/A4040	AX-FIR3010-RE	10	0.3/40 mA	1.9
A2055/A2075/A2110	AX-FIR2053-RE	53	0.7/40 mA	2.5	A4055/A4075/A4110	AX-FIR3030-RE	30	0.3/40 mA	2.2
A2150/A2185/A2220	AX-FIR2110-RE	110	1.2/70 mA	8.0	A4150/A4185/A4220	AX-FIR3053-RE	53	0.8/70 mA	4.5
A2300	AX-FIR2145-RE	145	1.2/70 mA	8.6	A4300	AX-FIR3064-RE	64	3/160 mA	7.0
A2370/A2450	AX-FIR3250-RE	250	6/300 mA	13.0	A4370	AX-FIR3100-RE	100	2/130 mA	8.0
A2550	AX-FIR3320-RE	320	6/300 mA	13.2	A4450/A4550	AX-FIR3130-RE	130	2/130 mA	8.6
					B4750/B4900	AX-FIR3250-RE	250	10/500 mA	13.0
					B411K/B413K	AX-FIR3320-RE	320	10/500 mA	13.2

## ① Input AC reactor

3-phase 200 V		3-phase 400 V	
Model 3G3RX- _	Model	Model 3G3RX- _	Model
A2004/A2007/A2015	AX-RAI02800100-DE	A4004/A4007/A4015	AX-RAI07700050-DE
A2022/A2037	AX-RAI00880200-DE	A4022/A4040	AX-RAI03500100-DE
A2055/A2075	AX-RAI00350335-DE	A4055/A4075	AX-RAI01300170-DE
A2110 /A2150	AX-RAI00180670-DE	A4110/A4150	AX-RAI00740335-DE
A2185/A2220	AX-RAI00091000-DE	A4185/A4220	AX-RAI00360500-DE
A2300/A2370	AX-RAI00071550-DE	A4300/A4370	AX-RAI00290780-DE
A2450/A2550	AX-RAI00042300-DE	A4450/A4550	AX-RAI00191150-DE
		B4750/B4900	AX-RAI00111850-DE
		B411K/B413K	AX-RAI00072700-DE

## ① DC reactor

3-phase 200 V		3-phase 400 V	
Model 3G3RX- _	Model	Model 3G3RX- _	Model
A2004	AX-RC10700032-DE	A4004	AX-RC43000020-DE
A2007	AX-RC06750061-DE	A4007	AX-RC27000030-DE
A2015	AX-RC03510093-DE	A4015	AX-RC14000047-DE
A2022	AX-RC02510138-DE	A4022	AX-RC10100069-DE
A2037	AX-RC01600223-DE	A4040	AX-RC06400116-DE
A2055	AX-RC01110309-DE	A4055	AX-RC04410167-DE
A2075	AX-RC00840437-DE	A4075	AX-RC03350219-DE
A2110	AX-RC00590614-DE	A4110	AX-RC02330307-DE
A2150	AX-RC00440859-DE	A4150	AX-RC01750430-DE
A2185/A2220	AX-RC00301275-DE	A4185/A4220	AX-RC01200644-DE
A2300	AX-RC00231662-DE	A4300	AX-RC00920797-DE
A2370	AX-RC00192015-DE	A4370	AX-RC00741042-DE
A2450	AX-RC00162500-DE	A4450	AX-RC00611236-DE
A2500	AX-RC00133057-DE	A4550	AX-RC00501529-DE
		B4750	AX-RC00372094-DE
		B4900	AX-RC00312446-DE
		B411K	AX-RC00252981-DE
		B413K	AX-RC00213613-DE

## ① Chokes

Diameter	Description	Model
21	For 2.2 kW motors or below	AX-FER2102-RE
25	For 15 kW motors or below	AX-FER2515-RE
50	For 45 kW motors or below	AX-FER5045-RE
60	For 55 kW motors or above	AX-FER6055-RE

① Output AC reactor

3-phase 200 V		3-phase 400 V	
Model 3G3RX-__	Model	Model 3G3RX-__	Model
A2004	AX-RAO11500026-DE	A4004/A4007/A4015	AX-RAO16300038-DE
A2007	AX-RAO07600042-DE		
A2015	AX-RAO04100075-DE		
A2022	AX-RAO03000105-DE		
A2037	AX-RAO01830160-DE	A4022	AX-RAO11800053-DE
A2055	AX-RAO01150220-DE	A4040	AX-RAO07300080-DE
A2075	AX-RAO00950320-DE	A4055	AX-RAO04600110-DE
A2110	AX-RAO00630430-DE	A4075	AX-RAO03600160-DE
A2150	AX-RAO00490640-DE	A4110	AX-RAO02500220-DE
A2185	AX-RAO00390800-DE	A4150	AX-RAO02000320-DE
A2220	AX-RAO00330950-DE	A4185	AX-RAO01650400-DE
A2300	AX-RAO00251210-DE	A4220	AX-RAO01300480-DE
A2370	AX-RAO00191450-DE	A4300	AX-RAO01030580-DE
A2450	AX-RAO00161820-DE	A4370	AX-RAO00800750-DE
A2500	AX-RAO00132200-DE	A4450	AX-RAO00680900-DE
		A4550	AX-RAO00531100-DE
		B4750	AX-RAO00401490-DE
		B4900	AX-RAO00331760-DE
		B411K	AX-RAO00262170-DE
		B413K	AX-RAO00212600-DE

Note: This table corresponds with HD rating. When ND is used, please choose the reactor for the next size inverter.

② Accessories

Type	Appearance	Description	Model
Remote digital operator		5 Line LCD digital operator with copy function*1	3G3AX-OP05
		Operator holder (for inside cabinet mounting)	3G3AX-OP05-H-E
		LED remote digital operator	3G3AX-OP01
		Mounting kit	4X-KITmini
LED digital operator		To be used in combination with communication option boards	3G3AX-OP03
Blind cover			3G3AX-OP05-B-E
Cables		3 m remote digital operator cable	3G3AX-CAJOP300-EE
		RJ45 to USB connection cable	USB-CONVERTERCABLE
			3G3AX-PCACN2

\*1 This digital operator is provided with the RX inverter from factory.

③ Option board

Type	Description	Function	Model
Encoder feedback	PG speed controller option card	Phase A,B and Z pulse (differential pulse) inputs (RS-422) Pulse train position command input (RS-422) Pulse monitor output (RS-422) PG frequency range: 100 kHz max	3G3AX-PG
Communication option board	DeviceNet option card	Used for running or stopping the inverter, setting or referencing parameters, and monitoring output frequency, output current... through communications with the host controller	3G3AX-RX-DRT
	PROFIBUS option card		3G3AX-RX-PRT
	EtherCAT option card		3G3AX-RX-ECT
	CompoNet option card		3G3AX-RX-CRT
	MECHATROLINK-II option card		3G3AX-RX-MRT
I/O option	Extra input/output option card	8 digital inputs, 8 digital outputs, 4 analog inputs, 1 analog output	3G3AX-EIO21-ROE

④ DC Supply with Regenerative Active Front End

Max. input power kW	Stand-alone			Kit
	Regenerative DC bus supply	Low harmonic filter	EMC filter	
30	RFE-B3 30-400-50-230-A-RVE	RHF-RA 43-400-50-20-A-RVE	RFI-RA 12-RVE	RFE-B3 30-400-50-230-IF-RVE
45	RFE-B3 45-400-50-230-A-RVE	RHF-RA 72-400-50-20-A-RVE		RFE-B3 45-400-50-230-IF-RVE
60	RFE-B3 60-400-50-230-A-RVE	RHF-RA 86-400-50-20-A-RVE	RFI-RA 23-RVE	RFE-B3 60-400-50-230-IF-RVE
80	RFE-B3 80-400-50-230-A-RVE	RHF-RA 144-400-50-20-A-RVE		RFE-B3 80-400-50-230-IF-RVE
100	RFE-B3 100-400-50-230-A-RVE		RFI-RA X5-RVE	RFE-B3 100-400-50-230-IF-RVE
125	RFE-B3 125-400-50-230-A-RVE	RHF-RA 180-400-50-20-A-RVE	RFI-RA X6-RVE	RFE-B3 125-400-50-230-IF-RVE
150	RFE-B3 150-400-50-230-A-RVE	RHF-RA 217-400-50-20-A-RVE		RFE-B3 150-400-50-230-IF-RVE
200	RFE-B3 200-400-50-230-A-RVE	RHF-RA 304-400-50-20-A-RVE		RFE-B3 200-400-50-230-IF-RVE

Note: The DC Supply with Regenerative Active Front End kit includes a Regenerative DC bus supply, low harmonic filter and EMC filter.

④ Regenerative Braking unit

Low Duty applications (50%)		High Duty applications	
Max. regenerative power kW	Regenerative braking unit	Max. regenerative power kW	Regenerative braking unit
8	RLD-E0 8-400-50-0-A-RVE	7	RHD-B0 7-400-50-0-A-RVE
12	RLD-E0 12-400-50-0-A-RVE	13	RHD-B0 13-400-50-0-A-RVE
16	RLD-E0 16-400-50-0-A-RVE	18	RHD-B0 18-400-50-0-A-RVE
20	RLD-E0 20-400-50-0-A-RVE	24	RHD-B0 24-400-50-0-A-RVE
24	RLD-E0 24-400-50-0-A-RVE	30	RHD-B0 30-400-50-230-A-RVE
32	RLD-E0 32-400-50-0-A-RVE	50	RHD-B0 50-400-50-230-A-RVE
40	RLD-E0 40-400-50-0-A-RVE	70	RHD-B0 70-400-50-230-A-RVE
48	RLD-E0 48-400-50-0-A-RVE	100	RHD-B0 100-400-50-230-A-RVE
58	RLD-E0 58-400-50-0-A-RVE	125	RHD-B0 125-400-50-230-A-RVE
80	RLD-E0 80-400-50-0-A-RVE	150	RHD-B0 150-400-50-230-A-RVE
95	RLD-E0 95-400-50-0-A-RVE		
116	RLD-E0 116-400-50-0-A-RVE		
140	RLD-E0 140-400-50-0-A-RVE		
170	RLD-E0 170-400-50-230-A-RVE		
200	RLD-E0 200-400-50-230-A-RVE		

④ Braking unit, braking resistor unit

Inverter				Braking resistor unit									
Voltage	Max. motor kW	Model 3G3RX- 3-phase	Braking unit AX- BCR_	Connectable min. resistance	Inverter mounted type (3%ED, 10 sec max)		Braking torque %	External resistor 10%ED, 10 sec max for built-in, 5 sec for braking unit		Braking torque %			
					Type AX- _	Resistance		Type AX- _	Resistance				
200 V (single-phase/ three-phase)	0.55	A2004	Built-in	50 Ω	REM00K1200-IE	200 Ω	180	REM00K1200-IE	200 Ω	180			
	1.1	A2007					100	REM00K2070-IE	70 Ω	200			
	1.5	A2015					35 Ω	REM00K4075-IE	75 Ω	140	REM00K4075-IE	75 Ω	130
	2.2	A2022		90	REM00K4035-IE	35 Ω				180			
	4.0	A2037		50	REM00K6035-IE					100			
	5.5	A2055		16 Ω	REM00K4035-IE	35 Ω	75	REM00K9020-IE	20 Ω	150			
	7.5	A2075					10 Ω	REM00K6035-IE	55	REM01K9017-IE	17 Ω	110	
	11.0	A2110							40	REM02K1017-IE		75	
	15.0	A2150		7.5 Ω	REM00K9017-IE	17 Ω	55	REM03K5010-IE	10 Ω	95			
	18.5	A2185					REM03K5010-IE	10 Ω	75	REM19K0008-IE	8 Ω	95	
	22.0	A2220							65			80	
	30.0	A2300		2035090-TE	4 Ω				REM19K0006-IE	6 Ω	80		
	37.0	A2370										60	
	45.0	A2450		2070130-TE	2.8 Ω				2 × REM19K0006-IE	3 Ω	105		
	55.0	A2550										85	
400 V (three-phase)	0.55	A4004	Built-in	100 Ω	REM00K1400-IE	400 Ω	200	REM00K1400-IE	400 Ω	200			
	1.1	A4007					200			200			
	1.5	A4015					190	REM00K2200-IE	200 Ω	190			
	2.2	A4022		REM00K2200-IE	130	REM00K5120-IE	120 Ω	200					
	4.0	A4040		70 Ω	REM00K2120-IE	120 Ω	120	REM00K6100-IE	100 Ω	140			
	5.5	A4055					REM00K4075-IE	75 Ω	140	REM00K9070-IE	70 Ω	150	
	7.5	A4075							100	REM01K9070-IE		110	
	11.0	A4110		35 Ω	REM00K6100-IE	100 Ω	50	REM02K1070-IE		75			
	15.0	A4150					24 Ω	REM00K9070-IE	70 Ω	55	REM03K5035-IE	35 Ω	110
	18.5	A4185								90	REM19K0030-IE	30 Ω	100
	22.0	A4220		20 Ω	REM03K5035-IE	35 Ω	75			85			
	30.0	A4300		4015045-TE	16 Ω				REM19K0020-IE	20 Ω	95		
	37.0	A4370		4017068-TE	11 Ω				REM38K0012-IE	15 Ω	125		
	45.0	A4450								100			
	55.0	A4550		4035090-TE	8.5 Ω				2 × REM19K0020-IE	10 Ω	100		
	75.0	B4750							3 × REM19K0030-IE		75		
	90.0	B4900		4070130-TE	5.5 Ω				2 × REM38K0012-IE	6 Ω	105		
	110.0	B411K		4090240-TE	3.2 Ω				3 × REM38K0012-IE	4 Ω	125		
132.0	B413K							4 Ω	105				

⑤ Computer software

Type	Description	Model
Computer software	Configuration and monitoring software tool	CX-Drive
		CX-One
	Software tool for energy saving calculation	€Saver

ALL DIMENSIONS SHOWN ARE IN MILLIMETERS.  
To convert millimeters into inches, multiply by 0.03937. To convert grams into ounces, multiply by 0.03527.