

High-precision Switch for Detecting Micron-unit Displacement

- Ideal for detecting and measuring wear of cutting tools or for original point of work.
- Direct input possible to microprocessors and programmable controllers.
- Types available with built-in operation indicator for ease of operation monitoring as well as a version with fiber optics remote operation indicator.
- A version with screw-type cable connector available for easy installation and maintenance.

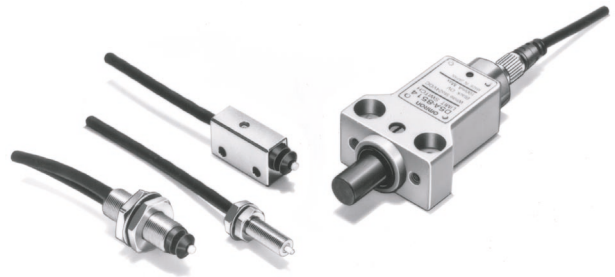

Application Examples

Origin Position Control of an X-Y Table

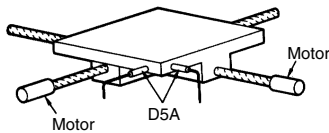

Note: Origin can be set to a desired position and the origin position can be controlled using the D5A.

Coaxiality Inspection

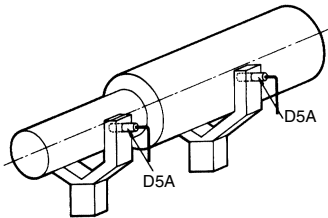

Note: The D5A can be mounted on a jig used for checking deviation to inspect its coaxiality.

Checking Turret Indexing Position

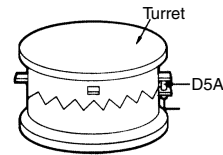

Note: Set the D5A on the turret indexing position to check if the turret is engaged properly at the specified position.



Ordering Information

■ List of Models

Contact Output Models (Without Operation Indicator)

| Actuator | Type | Repeat accuracy | Operating force | Cable lead outlet | | Degree of protection | Model | | |
|---|------|-----------------|-----------------|-------------------|--------|----------------------|----------|----------|----------|
| | | | | Type | Length | | | | |
| Pin plunger  | M5 | 1 μm max. | 0.29 N max. | Pre-wired | 1 m | IP40 | D5A-1100 | | |
| | | | 0.49 N max. | | | | D5A-1200 | | |
| | | 3 μm max. | 0.29 N max. | | | | D5A-2100 | | |
| | | | 0.49 N max. | | | | D5A-2200 | | |
| | M8 | 1 μm max. | 0.49 N max. | | | Connector | 1 m | IP67 | D5A-3200 |
| | | | 0.98 N max. | | | | | | D5A-3300 |
| | M16 | 3 μm max. | 2.45 N max. | | | | | D5A-7400 | |
| | | | | | | | | D5A-7403 | |

Solid-state Output Models (With Operation Indicator)

| Actuator | Type | Repeat accuracy | Operating force | Cable lead outlet | | Degree of protection | Model | | |
|---|-------|-----------------|-----------------|-------------------|-----------|----------------------|-------------|----------|----------|
| | | | | Type | Length | | | | |
| Pin plunger  | M8 | 1 μm max. | 0.49 N max. | Pre-wired | 1 m | IP67 | D5A-3210 | | |
| | | | 0.98 N max. | | | | D5A-3310 | | |
| | | | Slim | | | | 0.49 N max. | D5A-5210 | |
| | | | | | | | 0.98 N max. | D5A-5310 | |
| | M16 | 3 μm max. | 2.45 N max. | | | | D5A-7410 | | |
| | | | | | | | D5A-7413 | | |
| | | | | | | | Connector | D5A-8511 | |
| | | | | | | | D5A-8512 | | |
| Top plunger  | Limit | 3 μm max. | 3.92 N max. | Pre-wired | 3 m | D5A-8514 | | | |
| | | | | | 5 m | D5A-8515 | | | |
| | | | | | Connector | 3 m | D5A-9511 | | |
| | | | | | | 5 m | D5A-9512 | | |
| Bevel plunger  | | | | Limit | 3 μm max. | 3.92 N max. | Pre-wired | 3 m | D5A-9514 |
| | | | | | | | | 5 m | D5A-9515 |
| | | | | | | | Connector | 3 m | D5A-9514 |
| | | | | | | | | 5 m | D5A-9515 |

Specifications

■ Ratings

| | |
|---------------------------|--|
| Contact output models | 10 mA at 24 VAC, 10 mA at 12 VDC |
| Solid-state output models | 100 mA at 5 to 24 VDC±10% Leakage current: 0.15 mA max. Residual voltage: 3 V max. Power consumption: 3 mW max. |

■ Characteristics

| | |
|--|--|
| Degree of protection | D5A-1□, D5A-2□: IP40 Other than the above models: IP67 |
| Repeat accuracy (see note 2) | M5 (D5A-1□□□ series), M8, slim type: 1 μm max. M5 (D5A-2□□□ series), M16, limit type: 3 μm max. |
| Life expectancy (see note 3) | Mechanical: 10,000,000 operations min. Malfunction: 1,000,000 operations min. (under rated load) |
| Deviation in electrical life expectancy after 1,000,000 operations | M5, M8, M16, slim type: 10 μm max. Limit type: 20 μm max. |
| Operating speed | 1 μm to 0.5 m/s |
| Rated frequency | 50/60 Hz |
| Insulation resistance | 100 MΩ min. (at 250 VDC) between each terminal and ground |
| Contact resistance | 800 mΩ max. (initial) with 1 m cable, 2.4 Ω max. (initial) with 3 m cable, 4 Ω max. (initial) with 5 m cable) |
| Dielectric strength | 1,000 VAC, 50/60 Hz for 1 min between each terminal and ground |
| Vibration resistance | Malfunction: 10 to 55 Hz, 1.5-mm double amplitude |
| Shock resistance | Mechanical: 1,000 m/s ² min. Malfunction: 300 m/s ² min. |
| Temperature coefficient (see note 4) | M5, M8, slim type: ±20 x 10 ⁻⁶ /°C max. M16 type: ±40 x 10 ⁻⁶ /°C max. Limit type: ±50 x 10 ⁻⁶ /°C max. |
| Ambient temperature | Operating: -20°C to 75°C (with no icing) |
| Ambient humidity | Operating: 30% to 85% (30% to 95% with the seal rubber) |

- Note:**
- The above figures are initial values.
 - Contact your OMRON sales representative for measurement conditions of the repeat accuracy.
 - Life expectancy values are calculated at an operating temperature of 5°C to 35°C, and an operating humidity of 40% to 70%. Contact your OMRON sales representative for more detailed information on other operating environments.
 - The value indicates the operating position change rate for a change of 1°C in the ambient temperature.

■ Operating Characteristics

| Model | D5A-1100 D5A-2100 (see note 2) | D5A-1200 D5A-2200 (see note 2) | D5A-3200 D5A-3210 (see note 2) | D5A-3300 D5A-3310 (see note 2) | D5A-5210 (see note 2) | D5A-5310 (see note 2) |
|--------------------|--------------------------------------|--------------------------------------|--------------------------------------|--------------------------------------|--------------------------|--------------------------|
| OF max. | 0.29 N | 0.49 N | 0.49 N | 0.98 N | 0.49 N | 0.98 N |
| OT min. | 1.5 mm | 1.5 mm | 1.5 mm | 1.5 mm | 1.5 mm | 1.5 mm |
| MD max. | 5 μm | 5 μm | 5 μm | 5 μm | 5 μm | 5 μm |
| OP (see note 1) | (2 mm) | (2 mm) | (6.5 mm) | (6.5 mm) | 10.5±0.4 mm | 10.5±0.4 mm |

| Model | D5A-7400/-7410 D5A-7403/-7413 | D5A-8511/-8514 D5A-8512/-8515 | D5A-9511/-9514 D5A-9512/-9515 |
|---------|----------------------------------|----------------------------------|----------------------------------|
| OF max. | 2.45 N | 3.93 N | |
| PT max. | 1 mm | 1 mm | |
| OT min. | 2 mm | 5 mm | 4 mm |
| MD max. | 5 μm | 5 μm | 5 μm |
| OP | (4.4 mm) | 21.0±0.4 mm | 15.2±0.4 mm |
| FP | (5 mm) | (21.8 mm) | (15.8 mm) |

- Note:**
- The operating position of these types is the same as the free position because of high sensitivity (repeat accuracy: 1 μm max.).
 - Total movement is 1.9 to 2.1 mm. Set the appropriate stroke (plunging depth) to 1.0 to 1.5 mm from the FP.

Engineering Data

Repeat Accuracy Examples (Reference Data)

M5 Type (Contact Output) With Repeat Accuracy of 1 μm max.
D5A-1□□□ Series

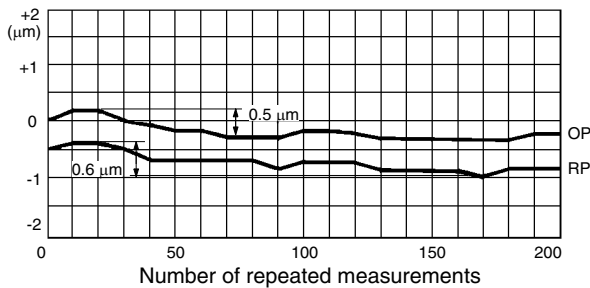

M5 Type (Contact Output) With Repeat Accuracy of 3 μm max.
D5A-2□□□ Series

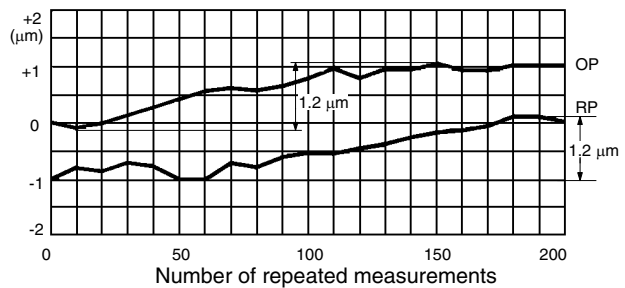

M8 Type (Contact/Solid-state Output) With Repeat Accuracy of 1 μm max.
D5A-3□□□ Series

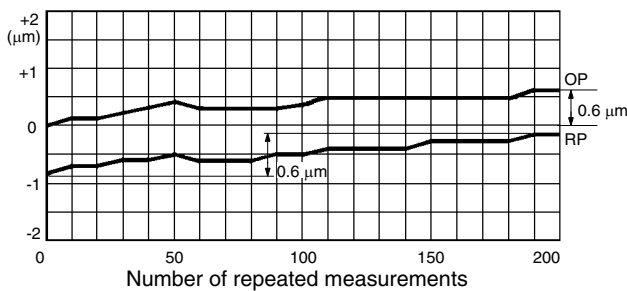

M16 Type (Contact/Solid-state Output) With Repeat Accuracy of 3 μm max.
D5A-7□□□ Series

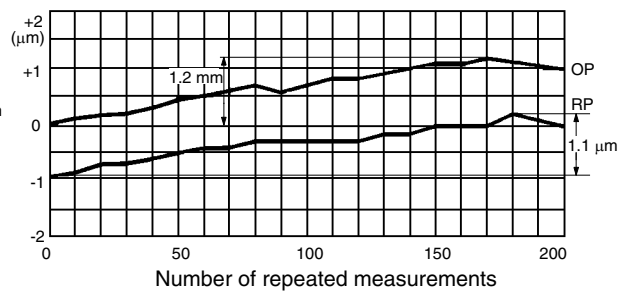

Slim Type (Solid-state Output) With Repeat Accuracy of 1 μm max.
D5A-5□□□ Series

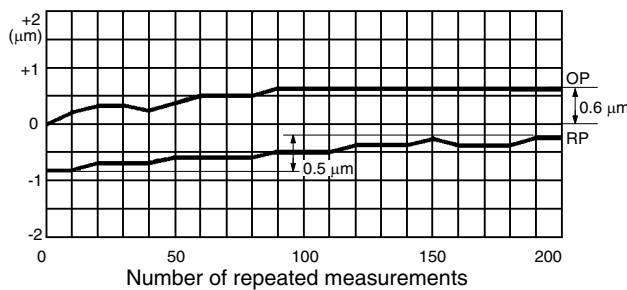

Limit Type (Solid-state Output) With Repeat Accuracy of 3 μm max.
D5A-8□□□ Series, D5A-9□□□ Series

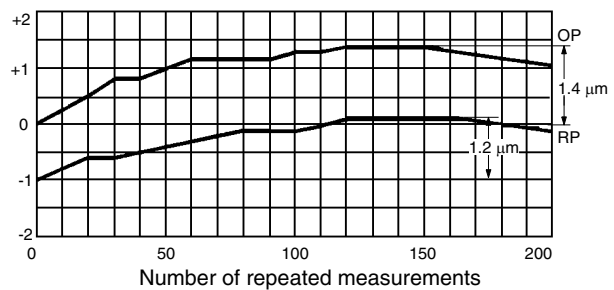

Operation

■ Contact Form/Output Circuit Diagram

Contact Output Models

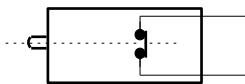

Solid-state Output Models (PNP Transistor Output)

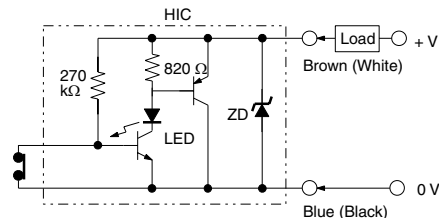

- Note:**
1. HIC (hybrid integrated circuit)
 2. An LED current limit resistor is incorporated.
 3. The ZD absorbs surge.
 4. The load can be connected to either the +V side or 0V side.

Dimensions

- Note:** 1. All units are in millimeters unless otherwise indicated.
 2. Unless otherwise specified, a tolerance of ± 0.4 mm applies to all dimensions.

**M5 Type
 (Contact Output)
 D5A-1100, D5A-2100
 D5A-1200, D5A-2200**

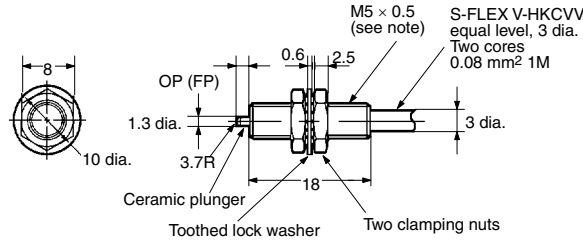
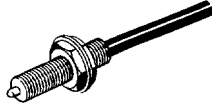

Note: The threads of the case are not standard. Therefore, standard tapping to the case is not possible for mounting.

**M8 Type
 (Solid-state Output)
 D5A-3210, D5A-3310**

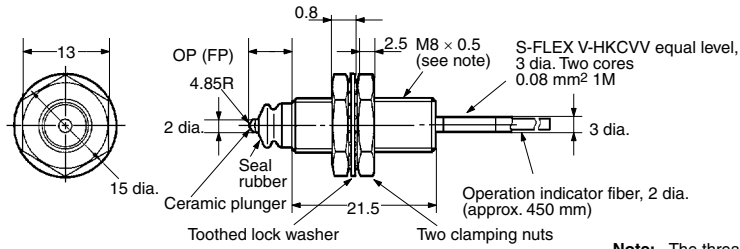
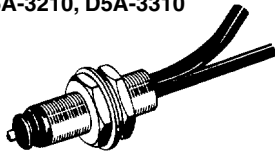

Note: The threads of the case are not standard. Therefore, standard tapping to the case is not possible for mounting.

**M8 Type
 (Contact Output)
 D5A-3200, D5A-3300**

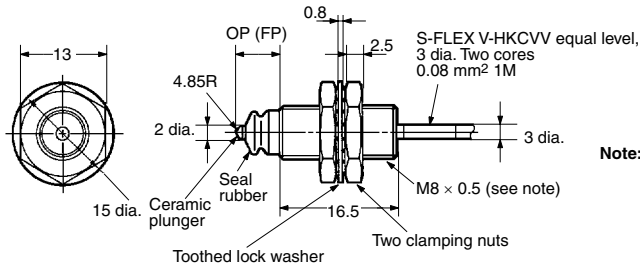
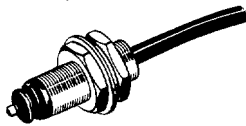

Note: The threads of the case are not standard. Therefore, standard tapping to the case is not possible for mounting.

**Slim Type
 (Solid-state Output)
 D5A-5210, D5A-5310**

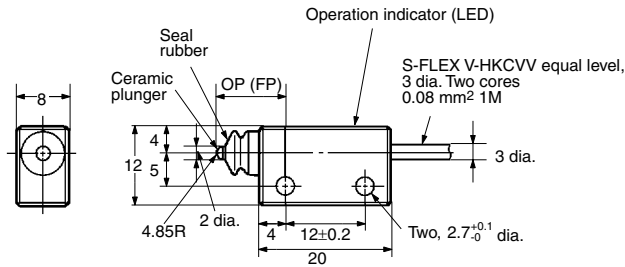
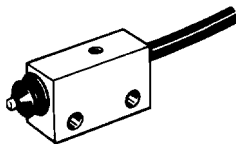

**M16 Type
(Contact Output/Solid-state Output)**
D5A-7400, D5A-7410

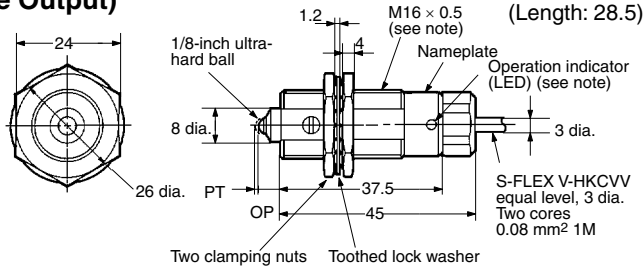
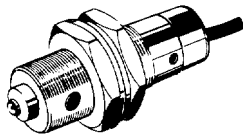

Note: Not available in the contact output type.

**M16 Type
(Contact Output/Solid-state Output)**
D5A-7403, D5A-7413
(Connector type)

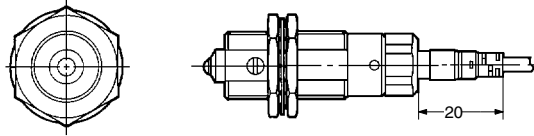
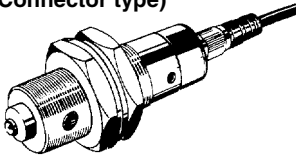

Note: The dimensions are the same as the above model's.

**Limit Type
(Solid-state Output)**
D5A-8511, D5A-8512

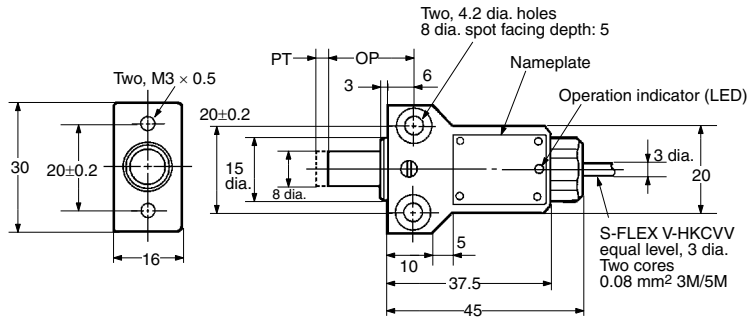
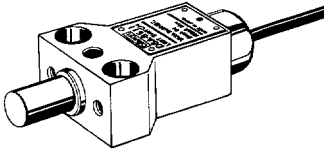

**Limit Type
(Solid-state Output)**
D5A-8514, D5A-8515
(Connector type)

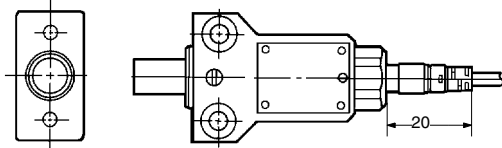
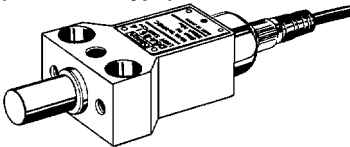

Note: The dimensions are the same as the above model's.

**Limit Type
(Solid-state Output)**
D5A-9511, D5A-9512

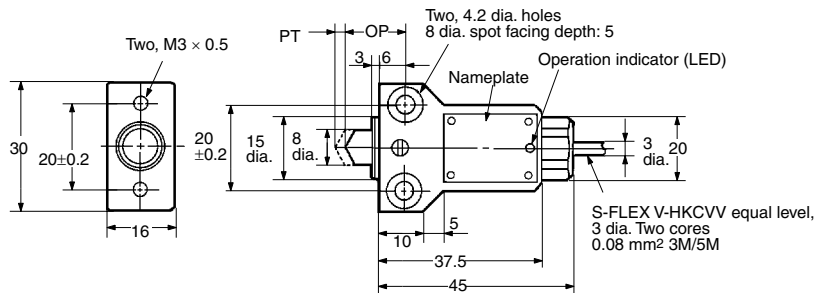
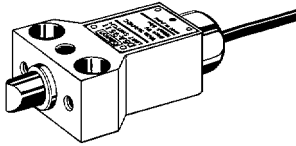

**Limit Type
(Solid-state Output)**
D5A-9514, D5A-9515
(Connector type)

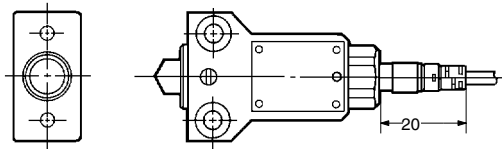
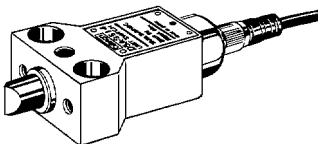

Note: The dimensions are the same as the above model's.

Precautions

■ Correct Use

Handling of Fiber Cable

Do not pull or impose any force exceeding 29.42 N on the fiber cable.

Make sure that the bending radius of the fiber cable is as large as possible and at least 25 mm.

The 40-mm portion of the fiber cable on the connector end as shown below must not be bent.

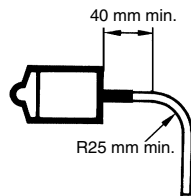

Do not impose compressing loads on the fiber cable.

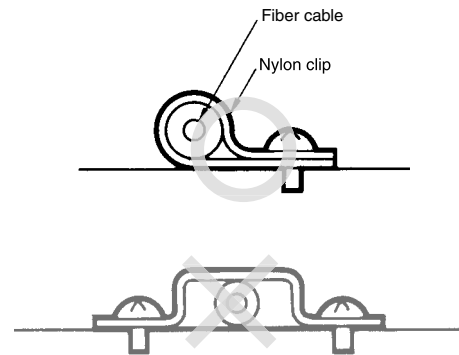

The fiber cable can be cut with OMRON's E39-F4 Cutting Tool.

Do not impose any force exceeding 29.42 N on the cord, otherwise the cord may break. Make sure that the bending radius of the cord is at least 20 mm.

Mounting

For the mounting dimensions, refer to the following figures and tables.

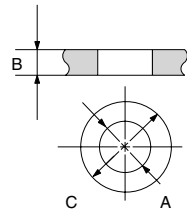

| Dimensions | | M5 | M8 | | M16 |
|------------|---------------------|-----------------|-----------------|--------------------|------------------|
| | | | Contact output | Solid-state output | |
| A | Mounting hole | 5.2±0.1 mm dia. | 8.2±0.1 mm dia. | | 16.2±0.1 mm dia. |
| B | Panel thickness | 3 to 10 mm | 5 to 8 mm | 5 to 13 mm | 10 to 17 mm |
| C | Toothed lock washer | 10 mm dia. | 15 mm dia. | | 26 mm dia. |

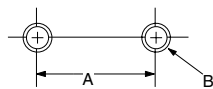

| Dimensions | | Slim | Limit |
|------------|----------------|---|---|
| A | Mounting pitch | 12±0.2 mm | 20±0.2 mm |
| B | Tapping | M2.6 | M4 |
| | Mounting hole | 2.8 ^{+0.2} ₋₀ mm dia. | 4.2 ^{+0.2} ₋₀ mm dia. |

Do not tighten the nut with too much force.

Be sure to apply the clamping torque shown in this table.

| Type | Clamping torque |
|-------|------------------------------|
| M5 | 0.98 N • m max. |
| M8 | 2.94 N • m max. |
| M16 | 9.81 N • m max. |
| Slim | 0.29 N • m max. (M2.6 screw) |
| Limit | 1.47 N • m max. (M4 screw) |

When mounting the Switch to a panel, be sure to use the toothed lock washer attached as an accessory (to M5, M8, and M16 types only). Use the washer on the panel surface opposite the object to be detected by the Switch.

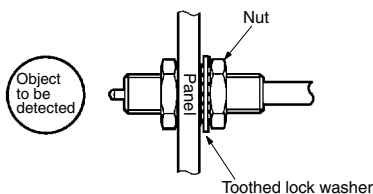

Connection of Contact Output

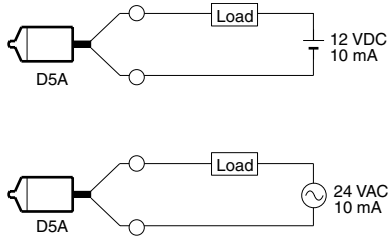

Connection of Solid-state Output

Be sure to connect the load to the power source in series.

The operating state of the Switch can be checked by the LED operation indicator (illuminants when the Switch is in operation) incorporated in the solid-state output circuit.

The output residual voltage is approximately 3 V. Therefore, exercise care when selecting the load and setting the supply voltage. The residual voltage, however, can be easily calculated because it is almost constant and is free from the influence of fluctuation in the load current.

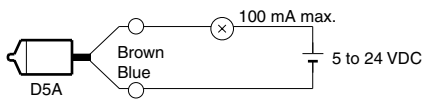

Example:

1. In the above circuit, suppose the MY relay rated at 12 VDC is used as the load. Since the must operate voltage of the relay is 80% or less than the rated voltage, it is $12 \times 0.8 = 9.6$ V. The supply voltage, in turn, is $3 + 9.6 = 12.6$ V. Therefore, the relay may not operate with a 12 V power source.
2. However, if the relay rated at 24 VDC is employed, the must operate voltage and supply voltage of the relay are respectively 19.2 V and 22.2 V. The relay therefore can operate with a 24 V power source.

When a solid-state circuit is turned OFF, leakage current of 0.15 mA (max.) flows, causing some voltages to remain in the load. For this reason, be sure to check the must release voltage of the load before using it.

Series Connection of Switches

The Solid-state Output-type Switches must not be connected in series. To obtain the same effect as a series connection, form an AND gate with a relay inserted between the Switch and load.

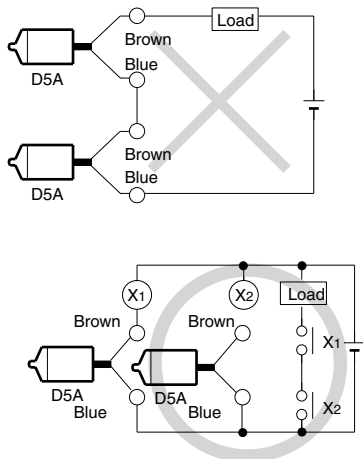

Parallel Connection of Switches

In principle, two or more D5A's should not be used in an OR configuration.

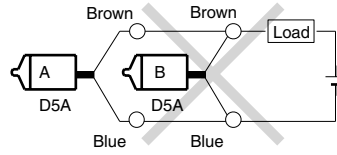

However, they can be connected in parallel provided that both switches A and B in the above figure do not operate at the same time and that the load does not have to be kept energized. In this circuit, however, the leakage current is increased, multiplied by the number of Switches connected in parallel. Consequently, the Switch may not release properly. To keep the load energized, connect a relay to each of the Switches as shown below.

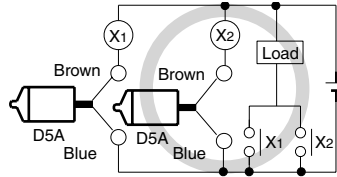

Connection to Power Source

Be sure to connect the Switch to the power source via the load. If directly connected to the power source, the internal elements of the Switch may be damaged.

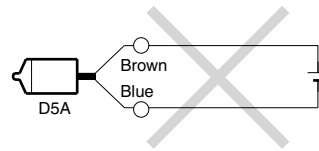

Correctly connect the white and black lead wires to the positive and negative sides, respectively, of the power source. Although the D5A will not be damaged even if the polarity is reversed by mistake, if this happens, the Switch maintains the ON state (i.e., the contact is kept open) regardless of the presence or absence of the object to be detected.

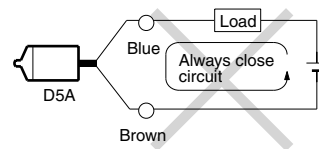

Others

Adjust the mounting of the D5A until the stroke of the pin plunger is aligned with the stroke of the operating body. Special attention should be paid to the ceramic pushbutton unit. It might be damaged if undue shock is applied.



The harder the material for the dog and the more solidly the mounting base is fitted, the more accurately a minute displacement is detected.

When a limit switch type is used, apply grease to the dog to reduce friction between it and the plunger. Do not apply grease to pin plungers, otherwise the grease may stick to the contacts or generate gas that may cause contact failures.

Be sure to use dogs made of hard materials for bevel or top plungers and apply grease to the surface of the dogs. The hardness (Hv) of a bevel plunger is 2,000 or over, for which it is recommended that a dog that has an Hv value of 1,000 or less be used.

Do not fail to provide a stopper so as to prevent the enclosure of the D5A from being used as the stoppers.

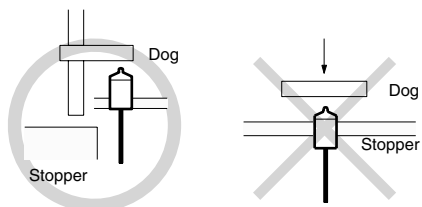

Attach an appropriate cover for the protection of the D5A from machining oil or cuttings. No protective cover is, however, provided together with the Switch.

Exercise care that excessive force is not applied to the ceramic plunger of M5, M8, or slim type.

If the possibility exists that strong shock may be applied to the plunger when the Switch is being mounted, use a protective cap. The plunger may not release if it is depressed with too great a force. Set its stroke by referring to the OT value indicated in *Operating Characteristics*.

M5, M8



Slim

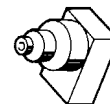

Do not mount the Switch with its nameplate facing downwards (i.e., in the direction of gravity), otherwise the oil drain hole will not work effectively.

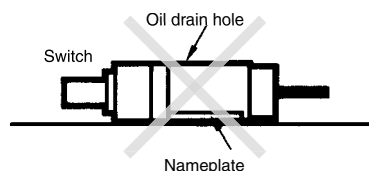

ALL DIMENSIONS SHOWN ARE IN MILLIMETERS.

To convert millimeters into inches, multiply by 0.03937. To convert grams into ounces, multiply by 0.03527.