

MCLA1608V1

Automotive multilayer chip inductor



Product features

- AEC-Q200 qualified
- 0603 (1608 metric) package
- Multilayer monolithic construction yields high reliability
- Inductance range from 0.047 uH to 3.9 uH
- Moisture sensitivity level (MSL): 1

Applications

- ADAS
- Infotainment
- Wireless communications
- Wifi, bluetooth, satellite
- Antenna tuning
- On board computer

Environmental data

- Operating temperature range: -40 °C to +125 °C (ambient plus self-temperature rise)



Product specifications

Part number	OCL Tolerance (%)	OCL (μH)	Q minimum	DCR@ (Ω) @ +25 °C maximum	Test frequency (MHz)	Test voltage (mV)	SRF (MHz) minimum	I Rated (mA)
MCLA1608V1-R047-R	±10	0.047	15	0.2	50	50	260	50
MCLA1608V1-R056-R	±10	0.056	15	0.2	50	50	260	50
MCLA1608V1-R068-R	±10	0.068	15	0.2	50	50	250	50
MCLA1608V1-R082-R	±10	0.082	15	0.2	50	50	245	50
MCLA1608V1-R100-R	±10	0.10	20	0.25	25	50	240	50
MCLA1608V1-R120-R	±10	0.12	20	0.3	25	50	205	50
MCLA1608V1-R150-R	±10	0.15	20	0.3	25	50	180	50
MCLA1608V1-R180-R	±10	0.18	20	0.3	25	50	165	50
MCLA1608V1-R220-R	±10	0.22	20	0.4	25	50	150	50
MCLA1608V1-R270-R	±10	0.27	20	0.45	25	50	136	50
MCLA1608V1-R330-R	±10	0.33	20	0.5	25	50	125	50
MCLA1608V1-R390-R	±10	0.39	20	0.6	25	50	110	50
MCLA1608V1-R470-R	±10	0.47	20	0.7	25	50	105	50
MCLA1608V1-R560-R	±10	0.56	20	0.7	25	50	95	50
MCLA1608V1-R680-R	±10	0.68	20	0.9	25	50	90	50
MCLA1608V1-R820-R	±10	0.82	20	1.0	25	50	85	50
MCLA1608V1-1R0-R	±10	1.0	25	0.5	10	50	75	25
MCLA1608V1-1R2-R	±10	1.2	25	0.55	10	50	65	25
MCLA1608V1-1R5-R	±10	1.5	25	0.7	10	50	60	25
MCLA1608V1-1R8-R	±10	1.8	25	0.75	10	50	55	25
MCLA1608V1-2R2-R	±10	2.2	25	0.8	10	50	50	25
MCLA1608V1-2R7-R	±10	2.7	25	0.9	10	50	45	15
MCLA1608V1-3R3-R	±10	3.3	25	1.0	10	50	40	15
MCLA1608V1-3R9-R	±10	3.9	25	1.3	10	50	35	15

1. Test frequency and voltage is for open circuit inductance (OCL) and Q at +25 °C
2. Rated I: When rated I is applied to the product, self-temperature rise will be 40 °C or less.

3. Part Number Definition: MCLA1608V1-xxx-R
MCLA1608V1 = Product code and size
xxx= inductance value in μH, R= decimal point,
If no R is present then last character equals number of zeros
-R suffix = RoHS compliant

Mechanical parameters, schematic, pad layout (mm)

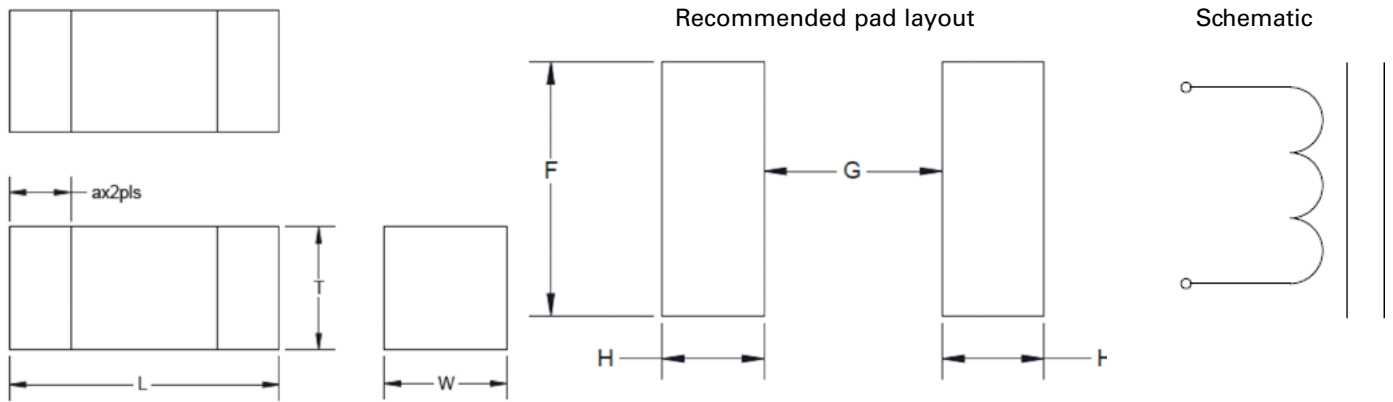

Part Number	L	W	T	a	F	G	H
MCLA1608V1-xxx-R	1.60±0.20	0.80±0.20	0.80±0.20	0.30±0.20	1.20 ref	0.40 ref	0.90 ref

Part marking: No marking
 All soldering surfaces to be coplanar within 0.1 millimeters
 Tolerances are ±0.1 millimeters unless stated otherwise
 Pad layout dimensions are reference only
 Traces or vias underneath the inductor is not recommended

Packaging information (mm)

Drawing not to scale
 Supplied in tape and reel packaging, 4000 parts per 7" diameter reel

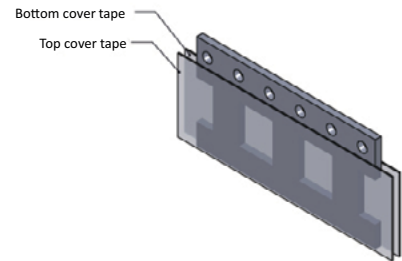
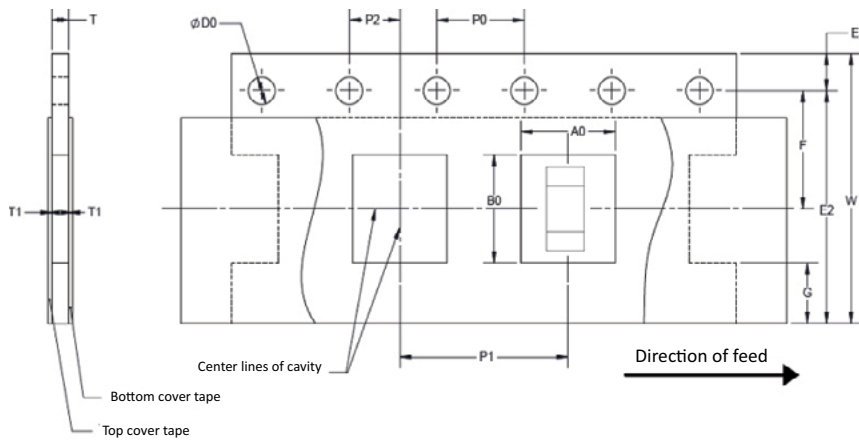

W±0.2	8.00
F±0.1	3.50
E1±0.2	1.75
E2 Min	na
P0±0.2	4.00
P1±0.2	4.00
P2±0.1	2.00
D0±0.1	1.55
A0	1.1±0.2
B0	1.9±0.2
T	0.95±0.1
T1 Max	na

Inductance vs frequency

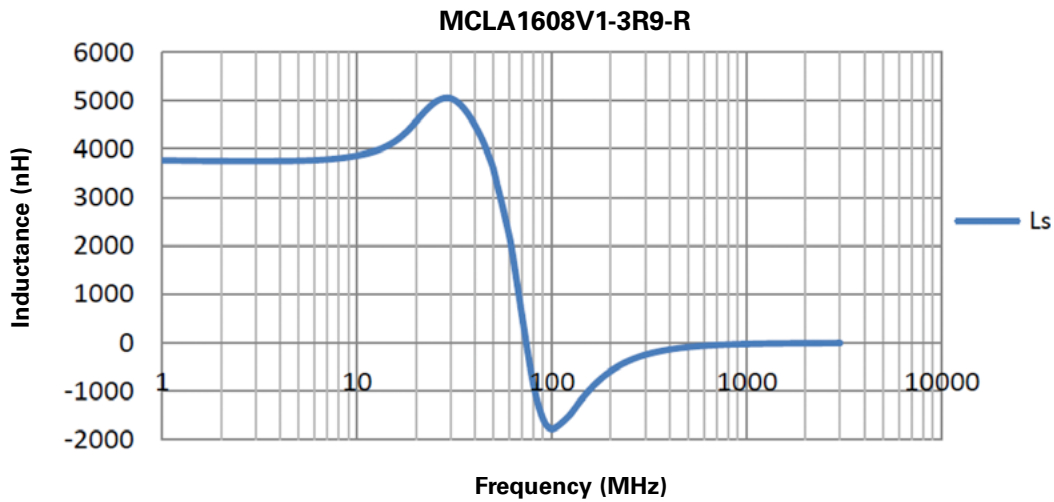
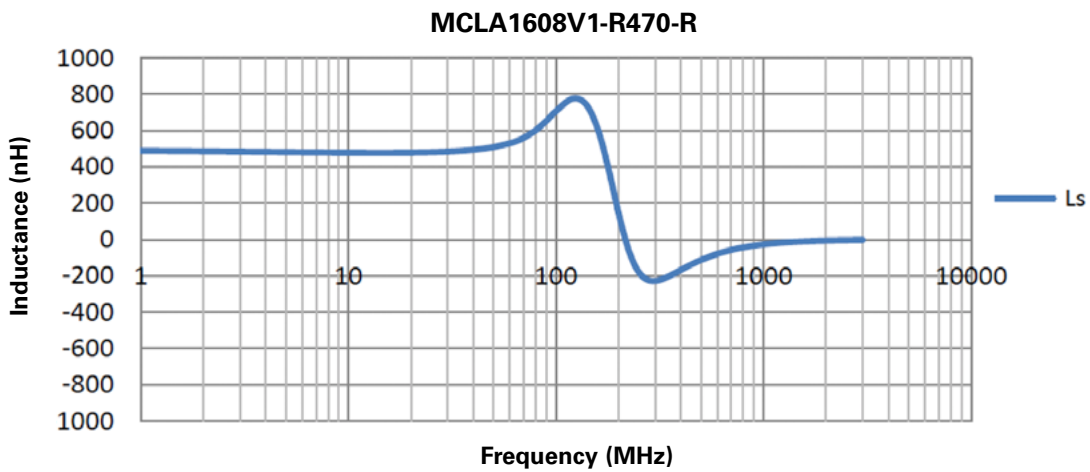
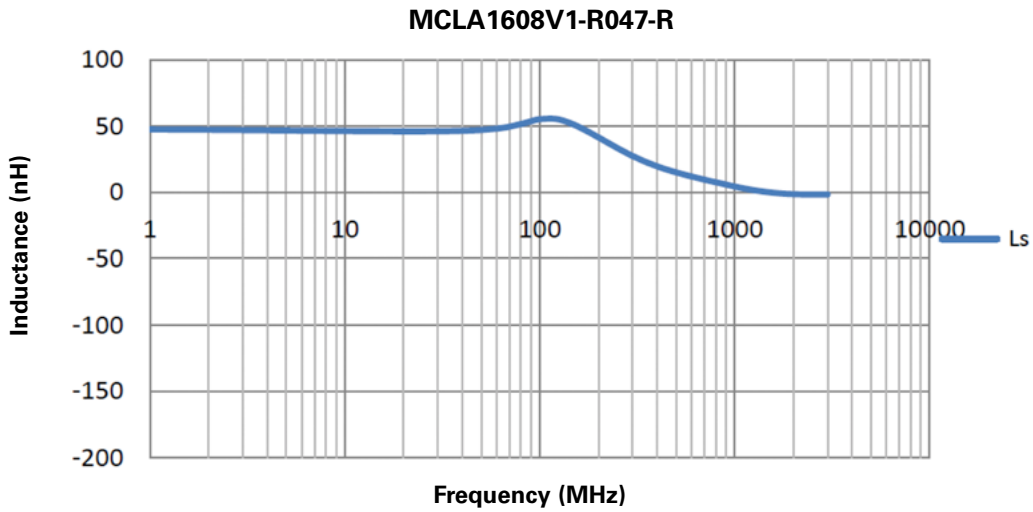

Q vs frequency

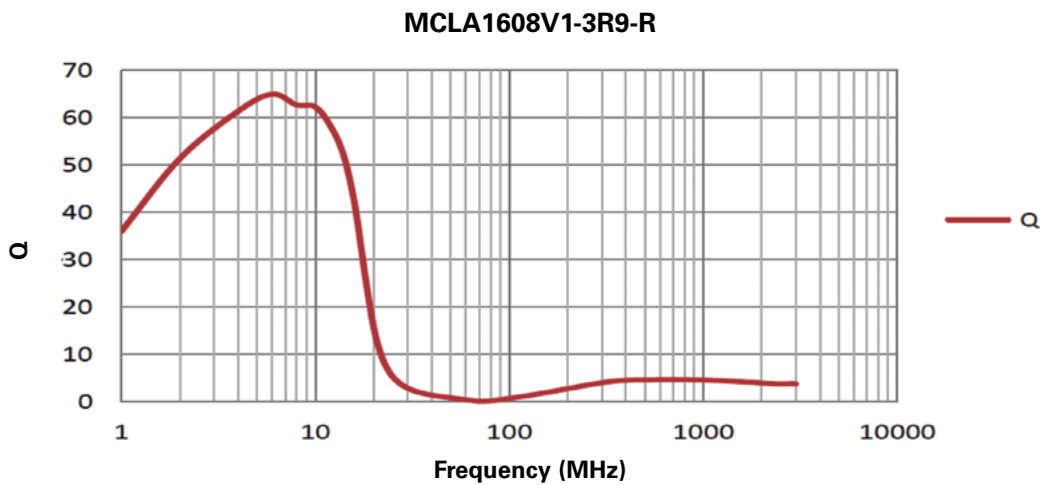
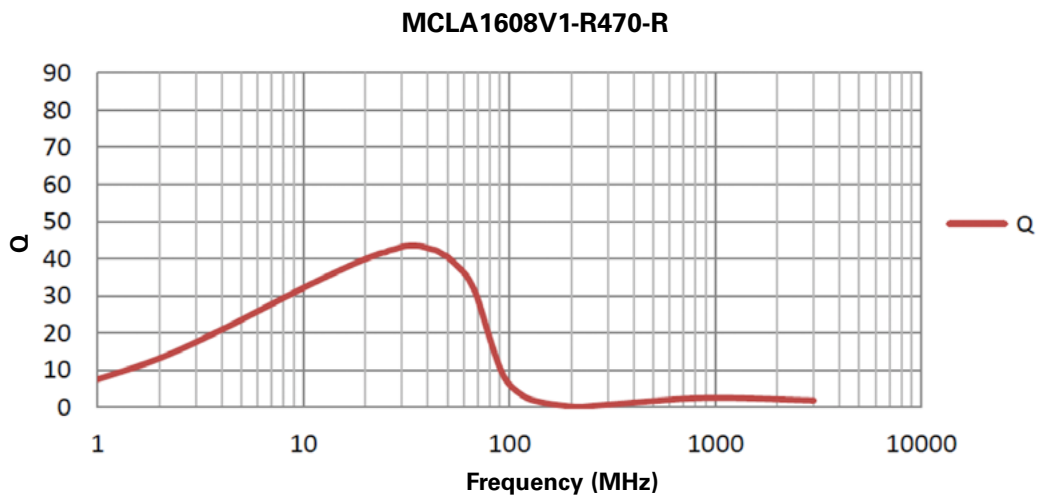
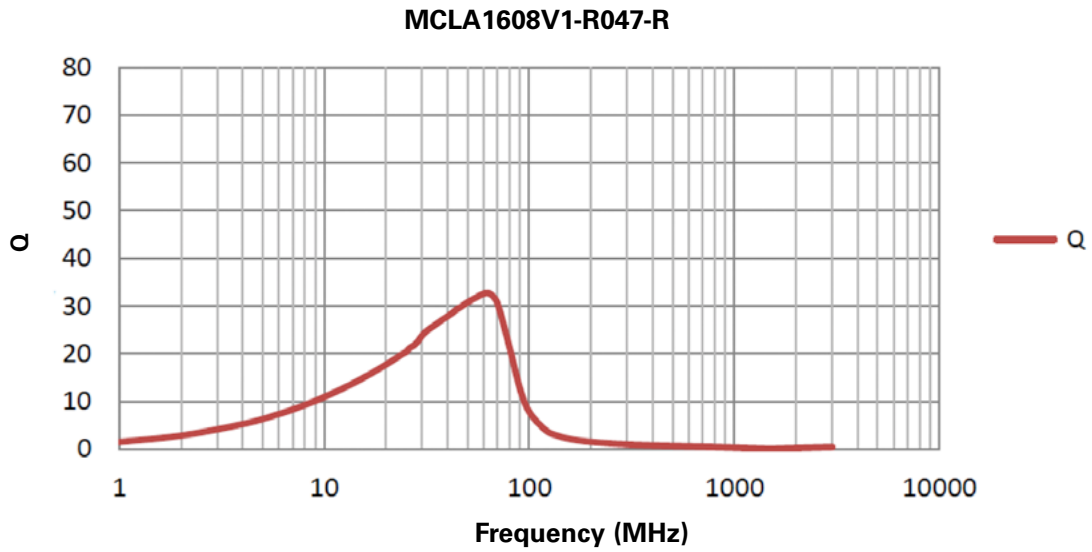

Solder reflow profile

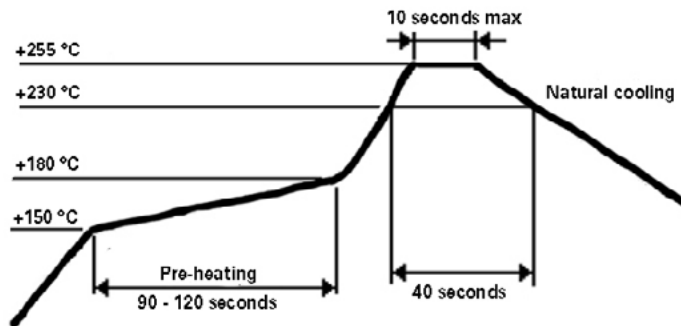

Life Support Policy: Eaton does not authorize the use of any of its products for use in life support devices or systems without the express written approval of an officer of the Company. Life support systems are devices which support or sustain life, and whose failure to perform, when properly used in accordance with instructions for use provided in the labeling, can be reasonably expected to result in significant injury to the user.

Eaton reserves the right, without notice, to change design or construction of any products and to discontinue or limit distribution of any products. Eaton also reserves the right to change or update, without notice, any technical information contained in this bulletin.

Eaton
Electronics Division
1000 Eaton Boulevard
Cleveland, OH 44122
United States
Eaton.com/electronics

© 2019 Eaton
All Rights Reserved
Printed in USA
Publication No. 10975 BU-MC19103
November 2019

Eaton is a registered trademark.

All other trademarks are property
of their respective owners.

Follow us on social media to get the
latest product and support information.

