

Contents

Description	Page
1. Product overview	
Hydraulic Magnetic Principle	6
Hydraulic Magnetic Tripping Mechanism	7
JS Product variations	9
2. Product Configuration Charts	
How to order	10
3. Accessories	
Boots	12
Push-on screw terminals	12
Blanking plate	12
Adapter	13
JAS Cap	13
4. Technical specifications	
Technical characteristics	14
Approvals	15
Internal circuits	16
Time delay curve selection	19
5. Overall dimensions	
JAS type	28
JBS type	29
JCS type	30
JES 3/8-32 type	31
JES 1/2-32 type	32
MID-TRIP/Alarm-Switch	33
Terminal dimensions and location	34
Auxiliary contacts	36

Remark: After use of circuit breaker, the unit must be discarded in accordance with local regulations.

The technical information published in this handbook is subject to change without prior notice. Modifications may occur as part of continual improvement of our products.

Heinemann is a registered trademark.

1 Hydraulic Magnetic Technology Advantages



Extreme temperature protection from -40°C to $+85^{\circ}\text{C}$

- Constant trip rating from -40°C to $+85^{\circ}\text{C}$
- Protects both cables and equipment across full temperature range
- No costly over-sizing of breakers or cabling in high temperature environments
- No protection reduction in low temperature environments
- No nuisance tripping in high ambient conditions

Robust design

- Applied on rail, industrial, telecom, military and marine applications

Minimal voltage drop

- Low internal resistance
- Especially needed with low voltage DC applications

Avoid nuisance tripping

- Shock resistant

Harsh environment protection

- Resistant to high humidity and saline environments

Integrated auxiliary alarm switch

- No need for extra poles to accommodate the auxiliary switch – saves horizontal space and cost

Breaker Description

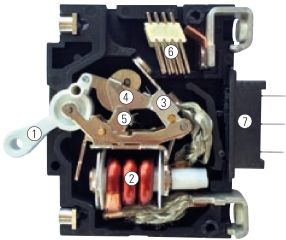

- 1 The handle has two positions ON and OFF providing a clear visual indication of the breaker condition. MID-TRIP breaker version provides an electrical trip condition indication.
- 2 Tripping of all Heinemann® hydraulic magnetic circuit breakers is caused by excess current through the solenoid coil. This is designed for the rated current and is not influenced by the ambient temperature.
- 3 For each make or break operation the moving contact arm slides across the lower contact area, thus creating a wiping action which guarantees low contact resistance resulting in prolonged life.
- 4 The armature is completely balanced, thus preventing switching off under severe shock or vibration conditions.
- 5 The switch mechanism is simple and robust. Designed 'trip free' so that it is impossible to hold on to the switch against an existing short-circuit condition.
- 6 The arc produced by the switch operation is broken down into a number of smaller arcs by the special shape of the contacts and the extinguishing grids, and is blown out by the magnetic field generated.
- 7 Breakers can also be supplied with auxiliary contacts or remote breaker trip Ducon devices.

Note:

Image does not represent the JS series.

Hydraulic Magnetic Tripping Mechanism

Normal Operation

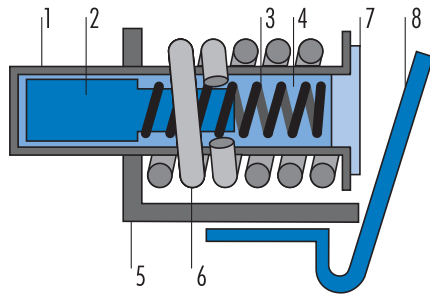

The load current is at or below the nominal rating of the breaker. The core remains at the (left) end of the tube opposite the armature.

- 1. Tube 2. Core 3. Spring 4. Fluid 5. Frame
- 6. Coil (sensor) 7. Pole piece 8. Armature

Moderate Overload Condition

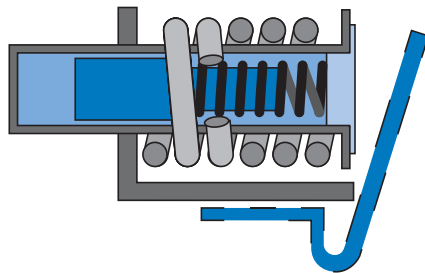

The current is sufficient to create enough magnetic flux to move the core (to the right) compressing the springs slightly.

Overload Condition

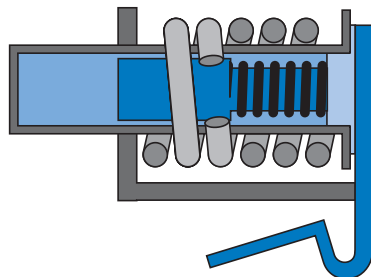

The magnetic flux is sufficient to move the core completely to the end of the tube (right) which attracts the armature, and trips the breaker.

Short-Circuit Condition

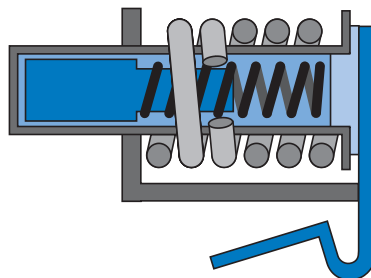

The flux produced by the coil alone, regardless of the core position, is sufficient to attract the armature causing the breaker to trip. This circuit interruption occurs with no intentional delay.

JAS

Front mounting

**JAS** circuit breakers are designed for front mounting.

Two inserts are available for screws with M3 or 6/32 threads.

Cutouts are circular (for any thickness of panels between 1-3 mm).

Panel cutouts depends on number of poles.

JAS circuit breakers are available in 1, 2, 3 or 4 pole execution

The front mounting screws are not delivered with the breakers, as it depend on the panel thickness.

1

JBS

Snap-in mount breakers

**JBS** circuit breakers are identical to JAS type except for the method of mounting. The special spring-clip face-plate allows a snap-in function without need of screws or tools.

Cutouts are rectangular (for any thickness of panels between 1-3 mm).

Panel cutouts depends on number of poles.

JBS circuit breakers are available in 1, 2, 3 or 4 pole execution, with handle on each pole. Handle protection against nuisance tripping also available in code definition.

This type of circuit breaker is not available with internal circuits 53, 62, 63, 66, 88.

JBS dummy frontal plates are available, to be fitted on cutouts larger than MCBs. Ordering part No. 20808.

JCS

Rocker-handle breakers

**JCS** circuit breakers are available with rocker-handles in white or black.

JCS circuit breakers are designed for front mounting.

Threads with M3 or 6-32.

JCS circuit breakers are available in 1, 2, 3 or 4 pole execution.

Handle protection against nuisance tripping also available in code definition.

The front mounting screws are not delivered with the breakers, as it depend on the panel thickness.

JES

Sealed front mounting – IP65

**JES** circuit breakers are well suited for use where protection against water spray and splash is needed.

JES circuit breakers are designed for central front mounting.

Threads with 3/8-32 or 1/2-32 UNC.

A moulded-in-place silicon rubber surrounding the bat-type metal handle effectively prevents water entry.

The panel cutout itself is sealed by a captive O-ring at the base of the breaker's threaded gland bushing.

JES breakers are easy to fit. A lock washer and the captive O-ring provide a firm pressure-tight fit when the hex nut is tightened.

JES circuit breakers are available in 1, 2 or 3 pole execution (one handle only).

Product Configuration Chart

Select the product attribute **codes** required to configure the Eaton catalog number.

2 The proposed example is a 2 poles circuit breaker with two toggles, alarm-switch with test, front mounting version to be fitted with 4 screws M3.

The pole left-hand side front view has an auxiliary contact with 2.8 mm quick connect terminals.

Each pole 5 Amps In with medium delay curve, 8 x In high-inrush = 40 Amps during 10 ms.

The electrical connection is designed for quick-on connectors. This selected type of circuit breaker is UL-CSA approved at 80V DC.

J A B 2 S - B 2 B 3 - L I -

Breaker Type		Options				Number of poles	
		Alarm-switch		Mid-trip			
		Without test	With test	Without test	With test		
Toggle	A	A	B	M	N	1 (Front view from left to right) poles	
Snap-in mount	B	A	B	M	N	3 or 4 poles	
Rocker handle	C*	-	-	-	-	Type E: max. 3 poles	
Sealed front	E	-	-	-	-		

*Refer to page 31 for handle positions availability.

	Frequency and terminals			
	Fast-on	Screws M4	Screws M5	
50/60 Hz	A** P*	K	T	
DC	B** Q*	L	V	
400 Hz	C** S*	N	W	
50/60 Hz/DC	D** -	M	R	

* Special traction codes including ampere rating engraved on handle.

** Codes also available for JAS types for printed circuit boards.

	Internal circuits					
	10 x In		18 x In		25 x In	
	8 x In		15 x In		22 x In	
Auxiliary Contact	Without	With	Without	With	Without	With
Switch only (without coil)	0	12	-	-	-	-
Series trip	3	2	8	9	38	39
Shunt trip	5	-	22	-	32	-
Relay trip	6*	62*	23*	-	33*	-
Dual rating	7	-	27	-	37	-
DUCON	15	53	25	-	-	-
DUCON (separate coil) series and relay	16	63	26	-	-	-
DUCON relay and relay	66	-	-	-	-	-
Relay coil	86	88	76	-	96	-
Auxiliary contact only	-	82	-	-	-	-

* If this kind of protection has to meet IEC 950 requirements the circuit breaker must be ordered with 2 poles.

* Dielectric strength of 2 x Un + 1000 V.

Handle number / position – front view from left to right	
Single pole	A
2 poles, 1 handle on left pole	B
2 poles, 1 handle on right pole	C
3 poles, 1 handle on centre pole	D
Handle on every pole, handle spacers as kit	E
4 poles, 2 handles on centre poles, handle spacers as kit	J
Handle on every pole, handle spacers mounted	L
3 poles, 1 handle on centre pole + 1 handle on left pole, handle spacers mounted	M
3 poles, 1 handle on centre pole + 1 handle on right pole, handle spacers mounted	N
4 poles, 2 handles on centre poles, handle spacers mounted	R
Single pole and short handle (JAS and JBS only)	S
3 poles, 1 handle on left pole	U
3 poles, 1 handle on right pole	W

Handle color and marking						
Type	Color	Type	ON/OFF	I/O	I/ON I/OFF	Without
JAS	Black	JCS	A	I*	C	R
JBS	White		B	J	K	S
JES	Metal 3/8		B**	J**	-	-
	Metal 1/2		-	-	-	S

* Standard version black engraving I/O

** Marking on indicating plate

..... 04 - D - A - 52 - 5 - 2

Voltage or current rating V or A		
1	Serie Circuits	In - Curve / Voltage * NB: for switch only, no curve.
2	DuCon Circuits	In - Curve - VxxxP xxx = Volt coil nominal voltage.
3	Relay Circuits	VxxxP xxx = Volt Coil
4	Dual-Rating	In1/In2 - Curve

* Voltage is noted only when it differs from the standard voltage.

Time delay curves – see pages 19-27

Auxiliary contacts					
			I max. (A) at 220 V AC		
Function	Contact	Terminals	UL/CSA	VDE	Code
NO-NC	Ag	4,8 [0.187] fast-on	10.1	–	07
NO-NC inv.	Ag	for printed circuit board (left)	5.0	1.0	40
NO-NC	Ag	for printed circuit board (right)	5.0	1.0	41
NO-NC	Ag	2,8 [0.187] fast-on	10.1	1.0	52*
NO-NC	Ag	Solder terminals	10.1	1.0	53
NO-NC	AgAuPt	2,8 [0.110] fast-on	0.1	0.1	54
NO-NC – Protected	Ag	2,8 [0.110] fast-on	10.1	1.0	44
NO-NC – Protected	AgAuPt	2,8 [0.110] fast-on	0.1	0.1	45
NO-NC – Dual protected	Ag	2,8 [0.110] fast-on	10.1	1.0	46
NO-NC – Dual protected	AgAuPt	2,8 [0.110] fast-on	0.1	0.1	47

Note
mm [inches].
* 52: standard.

UL-CSA approvals (authorised limits see page 15)	
Up to : 250 V 50/60 Hz - 240 V 400 Hz - 80 VDC	A (UL 1077)
Up to : 250 V 50/60 Hz - 240 V 400 Hz - 80 V DC , without UL-CSA approval	NU
Up to : 277 V 50/60 Hz	L (UL 1077)
Up to : 277 V 50/60 Hz, without UL-CSA approval	NL
Up to : 415 V 50/60 Hz, only with 3 poles minimum	AD (UL 1077)
Up to : 415 V 50/60 Hz, without UL-CSA approval	ND
Up to : 80 V DC	DU (UL 489 A listed)

VDE approval (authorized limits see page 15)	
Without VDE approval – standard	D
DIN EN 60947-2	H*
DIN EN 60934	K
Without VDE approval, but in conformity with IEC 60950	W

* Only internal circuit codes 0, 2, 3, 5, 8, 9, 12, 15, 16, 22, 25, 26, 32, 38, 39, 53 and 86.

Mounting inserts + other mount and terminals	
01	Types JAS/JCS, 6-32 UNC inserts, front mounting. JCS : without rocker handle guard
04	Type JAS, M3 inserts, front mounting
04	Type JCS, M3 inserts, front mounting, without rocker handle guard
05	Type JCS, M3 inserts, front mounting, with rocker handle guard
06	Type JCS, 6-32 inserts, front mounting, with rocker handle guard
11	Type JES, central 3/8-32 UNC thread mounting with indicating plate
18	Type JBS, front plate 19,05 mm marked ON/OFF, snap-in mount, handle with guard (1 pole only)
19	Type JBS, front plate 19,05 mm marked ON/OFF, snap-in mount, handle without guard
20	Type JBS, front plate 19,05 mm marked I/O, snap-in mount, handle with guard (1 pole only)
21	Type JBS, front plate 19,05 mm marked I/O, snap-in mount, handle without guard
22	Type JES, central 1/2-32 UNC thread mounting without indicating plate
DN	DIN-RAIL mount. (Switch and serie trip only, without auxiliary switch)
50	Type JAS for printed circuit boards, outlet of terminals to the left, circuit breaker front view (Standard)
51	Type JAS for printed circuit boards, outlet of terminals to the right, circuit breaker front view

Related Products

Accessories

Boots (IP 65)

This Silicone rubber boot ensures a perfect water-tight front face.

Boots are delivered with 6-32 UNC screw.

Part Number

JA1S	K25108LL
JA2S	K25109LL
JA3S	K25110LL

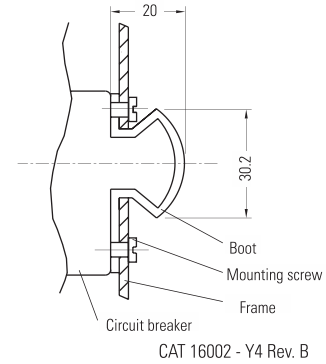

Push-on screw terminals

The push-on screw terminals of JS, are available with :

Part Number

10-32	K02819LL
-------	----------

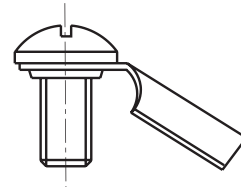

CAT 17902 - Y4

Blanking plate

Part Number

K20808LL

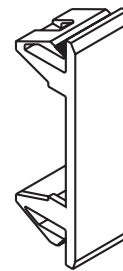

CAT 17702 - Y4

JAS Cap

This JS Cap is used to hide the aperture when not in use.

- Material: Polyethylene
- Cut-out dimension: \varnothing 15.9 mm same as for JS breaker.

Part Number

K20855LL

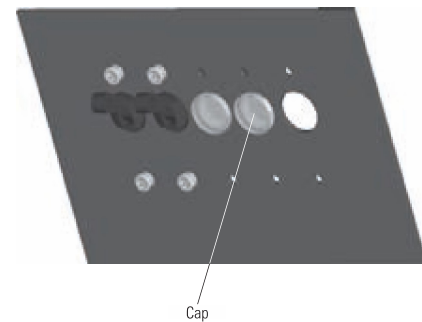

The Remote Breaker Reset (RBR) allows user to remotely reset a circuit breaker after it has been opened. The RBR is designed to work with Eaton Heinemann JS series Breakers for application that require remote circuit breaker control.

Thanks to its mounting directly under the circuit breaker handle, the RBR saves valuable horizontal space and allows fast and reliable closing of the protected circuit once fault has been cleared.

The speed of actuation also resolves timing issues compared to other

solutions available on the market and avoids arcing during reset under overload or short circuit conditions

RBR devices are available in 4 voltage ratings and two sizes, depending on application and number of poles to reset.

3

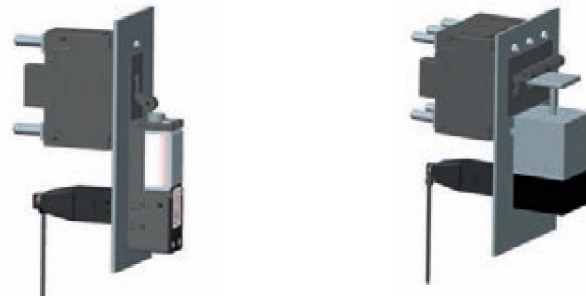

Series	ARJS	AR
Maximum number of poles to reset	1 pole AR or JS	up to 4 poles AR or JS
Electrical characteristics		
Operating voltage	24-48-72-110 VDC	
Type of signal	Pulse	
Operating conditions, standards and approvals		
Operating temperature	-40°C to +55°C (-40°F to +131°F)	
Approvals - Rail	EN 50155, NFF 61373, NFF 16102, VDC0580, NFC79300	
Testing	10'000 Cycles (2 cycles per minute)	
Physical characteristics		
Dimensions WxHxD (mm)	19x 60x 20 mm	35 x 57 x 35 mm
Dimensions WxHxD (inches)	0.75" x 2.36" x 0.79"	1.38" x 2.25" x 1.38"
Weight	65 grams (2.29 oz)	300 g (10.6 oz)
Mounting, Terminals		
Power Connection	SMS 3 pin	SMS 3pin / Hirschmann 4 faston
Mounting plate thickness	2 to 5mm (0.079" to 0.197")	

Note: Technical information may differ by product variation, please contact your Eaton representative for more detailed information. In the interests of continual product improvement all specifications are subject to change without notice.

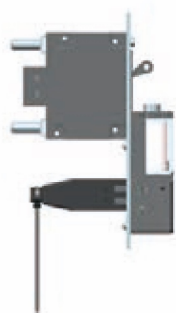

Circuit Breaker closed (protected circuit is powered)



Circuit Breaker opens (current is cut in the protected circuit)

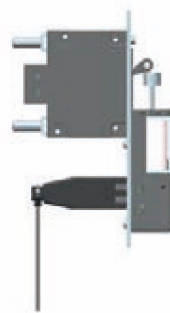

Signal pulse sent to RBR for reset instruction: RBR actuates the Circuit Breakers handle



RBR returns to initial configuration (by gravity)

Technical characteristics

Operating Temperature	-40°C +85°C	
Storage Temperature	-40°C +85°C	
Humidity	IEC 60068-2-78 and MIL - STD - 202 Method 103 Test A	
Protection	IEC 60529 IP 00 Back terminals sealing IP 40 Front sealing IP 65 JES Handle	
Shock	IEC 60068-2-27 MIL - STD - 202*, method 213 cond1 100 G, 6 ms	
Vibration	IEC 60068-2-6 MIL - STD - 202*, method 204 10 to 500 Hz 10 G amplitude 1.52 mm	
Vibrations (Rail)	IEC 61373 Cat. 1 Classe B	
Life	10 000 switching operations 6000 at rated current 4000 at no load	
Approx. weights (JAS Type)	1 pole	65 g = 0.143 lbs
	2 poles	140 g = 0.309 lbs
	3 poles	210 g = 0.463 lbs
	4 poles	280 g = 0.617 lbs
Approvals	UL - CSA and VDE, CC and GOST. In conformity with IEC 60950	
Rail Approvals	NF F 16-101 & NF F 16-102 (A1) Fire & Smoke test NF F 62-001 Rolling Stock NF EN60068-2-1 cold test NF EN60068-2-2 dry heat test NF F60068-2-1 Salt spray 500h IEC 61373 vibrations IEC 45545-2 Fire & Smoke Up to 90 VDC and 430 AC	
Dielectric strength	3750 V AC 50/60 Hz during 1 minute	
Insulation resistance	100 MΩ under 500 V DC	
Auxiliary switches	220 V AC : 10 A	
Rated current	24 V DC : 8 A (resistive) 220 V AC : 0,1 A (contact AgAuPt)	
Time delay	Wide range available, see pages 19-27	

Resistance and impedance values

CAT - 1202 - Y4 Rev. B

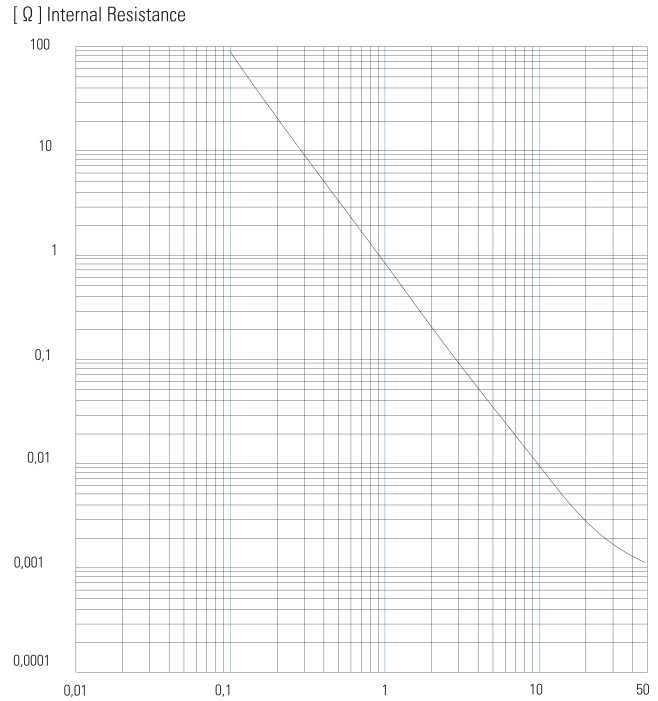

Tolerance limits of internal resistance

Current (A)	Tolerances (%)
0.01 to 19.9	±25
20 to 50	±35

The time delay vs temperature derating curve

This curve allows to define the time derating simply multiply the time delay at ambient temperature by the value provided by the curve in %.

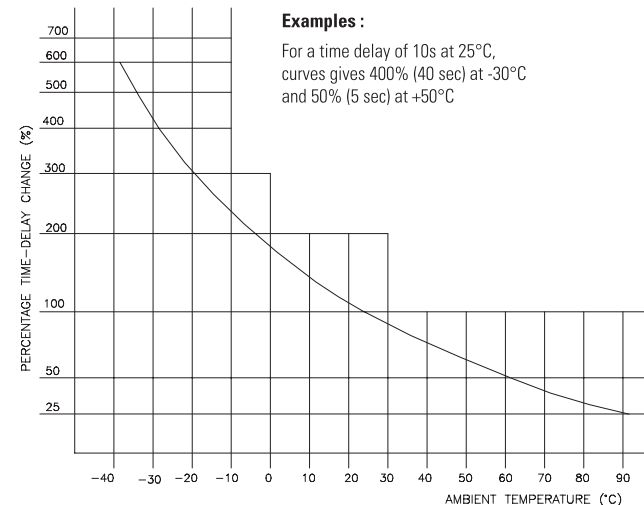

Approvals VDE-UL-CSA

	Type	Nb. poles	Rating operating voltage Ue		Rating current In	Interrupting capacity
DIN EN 60934	JA.S - JB.S - JC.S - JE.S	1	250 V	50/60 Hz	1 - 30 A	5000 A (PC1)
	JA.S - JB.S - JC.S - JE.S	2	415 V	50/60 Hz	1 - 30 A	5000 A (PC1)
	JA.S - JB.S - JC.S - JE.S	1-2	80 V	DC	1 - 30 A	5000 A (PC1)
DIN EN 60947-2* certified CENELEC	JA.S - JB.S - JC.S - JE.S	1	230 V	50/60/400 Hz	0.1 - 25 A	Icu = Ics 1000 A
	JA.S - JB.S - JC.S	2 - 4	400 V	50/60/400 Hz	0.1 - 25 A	Icu = Ics 1000 A
	JE.S	2 - 3	400 V	50/60/400 Hz	0.1 - 25 A	Icu = Ics 1000 A
	JA.S - JB.S - JC.S - JE.S	1 - 2	80 V	DC	0.1 - 30 A	Icu = Ics 1500 A
	JA.S - JB.S - JC.S - JE.S	1	65 V	DC	0.1 - 30 A	Icu = Ics 1500 A
	UL 1077 CSA C 22.2	JA.S - JB.S - JC.S	1 - 4	250 V	50/60 Hz	0.1 - 30 A
	JE.S	1 - 3	250 V	50/60 Hz	0.1 - 30 A	5000 A ①
	JA.S - JB.S - JC.S	1 - 4	277 V	50/60 Hz	0.1 - 30 A	5000 A ①
	JE.S	1 - 3	277 V	50/60 Hz	0.1 - 30 A	5000 A ①
	JA.S - JB.S - JC.S	3 - 4	415 V	50/60 Hz	3 Ø Y	1500 A ①
	JE.S	3	415 V	50/60 Hz	3 Ø Y	1500 A ①
	JA.S - JB.S - JC.S	1 - 4	240 V	400 Hz	0.1 - 30 A	1000 A ①
	JE.S	1 - 3	240 V	400 Hz	0.1 - 30 A	1000 A ①
	JA.S - JB.S - JC.S	1 - 4	65 V	DC	0.1 - 50 A	1000 A ②
	JE.S	1 - 3	65 V	DC	0.1 - 50 A	1000 A ②
	JA.S - JB.S - JC.S	1 - 4	72 V	DC	0.1 - 30 A	2200 A ②
	JE.S	1 - 3	72 V	DC	0.1 - 30 A	2200 A ②
	JA.S - JB.S - JC.S - JE.S	1	80 V	DC	0.1 - 15 A	1000 A ②
	JA.S	1	32 V	DC	0.1 - 30 A	5000 A ②
	JA.S	1	32 V	DC	31 - 50 A	5000 A ①
UL 489 A (LISTED) Category (DITT)	JA.S	1	80 V	DC	0.8 - 30 A	5000 A ②
FF F 62-001	JA.S	1	90V	DC	0.1 - 30A	800 A (5ms)
	JA.S	3	430	AC	0.1 - 30A	1200 (430VAC cos 0.9)

* Rating insulation voltage (Ui): 400 V AC
Working shock strength voltage (Uimp): 8 kV, T1/T2 = 1,2/50 μ s
Working category: A

- ① Serie fuse required: In fuse not more than 4 x In of the protector.
- ② Serie fuse not required.
- ③ A clearance of 25 mm for DC and 50 mm for AC is required between the arc vent and conductive surfaces or components.
- ④ 3 Ø Y
If you have any questions concerning Y circuit, please contact our technical support.

Safety Standards IEC 950

JS circuit breakers comply with international safety standards relating to information processing equipment IEC 950. In particular, the minimum creep distances (8 mm) between two metal parts of different potential or between the different electrical circuits are respected and the insulation voltage is 3750 V.

The circuit breakers equipped with one auxiliary contact (microswitch) enable low-voltage safety circuits to be simultaneously switched with the protection of an apparatus connected to the mains. (See figures 1 and 2).

Figure 1

One-pole circuit breaker with auxiliary contacts. The insulation voltage between the main circuits and the safety voltage circuit is 3750V.

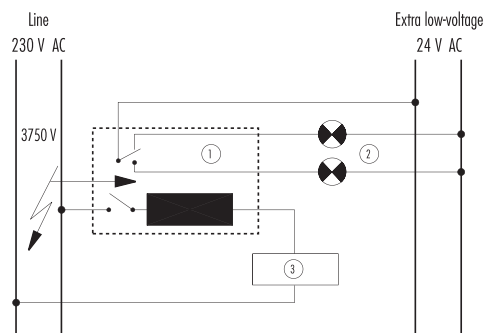

Description

1. Circuit breaker with auxiliary contact
2. Signalling
3. Circuit to be protected

Figure 2

Two-pole circuit breaker for the protection of a motor with electronic remote control.

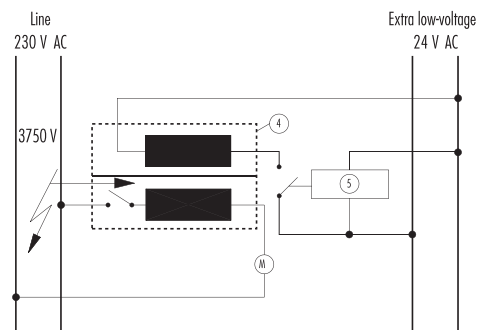

CAT - 1502 - Y4 Rev. A

Description

4. Two-pole circuit breaker; protection + low-voltage control
5. Electronic control

Switch

Construction represented: 12

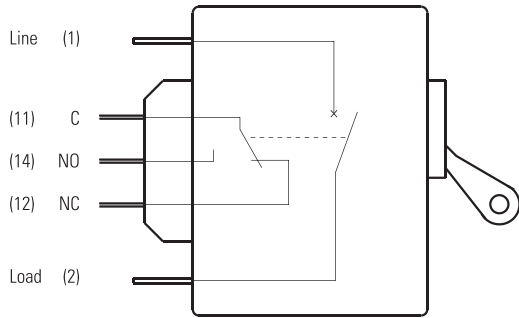

CAT - 1602 - Y4 Rev. C

Description

Switch only (without coil) with or without auxiliary contact.

Auxiliary contact	Code
With	12
Without	0

Series Trip with auxiliary contact

Construction represented: 2, 9, 39

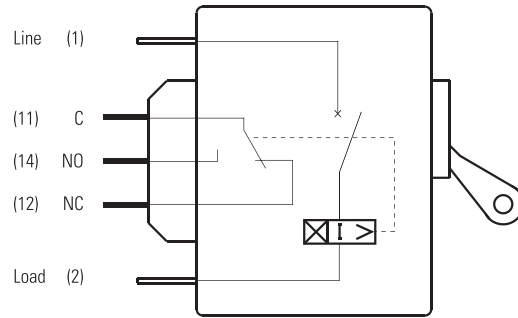

CAT - 1802 - Y4 Rev. B

Description

The contacts and the coil are in series. Auxiliary contacts are placed behind the circuit breaker and mechanically connected to the releasing system.

Inrush	Code
8x	2
15x	9
22x	39

Series Trip

Construction represented: 3, 8, 38

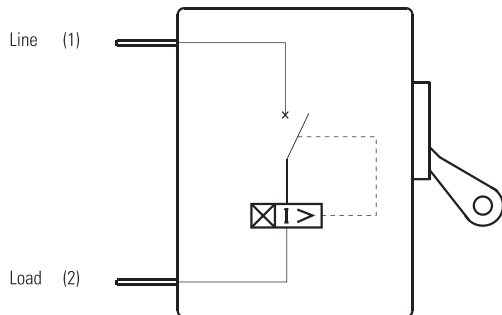

CAT - 1702 - Y4 Rev. B

Description

The contacts and the coil are in series. This is the current execution of the JS circuit breaker.

It is often used as main switch at the same time.

Inrush	Code
8x	3
15x	8
22x	38

Shunt Trip

Construction represented: 5, 22 32

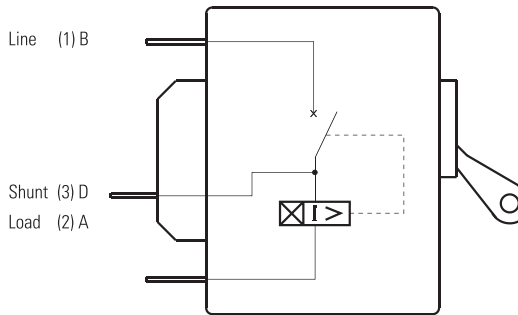

CAT - 1902 - Y4 Rev. B

Description

Enables two loads to be checked by means of a single circuit breaker. However it only releases if there is an overload in the main circuit. The sum of the two nominal currents must not exceed the peak current of the contacts. It is also possible to calibrate the trip point through a potentiometer connected between the shunt terminal (3)D and the load terminal (2)A.

Inrush	Code
8x	5
15x	22
22x	32

Relay trip

Construction represented: 6, 23, 33

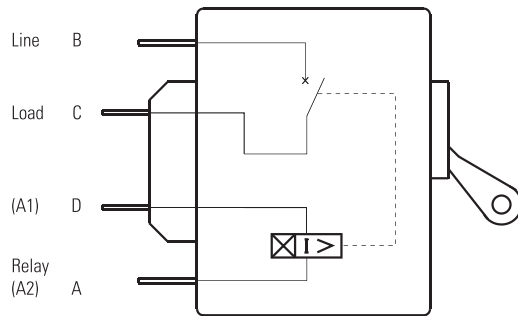

CAT - 2002- Y4 Rev. D

Description

Relay tripping can be used for releasing the circuit breaker by the intermediary of a monitor or a safety device installed at a distance. The contacts are electrically separated from the coil. Consequently, all the currents and voltages within the permissible limits can be used. Coils are either current or voltage sensitive.

The circuit breaker can be supplied on request with a dielectric strength ranging up to 2500 V on alternating current 50/60 Hz between the coil and the contacts.

Inrush	Auxiliary code	
	With	Without
8x	62	6
15x		23
22x		33

Dual Control (Ducon)

Construction represented: 15, 25

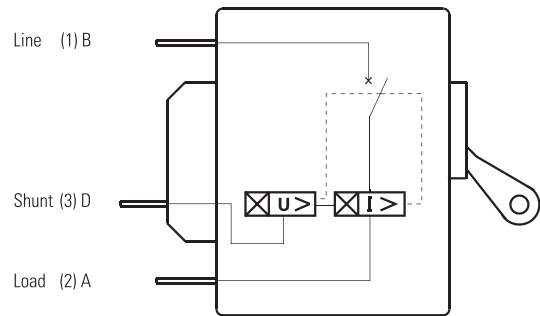

CAT - 2202 - Y4 Rev. B

Description

This version is used both for the protection of the load finding itself in series with the circuit breaker and for the release via a voltage. The main coil is in series with the contact and the DUCON coil is shunt trip.

Inrush	Auxiliary code	
	With	Without
8x	53	15
15x		25

Dual rating

Construction represented: 7, 27, 37

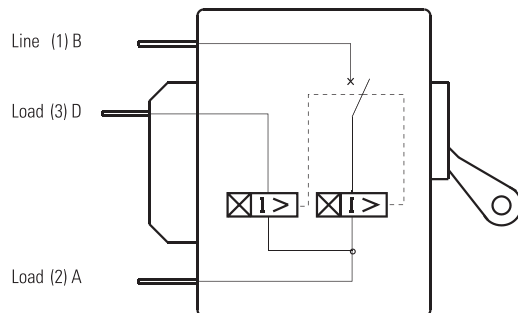

CAT - 2102 - Y4 Rev. B

Description

Dual rating circuit breakers are suitable for apparatus operating under two different currents or voltages. As far as possible, the currents must be in the ratio of one to two with a maximum of 10 to 20 A.

Inrush	Code
8x	7
15x	27
22x	37

Dual Control (Ducon) (Series + Relay)

Construction represented: 16, 26

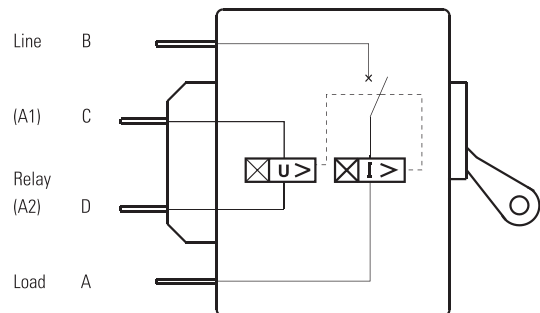

CAT - 2302 - Y4 Rev. C

Description

This version is used both for the protection of the load finding itself in series with the circuit breaker and for the release via a voltage. Same function as codes 15 and 25, but both coils are electrically separated.

Inrush	Auxiliary code	
	With	Without
8x	63	16/66*
15x		26

* 66, the two coils are electrically separated from the main contact.

Relay trip for IEC execution

Construction represented: 88

4

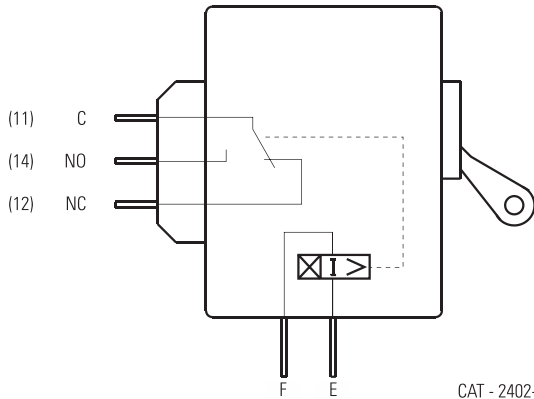

CAT - 2402- Y4 Rev. B

Description

These internal circuits have no main contact. When combined with another pole, they permit compliance with the safety regulations dictated by IEC 950.

The minimum required creepage distance between two galvanically separated electric circuits can thus be attained. (see page 15).

NB: This breaker should always be combined with one or other poles.

Inrush	Auxiliary Code	
	With	Without
8x	88	86
15x		76
22x		96

Auxiliary contact

Construction represented: 82

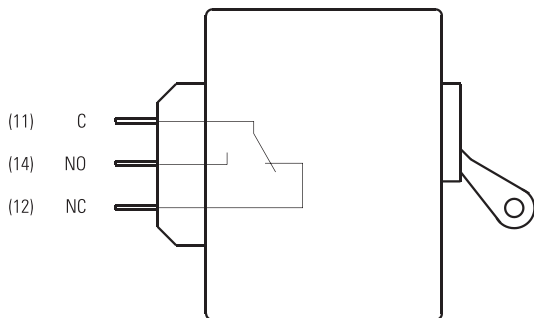

CAT - 17202 - Y4 Rev. A

Description

Auxiliary contact only without main contact and coil.

NB: This breaker should always be combined with one or other poles.

Auxiliary contact	Code
With	82

Tripping specification

All curves describe breaker response with no preloading. Curves are plotted at an ambient temperature of 25°C, with breakers in the standard wall-mount position.

All circuit breakers shall hold 100% rated load continuously.

Breakers for 50/60 Hz or DC service may trip between 101% and 125% rated load, must trip at 125% and above, as shown on the time-delay curve selected. (150% for 400 Hz).

Non-time-delay circuit breakers may (P curve) trip instantaneously between 101% and 125% of rated load, must trip instantaneously at 125% for 50/60 Hz or DC. (150% for 400 Hz).

The voltage trip breakers may trip below 100% rated voltage, must trip at 100% and above.

They are only available in no-time-delay construction (P curve).

Time delay curve codes are based on selection of high-inrush values:

Inrush	Curves		
	1	2	3
8x In	1	2	3
15x In	10	20	30
22x In	251	252	253

4

High-inrush rates valid for different curves

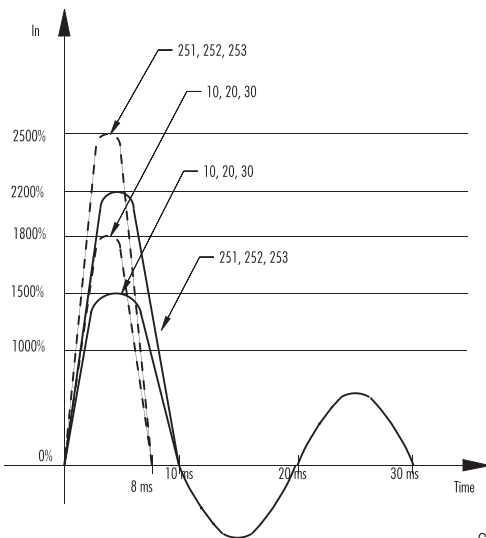

CAT - 2502 - Y4 Rev. A

JS circuit breakers are available with various levels of high-inrush currents avoiding nuisance tripping during short starting periods at turn on.

In the case of motor protection for example, causing a steep wave front transient of very high current amplitude and short duration of overload, the breaker does not trip.

By using JS high-inrush types, unnecessary and dangerous over calibrations involving use of thicker cables or wires can be avoided, thus saving energy and money.

The magnetic shunt used offers maximum possibilities on half wave which is 10 ms when frequency is 50 Hz. At 60 Hz half wave period is 8 ms based on value of 1800% instead of 1500% and 2500% instead of 2200% at 50 Hz.

For high-inrush rates see pages 12, 13 and 14. For curve P, high-inrush is not possible.

— 50 Hz
 - - - - 60 Hz

Curve P 50/60Hz, 400Hz, DC

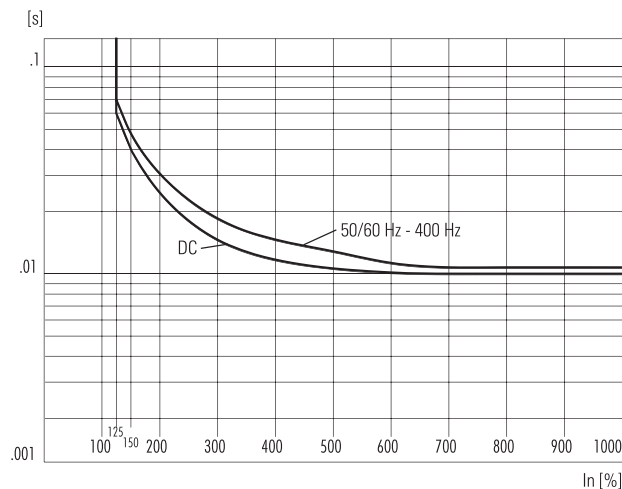

CAT - 2602 - Y4 Rev. A

	In.%	125	150	200	300	400	500	600	700	800	900	1000	1100	1200
50/60 Hz	MAX	.07	.048	.030	.019	.0165	.014	.012	.011	-	.011	-	-	.011
400 Hz	MAX	-	.048	.030	.019	.0165	.014	.012	.011	-	.011	-	-	.011
DC	MAX	.06	.040	.025	.016	.0125	.011	.010	.010	-	.010	-	-	.010

Internal circuits concerned

2, 3, 5, 6, 7, 15, 16, 53, 62, 63, 66, 86, 88

4

Technical Specifications

Time Delay Curves

Start Overload 8 x In

Internal circuits concerned: 2, 3, 5, 6, 7, 15, 16, 53, 62, 63, 66, 86, 88

Curve 2 50/60 Hz

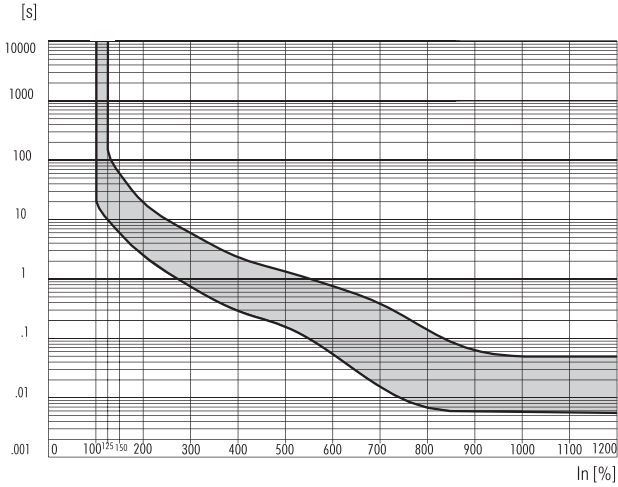

CAT - 3402 - Y4

Medium Delay

In.%	125	150	200	300	400	500	600	700	800	900	1000	1100	1200
MAX	175	60	20.0	5.00	2.30	1.50	.750	.400	.160	.065	.040	-	-
MIN	10	6	2.5	.75	.30	.17	.055	.016	.007	.006	.005	-	-

Curve 2 DC

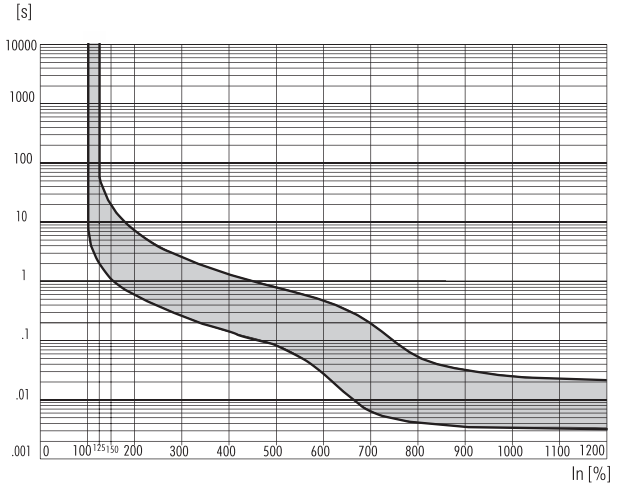

CAT - 3202 - Y4

Medium Delay

In.%	125	150	200	300	400	500	600	700	800	900	1000	1100	1200
MAX	55.0	20.0	7.50	2.80	1.40	.800	.480	.2000	.0510	.0320	.0260	-	-
MIN	2.1	1.2	.60	.27	.15	.085	.029	.0065	.0041	.0038	.0037	-	-

Curve 3 50/60 Hz

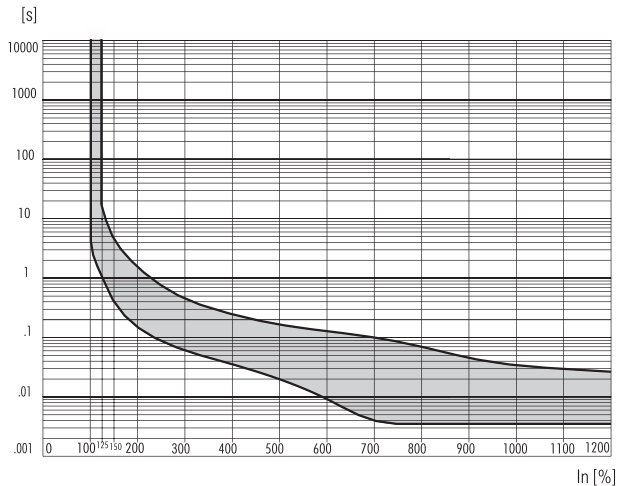

CAT - 3302 - Y4

Short Delay

In.%	125	150	200	300	400	500	600	700	800	900	1000	1100	1200
MAX	17	4.50	1.60	.46	.250	.18	.130	.100	.0700	.0450	.0350	-	-
MIN	1	.40	.16	.06	.035	.02	.009	.004	.0035	.0035	.0035	-	-

Curve 3 DC

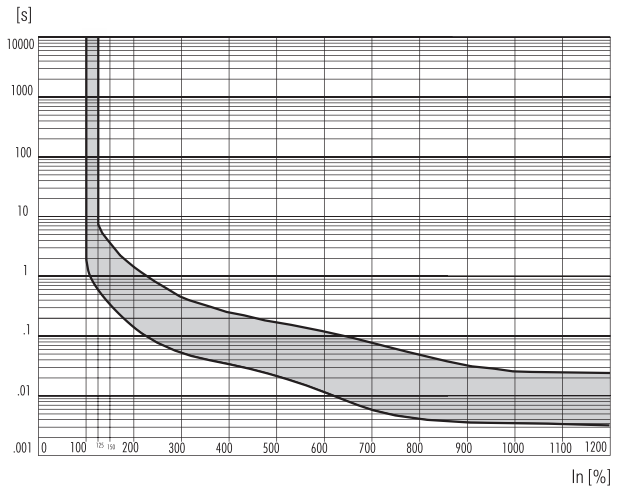

CAT - 3502 - Y4 Rev. A

Short Delay

In.%	125	150	200	300	400	500	600	700	800	900	1000	1100	1200
MAX	7.0	3.50	1.40	.420	.250	.180	.120	.080	.0510	.0320	.0260	-	-
MIN	.6	.35	.15	.055	.035	.021	.012	.006	.0041	.0038	.0037	-	-

Curve 1 400 Hz

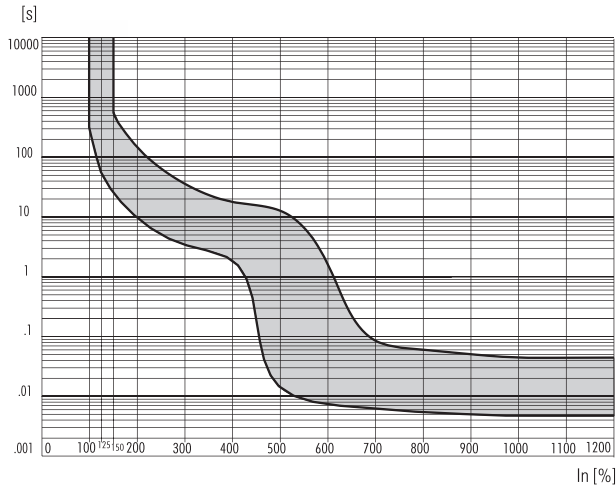

CAT - 3602 - Y4

Long Delay

In.%	125	150	200	300	400	500	600	700	800	900	1000	1100	1200
MAX	-	500	150.0	35.0	19.0	14.0	10.0	6.000	.8000	.6000	.430	-	-
MIN	-	25	9.5	3.3	1.9	.015	.0073	.0063	.0055	.005	.0049	-	-

Curve 3 400 Hz

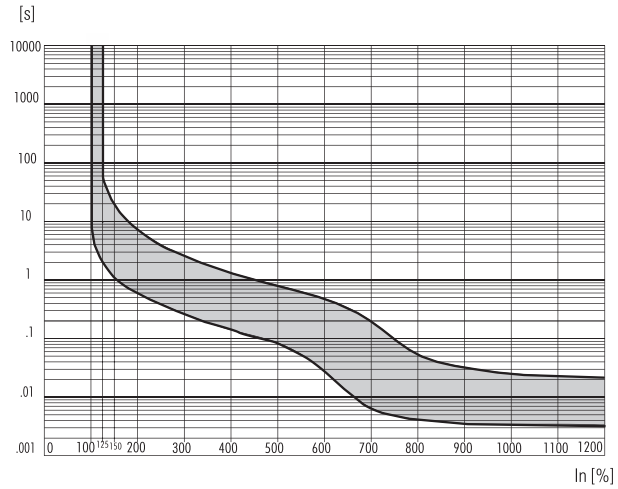

CAT - 3802 - Y4

Short Delay

In.%	125	150	200	300	400	500	600	700	800	900	1000	1100	1200
MAX	-	5.80	1.80	.460	.18	.10	.0750	.060	.0500	.042	.036	-	-
MIN	-	.55	.17	.049	.02	.01	.0065	.005	.0041	.004	.004	-	-

Curve 2 400 Hz

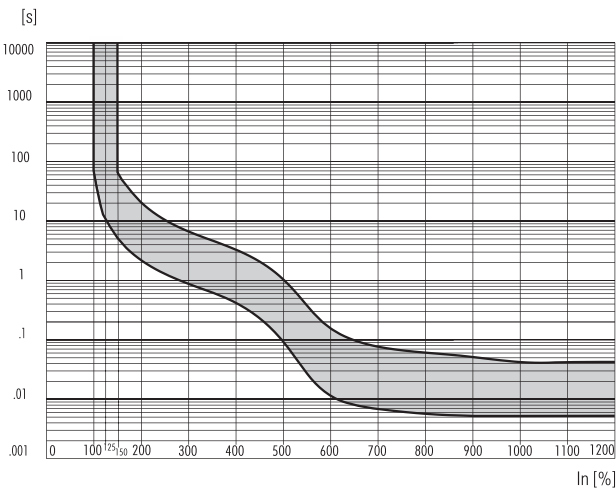

CAT - 3702 - Y4

Medium Delay

In.%	125	150	200	300	400	500	600	700	800	900	1000	1100	1200
MAX	-	60	20.0	6.50	3.10	1.00	.160	.0750	.0590	.049	.040	-	-
MIN	-	5	2.1	.85	.40	.09	.011	.0067	.0055	.005	.005	-	-

4

Technical Specifications

Time Delay Curves

Start Overload 8 x In (continued)

Combined AC/DC versions

This type of circuit breaker can be used for 50/60 Hz and DC applications. In this case the must trip point is rated at 135%.

4 Internal circuits concerned: 2, 3.

Curve 2 50/60 Hz/DC

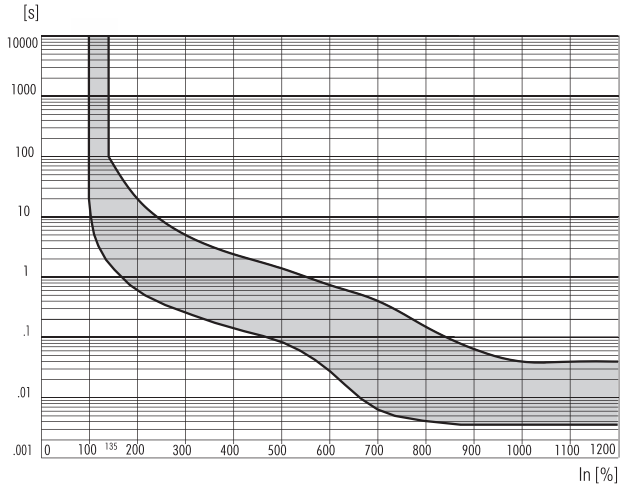

CAT - 3902 - Y4

Medium Delay

In.%	135	200	300	400	500	600	700	800	900	1000	1100	1200
MAX	100.0	20.00	5.00	2.30	1.500	.750	.4000	.1600	.0650	.0400	-	-
MIN	1.8	.60	.27	.15	.085	.029	.0065	.0041	.0038	.0037	-	-

Curve 3 50/60 Hz/DC

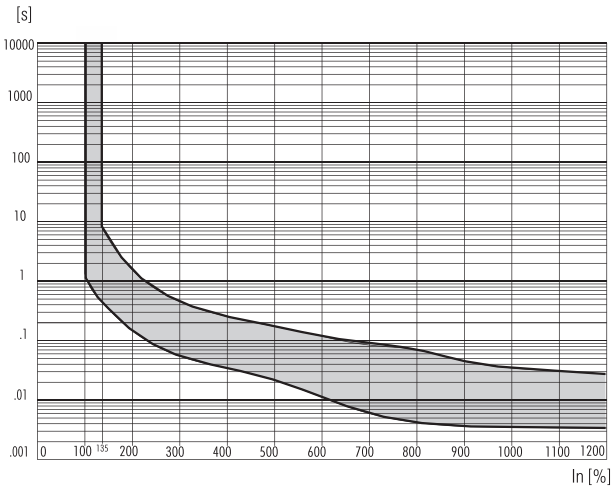

CAT - 4002 - Y4

Short Delay

In.%	135	200	300	400	500	600	700	800	900	1000	1100	1200
MAX	7.50	1.60	.460	.250	.180	.130	.8000	.0700	.0450	.0350	-	-
MIN	.45	.15	.055	.035	.021	.012	.0060	.0041	.0038	.0037	-	-

Start Overload 15 x In

Internal circuits concerned: 8, 9, 22, 23, 25*, 26*, 27, 76
 *(only with curve 20 or 30)

4

Curve 10 50/60 Hz

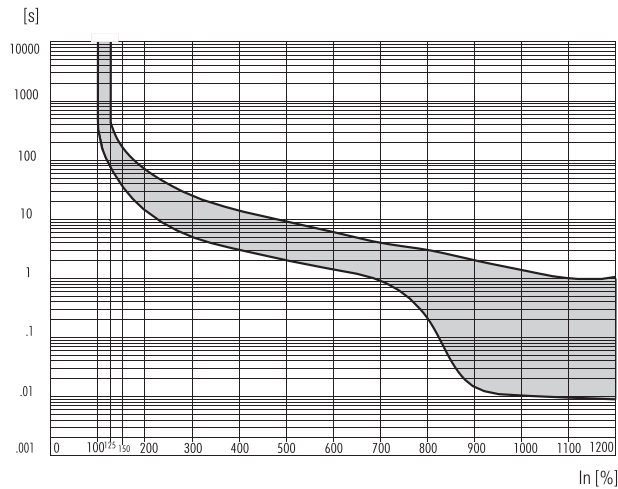

CAT - 4102 - Y4

Long Delay

In.%	125	150	200	300	400	500	600	700	800	900	1000	1100	1200
MAX	400	170	70	25	15	9	6.0	4.00	3.00	2.000	1.500	1.000	1.000
MIN	75	35	15	5	3	2	1.5	.90	.20	.015	.010	.0095	.009

Curve 30 50/60 Hz

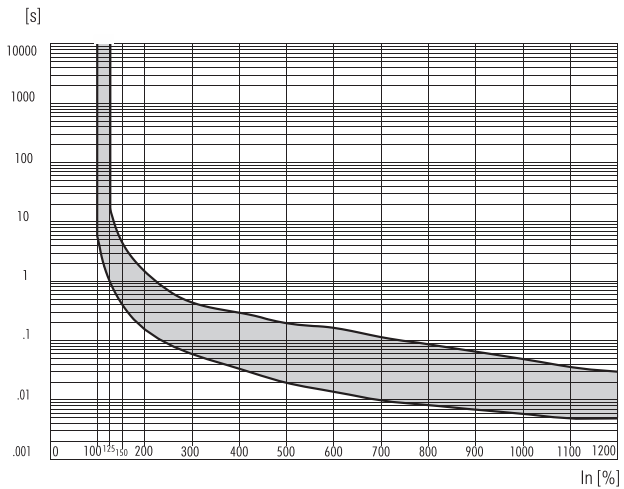

CAT - 4302 - Y4

Short Delay

In.%	125	150	200	300	400	500	600	700	800	900	1000	1100	1200
MAX	17	4.50	1.60	.46	.300	.20	.170	.12	.0900	.065	.050	.038	.030
MIN	1	.40	.16	.06	.035	.02	.015	.01	.0085	.007	.006	.005	.005

Curve 20 50/60 Hz

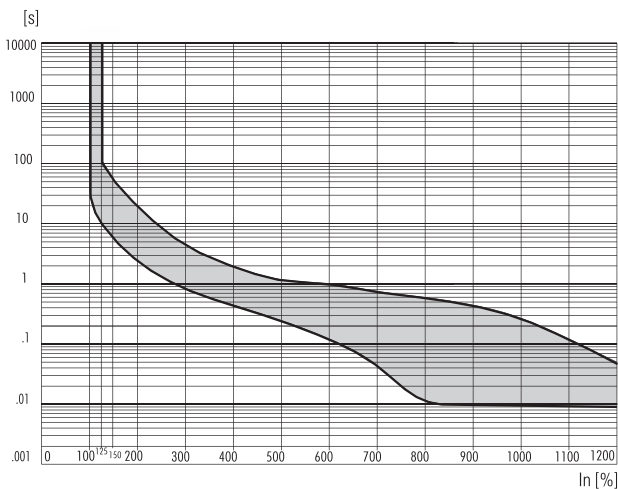

CAT - 4202 - Y4

Medium Delay

In.%	125	150	200	300	400	500	600	700	800	900	1000	1100	1200
MAX	100	55	20.0	4.50	2.00	1.20	1.00	.750	.600	.45	.29	.12	.05
MIN	10	6	2.5	.85	.45	.25	.13	.045	.012	.01	.01	.01	.01

4

Technical Specifications

Time Delay Curves

Start Overload 15 x In (continued)

Internal circuits concerned: 8, 9, 22, 23, 25*, 26*, 27, 76

*(only with curve 20 or 30)

4

Curve 10 DC

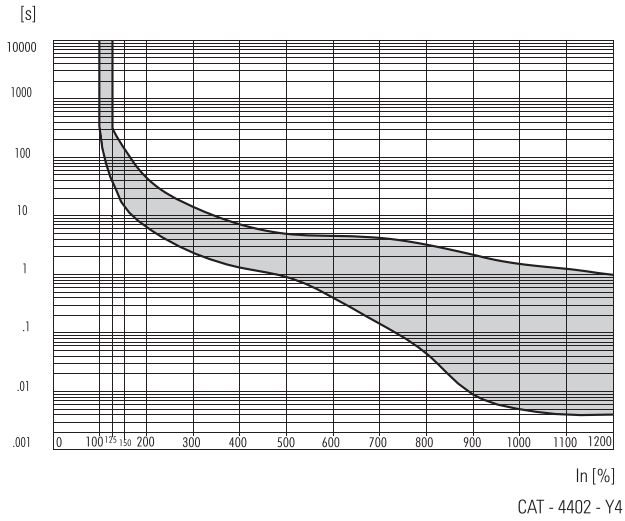

Long Delay

In.%	125	150	200	300	400	500	600	700	800	900	1000	1100	1200
MAX	300	150	45.0	15.0	7.1	5.00	4.90	4.10	3.100	2.200	1.600	1.300	.850
MIN	35	15	6.5	2.3	1.4	.90	.40	.15	.045	.009	.005	.004	.004

Curve 30 DC

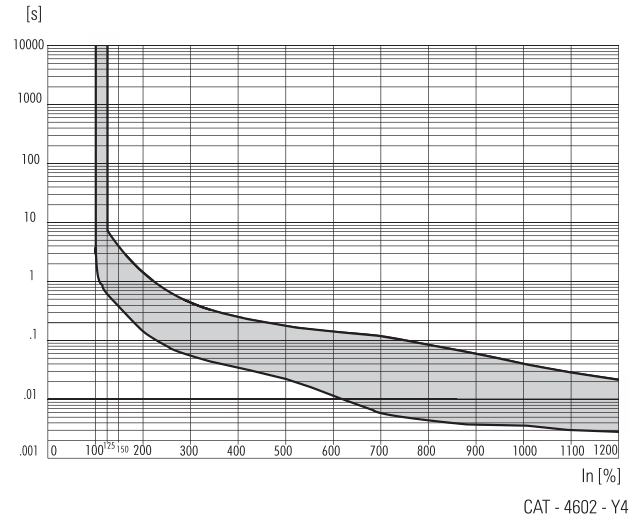

Short Delay

In.%	125	150	200	300	400	500	600	700	800	900	1000	1100	1200
MAX	7.00	4.00	1.40	.420	.250	.180	.150	.120	.0850	.0590	.0400	.029	.021
MIN	.60	.40	.15	.055	.035	.021	.012	.006	.0041	.0038	.0037	.003	.003

Curve 20 DC

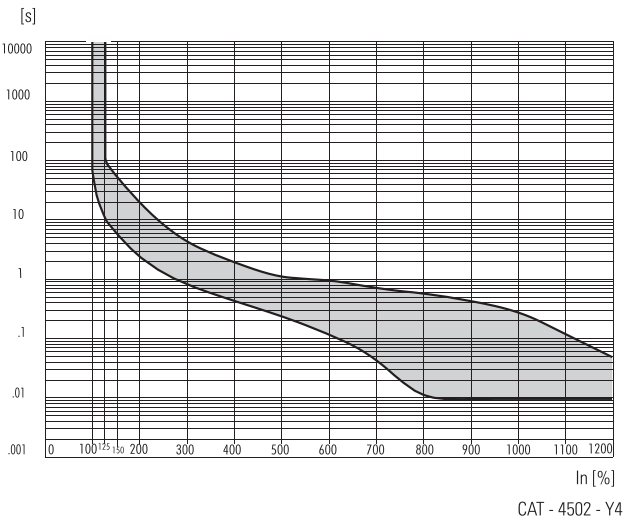

Medium Delay

In.%	125	150	200	300	400	500	600	700	800	900	1000	1100	1200
MAX	100	55	20.0	4.50	2.00	1.20	1.00	.750	.600	.45	.29	.12	.05
MIN	10	6	2.5	.85	.45	.25	.13	.045	.012	.01	.01	.01	.01

Combined AC/DC versions

This type of circuit breaker can be used for 50/60 Hz and DC applications. In this case the must trip point is rated at 135%.

Internal circuits concerned: 8, 9

4

Curve 10 50/60 Hz/DC

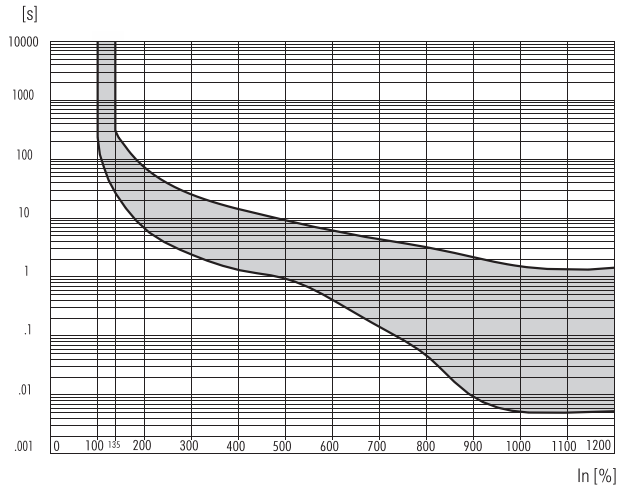

Long Delay												
In.%	135	200	300	400	500	600	700	800	900	1000	1100	1200
MAX	280	70.0	25.0	15.0	9.00	6.00	4.10	3.100	2.200	1.600	-	-
MIN	24	6.5	2.3	1.4	.90	.40	.15	.045	.009	.005	-	-

Curve 30 50/60 Hz/DC

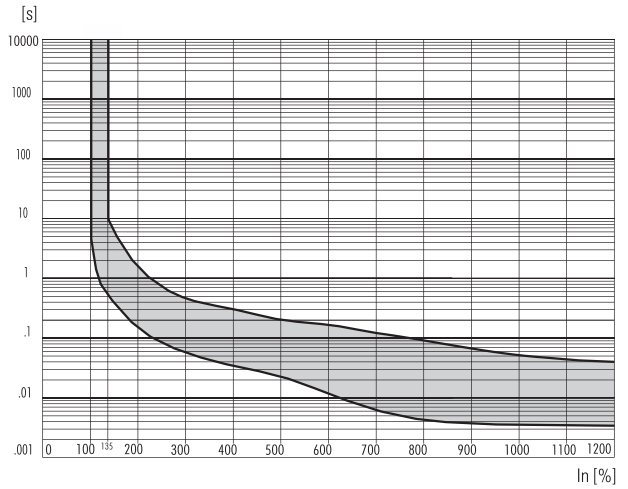

Short Delay												
In.%	135	200	300	400	500	600	700	800	900	1000	1100	1200
MAX	8.80	1.60	.460	.300	.200	.170	.120	.0900	.0650	.0500	-	-
MIN	.49	.15	.055	.035	.021	.012	.006	.0041	.0038	.0037	-	-

Curve 20 50/60 Hz/DC

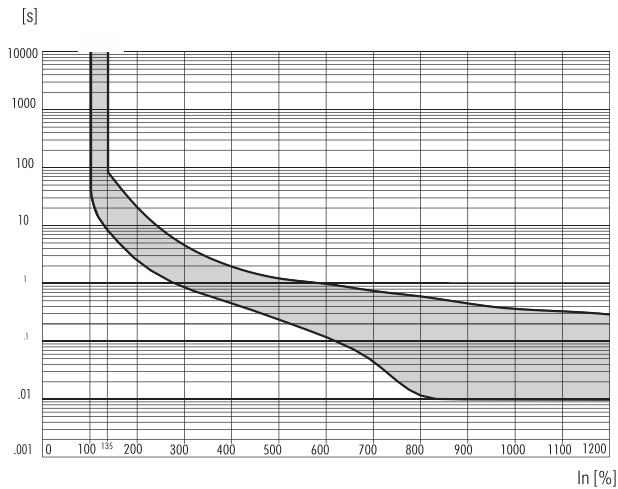

Medium Delay												
In.%	135	200	300	400	500	600	700	800	900	1000	1100	1200
MAX	85.0	20.0	4.50	2.00	1.20	1.00	.750	.600	.450	.290	-	-
MIN	8.0	2.5	.85	.45	.25	.13	.045	.012	.010	.010	-	-

4

Technical Specifications

Time Delay Curves

Start Overload 22 x In

Internal circuits concerned: 32, 33, 37, 38, 39, 96

4

Curve 251 50/60 Hz or DC

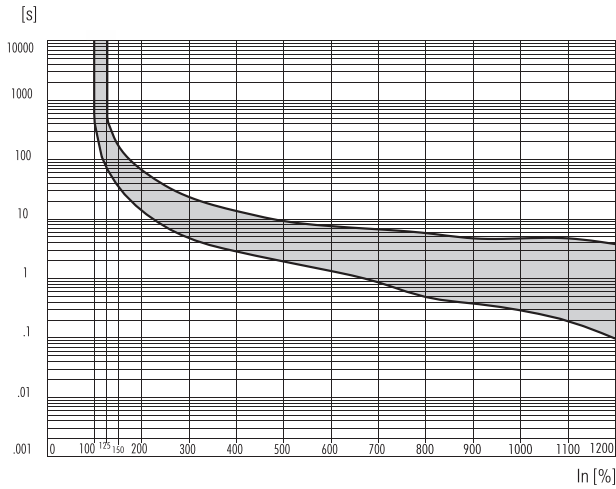

CAT - 5002 - Y4

Long Delay													
In.%	125	150	200	300	400	500	600	700	800	900	1000	1100	1200
MAX	400	170	70	25	15	9.5	8.0	7.0	6.0	5.0	5.0	5.0	4.0
MIN	75	35	15	5	3	2.0	1.5	.9	.5	.4	.3	.2	.1

Curve 253 50/60 Hz or DC

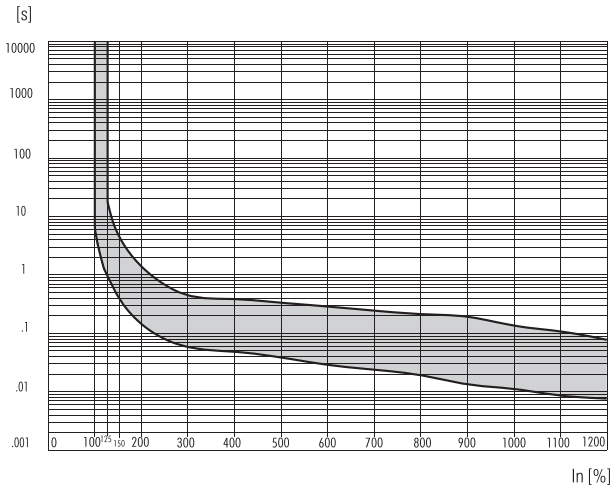

CAT - 5202 - Y4

Short Delay													
In.%	125	150	200	300	400	500	600	700	800	900	1000	1100	1200
MAX	17	4.50	1.60	.46	.40	.35	.30	.250	.220	.200	.150	.120	.080
MIN	1	.40	.16	.06	.05	.04	.03	.025	.020	.015	.012	.009	.008

Curve 252 50/60 Hz or DC

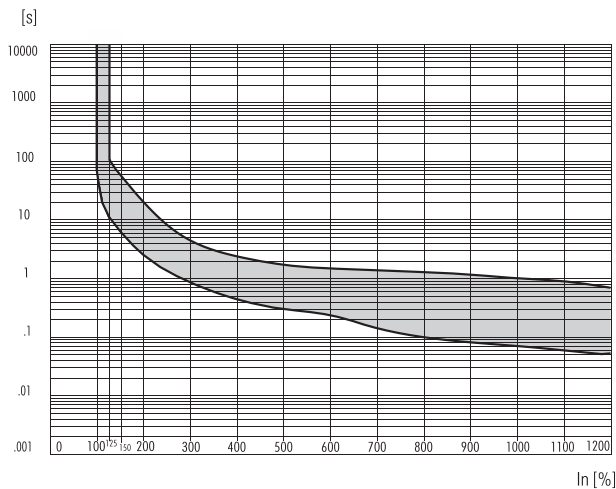

CAT - 5102 - Y4

Medium Delay													
In.%	125	150	200	300	400	500	600	700	800	900	1000	1100	1200
MAX	100	55	20.0	4.50	2.50	1.80	1.60	1.50	1.40	1.20	1.00	.90	.70
MIN	10	6	2.5	.85	.45	.30	.22	.15	.10	.08	.07	.06	.05