

## Bearing specification tables

# Contents

## Standard bearings

**Deep groove ball bearings** ..... B 4

- Single-row
  - Open type..... B 8
  - Shielded/sealed type ..... B 20
  - Snap ring groove/  
locating snap ring type ..... B 32
- Extra-small, miniature ball bearings
  - Open/shielded/sealed type..... B 38
  - Flanged type (open/shielded type)... B 44
- Double-row ..... B 50

**Angular contact ball bearings** .... B 52

- Single-row ..... B 60
- Matched pair ..... B 88
- Double-row ..... B 116

**Self-aligning ball bearings** ..... B 122

- Open type ..... B 124
- Sealed type ..... B 130
- Extended inner ring type ..... B 132
- Adapter assemblies for self-aligning ball bearings ... B 134

**Cylindrical roller bearings** ..... B 136

- Single-row ..... B 140
- Thrust collars ..... B 166
- Double-row ..... B 176

**Tapered roller bearings** ..... B 182

- Single-row
  - Metric series ..... B 186
  - Inch series ..... B 216
- Double-row
  - TDO type ..... B 260
  - TDI type..... B 276

**Spherical roller bearings** ..... B 282

- Spherical roller bearings ..... B 286
- Adapter assemblies  
for spherical roller bearings ..... B 310
- Withdrawal sleeves  
for spherical roller bearings ..... B 318

**Thrust ball bearings** ..... B 328

- Single direction ..... B 330
- Double direction ..... B 340

**Spherical thrust roller bearings** .... B 346

**Needle roller bearings** ..... B 354

- Needle roller and cage assemblies... B 372
- Drawn cup type ..... B 406
- Heavy-duty type ..... B 424
- Thrust ..... B 436
- Combined ..... B 452
- Inner ring ..... B 458
- (Miniature one-way clutches) ..... B 474

## [Introduction]

**Ball bearing units** ..... B 478

## Special purpose bearings

**K-series super thin section ball bearings** ..... C 1

- Deep groove type } ..... C 9
- Angular contact type } ..... C 9
- Four-point contact type } ..... C 9
- Sealed type ..... C 19

**Bearings for railway rolling stock axle journals** ..... C 21

- Cylindrical roller bearings ..... C 25
- Sealed type cylindrical roller bearings ..... C 27
- Sealed type tapered roller bearings  
(ABU bearing) ..... C 29

**Linear ball bearings** ..... C 31

- Linear ball bearings ..... C 35
- Flanged type ..... C 41

**Accessories** ..... C 45

- Locknuts ..... C 47
- Lockwashers ..... C 53
- Lock plates ..... C 55

## [Introduction]

**Ceramic & EXSEV bearing series** .... C 57

**Bearings for machine tool spindles (for support of axial loading)** ..... C 59

**Precision ball screw support bearings and bearing units** ..... C 61

**Full complement type cylindrical roller bearings for crane sheaves** ..... C 63

**Rolling mill roll neck bearings** ... C 65

## Deep groove ball bearings

Deep groove ball bearings are available in a variety of sizes, and are the most popular of all rolling bearings. This type of bearing supports radial load and a certain degree of axial load in both directions simultaneously.

- Shielded / sealed type
  - Simplifies sealing structure of applications.
  - Greasing is not necessary because bearings are pre-lubricated.
  - Table 1 on the next page lists major shielded and sealed bearing types and compares their performance.
- With locating snap ring
  - Bearings with a locating snap ring can be fit to the housing easily, as the locating snap ring facilitates axial positioning.
- Extra-small ball bearings and miniature ball bearings
  - The open type is widely used. Also available are the shielded/sealed type and the flanged type; the latter is easily positioned in the axial direction.



### Single-row deep groove ball bearings



Open type

Bore diameter **10 – 500 mm**



Shielded/sealed type

Bore diameter **10 – 220 mm**



With snap ring groove    With locating snap ring

Bore diameter **10 – 130 mm**

### Extra-small ball bearings and miniature ball bearings



Bore diameter **1 – 9 mm**



Flanged type

Bore diameter **1 – 9 mm**








### Double-row deep groove ball bearings



(with filling slot)

Bore diameter **10 – 75 mm**

**Table 1 Comparison of shielded and sealed bearing performance**

Type	Shielded		Sealed				
	Non-contact type		Non-contact type	Contact type		Extremely light contact type	
	ZZ type		2RU type	2RS type	2RK type	2RD type	
Characteristics	 (a) <sup>1)</sup>	 (b)	 (c)	 (d) <sup>2)</sup>	 (e)	 (f)	 (g)
Friction torque	Small		Small	Large		Small	
High speed performance	Good		Good	Limited because of contact		Good	
Grease sealing property	Good		Better than ZZ type	Better than 2RU type for low-speed applications	Excellent	Excellent	
Dirt resistance	Good		Better than ZZ type	Better than 2RU type	Excellent	Excellent	
Water resistance	Economical		Better than ZZ type but inferior to 2RS, 2RK and 2RD types	Good	Excellent	Better than ZZ and 2RU types	
Operating temperature <sup>3)</sup>	- 30 to +110°C			- 30 to +100°C		- 30 to +110°C	

[Notes] 1) Illustration (a) of the ZZ type shows the relatively small size bearing.  
 2) Illustration (d) of the 2RS type shows the relatively small size bearing.  
 3) The operating temperature range listed is for the standard type. It can be widened by using a different type of grease or sealing material. Consult with JTEKT for details.

■ Handling instructions

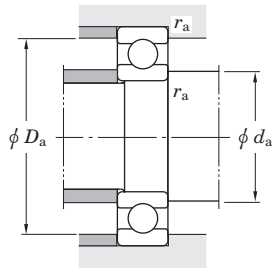
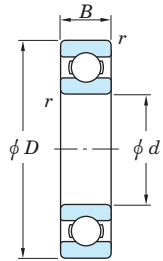
- 1) The shielded/sealed type deep groove ball bearing and the deep groove ball bearing with a locating snap ring are designed for use with the inner ring rotating. Consult with JTEKT on use with the outer ring rotating.
- 2) When the axial load is large, make the shaft shoulder and housing shoulder larger than usual. (Referring to the specification table, make the mounting dimension  $d_a$  larger and make  $D_a$  smaller.)

Boundary dimensions	The dimensions of standard series are as specified in JIS B 1512. For extra-small and miniature ball bearings, special series (ML) are specified together with those described above.																																																																			
Tolerances	As specified in JIS B 1514-1. (refer to Table 7-3 on pp. A 60 – A 63.)																																																																			
Radial internal clearance	<ul style="list-style-type: none"> <li>■ Deep groove ball bearings (except extra-small ball bearings and miniature ball bearings) ..... as specified in JIS B 1520 (refer to Table 10-2 on p. A 102.)</li> <li>■ Extra-small ball bearings and miniature ball bearings ..... (refer to Table 10-3 on p. A 102.)</li> <li>■ Deep groove ball bearings for motors ..... (refer to Table 10-6 on p. A 105.)</li> </ul>																																																																			
Recommended fits	<ul style="list-style-type: none"> <li>■ Bearings of classes 0 and 6 ..... (refer to Table 9-4 on pp. A 91, 92.)</li> <li>■ Precision extra-small ball bearings and miniature ball bearings ..... (refer to Table 9-5 on p. A 93.)</li> </ul>																																																																			
Standard cages	<ul style="list-style-type: none"> <li>● Polyamide molded cage (supplementary code : FG, MG )</li> <li>● Pressed steel cage (supplementary code : // )</li> <li>● Copper alloy machined cage (supplementary code : FY )</li> </ul> <p>[Remark] For certain applications, stainless steel sheet pressed cages (YS) may also be used.</p> <table border="1" style="margin-left: 20px;"> <thead> <tr> <th colspan="4">Application of standard cages</th> </tr> <tr> <th>Bearing series</th> <th>Molded cage</th> <th>Pressed cage</th> <th>Machined cage</th> </tr> </thead> <tbody> <tr> <td>68</td> <td>683 – 689</td> <td>-</td> <td>-</td> </tr> <tr> <td>69</td> <td>693 – 699</td> <td>-</td> <td>-</td> </tr> <tr> <td>60</td> <td>603 – 609</td> <td>-</td> <td>-</td> </tr> <tr> <td>62</td> <td>623 – 629</td> <td>-</td> <td>-</td> </tr> <tr> <td>63</td> <td>633 – 639</td> <td>-</td> <td>-</td> </tr> <tr> <td>68</td> <td>-</td> <td>6800 – 6838</td> <td>6840 – 68/600</td> </tr> <tr> <td>69</td> <td>-</td> <td>6900 – 6918</td> <td>6920 – 6980</td> </tr> <tr> <td>160</td> <td>-</td> <td>16001 – 16028</td> <td>16030 – 16072</td> </tr> <tr> <td>60</td> <td>6000 – 6009</td> <td>6010 – 6034</td> <td>6036 – 6084</td> </tr> <tr> <td>62</td> <td>6200 – 6208</td> <td>6209 – 6230</td> <td>6232 – 6248</td> </tr> <tr> <td>63</td> <td>6300 – 6306</td> <td>6307 – 6328</td> <td>6330 – 6340</td> </tr> <tr> <td>64</td> <td>-</td> <td>6403 – 6418</td> <td>-</td> </tr> <tr> <td>42</td> <td>-</td> <td>4200 – 4215</td> <td>-</td> </tr> <tr> <td>43</td> <td>-</td> <td>4302 – 4315</td> <td>-</td> </tr> </tbody> </table>				Application of standard cages				Bearing series	Molded cage	Pressed cage	Machined cage	68	683 – 689	-	-	69	693 – 699	-	-	60	603 – 609	-	-	62	623 – 629	-	-	63	633 – 639	-	-	68	-	6800 – 6838	6840 – 68/600	69	-	6900 – 6918	6920 – 6980	160	-	16001 – 16028	16030 – 16072	60	6000 – 6009	6010 – 6034	6036 – 6084	62	6200 – 6208	6209 – 6230	6232 – 6248	63	6300 – 6306	6307 – 6328	6330 – 6340	64	-	6403 – 6418	-	42	-	4200 – 4215	-	43	-	4302 – 4315	-
Application of standard cages																																																																				
Bearing series	Molded cage	Pressed cage	Machined cage																																																																	
68	683 – 689	-	-																																																																	
69	693 – 699	-	-																																																																	
60	603 – 609	-	-																																																																	
62	623 – 629	-	-																																																																	
63	633 – 639	-	-																																																																	
68	-	6800 – 6838	6840 – 68/600																																																																	
69	-	6900 – 6918	6920 – 6980																																																																	
160	-	16001 – 16028	16030 – 16072																																																																	
60	6000 – 6009	6010 – 6034	6036 – 6084																																																																	
62	6200 – 6208	6209 – 6230	6232 – 6248																																																																	
63	6300 – 6306	6307 – 6328	6330 – 6340																																																																	
64	-	6403 – 6418	-																																																																	
42	-	4200 – 4215	-																																																																	
43	-	4302 – 4315	-																																																																	
Allowable misalignment	0.002 3 – 0.003 4 rad ( 8' – 12' )																																																																			
Equivalent radial load (Single/double-row)	<p>Dynamic equivalent radial load  <math>P_r = XF_r + YF_a</math>                      (refer to the table on the right for values X and Y.)</p> <p>Static equivalent radial load  <math>P_{0r} = 0.6F_r + 0.5F_a</math>                      (when the value of <math>P_{0r} &lt; F_r</math>, <math>P_{0r} = F_r</math>)</p> <table border="1" style="margin-left: 20px;"> <thead> <tr> <th rowspan="2"><math>\frac{if_0F_a}{C_{0r}}</math></th> <th rowspan="2">e</th> <th colspan="2"><math>\frac{F_a}{F_r} \leq e</math></th> <th colspan="2"><math>\frac{F_a}{F_r} &gt; e</math></th> </tr> <tr> <th>X</th> <th>Y</th> <th>X</th> <th>Y</th> </tr> </thead> <tbody> <tr> <td>0.172</td> <td>0.19</td> <td></td> <td></td> <td></td> <td>2.30</td> </tr> <tr> <td>0.345</td> <td>0.22</td> <td></td> <td></td> <td></td> <td>1.99</td> </tr> <tr> <td>0.689</td> <td>0.26</td> <td></td> <td></td> <td></td> <td>1.71</td> </tr> <tr> <td>1.03</td> <td>0.28</td> <td rowspan="5">1</td> <td rowspan="5">0</td> <td rowspan="5">0.56</td> <td>1.55</td> </tr> <tr> <td>1.38</td> <td>0.30</td> <td>1.45</td> </tr> <tr> <td>2.07</td> <td>0.34</td> <td>1.31</td> </tr> <tr> <td>3.45</td> <td>0.38</td> <td>1.15</td> </tr> <tr> <td>5.17</td> <td>0.42</td> <td>1.04</td> </tr> <tr> <td>6.89</td> <td>0.44</td> <td></td> <td></td> <td></td> <td>1.00</td> </tr> </tbody> </table>				$\frac{if_0F_a}{C_{0r}}$	e	$\frac{F_a}{F_r} \leq e$		$\frac{F_a}{F_r} > e$		X	Y	X	Y	0.172	0.19				2.30	0.345	0.22				1.99	0.689	0.26				1.71	1.03	0.28	1	0	0.56	1.55	1.38	0.30	1.45	2.07	0.34	1.31	3.45	0.38	1.15	5.17	0.42	1.04	6.89	0.44				1.00												
$\frac{if_0F_a}{C_{0r}}$	e	$\frac{F_a}{F_r} \leq e$		$\frac{F_a}{F_r} > e$																																																																
		X	Y	X	Y																																																															
0.172	0.19				2.30																																																															
0.345	0.22				1.99																																																															
0.689	0.26				1.71																																																															
1.03	0.28	1	0	0.56	1.55																																																															
1.38	0.30				1.45																																																															
2.07	0.34				1.31																																																															
3.45	0.38				1.15																																																															
5.17	0.42				1.04																																																															
6.89	0.44				1.00																																																															

Factor  $f_0$  is shown in the bearing dimension table.

Single-row deep groove ball bearings  
open type

*d* 10 ~ (20) mm



*d* (20) ~ (30) mm

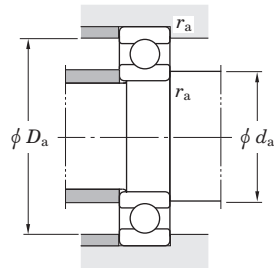
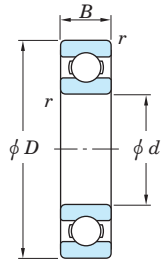
Boundary dimensions (mm)	Basic load ratings (kN)		Fatigue load limit (kN) <i>C<sub>u</sub></i>	Factor <i>f<sub>0</sub></i>	Limiting speeds (min <sup>-1</sup> )		Mounting dimensions (mm)	(Refer.) Mass (kg)	Bearing No.					
					Grease lub.	Oil lub.								
<i>d</i>	<i>D</i>	<i>B</i>	<i>r<sub>min.</sub></i>	<i>C<sub>r</sub></i>	<i>C<sub>0r</sub></i>	<i>f<sub>0</sub></i>	<i>d<sub>a</sub></i> min.	<i>D<sub>a</sub></i> max.	<i>r<sub>a</sub></i> max.					
<b>10</b>	19	5	0.3	2.15	0.84	0.030	14.8	37 000	43 000	<b>6800</b>	12	17	0.3	0.005
	22	6	0.3	3.35	1.25	0.070	14.0	34 000	41 000	<b>6900</b>	12	20	0.3	0.010
	26	8	0.3	5.70	1.95	0.100	12.3	31 000	36 000	<b>6000</b>	12	24	0.3	0.019
	30	9	0.6	6.40	2.40	0.120	13.2	24 000	29 000	<b>6200</b>	14	26	0.6	0.032
	35	11	0.6	10.1	3.45	0.270	11.2	22 000	27 000	<b>6300</b>	14	31	0.6	0.053
<b>12</b>	21	5	0.3	2.40	1.05	0.040	15.3	33 000	39 000	<b>6801</b>	14	19	0.3	0.006
	24	6	0.3	3.60	1.45	0.080	14.5	31 000	36 000	<b>6901</b>	14	22	0.3	0.011
	28	7	0.3	6.40	2.40	0.120	13.2	27 000	32 000	<b>16001</b>	14	26	0.3	0.024
	28	8	0.3	6.40	2.40	0.120	13.2	27 000	32 000	<b>6001</b>	14	26	0.3	0.022
	32	10	0.6	8.50	3.05	0.240	12.3	22 000	27 000	<b>6201</b>	16	28	0.6	0.037
	37	12	1	12.1	4.20	0.420	11.1	20 000	25 000	<b>6301</b>	17	32	1	0.060
	<b>15</b>	24	5	0.3	2.60	1.25	0.050	15.8	28 000	33 000	<b>6802</b>	17	22	0.3
28		7	0.3	5.40	2.25	0.120	14.3	26 000	30 000	<b>6902</b>	17	26	0.3	0.017
32		8	0.3	7.00	2.85	0.150	13.9	23 000	28 000	<b>16002</b>	17	30	0.3	0.025
32		9	0.3	7.00	2.85	0.150	13.9	23 000	27 000	<b>6002</b>	17	30	0.3	0.030
35		11	0.6	9.55	3.75	0.290	13.2	20 000	24 000	<b>6202</b>	19	31	0.6	0.045
42		13	1	14.3	5.45	0.460	12.3	17 000	20 000	<b>6302</b>	20	37	1	0.082
<b>17</b>		26	5	0.3	3.30	1.55	0.060	15.7	26 000	30 000	<b>6803</b>	19	24	0.3
	30	7	0.3	5.75	2.55	0.130	14.7	23 000	28 000	<b>6903</b>	19	28	0.3	0.018
	35	8	0.3	7.50	3.25	0.170	14.4	21 000	25 000	<b>16003</b>	19	33	0.3	0.032
	35	10	0.3	7.50	3.25	0.170	14.4	21 000	25 000	<b>6003</b>	19	33	0.3	0.039
	40	12	0.6	12.0	4.80	0.370	13.2	17 000	21 000	<b>6203</b>	21	36	0.6	0.065
	47	14	1	17.0	6.65	0.550	12.4	15 000	18 000	<b>6303</b>	22	42	1	0.115
	47	14	1	19.6	7.60	0.680	12.0	15 000	18 000	<b>6303R</b>	22	42	1	0.121
	62	17	1.1	25.9	9.85	0.920	11.6	13 000	15 000	<b>6403</b>	23.5	55.5	1	0.270
<b>20</b>	32	7	0.3	5.00	2.45	0.100	15.5	21 000	25 000	<b>6804</b>	22	30	0.3	0.018
	37	9	0.3	7.95	3.70	0.190	14.7	19 000	23 000	<b>6904</b>	22	35	0.3	0.036
	42	8	0.3	9.90	4.50	0.290	14.4	17 000	21 000	<b>16004</b>	22	40	0.3	0.050

[Remark] Standard cage types used for the above bearings are described earlier in this section.

Boundary dimensions (mm)	Basic load ratings (kN)		Fatigue load limit (kN) <i>C<sub>u</sub></i>	Factor <i>f<sub>0</sub></i>	Limiting speeds (min <sup>-1</sup> )		Mounting dimensions (mm)	(Refer.) Mass (kg)	Bearing No.					
					Grease lub.	Oil lub.								
<i>d</i>	<i>D</i>	<i>B</i>	<i>r<sub>min.</sub></i>	<i>C<sub>r</sub></i>	<i>C<sub>0r</sub></i>	<i>f<sub>0</sub></i>	<i>d<sub>a</sub></i> min.	<i>D<sub>a</sub></i> max.	<i>r<sub>a</sub></i> max.					
<b>20</b>	42	12	0.6	11.7	5.05	0.350	13.9	17 000	21 000	<b>6004</b>	24	38	0.6	0.069
	42	12	0.6	14.4	5.85	0.460	13.0	18 000	21 000	<b>6004R</b>	24	38	0.6	0.073
	47	14	1	16.0	6.65	0.510	13.2	15 000	17 000	<b>6204</b>	25	42	1	0.106
	47	14	1	19.6	7.60	0.680	12.0	15 000	18 000	<b>6204R</b>	25	42	1	0.114
	52	15	1.1	19.9	7.85	0.660	12.3	14 000	17 000	<b>6304</b>	26.5	45.5	1	0.144
	52	15	1.1	22.6	8.95	0.790	12.0	14 000	16 000	<b>6304R</b>	26.5	45.5	1	0.151
	72	19	1.1	38.7	15.2	1.50	11.1	11 000	13 000	<b>6404</b>	26.5	65.5	1	0.400
	<b>22</b>	44	12	0.6	11.7	5.15	0.350	14.1	17 000	20 000	<b>60/22</b>	26	40	0.6
50		14	1	16.0	6.65	0.510	13.2	15 000	17 000	<b>62/22</b>	27	45	1	0.118
56		16	1.1	23.1	9.40	0.770	12.6	13 000	15 000	<b>63/22</b>	28.5	49.5	1	0.201
<b>25</b>	37	7	0.3	5.40	2.95	0.120	16.0	18 000	21 000	<b>6805</b>	27	35	0.3	0.022
	42	9	0.3	8.75	4.55	0.230	15.4	16 000	19 000	<b>6905</b>	27	40	0.3	0.041
	47	8	0.3	11.1	5.60	0.340	15.1	15 000	18 000	<b>16005</b>	27	45	0.3	0.060
	47	12	0.6	12.6	5.85	0.380	14.5	15 000	18 000	<b>6005</b>	29	43	0.6	0.080
	52	15	1	17.5	7.85	0.550	13.9	13 000	15 000	<b>6205</b>	30	47	1	0.128
	52	15	1	22.1	9.30	0.740	12.8	13 000	16 000	<b>6205R</b>	30	47	1	0.138
	62	17	1.1	25.7	11.3	0.860	13.2	11 000	13 000	<b>6305</b>	31.5	55.5	1	0.232
	62	17	1.1	32.7	13.4	1.20	11.9	11 000	14 000	<b>6305R</b>	31.5	55.5	1	0.255
80	21	1.5	45.2	19.4	1.65	12.2	9 100	11 000	<b>6405</b>	33	72	1.5	0.530	
<b>28</b>	52	12	0.6	15.6	7.40	0.480	14.5	14 000	16 000	<b>60/28</b>	32	48	0.6	0.097
	58	16	1	22.4	9.75	0.720	13.4	12 000	14 000	<b>62/28</b>	33	53	1	0.173
	68	18	1.1	29.4	13.1	0.990	13.3	10 000	12 000	<b>63/28</b>	34.5	61.5	1	0.328
<b>30</b>	42	7	0.3	5.65	3.40	0.140	16.4	15 000	18 000	<b>6806</b>	32	40	0.3	0.026
	47	9	0.3	9.05	5.00	0.260	15.8	14 000	17 000	<b>6906</b>	32	45	0.3	0.045
	55	9	0.3	14.1	7.35	0.440	15.2	13 000	15 000	<b>16006</b>	32	53	0.3	0.085
	55	13	1	16.5	8.25	0.530	14.7	13 000	15 000	<b>6006</b>	35	50	1	0.116
	62	16	1	24.3	11.3	0.800	13.9	11 000	13 000	<b>6206</b>	35	57	1	0.199
	62	16	1	29.2	12.8	1.00	13.0	11 000	13 000	<b>6206R</b>	35	57	1	0.212

Single-row deep groove ball bearings  
open type

$d$  (30) ~ (45) mm



$d$  (45) ~ (65) mm

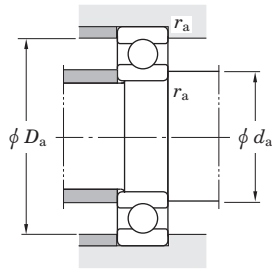
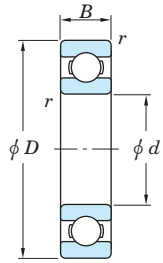
Boundary dimensions (mm)	Basic load ratings (kN)		Fatigue load limit (kN) $C_u$	Factor $f_0$	Limiting speeds ( $\text{min}^{-1}$ )		Mounting dimensions (mm)	(Refer.) Mass (kg)	Bearing No.						
					Grease lub.	Oil lub.									
$d$	$D$	$B$	$r_{\text{min}}$	$C_r$	$C_{0r}$		$d_a$ min.	$D_a$ max.	$r_a$ max.						
<b>30</b>	72	19	1.1	33.3	15.0	1.15	13.3	9 600	12 000	<b>6306</b>	36.5	65.5	1	0.346	
	72	19	1.1	41.7	17.7	1.55	12.0	9 800	12 000	<b>6306R</b>	36.5	65.5	1	0.379	
	90	23	1.5	54.2	23.9	2.05	12.3	8 100	9 700	<b>6406</b>	38	82	1.5	0.735	
<b>32</b>	58	13	1	18.8	9.15	0.600	14.5	12 000	14 000	<b>60/32</b>	37	53	1	0.127	
	65	17	1	29.4	13.1	0.990	13.3	10 000	12 000	<b>62/32</b>	37	60	1	0.228	
	75	20	1.1	37.6	16.2	1.30	12.7	9 300	11 000	<b>63/32</b>	38.5	68.5	1	0.437	
<b>35</b>	47	7	0.3	5.95	3.85	0.160	16.5	13 000	16 000	<b>6807</b>	37	45	0.3	0.030	
	55	10	0.6	13.6	7.75	0.440	15.7	12 000	14 000	<b>6907</b>	39	51	0.6	0.073	
	62	9	0.3	15.3	8.85	0.500	15.7	11 000	13 000	<b>16007</b>	37	60	0.3	0.110	
	62	14	1	19.9	10.3	0.640	14.9	11 000	13 000	<b>6007</b>	40	58	1	0.155	
	72	17	1.1	32.1	15.4	1.10	13.9	9 200	11 000	<b>6207</b>	41.5	65.5	1	0.288	
	72	17	1.1	38.7	17.5	1.40	12.9	9 300	11 000	<b>6207R</b>	41.5	65.5	1	0.309	
	80	21	1.5	41.7	19.3	1.45	13.2	8 500	10 000	<b>6307</b>	43	72	1.5	0.457	
	80	21	1.5	50.0	21.7	1.90	12.1	8 700	10 000	<b>6307R</b>	43	72	1.5	0.494	
	100	25	1.5	68.8	31.0	2.65	12.2	7 200	8 600	<b>6407</b>	43	92	1.5	0.952	
	<b>40</b>	52	7	0.3	6.15	4.20	0.180	16.3	12 000	14 000	<b>6808</b>	42	50	0.3	0.033
62		12	0.6	17.1	9.95	0.570	15.6	11 000	13 000	<b>6908</b>	44	58	0.6	0.112	
68		9	0.3	15.8	9.65	0.530	16.0	9 800	12 000	<b>16008</b>	42	66	0.3	0.125	
68		15	1	20.9	11.5	0.690	15.2	10 000	12 000	<b>6008</b>	45	63	1	0.192	
80		18	1.1	36.4	17.8	1.25	14.0	8 300	10 000	<b>6208</b>	46.5	73.5	1	0.366	
90		23	1.5	50.9	24.0	1.85	13.2	7 700	9 200	<b>6308</b>	48	82	1.5	0.633	
110		27	2	79.6	36.6	3.15	12.3	6 600	7 900	<b>6408</b>	49	101	2	1.23	
<b>45</b>		58	7	0.3	7.75	5.40	0.230	16.3	11 000	13 000	<b>6809</b>	47	56	0.3	0.040
		68	12	0.6	17.7	10.9	0.600	15.9	9 700	11 000	<b>6909</b>	49	64	0.6	0.132
		75	10	0.6	19.4	12.3	0.670	16.0	8 900	10 000	<b>16009</b>	49	71	0.6	0.170
	75	16	1	26.2	15.1	0.900	15.3	9 200	11 000	<b>6009</b>	50	70	1	0.245	
	85	19	1.1	40.9	20.3	1.40	14.0	7 700	9 200	<b>6209</b>	51.5	78.5	1	0.407	
100	25	1.5	61.1	29.5	2.25	13.3	6 800	8 100	<b>6309</b>	53	92	1.5	0.833		

[Remark] Standard cage types used for the above bearings are described earlier in this section.

Boundary dimensions (mm)	Basic load ratings (kN)		Fatigue load limit (kN) $C_u$	Factor $f_0$	Limiting speeds ( $\text{min}^{-1}$ )		Mounting dimensions (mm)	(Refer.) Mass (kg)	Bearing No.						
					Grease lub.	Oil lub.									
$d$	$D$	$B$	$r_{\text{min}}$	$C_r$	$C_{0r}$		$d_a$ min.	$D_a$ max.	$r_a$ max.						
<b>45</b>	120	29	2	96.5	45.1	3.90	12.2	6 000	7 200	<b>6409</b>	54	111	2	1.53	
<b>50</b>	65	7	0.3	8.20	6.10	0.260	16.1	9 600	11 000	<b>6810</b>	52	63	0.3	0.052	
	72	12	0.6	18.2	11.7	0.640	16.1	9 000	11 000	<b>6910</b>	54	68	0.6	0.133	
	80	10	0.6	20.0	13.3	0.710	16.2	8 200	9 700	<b>16010</b>	54	76	0.6	0.180	
	80	16	1	27.3	16.6	0.960	15.6	8 400	9 900	<b>6010</b>	55	75	1	0.261	
	90	20	1.1	43.9	23.3	1.55	14.4	7 100	8 500	<b>6210</b>	56.5	83.5	1	0.463	
	90	20	1.1	50.5	25.5	1.80	13.9	7 100	8 600	<b>6210R</b>	56.5	83.5	1	0.487	
	110	27	2	77.5	38.3	2.90	13.2	6 100	7 300	<b>6310</b>	59	101	2	1.07	
	130	31	2.1	104	49.5	4.10	12.5	5 500	6 600	<b>6410</b>	61	119	2	1.88	
	<b>55</b>	72	9	0.3	11.0	8.10	0.420	16.2	8 700	10 000	<b>6811</b>	57	70	0.3	0.083
		80	13	1	20.8	14.1	0.760	16.2	8 100	9 600	<b>6911</b>	60	75	1	0.185
90		11	0.6	24.2	16.3	0.880	16.2	7 400	8 800	<b>16011</b>	59	86	0.6	0.260	
90		18	1.1	35.3	21.2	1.25	15.3	7 600	8 900	<b>6011</b>	61.5	83.5	1	0.385	
100		21	1.5	54.2	29.4	1.95	14.4	6 300	7 600	<b>6211</b>	63	92	1.5	0.607	
120	29	2	89.5	45.0	3.45	13.2	5 600	6 700	<b>6311</b>	64	111	2	1.37		
140	33	2.1	126	62.3	5.35	12.2	5 000	6 000	<b>6411</b>	66	129	2	2.29		
<b>60</b>	78	10	0.3	14.3	10.6	0.550	16.3	8 000	9 400	<b>6812</b>	62	76	0.3	0.104	
	85	13	1	25.2	17.3	0.940	16.2	7 500	8 900	<b>6912</b>	65	80	1	0.192	
	95	11	0.6	24.8	17.6	0.930	16.4	6 900	8 100	<b>16012</b>	64	91	0.6	0.280	
	95	18	1.1	36.8	23.2	1.35	15.6	7 100	8 400	<b>6012</b>	66.5	88.5	1	0.415	
	110	22	1.5	65.6	36.2	2.40	14.4	5 700	6 900	<b>6212</b>	68	102	1.5	0.783	
	130	31	2.1	102	52.2	3.95	13.2	5 200	6 200	<b>6312</b>	71	119	2	1.70	
	150	35	2.1	137	70.8	5.75	12.4	4 600	5 500	<b>6412</b>	71	139	2	2.77	
<b>65</b>	85	10	0.6	14.9	11.5	0.590	16.2	7 300	8 600	<b>6813</b>	69	81	0.6	0.126	
	90	13	1	21.7	16.1	0.830	16.6	7 100	8 400	<b>6913</b>	70	85	1	0.211	
	100	11	0.6	21.4	16.0	0.830	16.5	6 600	7 800	<b>16013</b>	69	96	0.6	0.300	
	100	18	1.1	38.1	25.2	1.40	15.8	6 600	7 800	<b>6013</b>	71.5	93.5	1	0.435	

Single-row deep groove ball bearings  
open type

$d$  (65) ~ (85) mm



$d$  (85) ~ 105 mm

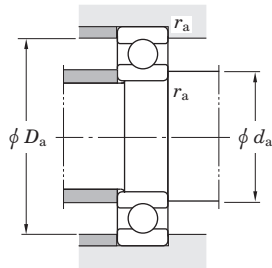
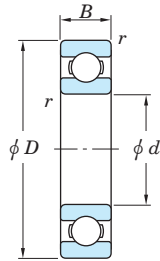
Boundary dimensions (mm)	Basic load ratings (kN)			Fatigue load limit (kN) $C_u$	Factor $f_0$	Limiting speeds ( $\text{min}^{-1}$ )		Mounting dimensions (mm)	(Refer.) Mass (kg)	Bearing No.				
						Grease lub.	Oil lub.				$d_a$ min.	$D_a$ max.	$r_a$ max.	
<b>65</b>	120	23	1.5	71.5	40.1	2.65	14.4	5 400	6 400	<b>6213</b>	73	112	1.5	0.990
	140	33	2.1	116	59.9	4.50	13.2	4 800	5 800	<b>6313</b>	76	129	2	2.08
	160	37	2.1	148	79.2	6.20	12.4	4 300	5 200	<b>6413</b>	76	149	2	3.30
<b>70</b>	90	10	0.6	15.1	11.9	0.620	16.1	6 800	8 100	<b>6814</b>	74	86	0.6	0.134
	100	16	1	29.7	21.2	1.10	16.3	6 400	7 600	<b>6914</b>	75	95	1	0.342
	110	13	0.6	37.6	25.6	1.40	16.0	6 100	7 200	<b>16014</b>	74	106	0.6	0.433
	110	20	1.1	47.6	30.9	1.80	15.6	6 100	7 200	<b>6014</b>	76.5	103.5	1	0.602
	125	24	1.5	77.8	44.1	2.90	14.5	5 100	6 100	<b>6214</b>	78	117	1.5	1.07
	150	35	2.1	130	68.2	4.95	13.2	4 500	5 400	<b>6314</b>	81	139	2	2.52
	180	42	3	181	104	10.2	12.2	3 900	4 600	<b>6414</b>	83	167	2.5	4.83
<b>75</b>	95	10	0.6	15.7	12.9	0.660	16.0	6 400	7 600	<b>6815</b>	79	91	0.6	0.142
	105	16	1	30.5	22.6	1.20	16.5	6 100	7 200	<b>6915</b>	80	100	1	0.363
	115	13	0.6	34.4	25.3	1.35	16.4	5 700	6 700	<b>16015</b>	79	111	0.6	0.457
	115	20	1.1	49.4	33.5	1.90	15.8	5 700	6 800	<b>6015</b>	81.5	108.5	1	0.638
	130	25	1.5	84.3	48.3	3.10	14.5	4 800	5 800	<b>6215</b>	83	122	1.5	1.18
	160	37	2.1	142	77.2	5.40	13.2	4 200	5 000	<b>6315</b>	86	149	2	3.02
	190	45	3	192	115	10.9	12.3	3 600	4 400	<b>6415</b>	88	177	2.5	5.87
<b>80</b>	100	10	0.6	15.9	13.3	0.690	16.0	6 100	7 200	<b>6816</b>	84	96	0.6	0.150
	110	16	1	31.2	24.0	1.25	16.6	5 700	6 800	<b>6916</b>	85	105	1	0.382
	125	14	0.6	39.7	29.7	1.50	16.4	5 200	6 100	<b>16016</b>	84	121	0.6	0.597
	125	22	1.1	59.5	39.8	2.25	15.6	5 300	6 300	<b>6016</b>	86.5	118.5	1	0.850
	140	26	2	90.9	53.0	3.25	14.6	4 500	5 400	<b>6216</b>	89	131	2	1.40
	170	39	2.1	154	86.7	5.85	13.3	3 900	4 700	<b>6316</b>	91	159	2	3.59
	200	48	3	205	125	11.5	12.3	3 400	4 100	<b>6416</b>	93	187	2.5	6.84
<b>85</b>	110	13	1	23.4	19.0	0.980	16.2	5 600	6 600	<b>6817</b>	90	105	1	0.266
	120	18	1.1	39.9	29.6	1.55	16.4	5 300	6 300	<b>6917</b>	91.5	113.5	1	0.535
	130	14	0.6	40.8	31.7	1.55	16.5	4 900	5 800	<b>16017</b>	89	126	0.6	0.626

[Remark] Standard cage types used for the above bearings are described earlier in this section.

Boundary dimensions (mm)	Basic load ratings (kN)			Fatigue load limit (kN) $C_u$	Factor $f_0$	Limiting speeds ( $\text{min}^{-1}$ )		Mounting dimensions (mm)	(Refer.) Mass (kg)	Bearing No.				
						Grease lub.	Oil lub.				$d_a$ min.	$D_a$ max.	$r_a$ max.	
<b>85</b>	130	22	1.1	61.8	43.1	2.35	15.8	5 000	5 900	<b>6017</b>	91.5	123.5	1	0.890
	150	28	2	105	61.9	3.70	14.5	4 200	5 000	<b>6217</b>	94	141	2	1.79
	180	41	3	166	96.8	6.35	13.3	3 700	4 400	<b>6317</b>	98	167	2.5	4.23
	210	52	4	217	136	12.2	12.3	3 300	3 900	<b>6417</b>	101	194	3	8.07
<b>90</b>	115	13	1	23.8	19.7	1.00	16.1	5 300	6 300	<b>6818</b>	95	110	1	0.279
	125	18	1.1	41.0	31.6	1.60	16.5	5 100	6 000	<b>6918</b>	96.5	118.5	1	0.565
	140	16	1	49.9	37.0	1.85	16.3	4 700	5 600	<b>16018</b>	95	135	1	0.848
	140	24	1.5	72.8	49.7	2.65	15.6	4 700	5 600	<b>6018</b>	98	132	1.5	1.16
	160	30	2	120	71.5	4.20	14.5	3 900	4 700	<b>6218</b>	99	151	2	2.15
	190	43	3	178	107	8.80	13.3	3 500	4 200	<b>6318</b>	103	177	2.5	4.91
	225	54	4	230	149	12.7	12.5	3 100	3 700	<b>6418</b>	106	209	3	9.78
<b>95</b>	130	18	1.1	42.1	33.5	1.65	16.6	4 800	5 700	<b>6919</b>	101.5	123.5	1	0.705
	145	16	1	51.5	39.6	1.90	16.4	4 500	5 300	<b>16019</b>	100	140	1	0.885
	145	24	1.5	75.5	53.9	2.75	15.8	4 400	5 200	<b>6019</b>	103	137	1.5	1.21
	170	32	2.1	136	81.9	4.65	14.4	3 700	4 400	<b>6219</b>	106	159	2	2.62
200	45	3	191	119	9.45	13.3	3 300	4 000	<b>6319</b>	108	187	2.5	5.67	
<b>100</b>	125	13	1	24.5	21.2	1.05	16.0	4 800	5 700	<b>6820</b>	105	120	1	0.309
	140	20	1.1	56.2	41.9	2.05	16.2	4 500	5 300	<b>6920</b>	106.5	133.5	1	0.960
	150	16	1	53.0	42.1	1.95	16.5	4 300	5 100	<b>16020</b>	105	145	1	0.910
	150	24	1.5	75.2	54.2	2.70	15.9	4 300	5 100	<b>6020</b>	108	142	1.5	1.25
	180	34	2.1	153	93.1	5.15	14.4	3 500	4 200	<b>6220</b>	111	169	2	3.14
	215	47	3	216	141	10.9	13.2	3 000	3 600	<b>6320</b>	113	202	2.5	7.00
<b>105</b>	145	20	1.1	58.1	44.8	2.10	16.4	4 300	5 100	<b>6921</b>	111.5	138.5	1	1.00
	160	18	1	52.3	42.2	1.90	16.5	4 100	4 800	<b>16021</b>	110	155	1	1.20
	160	26	2	90.4	65.8	3.20	15.8	4 000	4 700	<b>6021</b>	114	151	2	1.59
	190	36	2.1	166	105	5.70	14.4	3 300	3 900	<b>6221</b>	116	179	2	3.70
	225	49	3	230	153	11.7	13.2	2 900	3 500	<b>6321</b>	118	212	2.5	8.05

Single-row deep groove ball bearings  
open type

$d$  110 ~ (150) mm



$d$  (150) ~ (200) mm

Boundary dimensions (mm)	Basic load ratings (kN)		Fatigue load limit (kN) $C_u$	Factor $f_0$	Limiting speeds ( $\text{min}^{-1}$ )		Mounting dimensions (mm)	(Refer.) Mass (kg)	Bearing No.					
					Grease lub.	Oil lub.				$d_a$ min.	$D_a$ max.	$r_a$ max.		
<b>110</b>	140	16	1	35.1	30.7	1.40	16.1	4 300	5 100	<b>6822</b>	115	135	1	0.606
	150	20	1.1	59.9	47.8	2.20	16.4	4 100	4 900	<b>6922</b>	116.5	143.5	1	1.04
	170	19	1	71.8	56.7	2.55	16.3	3 800	4 500	<b>16022</b>	115	165	1	1.46
	170	28	2	103	73.0	3.55	15.6	3 800	4 500	<b>6022</b>	119	161	2	1.96
	200	38	2.1	180	117	6.20	14.4	3 100	3 700	<b>6222</b>	121	189	2	4.36
	240	50	3	257	180	13.3	13.2	2 700	3 200	<b>6322</b>	123	227	2.5	9.54
<b>120</b>	150	16	1	36.2	33.0	1.45	16.0	4 000	4 700	<b>6824</b>	125	145	1	0.655
	165	22	1.1	71.6	56.9	2.50	16.4	3 800	4 400	<b>6924</b>	126.5	158.5	1	1.41
	180	19	1	79.0	63.3	2.75	16.4	3 600	4 200	<b>16024</b>	125	175	1	1.80
	180	28	2	106	79.3	3.60	15.9	3 600	4 200	<b>6024</b>	129	171	2	2.07
	215	40	2.1	194	131	6.65	14.4	2 900	3 400	<b>6224</b>	131	204	2	5.15
	260	55	3	258	185	12.6	13.5	2 500	3 000	<b>6324</b>	133	247	2.5	12.5
<b>130</b>	165	18	1.1	46.1	41.2	1.75	16.1	3 600	4 300	<b>6826</b>	136.5	158.5	1	0.939
	180	24	1.5	86.9	67.4	3.00	16.3	3 400	4 100	<b>6926</b>	138	172	1.5	1.86
	200	22	1.1	89.1	74.8	3.05	11.2	3 000	3 600	<b>16026</b>	136.5	193.5	1	2.69
	200	33	2	133	101	4.45	15.8	3 200	3 800	<b>6026</b>	139	191	2	3.16
	230	40	3	209	146	9.15	14.5	2 700	3 200	<b>6226</b>	143	217	2.5	5.82
	280	58	4	287	214	14.1	13.6	2 300	2 700	<b>6326</b>	146	264	3	15.1
<b>140</b>	175	18	1.1	47.8	44.4	1.85	16.0	3 400	4 000	<b>6828</b>	146.5	168.5	1	1.00
	190	24	1.5	89.1	74.8	3.05	16.5	3 200	3 800	<b>6928</b>	148	182	1.5	1.98
	210	22	1.1	82.2	71.1	2.80	16.5	2 900	3 400	<b>16028</b>	146.5	203.5	1	2.86
	210	33	2	137	109	4.55	15.9	3 000	3 600	<b>6028</b>	149	201	2	3.55
	250	42	3	208	150	8.65	14.8	2 400	2 900	<b>6228</b>	153	237	2.5	7.45
	300	62	4	316	246	15.6	13.6	2 100	2 500	<b>6328</b>	156	284	3	19.4
<b>150</b>	190	20	1.1	59.7	54.9	2.20	16.1	3 100	3 700	<b>6830</b>	156.5	183.5	1	1.40
	210	28	2	117	94.3	3.75	16.2	2 900	3 400	<b>6930</b>	159	201	2	3.05
	225	24	1.1	114	99.3	3.70	16.6	2 700	3 100	<b>16030</b>	156.5	218.5	1	3.58
	225	35	2.1	157	126	5.10	16.0	2 800	3 300	<b>6030</b>	161	214	2	4.22

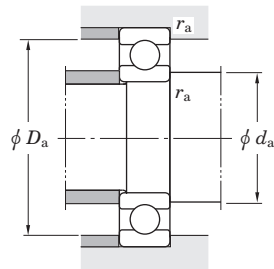
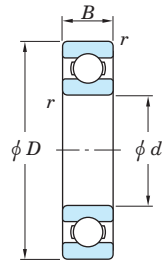
[Remark] Standard cage types used for the above bearings are described earlier in this section.

Boundary dimensions (mm)	Basic load ratings (kN)		Fatigue load limit (kN) $C_u$	Factor $f_0$	Limiting speeds ( $\text{min}^{-1}$ )		Mounting dimensions (mm)	(Refer.) Mass (kg)	Bearing No.					
					Grease lub.	Oil lub.				$d_a$ min.	$D_a$ max.	$r_a$ max.		
<b>150</b>	270	45	3	220	168	9.05	15.1	2 200	2 700	<b>6230</b>	163	257	2.5	9.41
	320	65	4	343	284	16.6	13.9	1 900	2 300	<b>6330</b>	166	304	3	26.2
<b>160</b>	200	20	1.1	60.5	56.9	2.20	16.1	2 900	3 400	<b>6832</b>	166.5	193.5	1	1.45
	220	28	2	120	101	3.85	16.4	2 700	3 200	<b>6932</b>	169	211	2	3.20
	240	25	1.5	124	108	3.95	16.5	2 600	3 100	<b>16032</b>	168	232	1.5	4.25
	240	38	2.1	171	135	5.30	15.9	2 600	3 000	<b>6032</b>	171	229	2	5.22
	290	48	3	231	186	9.45	15.4	2 100	2 500	<b>6232</b>	173	277	2.5	14.3
	340	68	4	347	286	16.4	13.9	1 800	2 200	<b>6332</b>	176	324	3	29.0
<b>170</b>	215	22	1.1	74.8	70.5	2.60	16.1	2 700	3 200	<b>6834</b>	176.5	208.5	1	1.90
	230	28	2	124	108	3.95	16.5	2 600	3 100	<b>6934</b>	179	221	2	3.35
	260	28	1.5	142	127	4.45	16.5	2 300	2 700	<b>16034</b>	178	252	1.5	5.75
	260	42	2.1	201	161	6.20	15.8	2 400	2 800	<b>6034</b>	181	249	2	6.80
	310	52	4	265	223	11.1	15.3	1 900	2 300	<b>6234</b>	186	294	3	17.5
	360	72	4	408	355	20.5	13.6	1 700	2 000	<b>6334</b>	186	344	3	38.6
<b>180</b>	225	22	1.1	75.8	73.1	2.65	16.1	2 600	3 000	<b>6836</b>	186.5	218.5	1	2.00
	250	33	2	153	129	4.70	16.3	2 400	2 800	<b>6936</b>	189	241	2	4.90
	280	31	2	169	148	5.15	16.4	2 100	2 500	<b>16036</b>	189	271	2	7.55
	280	46	2.1	227	194	7.15	15.8	2 200	2 600	<b>6036</b>	191	269	2	10.3
	320	52	4	284	241	12.0	15.1	1 800	2 200	<b>6236</b>	196	304	3	18.3
	380	75	4	443	407	22.1	13.9	1 600	1 900	<b>6336</b>	196	364	3	44.7
<b>190</b>	240	24	1.5	91.4	88.1	3.10	16.1	2 400	2 800	<b>6838</b>	198	232	1.5	2.60
	260	33	2	158	138	4.85	16.4	2 300	2 700	<b>6938</b>	199	251	2	5.20
	290	31	2	173	158	5.20	16.6	2 000	2 400	<b>16038</b>	199	281	2	7.85
	290	46	2.1	235	201	7.35	15.8	2 100	2 500	<b>6038</b>	201	279	2	10.8
	340	55	4	319	281	13.7	15.0	1 700	2 000	<b>6238</b>	206	324	3	23.0
	400	78	5	443	415	21.3	14.1	1 500	1 800	<b>6338</b>	210	380	4	51.5
<b>200</b>	250	24	1.5	97.6	93.6	3.20	16.1	2 300	2 700	<b>6840</b>	208	242	1.5	2.70



Single-row deep groove ball bearings  
open type

$d$  (200) ~ (280) mm



$d$  (280) ~ (380) mm

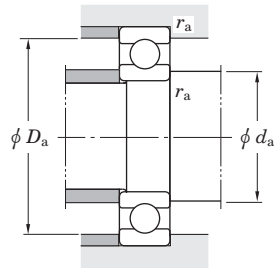
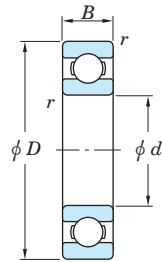
Boundary dimensions (mm)	Basic load ratings (kN)		Fatigue load limit (kN) $C_u$	Factor $f_0$	Limiting speeds ( $\text{min}^{-1}$ )		Bearing No.	Mounting dimensions (mm)			(Refer.) Mass (kg)			
					Grease lub.	Oil lub.		$d_a$ min.	$D_a$ max.	$r_a$ max.				
$d$	$D$	$B$	$r_{\text{min}}$	$C_r$	$C_{0r}$									
<b>200</b>	280	38	2.1	196	168	5.80	16.2	2 100	2 500	<b>6940</b>	211	269	2	7.30
	310	34	2	201	180	5.95	16.4	1 900	2 300	<b>16040</b>	209	301	2	10.1
	310	51	2.1	272	243	11.3	15.6	1 900	2 300	<b>6040</b>	211	299	2	14.0
	360	58	4	336	311	14.4	15.2	1 600	1 900	<b>6240</b>	216	344	3	28.2
	420	80	5	513	506	25.5	14.0	1 300	1 600	<b>6340</b>	220	400	4	58.0
<b>220</b>	270	24	1.5	101	101	3.35	16.0	2 000	2 400	<b>6844</b>	228	262	1.5	3.00
	300	38	2.1	201	180	5.85	16.4	1 900	2 200	<b>6944</b>	231	289	2	7.90
	340	37	2.1	225	217	6.65	16.5	1 700	2 000	<b>16044</b>	231	329	2	13.2
	340	56	3	294	271	12.0	15.6	1 700	2 000	<b>6044</b>	233	327	2.5	18.3
	400	65	4	389	376	16.8	15.1	1 400	1 700	<b>6244</b>	236	384	3	37.0
	460	88	5	542	539	26.7	13.8	1 200	1 500	<b>6344</b>	240	440	4	71.6
<b>240</b>	300	28	2	135	135	4.25	16.1	1 800	2 100	<b>6848</b>	249	291	2	4.50
	320	38	2.1	205	192	5.95	16.5	1 700	2 000	<b>6948</b>	251	309	2	8.50
	360	37	2.1	230	228	6.75	16.5	1 600	1 800	<b>16048</b>	251	349	2	14.1
	360	56	3	305	296	12.3	15.9	1 600	1 900	<b>6048</b>	253	347	2.5	19.7
	440	72	4	424	431	18.2	15.2	1 200	1 500	<b>6248</b>	256	424	3	51.0
	500	95	5	587	624	28.2	14.2	1 100	1 300	<b>6348</b>	260	480	4	93.3
<b>260</b>	320	28	2	141	146	4.40	16.0	1 700	2 000	<b>6852</b>	269	311	2	4.80
	360	46	2.1	266	263	10.2	16.3	1 500	1 800	<b>6952</b>	271	349	2	14.4
	400	44	3	295	310	11.5	16.4	1 400	1 600	<b>16052</b>	273	387	2.5	21.6
	400	65	4	364	377	15.0	15.8	1 400	1 700	<b>6052</b>	276	384	3	29.3
	480	80	5	502	541	22.2	15.1	1 100	1 300	<b>6252</b>	280	460	4	68.2
	540	102	6	663	741	32.4	14.2	990	1 200	<b>6352</b>	284	516	5	116
<b>280</b>	350	33	2	179	183	5.35	16.1	1 500	1 800	<b>6856</b>	289	341	2	7.40
	380	46	2.1	273	283	10.5	16.5	1 400	1 700	<b>6956</b>	291	369	2	15.1
	420	44	3	302	331	11.7	14.7	1 300	1 500	<b>16056</b>	293	407	2.5	22.9
	420	65	4	377	408	15.5	16.0	1 300	1 500	<b>6056</b>	296	404	3	31.0
	500	80	5	529	599	23.2	15.3	1 000	1 200	<b>6256</b>	300	480	4	71.8

[Remark] Standard cage types used for the above bearings are described earlier in this section.

Boundary dimensions (mm)	Basic load ratings (kN)		Fatigue load limit (kN) $C_u$	Factor $f_0$	Limiting speeds ( $\text{min}^{-1}$ )		Bearing No.	Mounting dimensions (mm)			(Refer.) Mass (kg)			
					Grease lub.	Oil lub.		$d_a$ min.	$D_a$ max.	$r_a$ max.				
$d$	$D$	$B$	$r_{\text{min}}$	$C_r$	$C_{0r}$									
<b>280</b>	580	108	6	711	845	33.9	14.5	880	1 100	<b>6356</b>	304	556	5	145
	<b>300</b>	380	38	2.1	224	230	6.45	16.2	1 400	1 600	<b>6860</b>	311	369	2
420		56	3	345	377	13.7	16.2	1 300	1 500	<b>6960</b>	313	407	2.5	24.1
460		50	4	355	405	14.0	16.4	1 100	1 400	<b>16060</b>	316	447	3	32.2
460		74	4	444	482	18.4	15.6	1 200	1 400	<b>6060</b>	316	444	3	44.0
540		85	5	551	663	23.5	15.6	880	1 100	<b>6260</b>	320	520	4	89.5
620		109	7.5	741	886	35.0	14.4	810	970	<b>6360</b>	332	588	6	169
<b>320</b>	400	38	2.1	227	239	6.50	16.1	1 300	1 500	<b>6864</b>	331	389	2	11.0
	440	56	3	356	404	14.1	16.4	1 200	1 400	<b>6964</b>	333	427	2.5	25.5
	480	50	4	364	432	14.3	16.5	1 100	1 300	<b>16064</b>	336	467	3	33.9
	480	74	4	441	487	17.8	15.7	1 100	1 300	<b>6064</b>	336	464	3	46.0
	580	92	5	612	745	26.7	15.4	840	1 000	<b>6264</b>	340	560	4	113
	670	112	7.5	793	1 010	36.9	14.8	720	870	<b>6364</b>	352	638	6	207
<b>340</b>	420	38	2.1	231	249	6.60	16.1	1 200	1 400	<b>6868</b>	351	409	2	11.5
	460	56	3	352	407	13.7	16.5	1 100	1 300	<b>6968</b>	353	447	2.5	26.8
	520	57	4	419	512	16.8	16.4	980	1 200	<b>16068</b>	356	507	3	46.8
	520	82	5	552	661	23.7	15.6	980	1 200	<b>6068</b>	360	500	4	61.8
	620	92	6	639	817	27.7	15.6	760	910	<b>6268</b>	364	596	5	131
	710	118	7.5	880	1 160	41.7	14.7	660	790	<b>6368</b>	372	678	6	238
<b>360</b>	440	38	2.1	240	268	6.95	16.0	1 100	1 300	<b>6872</b>	371	429	2	12.0
	480	56	3	362	432	14.0	16.5	1 000	1 200	<b>6972</b>	373	467	2.5	28.2
	540	57	4	431	546	17.2	16.5	900	1 100	<b>16072</b>	376	527	3	49.0
	540	82	5	548	668	23.0	15.7	920	1 100	<b>6072</b>	380	520	4	64.7
	650	95	6	696	904	30.4	15.4	700	840	<b>6272</b>	384	626	5	144
	<b>380</b>	480	46	2.1	305	359	8.95	16.2	980	1 200	<b>6876</b>	391	469	2
520		65	4	440	552	17.6	16.4	920	1 100	<b>6976</b>	396	504	3	40.8
560		82	5	572	725	24.1	15.9	860	1 000	<b>6076</b>	400	540	4	67.6

# Single-row deep groove ball bearings open type

$d$  (380) ~ 500 mm



Boundary dimensions (mm)	Basic load ratings (kN)		Fatigue load limit (kN) $C_u$	Factor $f_0$	Limiting speeds ( $\text{min}^{-1}$ )		Bearing No.	Mounting dimensions (mm)			(Refer.) Mass (kg)			
					Grease lub.	Oil lub.		$d_a$ min.	$D_a$ max.	$r_a$ max.				
$d$	$D$	$B$	$r$ min.	$C_r$	$C_{0r}$									
<b>380</b>	680	95	6	730	990	31.9	15.6	650	780	<b>6276</b>	404	656	5	162
<b>400</b>	500	46	2.1	311	374	9.10	16.1	920	1 100	<b>6880</b>	411	489	2	20.5
	540	65	4	453	588	18.1	16.5	860	1 000	<b>6980</b>	416	524	3	42.7
	600	63	5	447	587	17.5	16.5	780	920	<b>16080</b>	420	580	4	65.0
	600	90	5	635	824	27.0	15.7	780	920	<b>6080</b>	420	580	4	87.7
	720	103	6	785	1 080	34.2	15.5	590	710	<b>6280</b>	424	696	5	197
<b>420</b>	520	46	2.1	316	389	9.25	16.1	860	1 000	<b>6884</b>	431	509	2	21.5
	560	65	4	449	588	17.7	16.5	810	950	<b>6984</b>	436	544	3	43.5
	620	63	5	459	617	18.0	16.4	740	870	<b>16084</b>	440	600	4	69.9
	620	90	5	663	894	28.3	15.8	740	870	<b>6084</b>	440	600	4	91.2
<b>440</b>	540	46	2.1	321	404	9.40	16.0	810	950	<b>6888</b>	451	529	2	22.5
	600	74	4	529	676	21.4	16.4	740	870	<b>6988</b>	456	584	3	61.3
	650	67	5	508	710	20.2	16.5	680	810	<b>16088</b>	460	630	4	81.7
<b>460</b>	580	56	3	393	517	11.7	16.2	740	870	<b>6892</b>	473	567	2.5	35.0
	620	74	4	509	711	20.3	16.5	690	820	<b>6992</b>	476	604	3	61.7
	680	71	5	539	767	21.4	16.5	630	750	<b>16092</b>	480	660	4	91.2
<b>480</b>	600	56	3	401	539	12.0	16.1	690	820	<b>6896</b>	493	587	2.5	36.5
	650	78	5	540	768	21.5	16.5	640	760	<b>6996</b>	500	630	4	72.5
	700	71	5	554	807	22.1	16.5	600	710	<b>16096</b>	500	680	4	98.5
<b>500</b>	620	56	3	409	561	12.2	16.1	650	770	<b>68/500</b>	513	607	2.5	37.5
	670	78	5	556	807	22.2	16.5	610	720	<b>69/500</b>	520	650	4	75.2
	720	71	5	568	846	22.7	16.4	560	660	<b>160/500</b>	520	700	4	102
	720	100	6	749	1 100	31.3	16.0	570	670	<b>60/500</b>	524	696	5	128

[Remark] Standard cage types used for the above bearings are described earlier in this section.

Single-row deep groove ball bearings  
shielded type  
sealed type

d 10 ~ (22) mm

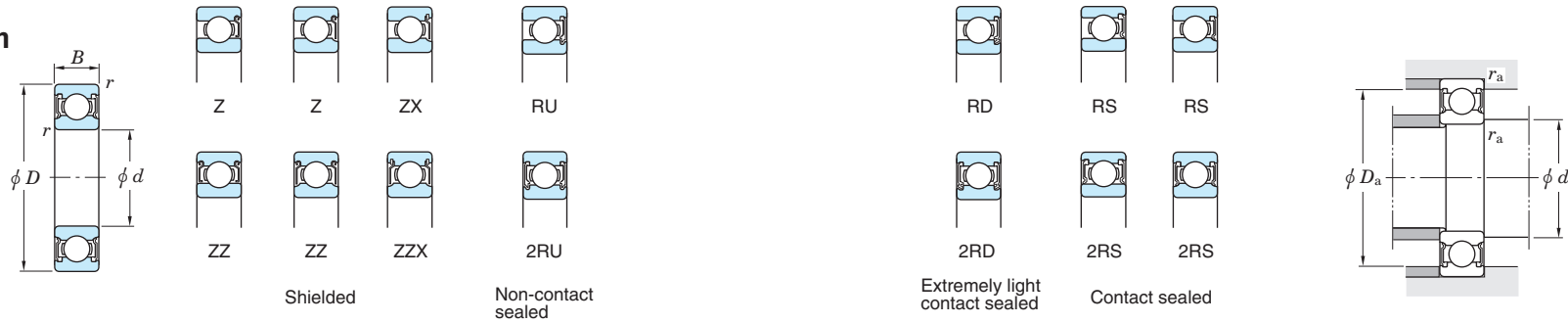


Boundary dimensions (mm)				Basic load ratings (kN)		Fatigue load limit (kN) $C_u$	Factor $f_0$	Limiting speeds ( $\text{min}^{-1}$ )				Bearing No.	Mounting dimensions (mm)				(Refer.) Mass Open type (kg)			
$d$	$D$	$B$	$r_{\text{min}}$	$C_r$	$C_{0r}$			Grease lub.		Oil lub.			Shielded	Non-contact sealed	Extremely light contact sealed	Contact sealed		$d_a$ min.	$d_a$ max.	$D_a$ max.
10	19	5	0.3	2.15	0.84	0.030	14.8	37 000	—	22 000	43 000	6800 ZZ	6800 2RU	—	6800 2RS	12	12	17	0.3	0.005
	22	6	0.3	3.35	1.25	0.070	14.0	34 000	—	21 000	41 000	6900 ZZ	6900 2RU	—	6900 2RS	12	12.5	20	0.3	0.010
	26	8	0.3	5.70	1.95	0.100	12.3	31 000	28 000	19 000	36 000	6000 ZZ	6000 2RU	6000 2RD	6000 2RS	12	13	24	0.3	0.019
	30	9	0.6	6.40	2.40	0.120	13.2	24 000	22 000	16 000	29 000	6200 ZZ	6200 2RU	6200 2RD	6200 2RS	14	15	26	0.6	0.032
	35	11	0.6	10.1	3.45	0.270	11.2	22 000	20 000	16 000	27 000	6300 ZZ	6300 2RU	6300 2RD	6300 2RS	14	16	31	0.6	0.053
12	21	5	0.3	2.40	1.05	0.040	15.3	33 000	30 000	20 000	39 000	6801 ZZ	6801 2RU	6801 2RD	6801 2RS	14	14	19	0.3	0.006
	24	6	0.3	3.60	1.45	0.080	14.5	31 000	28 000	18 000	36 000	6901 ZZ	6901 2RU	6901 2RD	6901 2RS	14	14	22	0.3	0.011
	28	8	0.3	6.40	2.40	0.120	13.2	27 000	24 000	17 000	32 000	6001 ZZ	6001 2RU	6001 2RD	6001 2RS	14	15	26	0.3	0.022
	32	10	0.6	8.50	3.05	0.240	12.3	22 000	20 000	15 000	27 000	6201 ZZ	6201 2RU	6201 2RD	6201 2RS	16	16.5	28	0.6	0.037
	37	12	1	12.1	4.20	0.420	11.1	20 000	18 000	15 000	25 000	6301 ZZ	6301 2RU	6301 2RD	6301 2RS	17	17.5	32	1	0.060
15	24	5	0.3	2.60	1.25	0.050	15.8	28 000	—	16 000	33 000	6802 ZZ	6802 2RU	—	6802 2RS	17	17	22	0.3	0.007
	28	7	0.3	5.40	2.25	0.120	14.3	26 000	23 000	15 000	30 000	6902 ZZ	6902 2RU	6902 2RD	6902 2RS	17	18	26	0.3	0.017
	32	9	0.3	7.00	2.85	0.150	13.9	23 000	21 000	14 000	27 000	6002 ZZ	6002 2RU	6002 2RD	6002 2RS	17	18.5	30	0.3	0.030
	35	11	0.6	9.55	3.75	0.290	13.2	20 000	18 000	13 000	24 000	6202 ZZ	6202 2RU	6202 2RD	6202 2RS	19	19.5	31	0.6	0.045
	42	13	1	14.3	5.45	0.460	12.3	17 000	15 000	12 000	20 000	6302 ZZ	6302 2RU	6302 2RD	6302 2RS	20	21.5	37	1	0.082
17	26	5	0.3	3.30	1.55	0.060	15.7	26 000	—	14 000	30 000	6803 ZZ	6803 2RU	—	6803 2RS	19	19	24	0.3	0.008
	30	7	0.3	5.75	2.55	0.130	14.7	23 000	21 000	13 000	28 000	6903 ZZ	6903 2RU	6903 2RD	6903 2RS	19	19.5	28	0.3	0.018
	35	10	0.3	7.50	3.25	0.170	14.4	21 000	19 000	12 000	25 000	6003 ZZ	6003 2RU	6003 2RD	6003 2RS	19	21	33	0.3	0.039
	40	12	0.6	12.0	4.80	0.370	13.2	17 000	15 000	12 000	21 000	6203 ZZ	6203 2RU	6203 2RD	6203 2RS	21	22	36	0.6	0.065
	47	14	1	17.0	6.65	0.550	12.4	15 000	14 000	10 000	18 000	6303 ZZ	6303 2RU	6303 2RD	6303 2RS	22	24.3	42	1	0.115
20	32	7	0.3	5.00	2.45	0.100	15.5	21 000	—	12 000	25 000	6804 ZZ	6804 2RU	—	6804 2RS	22	22.5	30	0.3	0.018
	37	9	0.3	7.95	3.70	0.190	14.7	19 000	17 000	11 000	23 000	6904 ZZ	6904 2RU	6904 2RD	6904 2RS	22	23.5	35	0.3	0.036
	42	12	0.6	11.7	5.05	0.350	13.9	17 000	15 000	10 000	21 000	6004 ZZ	6004 2RU	6004 2RD	6004 2RS	24	25	38	0.6	0.069
	47	14	1	16.0	6.65	0.510	13.2	15 000	14 000	9 700	17 000	6204 ZZ	6204 2RU	6204 2RD	6204 2RS	25	26.5	42	1	0.106
	52	15	1.1	19.9	7.85	0.660	12.3	14 000	13 000	9 500	17 000	6304 ZZ	6304 2RU	6304 2RD	6304 2RS	26.5	27	45.5	1	0.144
22	44	12	0.6	11.7	5.15	0.350	14.1	17 000	15 000	9 900	20 000	60/22 ZZ	60/22 2RU	60/22 2RD	60/22 2RS	26	26.5	40	0.6	0.073
	50	14	1	16.0	6.65	0.510	13.2	15 000	14 000	9 700	17 000	62/22 ZZ	62/22 2RU	62/22 2RD	62/22 2RS	27	27	45	1	0.118

[Remark] Standard cage types used for the above bearings are described earlier in this section.

Single-row deep groove ball bearings  
shielded type  
sealed type

d (22) ~ 40 mm



Boundary dimensions (mm)				Basic load ratings (kN)		Fatigue load limit (kN) <i>C<sub>u</sub></i>	Factor <i>f<sub>0</sub></i>	Limiting speeds (min <sup>-1</sup> )			Oil lub. (Z)	Bearing No.				Mounting dimensions (mm)				(Refer. Mass Open type (kg))
<i>d</i>	<i>D</i>	<i>B</i>	<i>r</i> <sub>min.</sub>	<i>C<sub>r</sub></i>	<i>C<sub>0r</sub></i>			Grease lub.		[ Z ZZ ] (RU, 2RU)		(RD, 2RD)	(RS, 2RS)	Shielded	Non-contact sealed	Extremely light contact sealed	Contact sealed	<i>d<sub>a</sub></i> min.	<i>d<sub>a</sub></i> max.	
22	56	16	1.1	23.1	9.40	0.770	12.6	13 000	12 000		8 600			15 000	63/22 ZZ	63/22 2RU	63/22 2RD	63/22 2RS	28.5	29
25	37	7	0.3	5.40	2.95	0.120	16.0	18 000	—	10 000	21 000	6805 ZZ	6805 2RU	—	6805 2RS	27	27.5	35	0.3	0.022
	42	9	0.3	8.75	4.55	0.230	15.4	16 000	14 000	9 300	19 000	6905 ZZ	6905 2RU	6905 2RD	6905 2RS	27	29	40	0.3	0.041
	47	12	0.6	12.6	5.85	0.380	14.5	15 000	14 000	9 000	18 000	6005 ZZ	6005 2RU	6005 2RD	6005 2RS	29	29.5	43	0.6	0.080
	52	15	1	17.5	7.85	0.550	13.9	13 000	12 000	8 400	15 000	6205 ZZ	6205 2RU	6205 2RD	6205 2RS	30	31.5	47	1	0.128
	62	17	1.1	25.7	11.3	0.860	13.2	11 000	9 900	7 500	13 000	6305 ZZ	6305 2RU	6305 2RD	6305 2RS	31.5	34	55.5	1	0.232
28	52	12	0.6	15.6	7.40	0.480	14.5	14 000	13 000	8 100	16 000	60/28 ZZ	60/28 2RU	60/28 2RD	60/28 2RS1	32	33	48	0.6	0.097
	58	16	1	22.4	9.75	0.720	13.4	12 000	11 000	7 600	14 000	62/28 ZZ	62/28 2RU	62/28 2RD	62/28 2RS	33	35	53	1	0.173
	68	18	1.1	29.4	13.1	0.990	13.3	10 000	9 000	6 900	12 000	63/28 ZZ	63/28 2RU	63/28 2RD	63/28 2RS	34.5	37.5	61.5	1	0.328
30	42	7	0.3	5.65	3.40	0.140	16.4	15 000	—	8 600	18 000	6806 ZZ	6806 2RU	—	6806 2RS	32	32.5	40	0.3	0.026
	47	9	0.3	9.05	5.00	0.260	15.8	14 000	13 000	8 200	17 000	6906 ZZ	6906 2RU	6906 2RD	6906 2RS	32	33	45	0.3	0.045
	55	13	1	16.5	8.25	0.530	14.7	13 000	12 000	7 500	15 000	6006 ZZ	6006 2RU	6006 2RD	6006 2RS	35	36	50	1	0.116
	62	16	1	24.3	11.3	0.800	13.9	11 000	9 900	7 000	13 000	6206 ZZ	6206 2RU	6206 2RD	6206 2RS	35	37.5	57	1	0.199
	72	19	1.1	33.3	15.0	1.15	13.3	9 600	8 600	6 400	12 000	6306 ZZ	6306 2RU	6306 2RD	6306 2RS	36.5	40	65.5	1	0.346
32	58	13	1	18.8	9.15	0.600	14.5	12 000	11 000	7 200	14 000	60/32 ZZ	60/32 2RU	60/32 2RD	60/32 2RS	37	38	53	1	0.127
	65	17	1	29.4	13.1	0.990	13.3	10 000	9 000	6 900	12 000	62/32 ZZ	62/32 2RU	62/32 2RD	62/32 2RS	37	38.5	60	1	0.228
	75	20	1.1	37.6	16.2	1.30	12.7	9 300	8 400	6 400	11 000	63/32 ZZ	63/32 2RU	63/32 2RD	63/32 2RS	38.5	41	68.5	1	0.437
35	47	7	0.3	5.95	3.85	0.160	16.5	13 000	—	7 400	16 000	6807 ZZ	6807 2RU	—	6807 2RS	37	37.5	45	0.3	0.030
	55	10	0.6	13.6	7.75	0.440	15.7	12 000	11 000	6 800	14 000	6907 ZZ	6907 2RU	6907 2RD	6907 2RS	39	40	51	0.6	0.073
	62	14	1	19.9	10.3	0.640	14.9	11 000	9 900	6 500	13 000	6007 ZZ	6007 2RU	6007 2RD	6007 2RS	40	42	58	1	0.155
	72	17	1.1	32.1	15.4	1.10	13.9	9 200	8 300	6 000	11 000	6207 ZZ	6207 2RU	6207 2RD	6207 2RS	41.5	43.5	65.5	1	0.288
	80	21	1.5	41.7	19.3	1.45	13.2	8 500	7 700	5 700	10 000	6307 ZZ	6307 2RU	6307 2RD	6307 2RS	43	46	72	1.5	0.457
40	52	7	0.3	6.15	4.20	0.180	16.3	12 000	11 000	6 700	14 000	6808 ZZ	6808 2RU	6808 2RD	6808 2RS	42	42	50	0.3	0.033
	62	12	0.6	17.1	9.95	0.570	15.6	11 000	9 900	6 100	13 000	6908 ZZ	6908 2RU	6908 2RD	6908 2RS	44	44.5	58	0.6	0.112
	68	15	1	20.9	11.5	0.690	15.2	10 000	9 000	5 800	12 000	6008 ZZ	6008 2RU	6008 2RD	6008 2RS	45	46.5	63	1	0.192
	80	18	1.1	36.4	17.8	1.25	14.0	8 300	7 500	5 400	10 000	6208 ZZ	6208 2RU	6208 2RD	6208 2RS	46.5	49	73.5	1	0.366
	90	23	1.5	50.9	24.0	1.85	13.2	7 700	6 900	5 100	9 200	6308 ZZ	6308 2RU	6308 2RD	6308 2RS	48	51.5	82	1.5	0.633

[Remark] Standard cage types used for the above bearings are described earlier in this section.

Single-row deep groove ball bearings  
shielded type  
sealed type

d 45 ~ (70) mm



Boundary dimensions (mm)				Basic load ratings (kN)		Fatigue load limit (kN) Cu	Factor fo	Limiting speeds (min <sup>-1</sup> )			Oil lub. (Z)	Bearing No.				Mounting dimensions (mm)				(Refer.) Mass Open type (kg)
d	D	B	r min.	Cr	Cor			Grease lub.		Oil lub.		Shielded	Non-contact sealed	Extremely light contact sealed	Contact sealed	da min.	da max.	Da max.	ra max.	
45	58	7	0.3	7.75	5.40	0.230	16.3	11 000	9 900	5 900	13 000	6809 ZZ	6809 2RU	6809 2RD	6809 2RS	47	47	56	0.3	0.040
	68	12	0.6	17.7	10.9	0.600	15.9	9 700	8 700	5 500	11 000	6909 ZZ	6909 2RU	6909 2RD	6909 2RS	49	50	64	0.6	0.132
	75	16	1	26.2	15.1	0.900	15.3	9 200	8 300	5 300	11 000	6009 ZZ	6009 2RU	6009 2RD	6009 2RS	50	51.5	70	1	0.245
	85	19	1.1	40.9	20.3	1.40	14.0	7 700	6 900	5 100	9 200	6209 ZZ	6209 2RU	6209 2RD	6209 2RS	51.5	53.5	78.5	1	0.407
	100	25	1.5	61.1	29.5	2.25	13.3	6 800	6 100	4 500	8 100	6309 ZZ	6309 2RU	6309 2RD	6309 2RS	53	59.5	92	1.5	0.833
50	65	7	0.3	8.20	6.10	0.260	16.1	9 600	8 600	5 200	11 000	6810 ZZ	6810 2RU	6810 2RD	6810 2RS	52	53	63	0.3	0.052
	72	12	0.6	18.2	11.7	0.640	16.1	9 000	—	5 000	11 000	6910 ZZ	6910 2RU	—	—	54	55.5	68	0.6	0.133
	80	16	1	27.3	16.6	0.960	15.6	8 400	7 600	4 800	9 900	6010 ZZ	6010 2RU	6010 2RD	6010 2RS	55	57	75	1	0.261
	90	20	1.1	43.9	23.3	1.55	14.4	7 100	6 400	4 600	8 500	6210 ZZ	6210 2RU	6210 2RD	6210 2RS	56.5	59	83.5	1	0.463
	110	27	2	77.5	38.3	2.90	13.2	6 100	5 500	4 100	7 300	6310 ZZ	6310 2RU	6310 2RD	6310 2RS	59	66.5	101	2	1.07
55	72	9	0.3	11.0	8.10	0.420	16.2	8 700	7 800	—	10 000	6811 ZZ	6811 2RU	6811 2RD	—	57	58.5	70	0.3	0.083
	80	13	1	20.8	14.1	0.760	16.2	8 100	7 300	4 500	9 600	6911 ZZ	6911 2RU	6911 2RD	6911 2RS	60	60.5	75	1	0.185
	90	18	1.1	35.3	21.2	1.25	15.3	7 600	6 800	4 300	8 900	6011 ZZ	6011 2RU	6011 2RD	6011 2RS	61.5	62	83.5	1	0.385
	100	21	1.5	54.2	29.4	1.95	14.4	6 300	5 700	4 100	7 600	6211 ZZ	6211 2RU	6211 2RD	6211 2RS	63	66	92	1.5	0.607
	120	29	2	89.5	45.0	3.45	13.2	5 600	—	3 700	6 700	6311 ZZ	6311 2RU	—	6311 2RS	64	74.5	111	2	1.37
60	78	10	0.3	14.3	10.6	0.550	16.3	8 000	7 200	—	9 400	6812 ZZ	6812 2RU	6812 2RD	—	62	63	76	0.3	0.104
	85	13	1	25.2	17.3	0.940	16.2	7 500	—	—	8 900	6912 ZZ	6912 2RU	—	—	65	66	80	1	0.192
	95	18	1.1	36.8	23.2	1.35	15.6	7 100	—	4 000	8 400	6012 ZZ	6012 2RU	—	6012 2RS	66.5	68.5	88.5	1	0.415
	110	22	1.5	65.6	36.2	2.40	14.4	5 700	5 100	3 700	6 900	6212 ZZ	6212 2RU	6212 2RD	6212 2RS	68	72.5	102	1.5	0.783
	130	31	2.1	102	52.2	3.95	13.2	5 200	—	3 500	6 200	6312 ZZ	6312 2RU	—	6312 2RS	71	80	119	2	1.70
65	85	10	0.6	14.9	11.5	0.590	16.2	7 300	6 600	—	8 600	6813 ZZ	6813 2RU	6813 2RD	—	69	69	81	0.6	0.126
	90	13	1	21.7	16.1	0.830	16.6	7 100	6 400	3 900	8 400	6913 ZZ	6913 2RU	6913 2RD	6913 2RS	70	71	85	1	0.211
	100	18	1.1	38.1	25.2	1.40	15.8	6 600	—	3 700	7 800	6013 ZZ	6013 2RU	—	6013 2RS	71.5	74.5	93.5	1	0.435
	120	23	1.5	71.5	40.1	2.65	14.4	5 400	—	3 500	6 400	6213 ZZ	6213 2RU	—	6213 2RS	73	79	112	1.5	0.990
	140	33	2.1	116	59.9	4.50	13.2	4 800	—	3 200	5 800	6313 ZZ	6313 2RU	—	6313 2RS	76	86	129	2	2.08
70	90	10	0.6	15.1	11.9	0.620	16.1	6 800	6 100	—	8 100	6814 ZZ	6814 2RU	6814 2RD	—	74	74	86	0.6	0.134
	100	16	1	29.7	21.2	1.10	16.3	6 400	5 800	3 600	7 600	6914 ZZ	6914 2RU	6914 2RD	6914 2RS	75	76.5	95	1	0.342

[Remark] Standard cage types used for the above bearings are described earlier in this section.

Single-row deep groove ball bearings  
shielded type  
sealed type

d (70) ~ 95 mm



Boundary dimensions (mm)				Basic load ratings (kN)		Fatigue load limit (kN) $C_u$	Factor $f_0$	Limiting speeds ( $\text{min}^{-1}$ )				Bearing No.				Mounting dimensions (mm)				(Refer.) Mass Open type (kg)
d	D	B	r min.	$C_r$	$C_{0r}$			Grease lub.		Oil lub.		Shielded	Non-contact sealed	Extremely light contact sealed	Contact sealed	$d_a$ min.	$d_a$ max.	$D_a$ max.	$r_a$ max.	
								[ Z, ZZ ] [ RU, 2RU ]	(RD, 2RD)	(RS, 2RS)	(Z)									
<b>70</b>	110	20	1.1	47.6	30.9	1.80	15.6	6 100	—	3 500	7 200	<b>6014 ZZ</b>	<b>6014 2RU</b>	—	<b>6014 2RS</b>	76.5	79.5	103.5	1	0.602
	125	24	1.5	77.8	44.1	2.90	14.5	5 100	—	3 300	6 100	<b>6214 ZZ</b>	<b>6214 2RU</b>	—	<b>6214 2RS</b>	78	84	117	1.5	1.07
	150	35	2.1	130	68.2	4.95	13.2	4 500	—	3 000	5 400	<b>6314 ZZ</b>	<b>6314 2RU</b>	—	<b>6314 2RS</b>	81	92	139	2	2.52
<b>75</b>	95	10	0.6	15.7	12.9	0.660	16.0	6 400	5 800	—	7 600	<b>6815 ZZ</b>	<b>6815 2RU</b>	<b>6815 2RD</b>	—	79	79	91	0.6	0.142
	105	16	1	30.5	22.6	1.20	16.5	6 100	—	—	7 200	<b>6915 ZZ</b>	<b>6915 2RU</b>	—	—	80	82.5	100	1	0.363
	115	20	1.1	49.4	33.5	1.90	15.8	5 700	—	3 300	6 800	<b>6015 ZZ</b>	<b>6015 2RU</b>	—	<b>6015 2RS</b>	81.5	84.5	108.5	1	0.638
	130	25	1.5	84.3	48.3	3.10	14.5	4 800	—	3 100	5 800	<b>6215 ZZ</b>	<b>6215 2RU</b>	—	<b>6215 2RS</b>	83	88.5	122	1.5	1.18
	160	37	2.1	142	77.2	5.40	13.2	4 200	—	2 800	5 000	<b>6315 ZZ</b>	<b>6315 2RU</b>	—	<b>6315 2RS</b>	86	97.5	149	2	3.02
<b>80</b>	100	10	0.6	15.9	13.3	0.690	16.0	6 100	5 500	—	7 200	<b>6816 ZZ</b>	<b>6816 2RU</b>	<b>6816 2RD</b>	—	84	84	96	0.6	0.150
	110	16	1	31.2	24.0	1.25	16.6	5 700	5 100	3 200	6 800	<b>6916 ZZ</b>	<b>6916 2RU</b>	<b>6916 2RD</b>	<b>6916 2RS</b>	85	86.5	105	1	0.382
	125	22	1.1	59.5	39.8	2.25	15.6	5 300	—	3 100	6 300	<b>6016 ZZ</b>	<b>6016 2RU</b>	—	<b>6016 2RS</b>	86.5	90	118.5	1	0.850
	140	26	2	90.9	53.0	3.25	14.6	4 500	—	2 900	5 400	<b>6216 ZZ</b>	<b>6216 2RU</b>	—	<b>6216 2RS</b>	89	93	131	2	1.40
	170	39	2.1	154	86.7	5.85	13.3	3 900	—	2 700	4 700	<b>6316 ZZ</b>	<b>6316 2RU</b>	—	<b>6316 2RS</b>	91	105	159	2	3.59
<b>85</b>	110	13	1	23.4	19.0	0.980	16.2	5 600	5 000	—	6 600	<b>6817 ZZ</b>	<b>6817 2RU</b>	<b>6817 2RD</b>	—	90	90.5	105	1	0.266
	120	18	1.1	39.9	29.6	1.55	16.4	5 300	4 800	3 000	6 300	<b>6917 ZZ</b>	<b>6917 2RU</b>	<b>6917 2RD</b>	<b>6917 2RS</b>	91.5	92.5	113.5	1	0.535
	130	22	1.1	61.8	43.1	2.35	15.8	5 000	—	2 900	5 900	<b>6017 ZZ</b>	<b>6017 2RU</b>	—	<b>6017 2RS</b>	91.5	96.5	123.5	1	0.890
	150	28	2	105	61.9	3.70	14.5	4 200	—	2 700	5 000	<b>6217 ZZ</b>	<b>6217 2RU</b>	—	<b>6217 2RS</b>	94	102	141	2	1.79
	180	41	3	166	96.8	6.35	13.3	3 700	—	2 500	4 400	<b>6317 ZZ</b>	<b>6317 2RU</b>	—	<b>6317 2RS</b>	98	111	167	2.5	4.23
<b>90</b>	115	13	1	23.8	19.7	1.00	16.1	5 300	4 800	—	6 300	<b>6818 ZZ</b>	<b>6818 2RU</b>	<b>6818 2RD</b>	—	95	95.5	110	1	0.279
	125	18	1.1	41.0	31.6	1.60	16.5	5 100	4 600	2 800	6 000	<b>6918 ZZ</b>	<b>6918 2RU</b>	<b>6918 2RD</b>	<b>6918 2RS</b>	96.5	97.5	118.5	1	0.565
	140	24	1.5	72.8	49.7	2.65	15.6	4 700	—	2 700	5 600	<b>6018 ZZ</b>	<b>6018 2RU</b>	—	<b>6018 2RS</b>	98	100.5	132	1.5	1.16
	160	30	2	120	71.5	4.20	14.5	3 900	—	2 600	4 700	<b>6218 ZZ</b>	<b>6218 2RU</b>	—	<b>6218 2RS</b>	99	108.5	151	2	2.15
	190	43	3	178	107	8.80	13.3	3 500	—	2 400	4 200	<b>6318 ZZ</b>	<b>6318 2RU</b>	—	<b>6318 2RS</b>	103	117	177	2.5	4.91
<b>95</b>	130	18	1.1	42.1	33.5	1.65	16.6	4 800	4 300	2 700	5 700	<b>6919 ZZ</b>	<b>6919 2RU</b>	<b>6919 2RD</b>	<b>6919 2RS</b>	101.5	102	123.5	1	0.705
	145	24	1.5	75.5	53.9	2.75	15.8	4 400	—	2 500	5 200	<b>6019 ZZ</b>	<b>6019 2RU</b>	—	<b>6019 2RS</b>	103	107.5	137	1.5	1.21
	170	32	2.1	136	81.9	4.65	14.4	3 700	—	2 400	4 400	<b>6219 ZZ</b>	<b>6219 2RU</b>	—	<b>6219 2RS</b>	106	113	159	2	2.62
	200	45	3	191	119	9.45	13.3	3 300	—	2 200	4 000	<b>6319 ZZ</b>	<b>6319 2RU</b>	—	<b>6319 2RS</b>	108	122	187	2.5	5.67

[Remark] Standard cage types used for the above bearings are described earlier in this section.

Single-row deep groove ball bearings  
shielded type  
sealed type

d 100 ~ (140) mm



Boundary dimensions (mm)				Basic load ratings (kN)		Fatigue load limit (kN) $C_u$	Factor $f_0$	Limiting speeds ( $\text{min}^{-1}$ )				Bearing No.				Mounting dimensions (mm)				(Refer.) Mass Open type (kg)
$d$	$D$	$B$	$r_{\text{min}}$	$C_r$	$C_{0r}$			Grease lub.		Oil lub.		Shielded	Non-contact sealed	Extremely light contact sealed	Contact sealed	$d_a$ min.	$d_a$ max.	$D_a$ max.	$r_a$ max.	
								[ Z, ZZ ] [ RU, 2RU ]	(RD, 2RD)	(RS, 2RS)	(Z)									
100	125	13	1	24.5	21.2	1.05	16.0	4 800	4 300	—	5 700	6820 ZZ	6820 2RU	6820 2RD	—	105	105.5	120	1	0.309
	140	20	1.1	51.5	39.6	1.90	16.2	4 500	—	—	5 300	6920-1 ZZ	6920-1 2RU	—	—	106.5	110.5	133.5	1	0.960
	150	24	1.5	75.2	54.2	2.70	15.9	4 300	—	2 500	5 100	6020 ZZ	6020 2RU	—	6020 2RS	108	112	142	1.5	1.25
	180	34	2.1	153	93.1	5.15	14.4	3 500	—	2 300	4 200	6220 ZZ	6220 2RU	—	6220 2RS	111	122	169	2	3.14
	215	47	3	216	141	10.9	13.2	3 000	—	2 100	3 600	6320 ZZ	6320 2RU	—	6320 2RS	113	131	202	2.5	7.00
105	145	20	1.1	53.0	42.1	1.95	16.4	4 300	—	2 400	5 100	6921-1 ZZ	6921-1 2RU	—	6921-1 2RS	111.5	115	138.5	1	1.00
	160	26	2	90.4	65.8	3.20	15.8	4 000	—	2 300	4 700	6021 ZZ	6021 2RU	—	6021 2RS	114	119	151	2	1.59
	190	36	2.1	166	105	5.70	14.4	3 300	—	2 200	3 900	6221 ZZ	6221 2RU	—	6221 2RS	116	127	179	2	3.70
	225	49	3	230	153	11.7	13.2	2 900	—	2 000	3 500	6321 ZZ	6321 2RU	—	6321 2RS	118	136	212	2.5	8.05
110	140	16	1	35.1	30.7	1.40	16.1	4 300	3 900	—	5 100	6822 ZZ	6822 2RU	6822 2RD	—	115	116.5	135	1	0.606
	150	20	1.1	59.9	47.8	2.20	16.4	4 100	—	—	4 900	6922 ZZ	6922 2RU	—	—	116.5	119.5	143.5	1	1.04
	170	28	2	103	73.0	3.55	15.6	3 800	—	2 200	4 500	6022 ZZ	6022 2RU	—	6022 2RS	119	123	161	2	1.96
	200	38	2.1	180	117	6.20	14.4	3 100	—	2 000	3 700	6222 ZZ	6222 2RU	—	6222 2RS	121	136.5	189	2	4.36
	240	50	3	257	180	13.3	13.2	2 700	—	1 900	3 200	6322 ZZ	6322 2RU	—	6322 2RS	123	146.5	227	2.5	9.54
120	150	16	1	36.2	33.0	1.45	16.0	4 000	—	—	4 700	6824 ZZ	6824 2RU	—	—	125	128.5	145	1	0.655
	165	22	1.1	71.6	56.9	2.50	16.4	3 800	—	—	4 400	6924 ZZ	6924 2RU	—	—	126.5	131.5	158.5	1	1.41
	180	28	2	106	79.3	3.60	15.9	3 600	—	2 100	4 200	6024 ZZ	6024 2RU	—	6024 2RS	129	136	171	2	2.07
	215	40	2.1	194	131	6.65	14.4	2 900	—	1 900	3 400	6224 ZZ	6224 2RU	—	6224 2RS	131	144	204	2	5.15
	260	55	3	258	185	12.6	13.5	2 500	—	—	3 000	6324 ZZ	—	—	—	133	158	247	2.5	12.5
130	165	18	1.1	46.1	41.2	1.75	16.1	3 600	—	—	4 300	6826 ZZ	6826 2RU	—	—	136.5	139.5	158.5	1	0.939
	180	24	1.5	81.5	67.4	2.85	16.3	3 400	—	—	4 100	6926-1 ZZ	6926-1 2RU	—	—	138	144	172	1.5	1.86
	200	33	2	133	101	4.45	15.8	3 200	—	1 900	3 800	6026 ZZ	6026 2RU	—	6026 2RS	139	146.5	191	2	3.16
	230	40	3	209	146	9.15	14.5	2 700	—	1 800	3 200	6226 ZZ	6226 2RU	—	6226 2RS	143	157	217	2.5	5.82
	280	58	4	287	214	14.1	13.6	2 300	—	—	2 700	6326 ZZ	—	—	—	146	171	264	3	15.1
140	175	18	1.1	47.8	44.4	1.85	16.0	3 400	3 100	—	4 000	6828 ZZ	—	6828 2RD	—	146.5	148	168.5	1	1.00
	190	24	1.5	83.3	71.6	2.90	16.5	3 200	—	—	3 800	6928-1 ZZ	6928-1 2RU	—	—	148	153	182	1.5	1.98
	210	33	2	137	109	4.55	15.9	3 000	—	1 800	3 600	6028 ZZ	6028 2RU	—	6028 2RS	149	158.5	201	2	3.55

[Remark] Standard cage types used for the above bearings are described earlier in this section.

Single-row deep groove ball bearings  
shielded type  
sealed type

d (140) ~ 220 mm



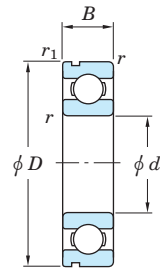
Boundary dimensions (mm)				Basic load ratings (kN)		Fatigue load limit (kN) $C_u$	Factor $f_0$	Limiting speeds ( $\text{min}^{-1}$ )			Oil lub. (Z)	Bearing No.				Mounting dimensions (mm)				(Refer.) Mass Open type (kg)
d	D	B	r min.	$C_r$	$C_{0r}$			Grease lub.		Oil lub.		Shielded	Non-contact sealed	Extremely light contact sealed	Contact sealed	$d_a$ min.	$d_a$ max.	$D_a$ max.	$r_a$ max.	
140	250	42	3	208	150	8.65	14.8	2 400	—	1 600	2 900	6228 ZZ	6228 2RU	—	6228 2RS	153	169	237	2.5	7.45
	300	62	4	316	246	15.6	13.6	2 100	—	—	2 500	6328 ZZ	—	—	—	156	184	284	3	19.4
150	210	28	2	117	94.3	3.75	16.2	2 900	—	1 700	3 400	6930 ZZ	6930 2RU	—	6930 2RS	159	165.5	201	2	3.05
	225	35	2.1	157	126	5.10	16.0	2 800	—	1 600	3 300	6030 ZZ	6030 2RU	—	6030 2RS	161	168.5	214	2	4.22
	270	45	3	220	168	9.05	15.1	2 200	—	—	2 700	6230 ZZ	—	—	—	163	183.5	257	2.5	9.41
160	200	20	1.1	60.5	56.9	2.20	16.1	2 900	2 600	—	3 400	6832 ZZ	—	6832 2RD	—	166.5	168.5	193.5	1	1.45
	240	38	2.1	171	135	5.30	15.9	2 600	—	1 500	3 000	6032 ZZ	6032 2RU	—	6032 2RS	171	178.5	229	2	5.22
	290	48	3	231	186	9.45	15.4	2 100	—	—	2 500	6232 ZZ	—	—	—	173	198	277	2.5	14.3
170	215	22	1.1	74.8	70.5	2.60	16.1	2 700	—	—	3 200	6834 ZZ	—	—	—	176.5	182.5	208.5	1	1.90
	260	42	2.1	201	161	6.20	15.8	2 400	—	—	2 800	6034 ZZ	6034 2RU	—	—	181	194	249	2	6.80
	310	52	4	265	223	11.1	15.3	1 900	—	—	2 300	6234 ZZ	—	—	—	186	210.5	294	3	17.5
180	225	22	1.1	75.8	73.1	2.65	16.1	2 600	2 300	—	3 000	6836 ZZ	—	6836 2RD	—	186.5	189.5	218.5	1	2.00
	280	46	2.1	227	194	7.15	15.8	2 200	—	—	2 600	6036 ZZ	6036 2RU	—	—	191	209.5	269	2	10.3
	320	52	4	264	226	10.8	15.1	1 800	—	—	2 200	6236-1 ZZ	—	—	—	196	220.5	304	3	18.3
190	240	24	1.5	91.4	88.1	3.10	16.1	2 400	—	—	2 800	6838 ZZ	—	—	—	198	202	232	1.5	2.60
	290	46	2.1	235	201	7.35	15.8	2 100	—	—	2 500	6038 ZZ	—	—	—	201	215	279	2	10.8
200	310	51	2.1	272	243	11.3	15.6	1 900	—	—	2 300	6040 ZZ	—	—	—	211	228	299	2	14.0
	360	58	4	314	293	13.1	15.2	1 600	—	—	1 900	6240-1 ZZ	—	—	—	216	250	344	3	28.2
220	340	56	3	294	271	12.0	15.6	1 700	—	—	2 000	6044 ZZ	—	—	—	233	251	327	2.5	18.3

[Remark] Standard cage types used for the above bearings are described earlier in this section.

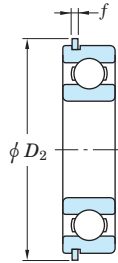


Single-row deep groove ball bearings  
snap ring groove type  
locating snap ring type

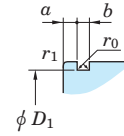
d 10 ~ 32 mm



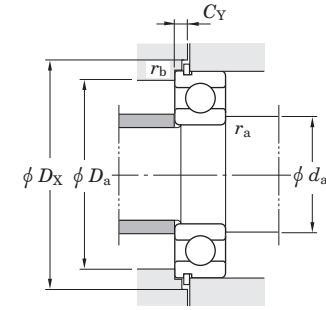
N  
With snap ring groove



NR  
With locating snap ring



Snap ring groove details



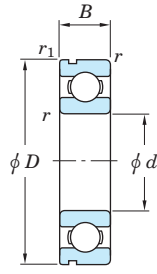
With locating snap ring and one shield

Boundary dimensions (mm)					Basic load ratings (kN)		Fatigue load limit	Factor	Limiting speeds (min <sup>-1</sup> )		Bearing No.		Dimensions of snap ring groove (mm)				Dimensions of locating snap ring (mm)		Mounting dimensions (mm)						(Refer.) Mass (kg)	(Refer.) Bearing No.
d	D	B	r min.	r1 min.	C <sub>r</sub>	C <sub>0r</sub>	C <sub>u</sub>	f <sub>0</sub>	Grease lub.	Oil lub.	With snap ring groove	With locating snap ring	D <sub>1</sub> max.	a max.	b ±0.15	r <sub>0</sub> max.	D <sub>2</sub> max.	f ±0.05	d <sub>a</sub> min.	D <sub>a</sub> max.	D <sub>X</sub> min.	C <sub>Y</sub> max.	r <sub>a</sub> max.	r <sub>b</sub> max.		
10	30	9	0.6	0.3	6.40	2.40	0.120	13.2	24 000	29 000	6200N	6200NR	28.17	2.06	1.5	0.4	34.7	1.07	14	26	35.5	2.92	0.6	0.3	0.032	6200N
	35	11	0.6	0.5	10.1	3.45	0.270	11.2	22 000	27 000	6300N	6300NR	33.17	2.06	1.5	0.4	39.7	1.07	14	31	40.5	2.92	0.6	0.5	0.053	6300N
12	32	10	0.6	0.3	8.50	3.05	0.240	12.3	22 000	27 000	6201N	6201NR	30.15	2.06	1.5	0.4	36.7	1.07	16	28	37.5	2.92	0.6	0.3	0.037	6201N
	37	12	1	0.5	12.1	4.20	0.420	11.1	20 000	25 000	6301N	6301NR	34.77	2.06	1.5	0.4	41.3	1.07	17	32	42	2.92	1	0.5	0.060	6301N
15	35	11	0.6	0.5	9.55	3.75	0.290	13.2	20 000	24 000	6202N	6202NR	33.17	2.06	1.5	0.4	39.7	1.07	19	31	40.5	2.92	0.6	0.5	0.045	6202N
	42	13	1	0.5	14.3	5.45	0.460	12.3	17 000	20 000	6302N	6302NR	39.75	2.06	1.5	0.4	46.3	1.07	20	37	47	2.92	1	0.5	0.082	6302N
17	40	12	0.6	0.5	12.0	4.80	0.370	13.2	17 000	21 000	6203N	6203NR	38.1	2.06	1.5	0.4	44.6	1.07	21	36	45.5	2.92	0.6	0.5	0.065	6203N
	47	14	1	0.5	17.0	6.65	0.550	12.4	15 000	18 000	6303N	6303NR	44.6	2.46	1.5	0.4	52.7	1.07	22	42	53.5	3.33	1	0.5	0.115	6303N
20	42	12	0.6	0.5	11.7	5.05	0.350	13.9	17 000	21 000	6004N	6004NR	39.75	2.06	1.5	0.4	46.3	1.07	24	38	47	2.92	0.6	0.5	0.069	6004N
	47	14	1	0.5	16.0	6.65	0.510	13.2	15 000	17 000	6204N	6204NR	44.6	2.46	1.5	0.4	52.7	1.07	25	42	53.5	3.33	1	0.5	0.106	6204N
	52	15	1.1	0.5	19.9	7.85	0.660	12.3	14 000	17 000	6304N	6304NR	49.73	2.46	1.5	0.4	57.9	1.07	26.5	45.5	58.5	3.33	1	0.5	0.144	6304N
22	44	12	0.6	0.5	11.7	5.15	0.350	14.1	17 000	20 000	60/22N	60/22NR	41.75	2.06	1.5	0.4	48.3	1.07	26	40	49	2.92	0.6	0.5	0.073	60/22N
	50	14	1	0.5	16.0	6.65	0.510	13.2	15 000	17 000	62/22N	62/22NR	47.6	2.46	1.5	0.4	55.7	1.07	27	45	56.5	3.33	1	0.5	0.118	62/22N
	56	16	1.1	0.5	23.1	9.40	0.770	12.6	13 000	15 000	63/22N	63/22NR	53.6	2.46	1.5	0.4	61.7	1.07	28.5	49.5	62.5	3.33	1	0.5	0.201	63/22N
25	47	12	0.6	0.5	12.6	5.85	0.380	14.5	15 000	18 000	6005N	6005NR	44.6	2.06	1.5	0.4	52.7	1.07	29	43	53.5	2.92	0.6	0.5	0.080	6005N
	52	15	1	0.5	17.5	7.85	0.550	13.9	13 000	15 000	6205N	6205NR	49.73	2.46	1.5	0.4	57.9	1.07	30	47	58.5	3.33	1	0.5	0.128	6205N
	62	17	1.1	0.5	25.7	11.3	0.860	13.2	11 000	13 000	6305N	6305NR	59.61	3.28	2.05	0.6	67.7	1.65	31.5	55.5	68.5	4.67	1	0.5	0.232	6305N
28	52	12	0.6	0.5	15.6	7.40	0.480	14.5	14 000	16 000	60/28N	60/28NR	49.73	2.06	1.5	0.4	57.9	1.07	32	48	58.5	2.92	0.6	0.5	0.097	60/28N
	58	16	1	0.5	22.4	9.75	0.720	13.4	12 000	14 000	62/28N	62/28NR	55.6	2.46	1.5	0.4	63.7	1.07	33	53	64.5	3.33	1	0.5	0.173	62/28N
	68	18	1.1	0.5	29.4	13.1	0.990	13.3	10 000	12 000	63/28N	63/28NR	64.82	3.28	2.05	0.6	74.6	1.65	34.5	61.5	76	4.67	1	0.5	0.328	63/28N
30	55	13	1	0.5	16.5	8.25	0.530	14.7	13 000	15 000	6006N	6006NR	52.6	2.08	1.5	0.4	60.7	1.07	35	50	61.5	2.9	1	0.5	0.116	6006N
	62	16	1	0.5	24.3	11.3	0.800	13.9	11 000	13 000	6206N	6206NR	59.61	3.28	2.05	0.6	67.7	1.65	35	57	68.5	4.67	1	0.5	0.199	6206N
	72	19	1.1	0.5	33.3	15.0	1.15	13.3	9 600	12 000	6306N	6306NR	68.81	3.28	2.05	0.6	78.6	1.65	36.5	65.5	80	4.67	1	0.5	0.346	6306N
32	58	13	1	0.5	18.8	9.15	0.600	14.5	12 000	14 000	60/32N	60/32NR	55.6	2.08	1.5	0.4	63.7	1.07	37	53	64.5	2.9	1	0.5	0.127	60/32N
	65	17	1	0.5	29.4	13.1	0.990	13.3	10 000	12 000	62/32N	62/32NR	62.6	3.28	2.05	0.6	70.7	1.65	37	60	71.5	4.67	1	0.5	0.228	62/32N
	75	20	1.1	0.5	37.6	16.2	1.30	12.7	9 300	11 000	63/32N	63/32NR	71.83	3.28	2.05	0.6	81.6	1.65	38.5	68.5	83	4.67	1	0.5	0.437	63/32N

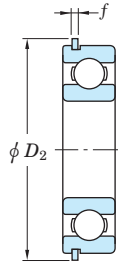
[Remark] Standard cage types used for the above bearings are described earlier in this section.

Single-row deep groove ball bearings  
snap ring groove type  
locating snap ring type

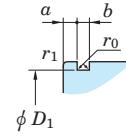
d 35 ~ 75 mm



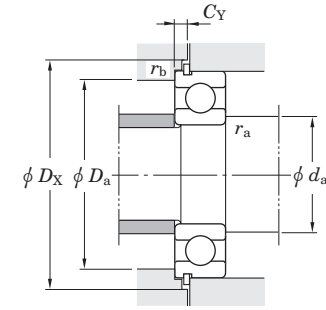
N  
With snap ring groove



NR  
With locating snap ring



Snap ring groove details



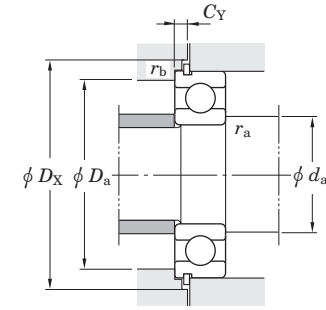
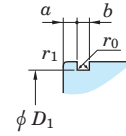
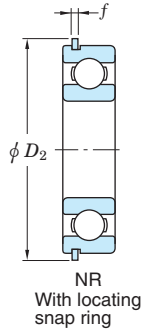
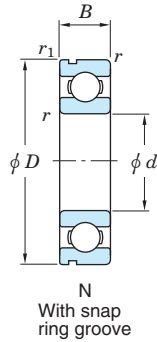
With locating snap ring and one shield

Boundary dimensions (mm)					Basic load ratings (kN)		Fatigue load limit	Factor	Limiting speeds (min <sup>-1</sup> )		Bearing No.		Dimensions of snap ring groove (mm)				Dimensions of locating snap ring (mm)		Mounting dimensions (mm)						(Refer.) Mass (kg)	(Refer.) Bearing No.
d	D	B	r min.	r1 min.	Cr	C0r	(kN) Cu	f0	Grease lub.	Oil lub.	With snap ring groove	With locating snap ring	D1 max.	a max.	b ±0.15	r0 max.	D2 max.	f ±0.05	da min.	Da max.	DX min.	CY max.	ra max.	rb max.		
35	62	14	1	0.5	19.9	10.3	0.640	14.9	11 000	13 000	6007N	6007NR	59.61	2.08	2.05	0.6	67.7	1.65	40	58	68.5	3.48	1	0.5	0.155	6007N
	72	17	1.1	0.5	32.1	15.4	1.10	13.9	9 200	11 000	6207N	6207NR	68.81	3.28	2.05	0.6	78.6	1.65	41.5	65.5	80	4.67	1	0.5	0.288	6207N
	80	21	1.5	0.5	41.7	19.3	1.45	13.2	8 500	10 000	6307N	6307NR	76.81	3.28	2.05	0.6	86.6	1.65	43	72	88	4.67	1.5	0.5	0.457	6307N
40	68	15	1	0.5	20.9	11.5	0.690	15.2	10 000	12 000	6008N	6008NR	64.82	2.49	2.05	0.6	74.6	1.65	45	63	76	3.89	1	0.5	0.192	6008N
	80	18	1.1	0.5	36.4	17.8	1.25	14.0	8 300	10 000	6208N	6208NR	76.81	3.28	2.05	0.6	86.6	1.65	46.5	73.5	88	4.67	1	0.5	0.366	6208N
	90	23	1.5	0.5	50.9	24.0	1.85	13.2	7 700	9 200	6308N	6308NR	86.79	3.28	2.85	0.6	96.5	2.41	48	82	98	5.43	1.5	0.5	0.633	6308N
45	75	16	1	0.5	26.2	15.1	0.900	15.3	9 200	11 000	6009N	6009NR	71.83	2.49	2.05	0.6	81.6	1.65	50	70	83	3.89	1	0.5	0.245	6009N
	85	19	1.1	0.5	40.9	20.3	1.40	14.0	7 700	9 200	6209N	6209NR	81.81	3.28	2.05	0.6	91.6	1.65	51.5	78.5	93	4.67	1	0.5	0.407	6209N
	100	25	1.5	0.5	61.1	29.5	2.25	13.3	6 800	8 100	6309N	6309NR	96.8	3.28	2.85	0.6	106.5	2.41	53	92	108	5.43	1.5	0.5	0.833	6309N
50	80	16	1	0.5	27.3	16.6	0.960	15.6	8 400	9 900	6010N	6010NR	76.81	2.49	2.05	0.6	86.6	1.65	55	75	88	3.89	1	0.5	0.261	6010N
	90	20	1.1	0.5	43.9	23.3	1.55	14.4	7 100	8 500	6210N	6210NR	86.79	3.28	2.85	0.6	96.5	2.41	56.5	83.5	98	5.43	1	0.5	0.463	6210N
	110	27	2	0.5	77.5	38.3	2.90	13.2	6 100	7 300	6310N	6310NR	106.81	3.28	2.85	0.6	116.6	2.41	59	101	118	5.43	2	0.5	1.07	6310N
55	90	18	1.1	0.5	35.3	21.2	1.25	15.3	7 600	8 900	6011N	6011NR	86.79	2.87	2.85	0.6	96.5	2.41	61.5	83.5	98	5.03	1	0.5	0.385	6011N
	100	21	1.5	0.5	54.2	29.4	1.95	14.4	6 300	7 600	6211N	6211NR	96.8	3.28	2.85	0.6	106.5	2.41	63	92	108	5.43	1.5	0.5	0.607	6211N
	120	29	2	0.5	89.5	45.0	3.45	13.2	5 600	6 700	6311N	6311NR	115.21	4.06	3.25	0.6	129.7	2.77	64	111	131.5	6.58	2	0.5	1.37	6311N
60	95	18	1.1	0.5	36.8	23.2	1.35	15.6	7 100	8 400	6012N	6012NR	91.82	2.87	2.85	0.6	101.6	2.41	66.5	88.5	103	5.03	1	0.5	0.415	6012N
	110	22	1.5	0.5	65.6	36.2	2.40	14.4	5 700	6 900	6212N	6212NR	106.81	3.28	2.85	0.6	116.6	2.41	68	102	118	5.43	1.5	0.5	0.783	6212N
	130	31	2.1	0.5	102	52.2	3.95	13.2	5 200	6 200	6312N	6312NR	125.22	4.06	3.25	0.6	139.7	2.77	71	119	141.5	6.58	2	0.5	1.70	6312N
65	100	18	1.1	0.5	38.1	25.2	1.40	15.8	6 600	7 800	6013N	6013NR	96.8	2.87	2.85	0.6	106.5	2.41	71.5	93.5	108	5.03	1	0.5	0.435	6013N
	120	23	1.5	0.5	71.5	40.1	2.65	14.4	5 400	6 400	6213N	6213NR	115.21	4.06	3.25	0.6	129.7	2.77	73	112	131.5	6.58	1.5	0.5	0.990	6213N
	140	33	2.1	0.5	116	59.9	4.50	13.2	4 800	5 800	6313N	6313NR	135.23	4.9	3.25	0.6	149.7	2.77	76	129	152	7.37	2	0.5	2.08	6313N
70	110	20	1.1	0.5	47.6	30.9	1.80	15.6	6 100	7 200	6014N	6014NR	106.81	2.87	2.85	0.6	116.6	2.41	76.5	103.5	118	5.03	1	0.5	0.602	6014N
	125	24	1.5	0.5	77.8	44.1	2.90	14.5	5 100	6 100	6214N	6214NR	120.22	4.06	3.25	0.6	134.7	2.77	78	117	136.5	6.58	1.5	0.5	1.07	6214N
	150	35	2.1	0.5	130	68.2	4.95	13.2	4 500	5 400	6314N	6314NR	145.24	4.9	3.25	0.6	159.7	2.77	81	139	162	7.37	2	0.5	2.52	6314N
75	115	20	1.1	0.5	49.4	33.5	1.90	15.8	5 700	6 800	6015N	6015NR	111.81	2.87	2.85	0.6	121.6	2.41	81.5	108.5	123	5.03	1	0.5	0.638	6015N
	130	25	1.5	0.5	84.3	48.3	3.10	14.5	4 800	5 800	6215N	6215NR	125.22	4.06	3.25	0.6	139.7	2.77	83	122	141.5	6.58	1.5	0.5	1.18	6215N
	160	37	2.1	0.5	142	77.2	5.40	13.2	4 200	5 000	6315N	6315NR	155.22	4.9	3.25	0.6	169.7	2.77	86	149	172	7.37	2	0.5	3.02	6315N

[Remark] Standard cage types used for the above bearings are described earlier in this section.

Single-row deep groove ball bearings  
snap ring groove type  
locating snap ring type

d 80 ~ 130 mm

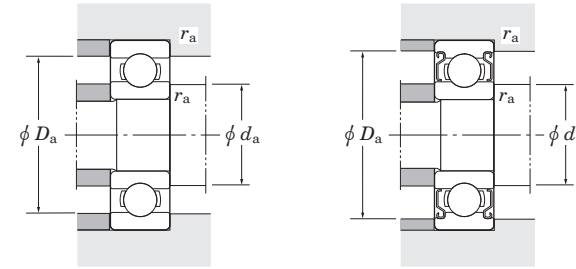
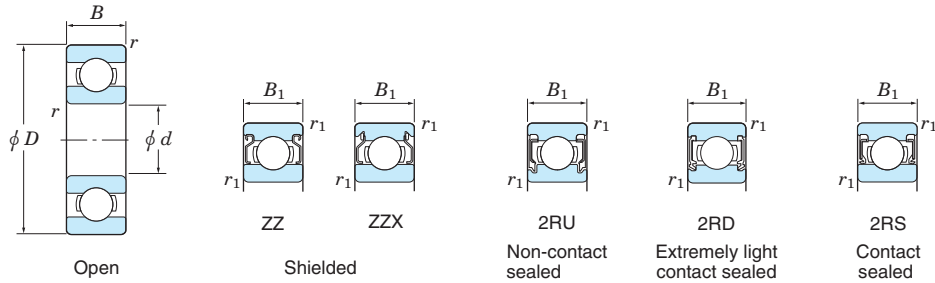


Boundary dimensions (mm)					Basic load ratings (kN)		Fatigue load limit	Factor	Limiting speeds (min <sup>-1</sup> )		Bearing No.		Dimensions of snap ring groove (mm)				Dimensions of locating snap ring (mm)		Mounting dimensions (mm)						(Refer.) Mass (kg)	(Refer.) Bearing No.
d	D	B	r min.	r1 min.	Cr	C0r	(kN) Cu	f0	Grease lub.	Oil lub.	With snap ring groove	With locating snap ring	D1 max.	a max.	b ±0.15	r0 max.	D2 max.	f ±0.05	da min.	Da max.	DX min.	CY max.	ra max.	rb max.		
80	125	22	1.1	0.5	59.5	39.8	2.25	15.6	5 300	6 300	6016N	6016NR	120.22	2.87	3.25	0.6	134.7	2.77	86.5	118.5	136.5	5.39	1	0.5	0.850	6016N
	140	26	2	0.5	90.9	53.0	3.25	14.6	4 500	5 400	6216N	6216NR	135.23	4.9	3.25	0.6	149.7	2.77	89	131	152	7.37	2	0.5	1.40	6216N
	170	39	2.1	0.5	154	86.7	5.85	13.3	3 900	4 700	6316N	6316NR	163.65	5.69	3.65	0.6	182.9	3.05	91	159	185	8.44	2	0.5	3.59	6316N
85	130	22	1.1	0.5	61.8	43.1	2.35	15.8	5 000	5 900	6017N	6017NR	125.22	2.87	3.25	0.6	139.7	2.77	91.5	123.5	141.5	5.39	1	0.5	0.890	6017N
	150	28	2	0.5	105	61.9	3.70	14.5	4 200	5 000	6217N	6217NR	145.24	4.9	3.25	0.6	159.7	2.77	94	141	162	7.37	2	0.5	1.79	6217N
	180	41	3	0.5	166	96.8	6.35	13.3	3 700	4 400	6317N	6317NR	173.66	5.69	3.65	0.6	192.9	3.05	98	167	195	8.44	2.5	0.5	4.23	6317N
90	140	24	1.5	0.5	72.8	49.7	2.65	15.6	4 700	5 600	6018N	6018NR	135.23	3.71	3.25	0.6	149.7	2.77	98	132	152	6.17	1.5	0.5	1.16	6018N
	160	30	2	0.5	120	71.5	4.20	14.5	3 900	4 700	6218N	6218NR	155.22	4.9	3.25	0.6	169.7	2.77	99	151	172	7.37	2	0.5	2.15	6218N
	190	43	3	0.5	178	107	8.80	13.3	3 500	4 200	6318N	6318NR	183.64	5.69	3.65	0.6	202.9	3.05	103	177	205	8.44	2.5	0.5	4.91	6318N
95	145	24	1.5	0.5	75.5	53.9	2.75	15.8	4 400	5 200	6019N	6019NR	140.23	3.71	3.25	0.6	154.7	2.77	103	137	157	6.17	1.5	0.5	1.21	6019N
	170	32	2.1	0.5	136	81.9	4.65	14.4	3 700	4 400	6219N	6219NR	163.65	5.69	3.65	0.6	182.9	3.05	106	159	185	8.44	2	0.5	2.62	6219N
	200	45	3	0.5	191	119	9.45	13.3	3 300	4 000	6319N	6319NR	193.65	5.69	3.65	0.6	212.9	3.05	108	187	215	8.44	2.5	0.5	5.67	6319N
100	150	24	1.5	0.5	75.2	54.2	2.70	15.9	4 300	5 100	6020N	6020NR	145.24	3.71	3.25	0.6	159.7	2.77	108	142	162	6.17	1.5	0.5	1.25	6020N
	180	34	2.1	0.5	153	93.1	5.15	14.4	3 500	4 200	6220N	6220NR	173.66	5.69	3.65	0.6	192.9	3.05	111	169	195	8.44	2	0.5	3.14	6220N
105	160	26	2	0.5	90.4	65.8	3.20	15.8	4 000	4 700	6021N	6021NR	155.22	3.71	3.25	0.6	169.7	2.77	114	151	172	6.17	2	0.5	1.59	6021N
	190	36	2.1	0.5	166	105	5.70	14.4	3 300	3 900	6221N	6221NR	183.64	5.69	3.65	0.6	202.9	3.05	116	179	205	8.44	2	0.5	3.70	6221N
110	170	28	2	0.5	103	73.0	3.55	15.6	3 800	4 500	6022N	6022NR	163.65	3.71	3.65	0.6	182.9	3.05	119	161	185	6.45	2	0.5	1.96	6022N
	200	38	2.1	0.5	180	117	6.20	14.4	3 100	3 700	6222N	6222NR	193.65	5.69	3.65	0.6	212.9	3.05	121	189	215	8.44	2	0.5	4.36	6222N
120	180	28	2	0.5	106	79.3	3.60	15.9	3 600	4 200	6024N	6024NR	173.66	3.71	3.65	0.6	192.9	3.05	129	171	195	6.45	2	0.5	2.07	6024N
130	200	33	2	0.5	133	101	4.45	15.8	3 200	3 800	6026N	6026NR	193.65	5.69	3.65	0.6	212.9	3.05	139	191	215	8.44	2	0.5	3.16	6026N

[Remark] Standard cage types used for the above bearings are described earlier in this section.

Extra-small ball bearings, miniature ball bearings

d 1 ~ (4) mm

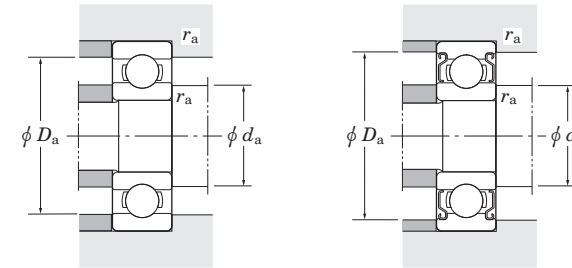
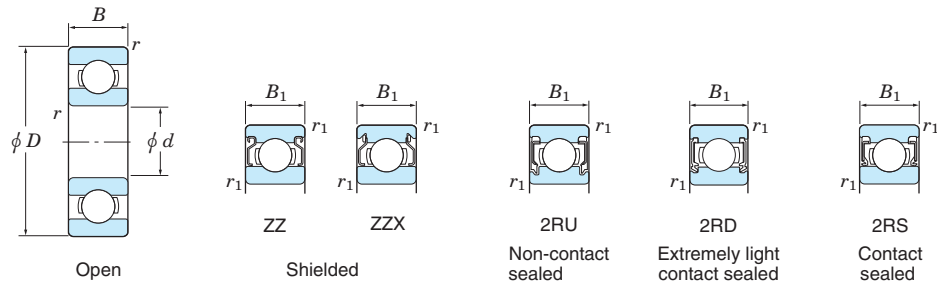


Boundary dimensions (mm)						Basic load ratings (kN)		Fatigue load limit (kN) C <sub>u</sub>	Factor f <sub>0</sub>	Limiting speeds (min <sup>-1</sup> )				Bearing No.					Mounting dimensions (mm)			(Refer.) Mass (g)
d	D	B	B <sub>1</sub>	r <sup>(1)</sup> min.	r <sub>1</sub> <sup>(1)</sup> min.	C <sub>r</sub>	C <sub>0r</sub>			Grease lub.	Oil lub.	Open [ZZ, 2RU]	(2RD) min.	(2RS)	Open [Z]	Open	Shielded	Non-contact sealed	Extremely light shielded	Contact sealed	d <sub>a</sub> min.	
1	3	1	—	0.07	—	0.120	0.03	0.0007	11.6	130 000	—	—	150 000	681	—	—	—	—	1.6	2.4	0.05	0.03
	3	1.5	—	0.08	—	0.100	0.02	0.0006	12.8	130 000	—	—	150 000	ML1003	—	—	—	—	1.6	2.4	0.07	0.05
	4	1.6	—	0.1	—	0.170	0.04	0.001	11.4	120 000	—	—	140 000	691	—	—	—	—	1.8	3.2	0.1	0.1
1.2	4	1.8	—	0.08	—	0.140	0.03	0.0009	11.4	120 000	—	—	140 000	ML1204	—	—	—	—	1.8	3.4	0.07	0.1
1.5	4	1.2	2	0.1	0.1	0.140	0.03	0.0009	13.2	120 000	—	—	140 000	68/1.5	W68/1.5 ZZ	—	—	—	2.3	3.2	0.1	0.1
	5	2	2.6	0.15	0.15	0.300	0.07	0.002	13.3	110 000	—	—	130 000	69/1.5	W69/1.5 ZZX	—	—	—	2.7	3.8	0.15	0.1
	6	2.5	3	0.1	0.1	0.410	0.10	0.003	11.4	86 000	—	—	100 000	ML1506	WML1506 ZZX	—	—	—	2.3	5.2	0.1	0.3
2	5	1.5	2.3	0.1	0.1	0.210	0.05	0.001	13.3	98 000	—	—	110 000	682	W682 ZZX	—	—	—	2.8	4.4	0.1	0.1
	5	2	2.5	0.1	0.08	0.210	0.05	0.001	13.3	98 000	—	—	110 000	ML2005	WML2005 ZZ	—	—	—	2.6	4.2	0.07	0.1
	6	2.3	3	0.15	0.1	0.410	0.10	0.003	11.4	86 000	—	—	100 000	692	W692 ZZ	—	—	—	3.2	4.8	0.1	0.2
	6	2.5	3	0.1	0.1	0.410	0.10	0.003	11.4	86 000	—	—	100 000	ML2006	WML2006 ZZX	—	—	—	2.8	5.2	0.1	0.3
	7	2.5	3	0.15	0.15	0.480	0.13	0.003	12.6	67 000	—	—	79 000	ML2007	WML2007 ZZX	—	—	—	3.2	5.8	0.15	0.4
	7	2.8	3.5	0.15	0.15	0.480	0.13	0.003	12.6	67 000	—	—	79 000	602	W602 ZZX	—	—	—	3.2	5.8	0.15	0.5
2.5	6	1.8	2.6	0.1	0.1	0.240	0.06	0.002	14.3	75 000	—	—	89 000	68/2.5	W68/2.5 ZZ	—	—	—	3.3	5.2	0.1	0.2
	7	2.5	3.5	0.15	0.15	0.390	0.11	0.003	13.7	66 000	—	—	79 000	69/2.5	W69/2.5 ZZ	—	—	—	3.7	5.8	0.15	0.4
	8	2.5	—	0.1	—	0.540	0.15	0.004	13.4	63 000	—	—	75 000	ML2508/1B	—	—	—	—	3.3	7.2	0.1	0.6
	8	2.8	4	0.15	0.1	0.680	0.17	0.005	11.5	64 000	—	—	76 000	ML2508	WML2508 ZZX	—	—	—	3.7	6.8	0.1	0.6
3	6	2	2.5	0.08	0.05	0.240	0.06	0.002	14.3	75 000	—	—	89 000	ML3006	WML3006 ZZ	—	—	—	3.6	5.4	0.05	0.2
	7	2	3	(0.15)	(0.15)	0.390	0.11	0.003	13.7	66 000	—	—	79 000	683	W683 ZZ	—	—	—	4.2	5.8	0.1	0.3
	8	2.5	—	0.1	—	0.490	0.14	0.004	13.4	63 000	—	—	75 000	ML3008	—	—	—	—	3.8	7.2	0.1	0.5
	8	3	4	0.15	0.15	0.680	0.17	0.005	11.5	64 000	—	—	76 000	693	W693 ZZ	—	—	—	4.2	6.8	0.15	0.6
	9	3	5	0.15	0.15	0.540	0.16	0.004	14.0	60 000	—	—	72 000	603	W603 ZZX	—	—	—	4.2	7.8	0.15	0.9
	10	4	4	0.15	0.15	0.800	0.22	0.006	12.8	52 000	—	44 000	63 000	623	623 ZZ	—	—	623 2RS	4.2	8.8	0.15	1.6
	13	5	5	0.2	0.2	1.65	0.49	0.01	12.3	44 000	—	—	54 000	633	633 ZZ	—	—	—	4.6	11.4	0.2	3.0
4	7	2	2.5	0.08	0.05	0.320	0.11	0.003	15.1	64 000	—	—	76 000	ML4007	WML4007 ZZ	—	—	—	4.6	6.4	0.05	0.2
	8	2	3	0.1	0.08	0.490	0.14	0.004	14.6	61 000	—	—	73 000	ML4008	WML4008 ZZ	—	—	—	4.8	7.2	0.08	0.4
	9	2.5	4	(0.15)	(0.15)	0.800	0.23	0.006	12.8	59 000	—	—	70 000	684	W684 ZZ	—	—	—	5.2	7.8	0.1	0.6

[Note] 1) Numerical values in ( ) do not conform to JIS B 1521.

Extra-small ball bearings, miniature ball bearings

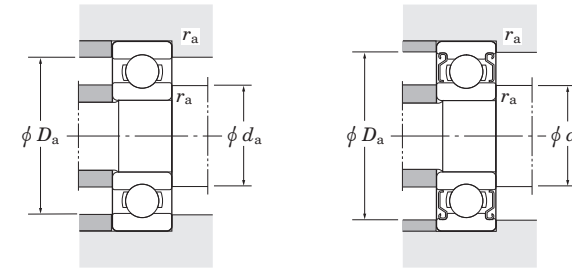
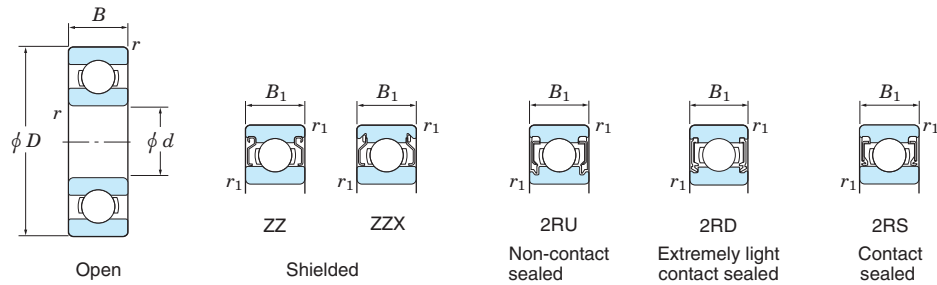
d (4) ~ (7) mm



Boundary dimensions (mm)			Basic load ratings (kN)		Fatigue load limit (kN) C <sub>u</sub>	Factor f <sub>0</sub>	Limiting speeds (min <sup>-1</sup> )				Bearing No.					Mounting dimensions (mm)			(Refer.) Mass (g)			
d	D	B	B <sub>1</sub>	r <sub>min.</sub>			r <sub>1 min.</sub>	C <sub>r</sub>	C <sub>0r</sub>	Grease lub.		Oil lub.		Open	Shielded	Non-contact sealed	Extremely light shielded	Contact sealed		d <sub>a min.</sub>	D <sub>a max.</sub>	r <sub>a max.</sub>
4	10	3	4	0.15	0.1	0.810	0.23	0.006	13.3	56 000	—	—	67 000	ML4010	WML4010 ZZ	—	—	—	5.2	8.8	0.1	1.0
	11	4	4	0.15	0.15	1.20	0.35	0.009	12.4	54 000	—	44 000	65 000	694	694 ZZ	694 2RU	—	694 2RS	5.2	9.8	0.15	1.8
	12	4	4	0.2	0.2	1.20	0.35	0.009	12.4	53 000	—	—	63 000	604	604 ZZ	—	—	—	5.6	10.4	0.2	2.1
	13	5	5	0.2	0.2	1.65	0.48	0.010	12.3	44 000	—	39 000	54 000	624	624 ZZ	624 2RU	—	624 2RS	5.6	11.4	0.2	2.9
	16	5	5	0.3	0.3	1.70	0.52	0.010	12.4	40 000	—	—	49 000	634	634 ZZ	—	—	—	6	14	0.3	5.3
5	8	2	2.5	0.08	0.05	0.270	0.09	0.002	15.7	59 000	—	—	70 000	ML5008	WML5008 ZZ	—	—	—	5.6	7.4	0.05	0.3
	9	2.5	3	0.1	0.08	0.540	0.17	0.004	15.3	56 000	—	—	67 000	ML5009	WML5009 ZZ	—	—	—	5.8	8.2	0.08	0.5
	10	3	4	0.1	0.1	0.540	0.17	0.005	14.8	55 000	—	—	65 000	ML5010	WML5010 ZZ	—	—	—	5.8	9	0.1	0.9
	11	3	5	0.15	0.15	0.890	0.28	0.007	12.8	53 000	—	—	63 000	685	W685 ZZ	—	—	—	6.2	9.8	0.15	1.0
	13	4	4	0.2	0.2	1.35	0.43	0.010	12.3	50 000	45 000	42 000	60 000	695	695 ZZ	695 2RU	695 2RD	695 2RS	6.6	11.4	0.2	2.2
	14	5	5	0.2	0.2	1.65	0.49	0.010	12.3	50 000	—	—	60 000	605	605 ZZ	—	—	—	6.6	12.4	0.2	3.5
	16	5	5	0.3	0.3	2.15	0.67	0.030	12.4	40 000	36 000	33 000	49 000	625	625 ZZ	625 2RU	—	625 2RS	7	14	0.3	5.0
	19	6	6	0.3	0.3	2.90	0.89	0.040	12.3	35 000	32 000	27 000	43 000	635	635 ZZ	635 2RU	—	635 2RS	7	17	0.3	8.5
6	10	2.5	3	0.1	0.08	0.620	0.22	0.006	15.7	53 000	—	—	63 000	ML6010	WML6010 ZZ	—	—	—	6.8	9.2	0.08	0.6
	12	3	4	0.15	0.1	0.890	0.29	0.008	14.5	49 000	—	37 000	59 000	ML6012	WML6012 ZZ	—	—	WML6012 2RS	7.2	10.8	0.1	1.3
	13	3.5	5	0.15	0.15	1.35	0.44	0.010	13.7	48 000	43 000	36 000	57 000	686	W686 ZZ	—	—	W686 2RS	7.2	11.8	0.15	1.8
	15	5	5	0.2	0.2	1.70	0.52	0.010	12.4	45 000	41 000	32 000	54 000	696	696 ZZ	696 2RU	696 2RD	696 2RS	7.6	13.4	0.2	3.9
	17	6	6	0.3	0.3	2.45	0.74	0.030	12.2	43 000	39 000	—	51 000	606	606 ZZ	606 2RU	606 2RD	—	8	15	0.3	5.8
	19	6	6	0.3	0.3	2.90	0.89	0.040	12.3	35 000	32 000	27 000	43 000	626	626 ZZ	626 2RU	626 2RD	626 2RS	8	17	0.3	8.1
	19	8	8	0.3	0.3	3.25	1.05	0.04	12.3	40 000	—	—	47 000	ML6019	ML6019 ZZ	—	—	—	7	18	0.3	9.0
	22	7	7	0.3	0.3	4.10	1.35	0.060	12.4	31 000	—	23 000	37 000	636	636 ZZ	—	—	636 2RS	8	20	0.3	13
7	11	2.5	3	0.1	0.08	0.540	0.23	0.006	16.1	49 000	—	—	59 000	ML7011	WML7011 ZZ	—	—	—	7.8	10.2	0.08	0.7
	13	3	4	0.15	0.15	0.680	0.28	0.007	14.9	47 000	—	—	55 000	ML7013	WML7013 ZZ	—	—	—	8.2	11.8	0.15	1.4
	14	3.5	5	0.15	0.15	1.45	0.51	0.010	14.2	45 000	—	—	54 000	687	W687 ZZ	—	—	—	8.2	12.8	0.15	2.0
	17	5	5	0.3	0.3	2.00	0.71	0.02	14.0	42 000	—	28 000	50 000	697	697 ZZ	—	—	697 2RS	9	15	0.3	5.3
	19	6	6	0.3	0.3	2.95	0.89	0.040	12.3	40 000	36 000	27 000	47 000	607	607 ZZ	607 2RU	607 2RD	607 2RS	9	17	0.3	7.6
	22	7	7	0.3	0.3	4.10	1.35	0.060	12.4	31 000	28 000	23 000	37 000	627	627 ZZ	627 2RU	627 2RD	627 2RS	9	20	0.3	13
	22	8	8	0.3	0.3	4.10	1.35	0.06	12.4	34 000	—	—	41 000	ML7022	ML7022 ZZ	—	—	—	9	20	0.3	14

Extra-small ball bearings, miniature ball bearings

d (7) ~ 9 mm

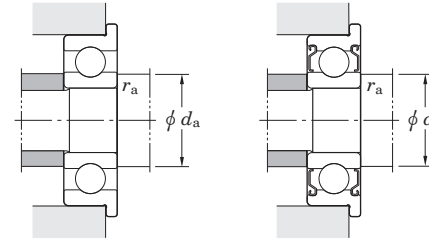
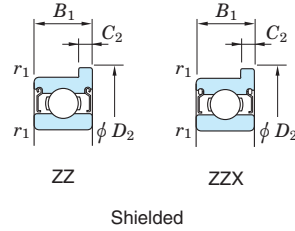
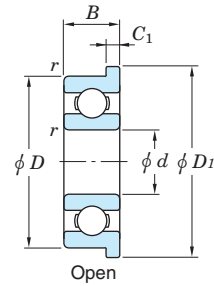


Boundary dimensions (mm)						Basic load ratings (kN)		Fatigue load limit (kN) Cu	Factor f0	Limiting speeds (min <sup>-1</sup> )				Bearing No.					Mounting dimensions (mm)			Mass (g) (Refer.)	
d	D	B	B1	r <sup>(1)</sup> min.	r <sup>(1)</sup> min.	Cr	C0r			Grease lub.	Oil lub.	Open ZZ, 2RU	(2RD)	(2RS)	Open Z	Open	Shielded	Non-contact sealed	Extremely light shielded	Contact sealed	da min.		Da max.
7	26	9	9	0.3	0.3	5.65	1.95	0.100	12.3	26 000	—	—	32 000	637	637 ZZ	—	—	—	9	24	0.3	24	
	8	12	2.5	3.5	0.1	0.08	0.680	0.27	0.007	16.4	47 000	—	—	55 000	ML8012	WML8012 ZZ	—	—	—	8.8	11.2	0.08	0.8
		14	3.5	4	0.15	0.15	1.00	0.39	0.010	15.3	44 000	—	—	52 000	ML8014	WML8014 ZZ	—	—	—	9.2	12.8	0.15	1.8
		16	4	5	0.2	0.2	1.55	0.59	0.020	14.0	42 000	38 000	28 000	50 000	688	W688 ZZ	W688 2RU	W688 2RD	W688 2RS	9.6	14.4	0.2	3.2
		19	6	6	0.3	0.3	2.80	0.91	0.040	12.9	39 000	35 000	27 000	46 000	698	698 ZZ	—	698 2RD	698 2RS	10	17	0.3	7.2
		22	7	7	0.3	0.3	4.10	1.35	0.060	12.4	34 000	31 000	23 000	41 000	608	608 ZZ	608 2RU	608 2RD	608 2RS	10	20	0.3	12
24	8	8	0.3	0.3	4.15	1.40	0.060	12.8	28 000	—	22 000	35 000	628	628 ZZ	628 2RU	—	628 2RS	10	22	0.3	18		
28	9	9	0.3	0.3	5.65	1.95	0.100	12.3	26 000	23 000	—	32 000	638	638 ZZ	—	638 2RD	—	10	26	0.3	29		
9	17	4	5	0.2	0.2	1.65	0.66	0.020	14.9	39 000	35 000	—	46 000	689	W689 ZZ	W689 2RU	W689 2RD	—	10.6	15.4	0.2	3.5	
	20	6	6	0.3	0.3	3.10	1.05	0.040	13.3	35 000	32 000	25 000	42 000	699	699 ZZ	—	699 2RD	699 2RS	11	18	0.3	7.5	
	24	7	7	0.3	0.3	4.15	1.40	0.060	12.8	33 000	30 000	22 000	40 000	609	609 ZZ	609 2RU	609 2RD	609 2RS	11	22	0.3	15	
	26	8	8	(0.6)	(0.6)	5.70	1.95	0.100	12.4	27 000	24 000	19 000	33 000	629	629 ZZ	629 2RU	629 2RD	629 2RS	12.1	22	0.3	20	
	30	10	10	0.6	0.6	7.50	2.65	0.210	12.3	24 000	—	—	29 000	639	639 ZZ	—	—	—	13	26	0.6	35	

[Note] 1) Numerical values in ( ) do not conform to JIS B 1521.

Extra-small ball bearings, miniature ball bearings  
flanged type

$d$  1 ~ (4) mm

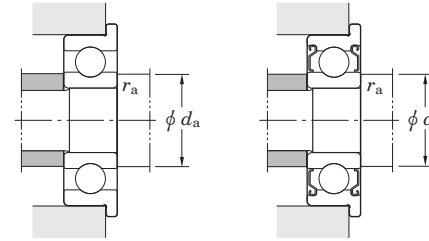
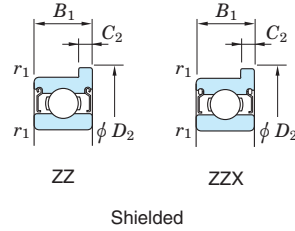
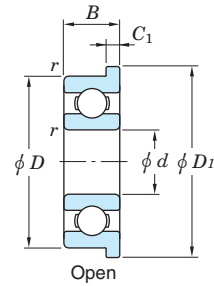


Boundary dimensions (mm)					Basic load ratings (kN)		Fatigue load limit	Factor	Limiting speeds (min <sup>-1</sup> )		Bearing No.	Dimensions of flange (mm)				Mounting dimensions (mm)		(Refer.) Mass (g)		
$d$	$D$	$B$	$B_1$	$r_1^{1)}$ min.	$r_1^{1)}$ min.	$C_r$	$C_{0r}$	(kN) $C_u$	$f_0$	Grease lub.		Oil lub.	$D_1$	$D_2$	$C_1$	$C_2$	$d_a$ min.		$r_a$ max.	
											Open	Shielded								
											[Open] ZZ, ZZX	[Open] Z, ZX								
1	3	1	—	0.07	—	0.120	0.03	0.0007	11.6	130 000	150 000	F681					1.6	0.05	0.03	
	4	1.6	—	0.1	—	0.170	0.04	0.001	11.4	120 000	140 000		F691					1.8		0.1
1.5	4	1.2	2	0.1	0.1	0.140	0.03	0.0009	13.2	120 000	140 000	F68/1.5					2.3	0.1	0.1	
	5	2	2.6	0.15	0.15	0.300	0.07	0.002	12.9	110 000	120 000	F69/1.5	6.5	6.5	0.6	0.8	2.7	0.15		0.2
	6	2.5	3	0.1	0.1	0.410	0.10	0.003	11.4	86 000	100 000	MLF1506	7.5	7.5	0.6	0.8	2.3	0.1		
2	5	1.5	2.3	0.1	0.1	0.210	0.05	0.001	13.3	99 000	120 000	F682					2.8	0.1	0.1	
	5	2	2.5	0.1	0.08	0.210	0.05	0.001	12.9	99 000	120 000	MLF2005	6.2	6.2	0.6	0.6	2.8	0.07		0.2
	6	2.3	3	0.15	0.1	0.410	0.10	0.003	11.4	86 000	100 000	F692	7.5	7.5	0.6	0.8	3.2	0.1		
	6	2.5	3	0.1	0.1	0.410	0.10	0.003	11.4	86 000	100 000	MLF2006	7.2	7.2	0.6	0.6	2.8	0.1		0.4
	7	2.5	3	0.15	0.15	0.480	0.13	0.003	12.6	67 000	79 000	MLF2007	8.2	8.2	0.6	0.6	3.2	0.15		
	7	2.8	3.5	0.15	0.15	0.480	0.13	0.003	12.6	67 000	79 000	F602	8.5	8.5	0.7	0.9	3.2	0.15		
	2.5	6	1.8	2.6	0.1	0.1	0.260	0.07	0.002	14.3	69 000	82 000	F68/2.5					3.3		0.1
7		2.5	3.5	0.15	0.15	0.480	0.13	0.003	12.7	66 000	79 000	F69/2.5	8.5	8.5	0.7	0.9	3.7	0.15	0.5	
8		2.5	—	0.1	—	0.680	0.17	0.005	11.7	63 000	75 000	MLF2508/1B					3.5	0.1		0.7
8		2.8	4	0.15	0.1	0.680	0.17	0.005	11.5	63 000	75 000	MLF2508	9.5	9.5	0.7	0.9	3.7	0.1		
3	6	2	2.5	0.08	0.05	0.260	0.07	0.002	14.3	69 000	82 000	MLF3006	7.2	7.2	0.6	0.6	3.6	0.05	0.2	
	7	2	3	(0.15)	(0.15)	0.390	0.11	0.003	14.0	65 000	78 000	F683	8.1	8.1	0.5	0.8	4.2	0.1		0.4
	8	2.5	—	0.1	—	0.490	0.14	0.004	13.4	61 000	72 000	MLF3008					4.0	0.1		
	8	3	4	0.15	0.15	0.690	0.18	0.005	11.9	63 000	75 000	F693	9.5	9.5	0.7	0.9	4.2	0.15		0.7
	9	3	5	0.15	0.15	0.710	0.19	0.005	12.4	60 000	72 000	F603	10.5	10.5	0.7	1	4.2	0.15		
	10	4	4	0.15	0.15	0.800	0.22	0.006	12.4	61 000	72 000	F623	11.5	11.5	1	1	4.2	0.15		
4	7	2	2.5	0.08	0.05	0.320	0.11	0.003	15.1	63 000	75 000	MLF4007	8.2	8.2	0.6	0.6	4.6	0.05	0.3	
	8	2	3	0.1	0.08	0.490	0.14	0.004	13.9	61 000	72 000	MLF4008	9.2	9.2	0.6	0.6	4.8	0.08		0.5
	9	2.5	4	(0.15)	(0.15)	0.800	0.23	0.006	12.8	59 000	70 000	F684	10.3	10.3	0.6	1	5.2	0.1		
	10	3	4	0.15	0.1	0.880	0.27	0.007	13.5	56 000	66 000	MLF4010	11.2	11.6	0.6	0.8	5.2	0.1		1.1
	11	4	4	0.15	0.15	1.20	0.35	0.009	12.4	54 000	65 000	F694	12.5	12.5	1	1	5.2	0.15		
	12	4	4	0.2	0.2	1.20	0.35	0.009	12.4	54 000	65 000	F604	13.5	13.5	1	1	5.6	0.2		

[Note] 1) Numerical values in ( ) do not conform to JIS B 1521.

Extra-small ball bearings, miniature ball bearings  
flanged type

$d$  (4) ~ 8 mm

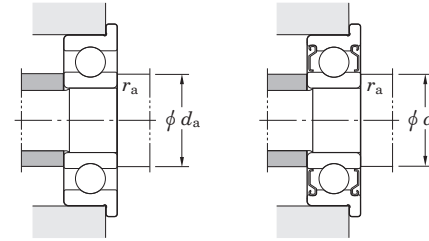
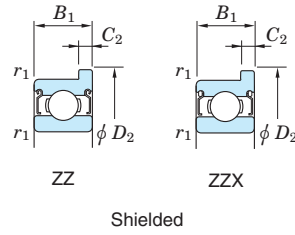
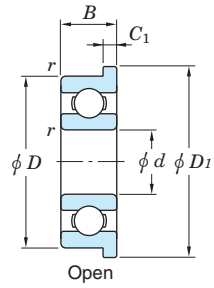


Boundary dimensions (mm)					Basic load ratings (kN)		Fatigue load limit (kN) $C_u$	Factor $f_0$	Limiting speeds ( $\text{min}^{-1}$ )		Bearing No.	Dimensions of flange (mm)				Mounting dimensions (mm)		(Refer.) Mass (g)		
$d$	$D$	$B$	$B_1$	$r_{\text{min}}$	$r_1_{\text{min}}$	$C_r$			$C_{0r}$	Grease lub.		Oil lub.	Open	Shielded	$D_1$	$D_2$	$C_1$		$C_2$	$d_a_{\text{min}}$
4	13	5	5	0.2	0.2	0.010	0.48	1.65	12.2	50 000	60 000	F624 F634	F624 ZZ F634 ZZ	15	15	1	1	5.6	0.2	3.3
	16	5	5	0.3	0.3	0.010	0.52	1.70	13.0	47 000	55 000			18	18	1	1	6	0.3	5.7
5	8	2	2.5	0.08	0.05	0.270	0.09	0.002	15.8	59 000	70 000	MLF5008 MLF5009 MLF5010	WMLF5008 ZZ WMLF5009 ZZ WMLF5010 ZZ	9.2	9.2	0.6	0.6	5.6	0.05	0.4
	9	2.5	3	0.1	0.08	0.540	0.17	0.004	14.6	57 000	67 000			10.2	10.2	0.6	0.6	5.8	0.08	0.6
	10	3	4	0.1	0.1	0.540	0.17	0.005	14.8	57 000	67 000			11.2	11.6	0.6	0.8	5.8	0.1	1.0
	11	3	5	0.15	0.15	0.890	0.28	0.007	14.0	53 000	63 000	F685 F695 F605	WF685 ZZ F695 ZZ F605 ZZ	12.5	12.5	0.8	1	6.2	0.15	1.1
	13	4	4	0.2	0.2	1.35	0.43	0.010	13.4	49 000	59 000			15	15	1	1	6.6	0.2	2.5
	14	5	5	0.2	0.2	1.65	0.51	0.01	12.3	48 000	57 000	F625 F635	F625 ZZ F635 ZZ	16	16	1	1	6.6	0.2	3.9
	16	5	5	0.3	0.3	2.15	0.67	0.03	12.4	45 000	54 000			18	18	1	1	7	0.3	5.4
	19	6	6	0.3	0.3	2.90	0.89	0.04	12.3	40 000	47 000			22	22	1.5	1.5	7	0.3	9.7
6	10	2.5	3	0.1	0.08	0.620	0.22	0.006	15.2	53 000	63 000	MLF6010 MLF6012 F686	WMLF6010 ZZ WMLF6012 ZZ WF686 ZZ	11.2	11.2	0.6	0.6	6.8	0.08	0.7
	12	3	4	0.15	0.1	0.890	0.29	0.008	14.5	49 000	59 000			13.2	13.6	0.6	0.8	7.2	0.1	1.4
	13	3.5	5	0.15	0.15	1.35	0.44	0.010	13.7	48 000	57 000			15	15	1	1.1	7.2	0.15	2.1
	15	5	5	0.2	0.2	1.70	0.52	0.01	13.0	47 000	55 000	F696 F606 F626 F636	F696 ZZ F606 ZZ F626 ZZ F636 ZZ	17	17	1.2	1.2	7.6	0.2	4.3
	17	6	6	0.3	0.3	2.85	0.84	0.03	11.4	43 000	52 000			19	19	1.2	1.2	8	0.3	6.3
	19	6	6	0.3	0.3	2.90	0.89	0.04	12.3	40 000	47 000			22	22	1.5	1.5	8	0.3	9.2
	22	7	7	0.3	0.3	4.10	1.35	0.06	12.4	34 000	41 000			25	25	1.5	1.5	8	0.3	14
7	11	2.5	3	0.1	0.08	0.570	0.20	0.005	15.6	49 000	59 000	MLF7011 MLF7013 F687	WMLF7011 ZZ WMLF7013 ZZ WF687 ZZ	12.2	12.2	0.6	0.6	7.8	0.08	0.8
	13	3	4	0.15	0.15	0.680	0.28	0.007	16.0	46 000	55 000			14.2	14.6	0.6	0.8	8.2	0.15	1.5
	14	3.5	5	0.15	0.15	1.45	0.51	0.010	14.2	45 000	54 000			16	16	1	1.1	8.2	0.15	2.4
	17	5	5	0.3	0.3	2.00	0.71	0.02	14.0	42 000	50 000	F697 F607 F627	F697 ZZ F607 ZZ F627 ZZ	19	19	1.2	1.2	9	0.3	5.8
	19	6	6	0.3	0.3	2.95	0.89	0.04	12.1	40 000	47 000			22	22	1.5	1.5	9	0.3	8.7
	22	7	7	0.3	0.3	4.10	1.35	0.06	12.4	34 000	41 000			25	25	1.5	1.5	9	0.3	14
8	12	2.5	3.5	0.1	0.08	0.680	0.27	0.007	15.9	47 000	55 000	MLF8012 MLF8014 F688	WMLF8012 ZZ WMLF8014 ZZ WF688 ZZ	13.2	13.6	0.6	0.8	8.8	0.08	0.9
	14	3.5	4	0.15	0.15	1.00	0.42	0.01	15.3	44 000	52 000			15.6	15.6	0.8	0.8	9.2	0.15	2.0
	16	4	5	0.2	0.2	1.55	0.59	0.020	14.8	42 000	50 000	F698 F608	F698 ZZ F608 ZZ	18	18	1	1.1	9.6	0.2	3.6
	19	6	6	0.3	0.3	2.80	0.91	0.040	12.9	39 000	46 000			22	22	1.5	1.5	10	0.3	8.3
	22	7	7	0.3	0.3	4.10	1.35	0.060	12.4	34 000	41 000			25	25	1.5	1.5	10	0.3	13



Extra-small ball bearings, miniature ball bearings  
flanged type

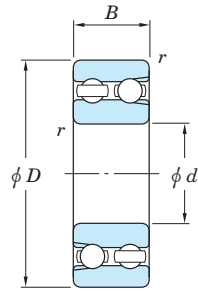
$d$  9 mm



Boundary dimensions (mm)					Basic load ratings (kN)		Fatigue load limit (kN) $C_u$	Factor $f_0$	Limiting speeds ( $\text{min}^{-1}$ )		Bearing No.	Dimensions of flange (mm)				Mounting dimensions (mm)		(Refer.) Mass (g)		
$d$	$D$	$B$	$B_1$	$r_{\text{min.}}$	$r_1_{\text{min.}}$	$C_r$			$C_{0r}$	Grease lub.		Oil lub.	Open	Shielded	$D_1$	$D_2$	$C_1$		$C_2$	$d_a_{\text{min.}}$
9	17	4	5	0.2	0.2	1.65	0.66	0.020	15.1	39 000	46 000	F689 F699 F609	WF689 ZZ F699 ZZ F609 ZZ	19	19	1	1.1	10.6	0.2	3.9
	20	6	6	0.3	0.3	3.10	1.05	0.04	13.3	37 000	44 000			23	23	1.5	1.5	11	0.3	8.7
	24	7	7	0.3	0.3	4.15	1.45	0.06	12.8	32 000	38 000			27	27	1.5	1.5	11	0.3	16

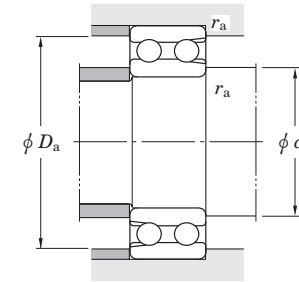
Double-row deep groove ball bearings

$d$  10 ~ (60) mm



Boundary dimensions (mm)				Basic load ratings (kN)		Fatigue load limit (kN) $C_u$	Factor $f_0$	Limiting speeds ( $\text{min}^{-1}$ )		Bearing No.	Mounting dimensions (mm)			(Refer.) Mass (kg)
$d$	$D$	$B$	$r_{\text{min.}}$	$C_r$	$C_{0r}$			Grease lub.	Oil lub.		$d_a$ min.	$D_a$ max.	$r_a$ max.	
10	30	14	0.6	9.61	5.90	0.300	13.0	15 000	20 000	<b>4200</b>	14	26	0.6	0.057
12	32	14	0.6	9.71	6.15	0.320	13.6	14 000	18 000	<b>4201</b>	16	28	0.6	0.062
15	35	14	0.6	12.2	9.00	0.460	14.2	12 000	16 000	<b>4202</b>	19	31	0.6	0.071
	42	17	1	16.4	11.7	0.830	13.7	11 000	14 000	<b>4302</b>	20	37	1	0.123
17	40	16	0.6	14.6	10.4	0.710	14.1	11 000	14 000	<b>4203</b>	21	36	0.6	0.106
	47	19	1	20.6	15.0	1.05	13.7	9 400	13 000	<b>4303</b>	22	42	1	0.171
20	47	18	1	20.5	16.0	1.10	14.2	9 000	12 000	<b>4204</b>	25	42	1	0.165
	52	21	1.1	24.3	17.0	1.25	13.5	8 300	11 000	<b>4304</b>	26.5	45.5	1	0.227
25	52	18	1	20.4	16.9	1.05	15.0	7 500	9 900	<b>4205</b>	30	47	1	0.189
	62	24	1.1	32.9	25.7	1.75	14.1	6 700	9 000	<b>4305</b>	31.5	55.5	1	0.365
30	62	20	1	27.4	24.7	1.50	15.1	6 400	8 500	<b>4206</b>	35	57	1	0.298
	72	27	1.1	44.4	35.9	2.45	14.0	5 700	7 600	<b>4306</b>	36.5	65.5	1	0.542
35	72	23	1.1	33.0	30.7	1.85	15.2	5 600	7 400	<b>4207</b>	41.5	65.5	1	0.460
	80	31	1.5	50.7	41.8	2.85	14.1	5 200	7 000	<b>4307</b>	43	72	1.5	0.752
40	80	23	1.1	42.2	42.4	2.50	15.5	4 700	6 300	<b>4208</b>	46.5	73.5	1	0.558
	90	33	1.5	57.5	48.8	3.25	14.7	4 600	6 100	<b>4308</b>	48	82	1.5	1.01
45	85	23	1.1	39.8	43.9	2.45	15.8	4 600	6 100	<b>4209</b>	51.5	78.5	1	0.605
	100	36	1.5	72.0	62.4	4.20	14.3	4 100	5 500	<b>4309</b>	53	92	1.5	1.35
50	90	23	1.1	39.2	44.6	2.45	16.1	4 200	5 600	<b>4210</b>	56.5	83.5	1	0.651
	110	40	2	88.0	77.7	5.25	14.2	3 700	5 000	<b>4310</b>	59	101	2	1.80
55	100	25	1.5	46.5	54.1	2.95	16.1	3 800	5 000	<b>4211</b>	63	92	1.5	0.882
	120	43	2	105	94.4	6.40	14.2	3 400	4 600	<b>4311</b>	64	111	2	2.29
60	110	28	1.5	59.9	67.6	3.80	15.9	3 500	4 700	<b>4212</b>	68	102	1.5	1.20

$d$  (60) ~ 75 mm



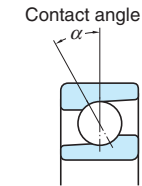
Boundary dimensions (mm)				Basic load ratings (kN)		Fatigue load limit (kN) $C_u$	Factor $f_0$	Limiting speeds ( $\text{min}^{-1}$ )		Bearing No.	Mounting dimensions (mm)			(Refer.) Mass (kg)
$d$	$D$	$B$	$r_{\text{min.}}$	$C_r$	$C_{0r}$			Grease lub.	Oil lub.		$d_a$ min.	$D_a$ max.	$r_a$ max.	
60	130	46	2.1	124	113	7.70	14.1	3 100	4 200	<b>4312</b>	71	119	2	2.87
65	120	31	1.5	68.3	78.5	4.35	15.9	3 200	4 300	<b>4213</b>	73	112	1.5	1.59
	140	48	2.1	134	124	8.20	14.3	2 900	3 900	<b>4313</b>	76	129	2	3.46
70	125	31	1.5	77.7	89.8	5.05	15.8	3 100	4 100	<b>4214</b>	78	117	1.5	1.68
	150	51	2.1	144	136	8.55	14.4	2 700	3 600	<b>4314</b>	81	139	2	4.21
75	130	31	1.5	77.0	90.7	4.95	16.0	2 900	3 900	<b>4215</b>	83	122	1.5	1.77
	160	55	2.1	166	158	9.70	14.4	2 500	3 400	<b>4315</b>	86	149	2	5.15

## Angular contact ball bearings

Angular contact ball bearings are suitable for applications which require high accuracy and good high-speed performance. This type of bearing is designed to carry a combined load.

- Single-row angular contact ball bearings and matched pair angular contact ball bearings

- The standard contact angles are 15°, 30° and 40°. They are identified, respectively, by the supplementary codes "C", "A" (omitted) and "B". Bearings with a smaller contact angle are more suitable for applications involving high-speed rotation. Those with a larger contact angle feature superior axial load resistance.



- Angular contact ball bearings are often preloaded to enhance their rigidity and rotating performance. (refer to p. A 112.)

For high-precision matched pair angular contact ball bearings of class 5 or higher, which are used in machine tools and other precision equipment, the standard preload is specified in three levels: slight (S), light (L), medium (M) and heavy (H). (refer to Table 11-2 on p. A 114.)

- When this type of bearing is loaded radially, an axial component of force is produced. In this case, two bearings are used together facing one another, or two or more bearings are matched and used. (refer to p. A 38.)
- Tables 1 and 2 list the different types of single-row and matched pair/stack angular contact ball bearings and describe their characteristics.

- Double-row angular contact ball bearings  
Consist of two single-row angular contact ball bearings matched back-to-back, with inner and outer rings integrated.  
Table 3 shows major types and their characteristics.

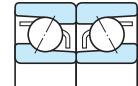
- Four-point contact ball bearings
  - Have a contact angle of 35° and an inner ring divided into two annular pieces. They are suitable for applications that involve either axial loading or combined loading, where the axial load makes up the major part of the load.
  - Able to support both axial load and a certain degree of radial load. Each rolling element is in contact with each of the inner and outer rings at a single point, and both contact points lie on the contact angle line. The line runs to either the right or left depending on the direction of the axial load.

### Single-row angular contact ball bearings



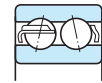
Bore diameter 10 – 380 mm

### Matched pair angular contact ball bearings



Bore diameter 10 – 380 mm

### Double-row angular contact ball bearings

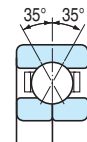


Bore diameter 10 – 110 mm

### Four-point contact ball bearings





Bore diameter 20 – 110 mm



- Consult with JTEKT when using the four-point contact ball bearing because application conditions such as load magnitude should be examined carefully.

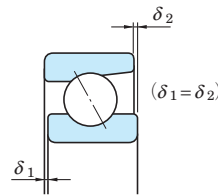


**Table 1 Single-row angular contact ball bearings**

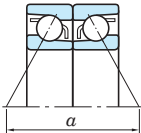
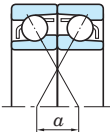
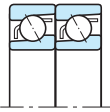
<p>Standard type</p>  <p>(with pressed cage)</p>  <p>(with machined cage)</p>	<ul style="list-style-type: none"> <li>Single-row angular contact ball bearings accommodate radial load and axial load in one direction.</li> <li>Bearings with a machined cage are suitable for high-speed applications.</li> </ul>
---	--

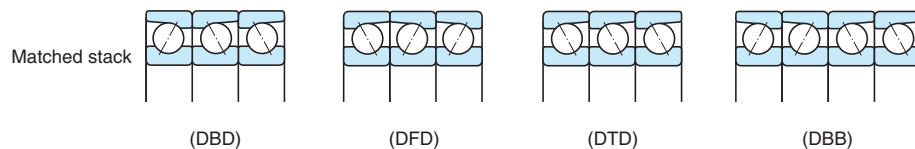
**Reference G-type bearing**

"G-type" bearings have a stand-out between the inner ring and outer ring on both sides that are equal in size. This arrangement is called "flush ground processing." These bearings can be matched in a variety of ways.

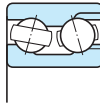
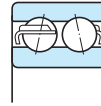
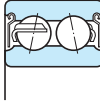
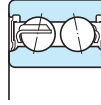


**Table 2 Matched pair and stack angular contact ball bearings**

<p>Back-to-back arrangement (DB)</p>		<ul style="list-style-type: none"> <li>Carries radial load and axial load in both directions.</li> <li>Suitable for applications involving moment loading because the distance between the load centers (<math>\alpha</math>) is long.</li> <li>As for the preloaded type, the clearance is pre-adjusted so that bearings will be preloaded the proper amount when the inner ring is fixed with a nut.</li> </ul>
<p>Face-to-face arrangement (DF)</p>		<ul style="list-style-type: none"> <li>Carries radial load and axial load in both directions.</li> <li>Has a smaller moment load accommodating capacity than the back-to-back arrangement, because the distance between the load centers (<math>\alpha</math>) is shorter.</li> <li>As for the preloaded type, the clearance is pre-adjusted so that bearings will be preloaded the proper amount when the outer rings are pressed together.</li> </ul>
<p>Tandem arrangement (DT)</p>		<ul style="list-style-type: none"> <li>Carries radial load and axial load in one direction.</li> <li>Suitable for applications which involve a high degree of axial loading.</li> </ul>



**Table 3 Double-row angular contact ball bearings**

 <p>(with filling slot) 32, 33</p>  <p>(without filling slot) 52, 53</p>  <p>Shielded 52...ZZ, 53...ZZ</p>  <p>Sealed 52...2RS, 53...2RS</p>	<ul style="list-style-type: none"> <li>Accommodates radial load and axial load in both directions. Also able to accommodate moment load. When installing bearings with filling slot (32 and 33 series), the raceway side without filling slot must accommodate main load.</li> <li>The 32 and 33 series are provided with a filling slot, while the 52 and 53 series are not.</li> <li>32 and 33 series : contact angle 32° 52 and 53 series : contact angle 24°</li> <li>Inferior to single-row and matched pair angular contact ball bearings in terms of high-speed and high accuracy performance.</li> <li>Shielded or sealed 52 and 53 series bearings are also available.</li> </ul>
--	--

<p>Boundary dimensions</p>	The dimensions of standard series are as specified in JIS B 1512.					
<p>Tolerances</p>	<p>· As specified in JIS B 1514-1. (refer to Table 7-3 on pp. A 60 – A 63.)</p> <p>· JTEKT has established "special tolerances" for bore diameter and outside diameter, as listed in the table to the right, to make it easy to produce high-precision matched stack bearings. Bearings which are produced based on these tolerances are identified by the supplementary code "K5."</p>					
<p><b>Special tolerances (K5) Unit : <math>\mu\text{m}</math></b></p>						
<p><b>Nominal bore diameter</b> <math>d</math> (mm)</p>		<p>Single plane mean bore diameter (<math>\Delta d_{mp}</math>) or single plane mean outside diameter deviation (<math>\Delta D_{mp}</math>)</p>				
		<p><b>class 5</b></p>		<p><b>class 4</b></p>		
over	up to	upper	lower	upper	lower	
–	50	– 1	– 4	– 1	– 3	
50	80	– 1	– 5	– 1	– 4	
80	120	– 1	– 5	– 1	– 4	
<p>Internal clearance</p>	<ul style="list-style-type: none"> <li>Matched pair bearing axial internal clearance.....(refer to Table 10-4 on p. A 103.)</li> <li>Double-row bearing radial internal clearance.....(refer to Table 10-5 on p. A 104.)</li> </ul>					
<p>Recommended fits</p>	<ul style="list-style-type: none"> <li>Classes 0 and 6 bearings.....(refer to Table 9-4 on pp. A 91, 92.)</li> <li>Classes 5 and 4 bearings.....as listed in the table below.</li> </ul>					
<p><b>Fit</b></p>		<p><b>class 5</b></p>		<p><b>class 4</b></p>		
		<p><b>Tolerance class</b></p>				
<p>With shaft</p>	Inner ring rotation	js 5		js 4		
	Outer ring rotation	h 5		h 4		
<p>With housing</p>	Fixed side	JS 6		JS 5		
	Free side	H 6		H 5		
	Outer ring rotation	M 5		M 4		
<ul style="list-style-type: none"> <li>Refer to Table 11-3 on page A 115 for the recommended fits of high-precision matched pair bearings (class 5 and class 4), which are used with light preload (L) or middle preload (M).</li> </ul>						

Standard cages	<ul style="list-style-type: none"> <li>Pressed steel cage (supplementary code : //)</li> <li>Copper alloy machined cage (supplementary code : FY)</li> </ul>	<b>Application of standard cages</b>	
		<b>Bearing series</b>	<b>Pressed cage</b>
[Note] Machine tools are generally equipped with bearings that have a phenolic resin machined cage (FT). Bearings with a polyamide molded cage can also be used depending on the applications. Four-point contact ball bearings usually use a copper alloy machined cage.	79C	—	7900C – 7932C
	79CPA	—	7900CPA – 7932CPA
	70	—	7000 – 7040
	70B	—	7000B – 7040B
	70C	—	7000C – 7040C
	70CPA	—	7000CPA – 7034CPA
	72	7200 – 7220	7200 – 7240
	72B	7200B – 7220B	7200B – 7240B
	72C	7200C – 7220C	7200C – 7240C
	72CPA	—	7200CPA – 7230CPA
	73	7300 – 7320	7300 – 7340
	73B	7303B – 7320B	7303B – 7340B
	73C	7303C – 7320C	7303C – 7334C
	74	7405 – 7409	7404 – 7418
74B	7405B – 7409B	7404B – 7418B	
32	3200 – 3215	3216 – 3222	
33	3302 – 3313	3314 – 3322	
52	5203 – 5214	—	
53	5304 – 5315	—	

Allowable misalignment Single-row.....0.000 6 rad (2') : Matched pair, double-row.....misalignment not allowed

Equivalent radial load	Dynamic equivalent radial load $P_r = XF_r + YF_a$	Contact angle	$i f_0 F_a^*$	$C_{Or}$	$e$	Single-row and tandem arrangement				Back-to-back and face-to-face arrangement																																																												
						$F_a/F_r \leq e$		$F_a/F_r > e$		$F_a/F_r \leq e$		$F_a/F_r > e$																																																										
[Single-row and matched pair angular contact ball bearings]		15°	0.178	0.38	1	0	0.44	1.47	1.65	2.39	0.357	0.40	1.40	1.57	2.28																																																							
																0.714	0.43	1.30	1.46	2.11																																																		
																					1.07	0.46	1.23	1.38	2.00																																													
																										1.43	0.47	1.19	1.34	1.93																																								
																															2.14	0.50	1.12	1.26	1.82																																			
																																				3.57	0.55	1.02	1.14	1.66																														
																																									5.35	0.56	1.00	1.12	1.63																									
																																														7.14	0.56	1.00	1.12	1.63																				
																																																			—	0.80	1	0	0.39	0.76	1	0.78	0.63	1.24										
																																																													—	1.14	1	0	0.35	0.57	1	0.55	0.57	0.93

\* For  $i$ , use 2 for DB&DF and 1 for single&DT. Factor  $f_0$  is shown in the bearing dimension table.

Static equivalent radial load $P_{0r} = X_0 F_r + Y_0 F_a$	Contact angle	Single-row and tandem arrangement		Back-to-back and face-to-face arrangement	
		$X_0$	$Y_0$	$X_0$	$Y_0$
In reference to single-row and tandem arrangement bearings, when $P_{0r} < F_r$ , $P_{0r} = F_r$	15°	0.5	0.46	1	0.92
	30°	0.5	0.33	1	0.66
	40°	0.5	0.26	1	0.52

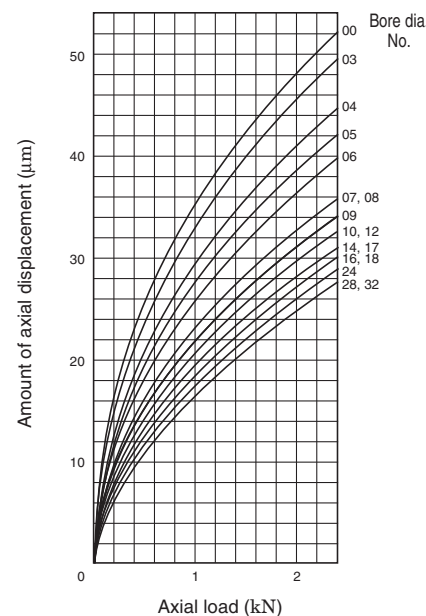
Equivalent radial load	[Double-row angular contact ball bearings]	Dynamic equivalent radial load $P_r = XF_r + YF_a$						
		Contact angle	$e$	$F_a/F_r \leq e$		$F_a/F_r > e$		(reference)
		24°	0.66	1	0.95	0.68	1.45	52, 53 series
		32°	0.86	1	0.73	0.62	1.17	32, 33 series
		Static equivalent radial load $P_{0r} = X_0 F_r + Y_0 F_a$						
		Contact angle	$X_0$	$Y_0$	(reference)			
		24°	1	0.78	52, 53 series			
		32°	1	0.63	32, 33 series			

[Note] In angular contact ball bearings, slippage occurs between the balls and raceways under too small a load, causing smearing to develop. Matched pair bearings may develop smearing when the ratio of the axial load to the radial load exceeds the value of  $e$  ( $F_a / F_r > e$ ), as listed in the specification table. Consult with JTEKT when these bearings are used under the above conditions.

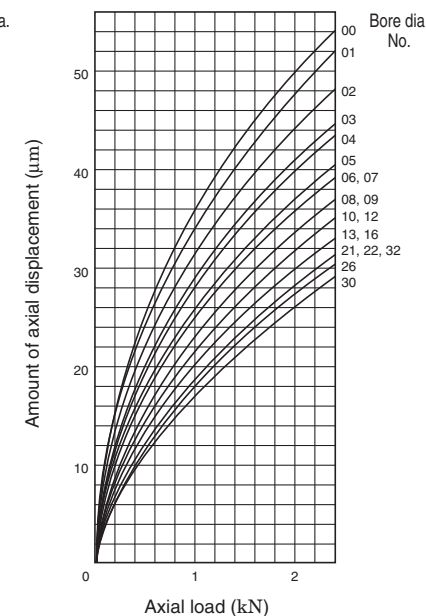
[Reference] Relationship between axial load and axial displacement

Diagrams (1) to (9) illustrate the relationship between axial load and axial displacement.

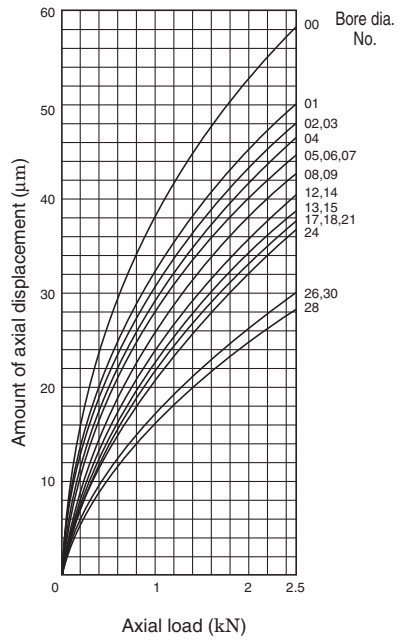
(1) 7900C (contact angle 15°)



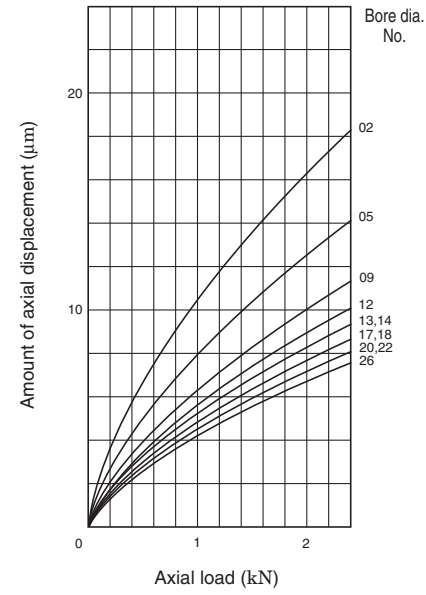
(2) 7000C (contact angle 15°)



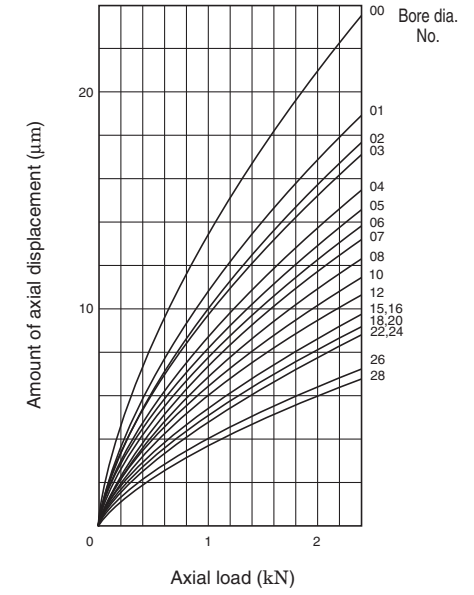
(3) 7200C (contact angle 15°)



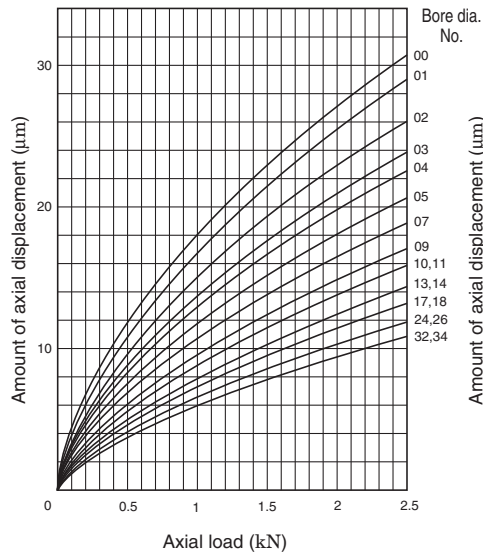
(6) 7000B (contact angle 40°)



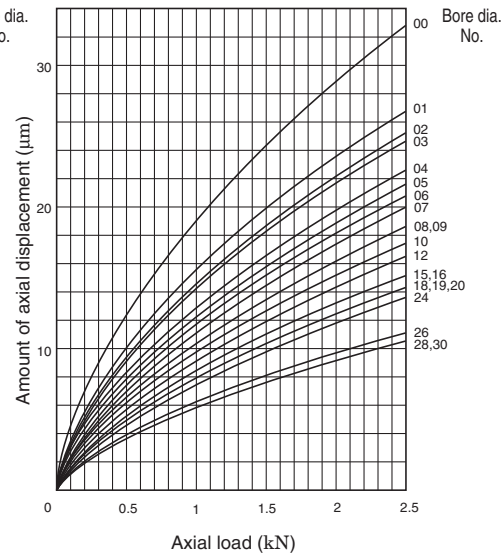
(7) 7200B (contact angle 40°)



(4) 7000 (contact angle 30°)

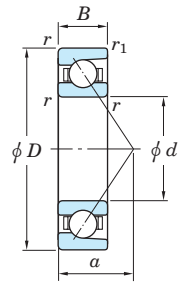


(5) 7200 (contact angle 30°)

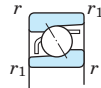


Single-row angular contact ball bearings

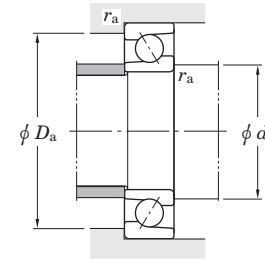
$d$  10 ~ (17) mm



With machined cage



With pressed cage



Boundary dimensions (mm)					Basic load ratings (kN)				Fatigue load limits (kN)		Factor	Limiting speeds <sup>1)</sup> (min <sup>-1</sup> )		Bearing No. <sup>2)</sup>	Load center (mm) $a$	Mounting dimensions (mm)			(Refer.) Mass (kg)
$d$	$D$	$B$	$r$ min.	$r_1$ min.	With machined cage		With pressed cage		$C_u$			Grease lub.	Oil lub.			$d_a$ min.	$D_a$ max.	$r_a$ max.	
					$C_r$	$C_{0r}$	$C_r$	$C_{0r}$	[With machined cage]	[With pressed cage]	$f_0$								
10	22	6	0.3	0.15	3.75	1.50	—	—	0.060	—	14.2	52 000	69 000	7900C	5.1	12.5	19.5	0.3	0.008
	26	8	0.3	0.15	6.25	2.35	—	—	0.120	—	—	34 000	42 000	7000	9.1	12.5	23.5	0.3	0.021
	26	8	0.3	0.15	5.80	2.15	—	—	0.110	—	—	25 000	33 000	7000B	11.6	12.5	23.5	0.3	0.021
	26	8	0.3	0.15	6.60	2.45	—	—	0.130	—	12.5	47 000	62 000	7000C	6.4	12.5	23.5	0.3	0.021
	30	9	0.6	0.3	5.85	2.20	6.75	2.75	0.110	0.140	—	29 000	37 000	7200	10.4	14.5	25.5	0.6	0.031
	30	9	0.6	0.3	5.35	2.00	6.20	2.50	0.100	0.130	—	22 000	29 000	7200B	13.1	14.5	25.5	0.6	0.031
	30	9	0.6	0.3	6.25	2.35	7.25	2.95	0.120	0.150	13.4	40 000	54 000	7200C	7.2	14.5	25.5	0.6	0.031
	35	11	0.6	0.3	10.6	3.75	11.6	4.30	0.300	0.340	—	27 000	33 000	7300	12.0	14.5	30.5	0.6	0.054
12	24	6	0.3	0.15	4.00	1.70	—	—	0.070	—	14.7	48 000	62 000	7901C	5.4	14.5	21.5	0.3	0.010
	28	8	0.3	0.15	6.75	2.75	—	—	0.140	—	—	29 000	37 000	7001	9.9	14.5	25.5	0.3	0.024
	28	8	0.3	0.15	6.20	2.50	—	—	0.130	—	—	22 000	29 000	7001B	12.6	14.5	25.5	0.3	0.024
	28	8	0.3	0.15	7.25	2.95	—	—	0.150	—	13.4	40 000	54 000	7001C	6.7	14.5	25.5	0.3	0.024
	32	10	0.6	0.3	9.30	3.65	10.0	4.05	0.280	0.310	—	27 000	34 000	7201	11.4	16.5	27.5	0.6	0.038
	32	10	0.6	0.3	8.65	3.40	9.30	3.75	0.240	0.270	—	20 000	27 000	7201B	14.2	16.5	27.5	0.6	0.038
	32	10	0.6	0.3	9.90	3.85	10.6	4.30	0.300	0.330	12.5	38 000	50 000	7201C	7.9	16.5	27.5	0.6	0.038
	37	12	1	0.6	12.8	4.60	14.0	5.25	0.360	0.410	—	24 000	31 000	7301	13.1	17.5	31.5	1	0.065
15	28	7	0.3	0.15	5.95	2.65	—	—	0.110	—	14.5	39 000	52 000	7902C	6.4	17.5	25.5	0.3	0.015
	32	9	0.3	0.15	7.65	3.45	—	—	0.180	—	—	26 000	32 000	7002	11.3	17.5	29.5	0.3	0.035
	32	9	0.3	0.15	6.95	3.15	—	—	0.160	—	—	19 000	25 000	7002B	14.6	17.5	29.5	0.3	0.035
	32	9	0.3	0.15	8.25	3.70	—	—	0.190	—	14.1	35 000	47 000	7002C	7.6	17.5	29.5	0.3	0.035
	35	11	0.6	0.3	10.1	4.25	10.1	4.25	0.300	0.300	—	24 000	29 000	7202	12.9	19.5	30.5	0.6	0.048
	35	11	0.6	0.3	9.30	3.95	9.30	3.95	0.260	0.260	—	18 000	24 000	7202B	16.2	19.5	30.5	0.6	0.048
	35	11	0.6	0.3	10.8	4.55	10.8	4.55	0.340	0.340	13.3	33 000	43 000	7202C	8.9	19.5	30.5	0.6	0.048
	42	13	1	0.6	15.7	6.45	16.8	7.20	0.490	0.550	—	20 000	25 000	7302	15.0	20.5	36.5	1	0.088
17	30	7	0.3	0.15	6.25	2.95	—	—	0.120	—	14.9	36 000	47 000	7903C	6.7	19.5	27.5	0.3	0.016
	35	10	0.3	0.15	8.40	4.15	—	—	0.210	—	—	23 000	28 000	7003	12.7	19.5	32.5	0.3	0.045

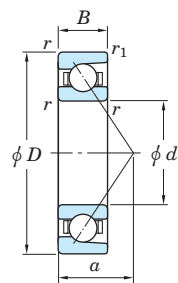
[Notes] 1) Limiting speeds shown above are applicable to machined cage bearings. Limiting speeds of pressed cage bearings should be kept to under 80% of this value. For bearings with 15° contact angle, this figure is applied to the high precision bearings ranked higher than class 5, used with machined cage or molded cage.

2) B, C or no indication after the bearing number indicates nominal contact angle of 40°, 15° and 30° respectively.

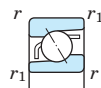
[Remark] Standard cage types used for the above bearings are described earlier in this section.

Single-row angular contact ball bearings

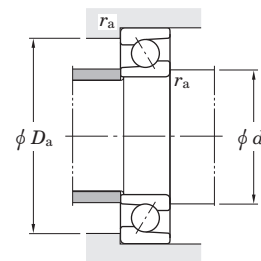
d (17) ~ (25) mm



With machined cage



With pressed cage



Boundary dimensions (mm)					Basic load ratings (kN)				Fatigue load limits (kN)		Factor	Limiting speeds <sup>1)</sup> (min <sup>-1</sup> )		Bearing No. <sup>2)</sup>	Load center (mm) a	Mounting dimensions (mm)			(Refer.) Mass (kg)
d	D	B	r min.	r1 min.	With machined cage		With pressed cage		Cu			Grease lub.	Oil lub.			da min.	Da max.	ra max.	
17	35	10	0.3	0.15	7.60	3.75	—	—	0.190	—	—	17 000	23 000	7003B	16.1	19.5	32.5	0.3	0.045
	35	10	0.3	0.15	9.15	4.45	—	—	0.230	—	14.6	31 000	41 000	7003C	8.6	19.5	32.5	0.3	0.045
	40	12	0.6	0.3	12.7	5.50	12.7	5.50	0.380	0.380	—	21 000	26 000	7203	14.4	21.5	35.5	0.6	0.070
	40	12	0.6	0.3	11.7	5.05	11.7	5.05	0.330	0.330	—	16 000	21 000	7203B	18.2	21.5	35.5	0.6	0.070
	40	12	0.6	0.3	13.6	5.90	13.6	5.90	0.440	0.440	13.4	29 000	38 000	7203C	9.9	21.5	35.5	0.6	0.070
	47	14	1	0.6	18.7	7.90	20.0	8.75	0.590	0.660	—	18 000	23 000	7303	16.5	22.5	41.5	1	0.120
	47	14	1	0.6	17.3	7.30	18.5	8.10	0.510	0.570	—	14 000	18 000	7303B	20.8	22.5	41.5	1	0.120
	47	14	1	0.6	19.8	8.40	19.8	8.40	0.650	0.650	12.6	25 000	33 000	7303C	11.4	22.5	41.5	1	0.120
20	37	9	0.3	0.15	9.10	4.55	—	—	0.240	—	14.9	30 000	39 000	7904C	8.3	22.5	34.5	0.3	0.035
	42	12	0.6	0.3	12.9	6.10	—	—	0.390	—	—	19 000	24 000	7004	15.1	24.5	37.5	0.6	0.079
	42	12	0.6	0.3	11.7	5.55	—	—	0.340	—	—	14 000	19 000	7004B	19.2	24.5	37.5	0.6	0.079
	42	12	0.6	0.3	13.9	6.60	—	—	0.450	—	14.1	26 000	35 000	7004C	10.2	24.5	37.5	0.6	0.079
	47	14	1	0.6	18.1	8.40	19.2	9.15	0.580	0.640	—	17 000	22 000	7204	17.0	25.5	41.5	1	0.112
	47	14	1	0.6	16.6	7.70	17.6	8.40	0.500	0.550	—	13 000	17 000	7204B	21.5	25.5	41.5	1	0.112
	47	14	1	0.6	19.4	9.00	20.6	9.80	0.670	0.730	13.4	24 000	32 000	7204C	11.6	25.5	41.5	1	0.112
	52	15	1.1	0.6	21.8	9.40	23.4	10.4	0.710	0.790	—	17 000	21 000	7304	17.9	27	45	1	0.150
	52	15	1.1	0.6	20.2	8.70	21.7	9.65	0.610	0.680	—	13 000	17 000	7304B	22.6	27	45	1	0.150
	52	15	1.1	0.6	23.1	9.95	24.8	11.1	0.780	0.860	12.6	23 000	31 000	7304C	12.3	27	45	1	0.150
	72	19	1.1	0.6	44.5	19.1	—	—	1.50	—	—	9 600	13 000	7404	23.1	27	65	1	0.395
	72	19	1.1	0.6	41.9	17.9	—	—	1.40	—	—	8 500	12 000	7404B	29.2	27	65	1	0.395
25	42	9	0.3	0.15	10.2	5.45	—	—	0.300	—	15.5	25 000	33 000	7905C	9.1	27.5	39.5	0.3	0.041
	47	12	0.6	0.3	14.1	7.40	—	—	0.450	—	—	17 000	21 000	7005	16.4	29.5	42.5	0.6	0.091
	47	12	0.6	0.3	12.8	6.70	—	—	0.390	—	—	12 000	17 000	7005B	21.1	29.5	42.5	0.6	0.091
	47	12	0.6	0.3	15.4	8.00	—	—	0.510	—	14.7	23 000	30 000	7005C	10.8	29.5	42.5	0.6	0.091
	52	15	1	0.6	19.2	9.50	20.2	10.3	0.620	0.670	—	15 000	19 000	7205	18.8	30.5	46.5	1	0.135
	52	15	1	0.6	17.5	8.70	18.4	9.40	0.530	0.580	—	12 000	15 000	7205B	23.9	30.5	46.5	1	0.135

[Notes] 1) Limiting speeds shown above are applicable to machined cage bearings. Limiting speeds of pressed cage bearings should be kept to under 80% of this value. For bearings with 15° contact angle, this figure is applied to the high precision bearings ranked higher than class 5, used with machined cage or molded cage.

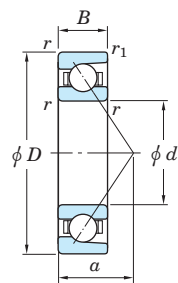
2) B, C or no indication after the bearing number indicates nominal contact angle of 40°, 15° and 30° respectively.

[Remark] Standard cage types used for the above bearings are described earlier in this section.

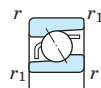


Single-row angular contact ball bearings

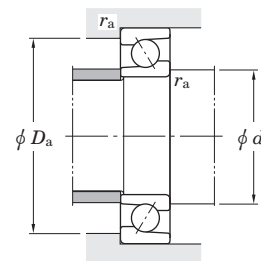
d (25) ~ (35) mm



With machined cage



With pressed cage



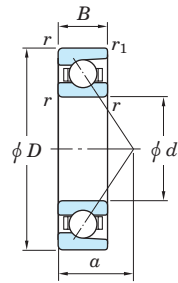
Boundary dimensions (mm)					Basic load ratings (kN)				Fatigue load limits (kN)		Factor	Limiting speeds <sup>1)</sup> (min <sup>-1</sup> )		Bearing No. <sup>2)</sup>	Load center (mm) a	Mounting dimensions (mm)			(Refer.) Mass (kg)
d	D	B	r min.	r <sub>1</sub> min.	With machined cage		With pressed cage		C <sub>u</sub>			Grease lub.	Oil lub.			d <sub>a</sub> min.	D <sub>a</sub> max.	r <sub>a</sub> max.	
					C <sub>r</sub>	C <sub>0r</sub>	C <sub>r</sub>	C <sub>0r</sub>	[With machined cage]	[With pressed cage]	f <sub>0</sub>								
25	52	15	1	0.6	20.7	10.2	21.9	11.1	0.710	0.770	14.0	21 000	28 000	7205C	12.7	30.5	46.5	1	0.135
	62	17	1.1	0.6	31.0	14.4	33.0	15.8	1.05	1.15	—	14 000	17 000	7305	21.1	32	55	1	0.243
	62	17	1.1	0.6	28.6	13.3	30.5	14.6	0.910	1.00	—	10 000	14 000	7305B	26.8	32	55	1	0.243
	62	17	1.1	0.6	33.0	15.3	35.1	16.8	1.20	1.30	12.8	19 000	25 000	7305C	14.3	32	55	1	0.243
	80	21	1.5	1	49.7	23.2	53.3	25.7	1.80	2.00	—	8 200	11 000	7405	26.4	33.5	71.5	1.5	0.527
	80	21	1.5	1	46.1	21.5	49.5	23.9	1.55	1.70	—	7 300	10 000	7405B	33.6	33.5	71.5	1.5	0.527
30	47	9	0.3	0.15	10.4	6.25	—	—	0.320	—	15.9	22 000	29 000	7906C	9.7	32.5	44.5	0.3	0.046
	55	13	1	0.6	18.2	10.1	—	—	0.610	—	—	14 000	18 000	7006	18.8	35.5	49.5	1	0.133
	55	13	1	0.6	16.4	9.20	—	—	0.530	—	—	11 000	14 000	7006B	24.3	35.5	49.5	1	0.133
	55	13	1	0.6	19.8	11.0	—	—	0.690	—	14.9	20 000	26 000	7006C	12.2	35.5	49.5	1	0.133
	62	16	1	0.6	26.7	13.7	28.1	14.8	0.890	0.970	—	13 000	16 000	7206	21.5	35.5	56.5	1	0.208
	62	16	1	0.6	24.3	12.5	25.6	13.6	0.770	0.840	—	9 600	13 000	7206B	27.6	35.5	56.5	1	0.208
	62	16	1	0.6	28.8	14.7	30.4	16.0	1.00	1.10	14.0	18 000	24 000	7206C	14.3	35.5	56.5	1	0.208
	72	19	1.1	0.6	37.6	18.9	39.9	20.6	1.30	1.45	—	12 000	14 000	7306	24.5	37	65	1	0.362
	72	19	1.1	0.6	34.5	17.4	36.6	19.0	1.15	1.25	—	8 700	12 000	7306B	31.3	37	65	1	0.362
	72	19	1.1	0.6	40.4	20.3	42.8	22.1	1.50	1.65	13.4	16 000	21 000	7306C	16.5	37	65	1	0.362
	90	23	1.5	1	59.5	28.4	63.9	31.6	2.20	2.45	—	7 300	9 700	7406	29.3	38.5	81.5	1.5	0.686
	90	23	1.5	1	55.2	26.4	59.3	29.3	1.90	2.10	—	6 500	8 900	7406B	37.3	38.5	81.5	1.5	0.686
35	55	10	0.6	0.3	15.7	9.70	—	—	0.550	—	15.7	19 000	25 000	7907C	11.0	39.5	50.5	0.6	0.074
	62	14	1	0.6	21.9	12.6	—	—	0.740	—	—	12 000	15 000	7007	21.2	40.5	56.5	1	0.170
	62	14	1	0.6	19.7	11.4	—	—	0.640	—	—	9 200	12 000	7007B	27.6	40.5	56.5	1	0.170
	62	14	1	0.6	23.9	13.7	—	—	0.840	—	15.0	17 000	22 000	7007C	13.5	40.5	56.5	1	0.170
	72	17	1.1	0.6	35.2	18.6	37.1	20.2	1.20	1.30	—	11 000	14 000	7207	24.2	42	65	1	0.295
	72	17	1.1	0.6	32.0	17.0	33.8	18.5	1.05	1.15	—	8 300	11 000	7207B	31.4	42	65	1	0.295
	72	17	1.1	0.6	38.0	20.1	40.1	21.7	1.40	1.50	14.0	15 000	20 000	7207C	15.8	42	65	1	0.295
	80	21	1.5	1	44.2	22.0	49.9	26.4	1.55	1.85	—	10 000	13 000	7307	27.4	43.5	71.5	1.5	0.475
	80	21	1.5	1	40.6	20.2	45.8	24.3	1.30	1.60	—	7 700	10 000	7307B	35.0	43.5	71.5	1.5	0.475

[Notes] 1) Limiting speeds shown above are applicable to machined cage bearings. Limiting speeds of pressed cage bearings should be kept to under 80% of this value. For bearings with 15° contact angle, this figure is applied to the high precision bearings ranked higher than class 5, used with machined cage or molded cage.

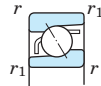
2) B, C or no indication after the bearing number indicates nominal contact angle of 40°, 15° and 30° respectively. [Remark] Standard cage types used for the above bearings are described earlier in this section.

Single-row angular contact ball bearings

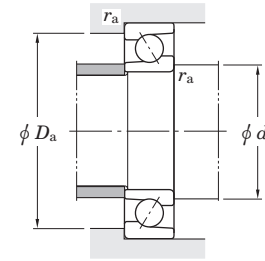
d (35) ~ 45 mm



With machined cage



With pressed cage



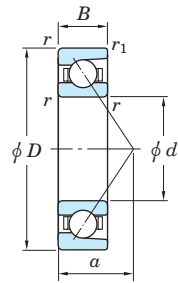
Boundary dimensions (mm)					Basic load ratings (kN)				Fatigue load limits (kN)		Factor	Limiting speeds <sup>1)</sup> (min <sup>-1</sup> )		Bearing No. <sup>2)</sup>	Load center (mm) a	Mounting dimensions (mm)			(Refer.) Mass (kg)
d	D	B	r min.	r1 min.	With machined cage		With pressed cage		Cu			Grease lub.	Oil lub.			da min.	Da max.	ra max.	
					Cr	C0r	Cr	C0r	[With machined cage]	[With pressed cage]	f0								
35	80	21	1.5	1	47.4	23.6	53.5	28.3	1.75	2.10	13.4	14 000	19 000	7307C	18.3	43.5	71.5	1.5	0.475
	100	25	1.5	1	75.6	37.0	81.1	41.1	2.85	3.20	—	6 500	8 600	7407	32.6	43.5	91.5	1.5	0.950
	100	25	1.5	1	70.2	34.3	75.3	38.1	2.45	2.75	—	5 700	7 900	7407B	41.7	43.5	91.5	1.5	0.950
40	62	12	0.6	0.3	19.7	12.4	—	—	0.710	—	15.7	17 000	22 000	7908C	12.8	44.5	57.5	0.6	0.107
	68	15	1	0.6	23.4	14.6	—	—	0.830	—	—	11 000	14 000	7008	23.2	45.5	62.5	1	0.210
	68	15	1	0.6	21.1	13.2	—	—	0.720	—	—	8 300	11 000	7008B	30.2	45.5	62.5	1	0.210
	68	15	1	0.6	25.7	15.9	—	—	0.940	—	15.4	15 000	20 000	7008C	14.8	45.5	62.5	1	0.210
	80	18	1.1	0.6	42.0	23.3	44.1	25.1	1.50	1.60	—	10 000	12 000	7208	26.3	47	73	1	0.382
	80	18	1.1	0.6	38.2	21.3	40.2	23.0	1.30	1.40	—	7 500	10 000	7208B	34.2	47	73	1	0.382
	80	18	1.1	0.6	45.4	25.2	47.7	27.1	1.70	1.85	14.2	14 000	18 000	7208C	17.0	47	73	1	0.382
	90	23	1.5	1	54.0	27.4	61.0	32.9	1.90	2.30	—	9 200	12 000	7308	30.3	48.5	81.5	1.5	0.657
	90	23	1.5	1	49.6	25.2	56.0	30.3	1.65	2.00	—	6 900	9 200	7308B	38.8	48.5	81.5	1.5	0.657
	90	23	1.5	1	57.9	29.4	65.4	35.3	2.20	2.65	13.4	13 000	17 000	7308C	20.2	48.5	81.5	1.5	0.657
	110	27	2	1	87.4	43.5	93.8	48.4	3.35	3.70	—	5 900	7 900	7408	35.5	50	100	2	1.23
	110	27	2	1	81.1	40.4	87.0	44.9	2.90	3.20	—	5 200	7 200	7408B	45.4	50	100	2	1.23
45	68	12	0.6	0.3	20.8	14.1	—	—	0.770	—	16.0	15 000	20 000	7909C	13.6	49.5	63.5	0.6	0.127
	75	16	1	0.6	27.8	17.7	—	—	1.00	—	—	10 000	12 000	7009	25.3	50.5	69.5	1	0.260
	75	16	1	0.6	25.0	16.0	—	—	0.870	—	—	7 500	10 000	7009B	33.2	50.5	69.5	1	0.260
	75	16	1	0.6	30.5	19.3	—	—	1.15	—	15.4	14 000	18 000	7009C	16.0	50.5	69.5	1	0.260
	85	19	1.1	0.6	47.2	26.6	49.6	28.6	1.70	1.85	—	9 400	12 000	7209	28.0	52	78	1	0.430
	85	19	1.1	0.6	42.9	24.3	45.1	26.1	1.50	1.60	—	7 000	9 400	7209B	36.4	52	78	1	0.430
	85	19	1.1	0.6	51.0	28.7	53.6	30.9	1.95	2.10	14.2	13 000	17 000	7209C	18.1	52	78	1	0.430
	100	25	1.5	1	68.9	37.1	73.1	40.4	2.55	2.80	—	8 200	10 000	7309	33.6	53.5	91.5	1.5	0.875
	100	25	1.5	1	63.2	34.1	67.0	37.2	2.20	2.40	—	6 200	8 200	7309B	43.1	53.5	91.5	1.5	0.875
	100	25	1.5	1	74.0	39.7	78.4	43.4	2.95	3.20	13.5	11 000	15 000	7309C	22.3	53.5	91.5	1.5	0.875
	120	29	2	1	106	53.8	114	59.8	4.20	4.65	—	5 400	7 100	7409	38.6	55	110	2	1.55
	120	29	2	1	98.7	50.0	106	55.5	3.60	4.00	—	4 800	6 600	7409B	49.5	55	110	2	1.55

[Notes] 1) Limiting speeds shown above are applicable to machined cage bearings. Limiting speeds of pressed cage bearings should be kept to under 80% of this value. For bearings with 15° contact angle, this figure is applied to the high precision bearings ranked higher than class 5, used with machined cage or molded cage.

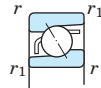
2) B, C or no indication after the bearing number indicates nominal contact angle of 40°, 15° and 30° respectively. [Remark] Standard cage types used for the above bearings are described earlier in this section.

Single-row angular contact ball bearings

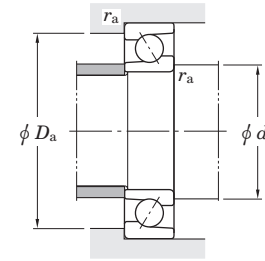
d 50 ~ (60) mm



With machined cage



With pressed cage



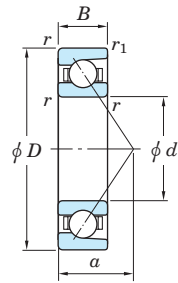
Boundary dimensions (mm)					Basic load ratings (kN)				Fatigue load limits (kN)		Factor	Limiting speeds <sup>1)</sup> (min <sup>-1</sup> )		Bearing No. <sup>2)</sup>	Load center (mm) a	Mounting dimensions (mm)			(Refer.) Mass (kg)
d	D	B	r min.	r <sub>1</sub> min.	With machined cage		With pressed cage		C <sub>u</sub>			Grease lub.	Oil lub.			d <sub>a</sub> min.	D <sub>a</sub> max.	r <sub>a</sub> max.	
					C <sub>r</sub>	C <sub>0r</sub>	C <sub>r</sub>	C <sub>0r</sub>	[With machined cage]	[With pressed cage]	f <sub>0</sub>								
50	72	12	0.6	0.3	21.8	15.7	—	—	0.840	—	16.2	14 000	18 000	7910C	14.2	54.5	67.5	0.6	0.128
	80	16	1	0.6	29.5	20.1	—	—	1.10	—	—	9 200	11 000	7010	26.9	55.5	74.5	1	0.290
	80	16	1	0.6	26.5	18.1	—	—	0.960	—	—	6 900	9 200	7010B	35.3	55.5	74.5	1	0.290
	80	16	1	0.6	32.5	21.9	—	—	1.25	—	15.7	13 000	17 000	7010C	16.8	55.5	74.5	1	0.290
	90	20	1.1	0.6	49.2	29.4	51.6	31.5	1.80	1.95	—	8 500	11 000	7210	30.4	57	83	1	0.485
	90	20	1.1	0.6	44.6	26.7	46.7	28.6	1.55	1.70	—	6 400	8 500	7210B	39.6	57	83	1	0.485
	90	20	1.1	0.6	53.5	31.8	56.0	34.1	2.05	2.20	14.6	12 000	16 000	7210C	19.4	57	83	1	0.485
	110	27	2	1	87.6	48.1	92.9	52.5	3.35	3.65	—	7 300	9 100	7310	37.2	60	100	2	1.14
	110	27	2	1	80.5	44.3	85.3	48.3	2.90	3.15	—	5 500	7 300	7310B	47.9	60	100	2	1.14
	110	27	2	1	93.9	51.6	99.5	56.2	3.85	4.20	13.4	10 000	13 000	7310C	24.5	60	100	2	1.14
55	130	31	2.1	1.1	122	65.3	—	—	4.90	—	—	4 900	6 600	7410	41.6	62	118	2	1.92
	130	31	2.1	1.1	113	60.4	—	—	4.20	—	—	4 400	6 000	7410B	53.5	62	118	2	1.92
	80	13	1	0.6	24.6	18.5	—	—	0.980	—	16.3	13 000	17 000	7911C	15.5	60.5	74.5	1	0.178
	90	18	1.1	0.6	38.9	26.3	—	—	1.50	—	—	8 300	10 000	7011	29.9	62	83	1	0.420
	90	18	1.1	0.6	34.9	23.7	—	—	1.30	—	—	6 200	8 300	7011B	39.4	62	83	1	0.420
	90	18	1.1	0.6	42.6	28.6	—	—	1.65	—	15.5	11 000	15 000	7011C	18.7	62	83	1	0.420
	100	21	1.5	1	60.9	37.1	63.7	39.8	2.30	2.45	—	7 600	9 500	7211	33.3	63.5	91.5	1.5	0.635
	100	21	1.5	1	55.1	33.8	57.7	36.2	2.00	2.15	—	5 700	7 600	7211B	43.6	63.5	91.5	1.5	0.635
	100	21	1.5	1	66.1	40.2	69.2	43.1	2.60	2.80	14.6	11 000	14 000	7211C	21.1	63.5	91.5	1.5	0.635
	120	29	2	1	101	56.5	107	61.7	3.95	4.30	—	6 700	8 400	7311	40.2	65	110	2	1.45
60	120	29	2	1	92.9	52.0	98.4	56.7	3.40	3.70	—	5 000	6 700	7311B	51.8	65	110	2	1.45
	120	29	2	1	108	60.6	115	66.1	4.50	4.90	13.4	9 300	12 000	7311C	26.4	65	110	2	1.45
	140	33	2.1	1.1	148	82.4	—	—	6.40	—	—	4 500	6 000	7411	45.0	67	128	2	2.36
	140	33	2.1	1.1	138	76.5	—	—	5.50	—	—	4 000	5 500	7411B	57.8	67	128	2	2.36
	85	13	1	0.6	29.0	21.8	—	—	1.15	—	16.3	12 000	16 000	7912C	16.3	65.5	79.5	1	0.187
	95	18	1.1	0.6	39.9	28.1	—	—	1.55	—	—	7 700	9 700	7012	31.4	67	88	1	0.450
	95	18	1.1	0.6	35.7	25.3	—	—	1.35	—	—	5 800	7 700	7012B	41.5	67	88	1	0.450

[Notes] 1) Limiting speeds shown above are applicable to machined cage bearings. Limiting speeds of pressed cage bearings should be kept to under 80% of this value. For bearings with 15° contact angle, this figure is applied to the high precision bearings ranked higher than class 5, used with machined cage or molded cage.

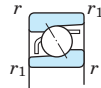
2) B, C or no indication after the bearing number indicates nominal contact angle of 40°, 15° and 30° respectively. [Remark] Standard cage types used for the above bearings are described earlier in this section.

Single-row angular contact ball bearings

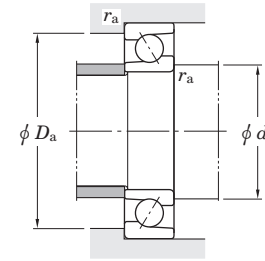
d (60) ~ (70) mm



With machined cage



With pressed cage



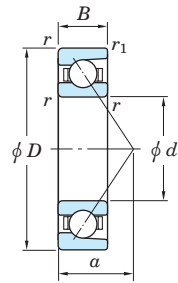
Boundary dimensions (mm)					Basic load ratings (kN)				Fatigue load limits (kN)		Factor	Limiting speeds <sup>1)</sup> (min <sup>-1</sup> )		Bearing No. <sup>2)</sup>	Load center (mm) a	Mounting dimensions (mm)			(Refer.) Mass (kg)
d	D	B	r min.	r1 min.	With machined cage		With pressed cage		Cu			Grease lub.	Oil lub.			da min.	Da max.	ra max.	
60	95	18	1.1	0.6	43.8	30.6	—	—	1.75	—	15.7	11 000	14 000	7012C	19.4	67	88	1	0.450
	110	22	1.5	1	73.7	45.7	77.1	49.0	2.85	3.05	—	6 900	8 600	7212	36.1	68.5	101.5	1.5	0.820
	110	22	1.5	1	66.8	41.6	69.9	44.6	2.45	2.60	—	5 100	6 900	7212B	47.5	68.5	101.5	1.5	0.820
	110	22	1.5	1	80.0	49.5	83.8	53.0	3.20	3.45	14.5	9 500	13 000	7212C	22.7	68.5	101.5	1.5	0.820
	130	31	2.1	1.1	116	65.6	123	71.6	4.55	5.00	—	6 200	7 700	7312	43.2	72	118	2	1.81
	130	31	2.1	1.1	106	60.3	113	65.8	3.95	4.30	—	4 600	6 200	7312B	55.8	72	118	2	1.81
	130	31	2.1	1.1	124	70.3	131	76.7	5.25	5.70	13.4	8 600	11 000	7312C	28.4	72	118	2	1.81
	150	35	2.1	1.1	161	93.6	—	—	6.85	—	—	4 100	5 500	7412	48.5	72	138	2	2.85
150	35	2.1	1.1	149	86.7	—	—	5.90	—	—	3 700	5 100	7412B	62.6	72	138	2	2.85	
65	90	13	1	0.6	25.9	21.2	—	—	1.10	—	16.5	11 000	15 000	7913C	16.9	70.5	84.5	1	0.205
	100	18	1.1	0.6	42.1	31.4	—	—	1.70	—	—	7 200	9 000	7013	33.0	72	93	1	0.470
	100	18	1.1	0.6	37.7	28.3	—	—	1.45	—	—	5 400	7 200	7013B	43.8	72	93	1	0.470
	100	18	1.1	0.6	46.3	34.3	—	—	1.90	—	15.9	10 000	13 000	7013C	20.1	72	93	1	0.470
	120	23	1.5	1	84.1	54.2	87.8	57.8	3.35	3.55	—	6 400	8 000	7213	38.2	73.5	111.5	1.5	1.02
	120	23	1.5	1	76.2	49.3	79.5	52.6	2.90	3.10	—	4 800	6 400	7213B	50.3	73.5	111.5	1.5	1.02
	120	23	1.5	1	91.4	58.7	95.4	62.6	3.80	4.05	14.6	8 900	12 000	7213C	23.9	73.5	111.5	1.5	1.02
	140	33	2.1	1.1	131	75.3	139	82.2	5.15	5.65	—	5 800	7 200	7313	46.3	77	128	2	2.22
	140	33	2.1	1.1	120	69.3	127	75.6	4.45	4.85	—	4 300	5 800	7313B	59.7	77	128	2	2.22
	140	33	2.1	1.1	140	80.7	149	88.1	5.90	6.45	13.4	8 000	11 000	7313C	30.3	77	128	2	2.22
	160	37	2.1	1.1	174	104	—	—	7.40	—	—	3 900	5 200	7413	51.4	77	148	2	3.41
	160	37	2.1	1.1	161	96.8	—	—	6.35	—	—	3 500	4 800	7413B	66.3	77	148	2	3.41
70	100	16	1	0.6	36.2	29.0	—	—	1.55	—	16.4	10 000	12 000	7914C	19.4	75.5	94.5	1	0.332
	110	20	1.1	0.6	53.3	39.4	—	—	2.15	—	—	6 600	8 300	7014	36.0	77	103	1	0.660
	110	20	1.1	0.6	47.8	35.5	—	—	1.90	—	—	5 000	6 600	7014B	47.8	77	103	1	0.660
	110	20	1.1	0.6	58.6	43.0	—	—	2.45	—	15.7	9 200	12 000	7014C	22.1	77	103	1	0.660
	125	24	1.5	1	87.3	55.6	95.4	63.5	3.40	3.90	—	6 100	7 600	7214	40.2	78.5	116.5	1.5	1.12
	125	24	1.5	1	79.0	50.6	86.4	57.8	2.95	3.40	—	4 600	6 100	7214B	52.9	78.5	116.5	1.5	1.12

[Notes] 1) Limiting speeds shown above are applicable to machined cage bearings. Limiting speeds of pressed cage bearings should be kept to under 80% of this value. For bearings with 15° contact angle, this figure is applied to the high precision bearings ranked higher than class 5, used with machined cage or molded cage.

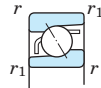
2) B, C or no indication after the bearing number indicates nominal contact angle of 40°, 15° and 30° respectively. [Remark] Standard cage types used for the above bearings are described earlier in this section.

Single-row angular contact ball bearings

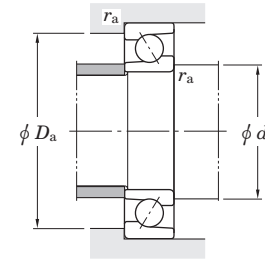
d (70) ~ (80) mm



With machined cage



With pressed cage



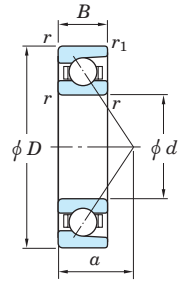
Boundary dimensions (mm)					Basic load ratings (kN)				Fatigue load limits (kN)		Factor	Limiting speeds <sup>1)</sup> (min <sup>-1</sup> )		Bearing No. <sup>2)</sup>	Load center (mm) a	Mounting dimensions (mm)			(Refer.) Mass (kg)
d	D	B	r min.	r <sub>1</sub> min.	With machined cage		With pressed cage		C <sub>u</sub>			Grease lub.	Oil lub.			d <sub>a</sub> min.	D <sub>a</sub> max.	r <sub>a</sub> max.	
70	125	24	1.5	1	94.9	60.2	104	68.8	3.90	4.45	14.6	8 400	11 000	7214C	25.1	78.5	116.5	1.5	1.12
	150	35	2.1	1.1	147	85.8	156	93.6	5.70	6.20	—	5 400	6 700	7314	49.3	82	138	2	2.70
	150	35	2.1	1.1	135	78.9	143	86.0	4.90	5.35	—	4 000	5 400	7314B	63.7	82	138	2	2.70
	150	35	2.1	1.1	158	91.9	167	100	6.50	7.10	13.4	7 500	9 900	7314C	32.2	82	138	2	2.70
	180	42	3	1.1	187	115	—	—	5.30	—	—	3 500	4 600	7414	57.6	84	166	2.5	4.99
	180	42	3	1.1	185	119	—	—	5.45	—	—	3 100	4 300	7414B	74.2	84	166	2.5	4.99
75	105	16	1	0.6	36.7	30.5	—	—	1.60	—	16.5	9 300	12 000	7915C	20.1	80.5	99.5	1	0.350
	115	20	1.1	0.6	54.6	41.7	—	—	2.25	—	—	6 300	7 800	7015	37.4	82	108	1	0.690
	115	20	1.1	0.6	48.8	37.6	—	—	1.95	—	—	4 700	6 300	7015B	49.9	82	108	1	0.690
	115	20	1.1	0.6	60.1	45.6	—	—	2.55	—	15.9	8 700	11 000	7015C	22.7	82	108	1	0.690
	130	25	1.5	1	99.0	65.2	103	69.5	3.95	4.20	—	5 800	7 200	7215	42.1	83.5	121.5	1.5	1.23
	130	25	1.5	1	89.6	59.3	93.6	63.3	3.40	3.65	—	4 300	5 800	7215B	55.5	83.5	121.5	1.5	1.23
	130	25	1.5	1	108	70.6	112	75.3	4.50	4.80	14.6	8 000	11 000	7215C	26.2	83.5	121.5	1.5	1.23
	160	37	2.1	1.1	160	97.0	170	106	6.20	6.75	—	5 000	6 300	7315	52.4	87	148	2	3.15
	160	37	2.1	1.1	147	89.2	156	97.3	5.35	5.85	—	3 800	5 000	7315B	67.8	87	148	2	3.15
	160	37	2.1	1.1	172	104	182	113	7.10	7.75	13.4	7 000	9 200	7315C	34.2	87	148	2	3.15
	190	45	3	1.1	214	141	—	—	6.30	—	—	3 300	4 400	7415	61.3	89	176	2.5	5.90
	190	45	3	1.1	198	131	—	—	5.80	—	—	2 900	4 000	7415B	78.9	89	176	2.5	5.90
80	110	16	1	0.6	37.3	31.6	—	—	1.65	—	16.5	8 800	11 000	7916C	20.7	85.5	104.5	1	0.368
	125	22	1.1	0.6	66.7	50.6	—	—	2.75	—	—	5 800	7 200	7016	40.6	87	118	1	0.930
	125	22	1.1	0.6	59.8	45.7	—	—	2.40	—	—	4 300	5 800	7016B	54.0	87	118	1	0.930
	125	22	1.1	0.6	73.3	55.3	—	—	3.10	—	15.7	8 000	11 000	7016C	24.7	87	118	1	0.930
	140	26	2	1	107	71.5	111	76.2	4.10	4.40	—	5 400	6 700	7216	44.8	90	130	2	1.50
	140	26	2	1	96.4	65.0	101	69.3	3.55	3.80	—	4 000	5 400	7216B	59.2	90	130	2	1.50
	140	26	2	1	116	77.5	121	82.7	4.70	5.00	14.7	7 500	9 900	7216C	27.7	90	130	2	1.50
	170	39	2.1	1.1	174	109	184	119	6.75	7.35	—	4 700	5 900	7316	55.6	92	158	2	3.85
	170	39	2.1	1.1	159	100	169	109	5.80	6.35	—	3 500	4 700	7316B	71.9	92	158	2	3.85

[Notes] 1) Limiting speeds shown above are applicable to machined cage bearings. Limiting speeds of pressed cage bearings should be kept to under 80% of this value. For bearings with 15° contact angle, this figure is applied to the high precision bearings ranked higher than class 5, used with machined cage or molded cage.

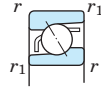
2) B, C or no indication after the bearing number indicates nominal contact angle of 40°, 15° and 30° respectively. [Remark] Standard cage types used for the above bearings are described earlier in this section.

Single-row angular contact ball bearings

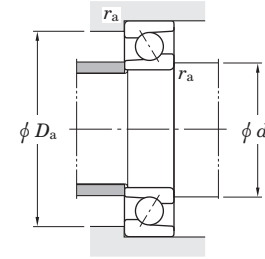
$d$  (80) ~ 90 mm



With machined cage



With pressed cage



Boundary dimensions (mm)					Basic load ratings (kN)				Fatigue load limits (kN)		Factor	Limiting speeds <sup>1)</sup> (min <sup>-1</sup> )		Bearing No. <sup>2)</sup>	Load center (mm) $a$	Mounting dimensions (mm)			(Refer.) Mass (kg)
$d$	$D$	$B$	$r$ min.	$r_1$ min.	With machined cage		With pressed cage		$C_u$			Grease lub.	Oil lub.			$d_a$ min.	$D_a$ max.	$r_a$ max.	
					$C_r$	$C_{0r}$	$C_r$	$C_{0r}$	[With machined cage]	[With pressed cage]	$f_0$								
80	170	39	2.1	1.1	186	117	197	127	7.70	8.40	13.5	6 500	8 600	7316C	36.2	92	158	2	3.85
	200	48	3	1.1	241	166	—	—	7.20	—	—	3 100	4 100	7416	65.0	94	186	2.5	6.00
	200	48	3	1.1	223	154	—	—	6.65	—	—	2 700	3 800	7416B	83.6	94	186	2.5	6.00
85	120	18	1.1	0.6	48.6	40.6	—	—	2.10	—	16.5	8 100	11 000	7917C	22.7	92	113	1	0.523
	130	22	1.1	0.6	68.2	53.7	—	—	2.75	—	—	5 500	6 800	7017	42.3	92	123	1	0.970
	130	22	1.1	0.6	61.0	48.4	—	—	2.40	—	—	4 100	5 500	7017B	56.5	92	123	1	0.970
	130	22	1.1	0.6	75.1	58.7	—	—	3.15	—	15.9	7 600	10 000	7017C	25.5	92	123	1	0.970
	150	28	2	1	123	83.6	129	89.2	4.70	5.00	—	5 000	6 300	7217	47.9	95	140	2	1.87
	150	28	2	1	111	76.0	116	81.1	4.05	4.35	—	3 800	5 000	7217B	63.3	95	140	2	1.87
	150	28	2	1	134	90.6	140	96.6	5.35	5.70	14.7	7 000	9 200	7217C	29.7	95	140	2	1.87
	180	41	3	1.1	187	122	198	133	7.30	7.95	—	4 400	5 500	7317	58.8	99	166	2.5	4.53
	180	41	3	1.1	172	112	182	122	6.30	6.85	—	3 300	4 400	7317B	76.1	99	166	2.5	4.53
	180	41	3	1.1	201	130	213	142	8.35	9.10	13.5	6 100	8 100	7317C	38.3	99	166	2.5	4.53
	210	52	4	1.5	255	180	—	—	7.65	—	—	3 000	3 900	7417	68.7	103	192	3	8.54
210	52	4	1.5	236	167	—	—	7.10	—	—	2 600	3 600	7417B	88.1	103	192	3	8.54	
90	125	18	1.1	0.6	49.5	42.6	—	—	2.15	—	16.6	7 800	10 000	7918C	23.4	97	118	1	0.551
	140	24	1.5	1	81.5	63.3	—	—	3.25	—	—	5 100	6 400	7018	45.2	98.5	131.5	1.5	1.26
	140	24	1.5	1	73.0	57.1	—	—	2.80	—	—	3 900	5 100	7018B	60.2	98.5	131.5	1.5	1.26
	140	24	1.5	1	89.6	69.1	—	—	3.65	—	15.7	7 100	9 400	7018C	27.4	98.5	131.5	1.5	1.26
	160	30	2	1	141	96.7	147	103	5.30	5.65	—	4 700	5 900	7218	51.1	100	150	2	2.30
	160	30	2	1	128	88.0	133	93.8	4.60	4.90	—	3 500	4 700	7218B	67.4	100	150	2	2.30
	160	30	2	1	153	105	160	112	6.00	6.40	14.6	6 500	8 600	7218C	31.7	100	150	2	2.30
	190	43	3	1.1	201	135	213	147	5.90	6.40	—	4 200	5 200	7318	61.9	104	176	2.5	5.30
	190	43	3	1.1	184	124	195	135	5.40	5.90	—	3 100	4 200	7318B	80.2	104	176	2.5	5.30
	190	43	3	1.1	216	145	229	158	6.30	6.90	13.5	5 800	7 700	7318C	40.3	104	176	2.5	5.30
	225	54	4	1.5	270	196	—	—	8.10	—	—	2 800	3 700	7418	72.5	108	207	3	11.4
	225	54	4	1.5	250	182	—	—	7.50	—	—	2 500	3 400	7418B	93.1	108	207	3	11.4

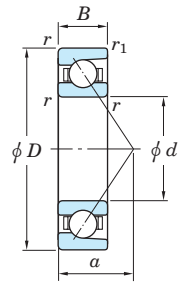
[Notes] 1) Limiting speeds shown above are applicable to machined cage bearings. Limiting speeds of pressed cage bearings should be kept to under 80% of this value. For bearings with 15° contact angle, this figure is applied to the high precision bearings ranked higher than class 5, used with machined cage or molded cage.

2) B, C or no indication after the bearing number indicates nominal contact angle of 40°, 15° and 30° respectively.

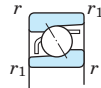
[Remark] Standard cage types used for the above bearings are described earlier in this section.

Single-row angular contact ball bearings

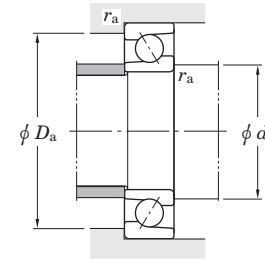
d 95 ~ (105) mm



With machined cage



With pressed cage



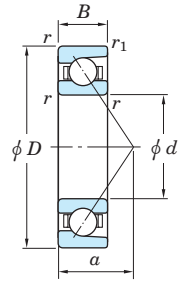
Boundary dimensions (mm)					Basic load ratings (kN)				Fatigue load limits (kN)		Factor	Limiting speeds <sup>1)</sup> (min <sup>-1</sup> )		Bearing No. <sup>2)</sup>	Load center (mm) a	Mounting dimensions (mm)			(Refer.) Mass (kg)
d	D	B	r min.	r1 min.	With machined cage		With pressed cage		Cu			Grease lub.	Oil lub.			da min.	Da max.	ra max.	
					Cr	C0r	Cr	C0r	[With machined cage]	[With pressed cage]	f0								
95	130	18	1.1	0.6	50.3	44.1	—	—	2.15	—	16.5	7 400	9 800	7919C	24.1	102	123	1	0.574
	145	24	1.5	1	83.3	67.1	—	—	3.25	—	—	4 800	6 000	7019	47.2	103.5	136.5	1.5	1.32
	145	24	1.5	1	74.5	60.5	—	—	2.85	—	—	3 600	4 800	7019B	63.2	103.5	136.5	1.5	1.32
	145	24	1.5	1	91.7	73.4	—	—	3.70	—	15.9	6 700	8 900	7019C	28.3	103.5	136.5	1.5	1.32
	170	32	2.1	1.1	153	103	160	111	5.50	5.90	—	4 400	5 500	7219	54.3	107	158	2	2.78
	170	32	2.1	1.1	138	94.0	145	101	4.80	5.10	—	3 300	4 400	7219B	71.6	107	158	2	2.78
	170	32	2.1	1.1	166	112	174	120	6.30	6.75	14.6	6 100	8 100	7219C	33.8	107	158	2	2.78
	200	45	3	1.1	215	149	228	162	6.35	6.90	—	4 000	4 900	7319	65.1	109	186	2.5	6.12
	200	45	3	1.1	197	137	209	149	5.80	6.35	—	3 000	4 000	7319B	84.4	109	186	2.5	6.12
200	45	3	1.1	231	160	245	174	6.80	7.40	13.5	5 500	7 300	7319C	42.3	109	186	2.5	6.12	
100	140	20	1.1	0.6	69.4	58.5	—	—	2.85	—	16.3	7 000	9 200	7920C	26.1	107	133	1	0.773
	150	24	1.5	1	85.5	70.6	—	—	3.35	—	—	4 700	5 900	7020	48.1	108.5	141.5	1.5	1.37
	150	24	1.5	1	76.5	63.6	—	—	2.95	—	—	3 500	4 700	7020B	64.4	108.5	141.5	1.5	1.37
	150	24	1.5	1	94.2	77.2	—	—	3.80	—	16.0	6 500	8 600	7020C	28.7	108.5	141.5	1.5	1.37
	180	34	2.1	1.1	171	117	180	126	6.10	6.50	—	4 100	5 200	7220	57.7	112	168	2	3.32
	180	34	2.1	1.1	155	107	163	115	5.25	5.65	—	3 100	4 200	7220B	76.2	112	168	2	3.32
	180	34	2.1	1.1	186	127	195	136	6.95	7.40	14.6	5 700	7 600	7220C	35.9	112	168	2	3.32
	215	47	3	1.1	229	161	259	194	6.60	7.95	—	3 600	4 600	7320	69.4	114	201	2.5	7.53
	215	47	3	1.1	210	148	238	178	6.10	7.30	—	2 700	3 600	7320B	90.2	114	201	2.5	7.53
215	47	3	1.1	246	173	278	208	7.10	8.50	13.4	5 000	6 700	7320C	44.8	114	201	2.5	7.53	
105	145	20	1.1	0.6	70.8	61.5	—	—	2.90	—	16.4	6 700	8 800	7921C	26.7	112	138	1	0.810
	160	26	2	1	99.7	81.9	—	—	3.80	—	—	4 400	5 500	7021	51.8	115	150	2	1.73
	160	26	2	1	89.2	73.8	—	—	3.30	—	—	3 300	4 400	7021B	68.6	115	150	2	1.73
	160	26	2	1	110	89.6	—	—	4.30	—	15.9	6 000	8 000	7021C	31.0	115	150	2	1.73
	190	36	2.1	1.1	187	132	—	—	6.70	—	—	3 900	4 900	7221	61.0	117	178	2	3.95
	190	36	2.1	1.1	169	121	—	—	5.80	—	—	2 900	3 900	7221B	80.5	117	178	2	3.95

[Notes] 1) Limiting speeds shown above are applicable to machined cage bearings. Limiting speeds of pressed cage bearings should be kept to under 80% of this value. For bearings with 15° contact angle, this figure is applied to the high precision bearings ranked higher than class 5, used with machined cage or molded cage.

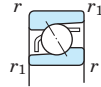
2) B, C or no indication after the bearing number indicates nominal contact angle of 40°, 15° and 30° respectively. [Remark] Standard cage types used for the above bearings are described earlier in this section.

Single-row angular contact ball bearings

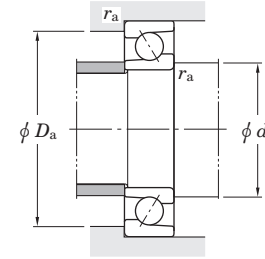
$d$  (105) ~ (130) mm



With machined cage



With pressed cage



Boundary dimensions (mm)					Basic load ratings (kN)				Fatigue load limits (kN)		Factor	Limiting speeds <sup>1)</sup> (min <sup>-1</sup> )		Bearing No. <sup>2)</sup>	Load center (mm) $a$	Mounting dimensions (mm)			(Refer.) Mass (kg)
$d$	$D$	$B$	$r$ min.	$r_1$ min.	With machined cage		With pressed cage		$C_u$			Grease lub.	Oil lub.			$d_a$ min.	$D_a$ max.	$r_a$ max.	
					$C_r$	$C_{0r}$	$C_r$	$C_{0r}$	[With machined cage]	[With pressed cage]	$f_0$								
<b>105</b>	190	36	2.1	1.1	203	143	—	—	7.60	—	14.6	5 400	7 200	<b>7221C</b>	38.0	117	178	2	3.95
	225	49	3	1.1	260	193	—	—	7.75	—	—	3 500	4 400	<b>7321</b>	72.1	119	211	2.5	8.62
	225	49	3	1.1	238	177	—	—	7.15	—	—	2 600	3 500	<b>7321B</b>	93.7	119	211	2.5	8.62
	225	49	3	1.1	278	207	—	—	8.30	—	13.4	4 800	6 400	<b>7321C</b>	46.6	119	211	2.5	8.62
<b>110</b>	150	20	1.1	0.6	72.2	64.4	—	—	2.95	—	16.5	6 400	8 500	<b>7922C</b>	27.4	117	143	1	0.840
	170	28	2	1	115	92.8	—	—	4.30	—	—	4 200	5 200	<b>7022</b>	54.4	120	160	2	2.14
	170	28	2	1	103	83.7	—	—	3.75	—	—	3 100	4 200	<b>7022B</b>	72.7	120	160	2	2.14
	170	28	2	1	126	101	—	—	4.85	—	15.7	5 800	7 700	<b>7022C</b>	32.8	120	160	2	2.14
	200	38	2.1	1.1	202	148	—	—	7.30	—	—	3 700	4 600	<b>7222</b>	64.3	122	188	2	4.65
	200	38	2.1	1.1	183	135	—	—	6.35	—	—	2 800	3 700	<b>7222B</b>	84.9	122	188	2	4.65
	200	38	2.1	1.1	220	160	—	—	8.35	—	14.5	5 100	6 800	<b>7222C</b>	40.0	122	188	2	4.65
	240	50	3	1.1	290	226	—	—	8.75	—	—	3 200	4 000	<b>7322</b>	76.4	124	226	2.5	10.1
	240	50	3	1.1	266	208	—	—	8.05	—	—	2 400	3 200	<b>7322B</b>	99.6	124	226	2.5	10.1
	240	50	3	1.1	311	242	—	—	9.40	—	13.4	4 500	5 900	<b>7322C</b>	48.8	124	226	2.5	10.1
<b>120</b>	165	22	1.1	0.6	89.7	81.2	—	—	3.55	—	16.5	5 900	7 800	<b>7924C</b>	30.1	127	158	1	1.15
	180	28	2	1	121	103	—	—	4.50	—	—	3 900	4 900	<b>7024</b>	57.3	130	170	2	2.27
	180	28	2	1	108	93.0	—	—	3.95	—	—	2 900	3 900	<b>7024B</b>	76.9	130	170	2	2.27
	180	28	2	1	133	113	—	—	5.10	—	16.0	5 400	7 100	<b>7024C</b>	34.1	130	170	2	2.27
	215	40	2.1	1.1	218	166	—	—	7.85	—	—	3 400	4 300	<b>7224</b>	68.5	132	203	2	5.49
	215	40	2.1	1.1	197	151	—	—	6.80	—	—	2 600	3 400	<b>7224B</b>	90.3	132	203	2	5.49
	215	40	2.1	1.1	237	180	—	—	8.95	—	14.6	4 800	6 300	<b>7224C</b>	42.5	132	203	2	5.49
	260	55	3	1.1	308	252	—	—	9.45	—	—	3 000	3 700	<b>7324</b>	82.3	134	246	2.5	12.6
	260	55	3	1.1	282	231	—	—	8.65	—	—	2 200	3 000	<b>7324B</b>	107.2	134	246	2.5	12.6
	260	55	3	1.1	331	271	—	—	10.2	—	13.7	4 100	5 500	<b>7324C</b>	53.0	134	246	2.5	12.6
<b>130</b>	180	24	1.5	1	109	99.9	—	—	4.20	—	16.4	5 400	7 100	<b>7926C</b>	32.8	138.5	171.5	1.5	1.50
	200	33	2	1	147	125	—	—	5.25	—	—	3 500	4 400	<b>7026</b>	64.1	140	190	2	3.43

[Notes] 1) Limiting speeds shown above are applicable to machined cage bearings. Limiting speeds of pressed cage bearings should be kept to under 80% of this value. For bearings with 15° contact angle, this figure is applied to the high precision bearings ranked higher than class 5, used with machined cage or molded cage.

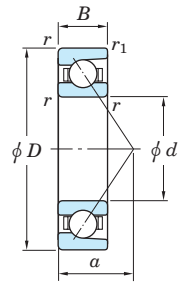
2) B, C or no indication after the bearing number indicates nominal contact angle of 40°, 15° and 30° respectively.

[Remark] Standard cage types used for the above bearings are described earlier in this section.

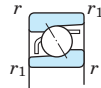


Single-row angular contact ball bearings

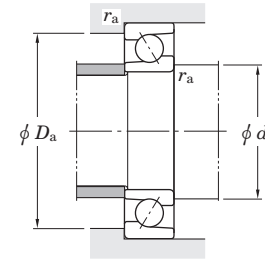
$d$  (130) ~ (150) mm



With machined cage



With pressed cage



Boundary dimensions (mm)					Basic load ratings (kN)				Fatigue load limits (kN)		Factor	Limiting speeds <sup>1)</sup> (min <sup>-1</sup> )		Bearing No. <sup>2)</sup>	Load center (mm) $a$	Mounting dimensions (mm)			(Refer.) Mass (kg)
$d$	$D$	$B$	$r$ min.	$r_1$ min.	With machined cage		With pressed cage		$C_u$			Grease lub.	Oil lub.			$d_a$ min.	$D_a$ max.	$r_a$ max.	
130	200	33	2	1	131	113	—	—	4.60	—	—	2 600	3 500	7026B	85.7	140	190	2	3.43
	200	33	2	1	161	137	—	—	5.95	—	15.9	4 800	6 400	7026C	38.6	140	190	2	3.43
	230	40	3	1.1	245	198	—	—	7.60	—	—	3 200	4 000	7226	72.0	144	216	2.5	6.21
	230	40	3	1.1	222	180	—	—	6.95	—	—	2 400	3 200	7226B	95.5	144	216	2.5	6.21
	230	40	3	1.1	266	214	—	—	8.25	—	14.7	4 400	5 800	7226C	44.1	144	216	2.5	6.21
	280	58	4	1.5	376	329	—	—	11.8	—	—	2 700	3 400	7326	88.8	148	262	3	15.4
	280	58	4	1.5	312	268	—	—	9.70	—	—	2 100	2 700	7326B	115.0	148	262	3	15.4
	280	58	4	1.5	368	314	—	—	11.3	—	13.7	3 800	5 000	7326C	56.5	148	262	3	15.4
140	190	24	1.5	1	110	105	—	—	4.20	—	16.6	5 100	6 700	7928C	34.1	148.5	181.5	1.5	1.59
	210	33	2	1	150	133	—	—	5.30	—	—	3 300	4 100	7028	67.0	150	200	2	3.64
	210	33	2	1	134	119	—	—	4.65	—	—	2 500	3 300	7028B	89.9	150	200	2	3.64
	210	33	2	1	165	145	—	—	6.00	—	16.0	4 500	6 000	7028C	39.9	150	200	2	3.64
	250	42	3	1.1	273	234	—	—	8.65	—	—	2 900	3 600	7228	77.3	154	236	2.5	7.76
	250	42	3	1.1	247	213	—	—	7.85	—	—	2 200	2 900	7228B	102.8	154	236	2.5	7.76
	250	42	3	1.1	297	254	—	—	9.40	—	14.8	4 000	5 300	7228C	47.1	154	236	2.5	7.76
	300	62	4	1.5	411	374	—	—	13.0	—	—	2 500	3 200	7328	94.5	158	282	3	18.8
	300	62	4	1.5	378	344	—	—	12.0	—	—	1 900	2 500	7328B	123.3	158	282	3	18.8
	300	62	4	1.5	441	401	—	—	14.0	—	13.4	3 500	4 600	7328C	60.5	158	282	3	18.8
150	210	28	2	1	148	132	—	—	5.45	—	16.3	4 700	6 200	7930C	38.1	160	200	2	2.47
	225	35	2.1	1.1	171	154	—	—	5.95	—	—	3 000	3 800	7030	72.1	162	213	2	4.43
	225	35	2.1	1.1	153	138	—	—	5.20	—	—	2 300	3 000	7030B	96.2	162	213	2	4.43
	225	35	2.1	1.1	188	169	—	—	6.70	—	16.1	4 200	5 500	7030C	42.8	162	213	2	4.43
	270	45	3	1.1	310	280	—	—	9.95	—	—	2 700	3 300	7230	83.1	164	256	2.5	9.75
	270	45	3	1.1	281	254	—	—	9.05	—	—	2 000	2 700	7230B	110.6	164	256	2.5	9.75
	270	45	3	1.1	338	303	—	—	10.8	—	14.7	3 700	4 900	7230C	50.6	164	256	2.5	9.75
	320	65	4	1.5	434	414	—	—	14.0	—	—	2 300	2 900	7330	100.3	168	302	3	22.4
	320	65	4	1.5	397	380	—	—	12.8	—	—	1 800	2 300	7330B	131.1	168	302	3	22.4

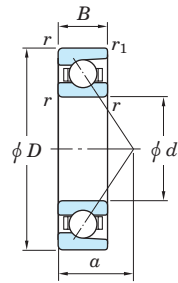
[Notes] 1) Limiting speeds shown above are applicable to machined cage bearings. Limiting speeds of pressed cage bearings should be kept to under 80% of this value. For bearings with 15° contact angle, this figure is applied to the high precision bearings ranked higher than class 5, used with machined cage or molded cage.

2) B, C or no indication after the bearing number indicates nominal contact angle of 40°, 15° and 30° respectively.

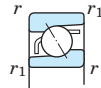
[Remark] Standard cage types used for the above bearings are described earlier in this section.

Single-row angular contact ball bearings

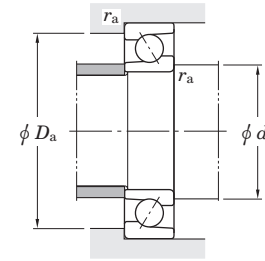
$d$  (150) ~ (180) mm



With machined cage



With pressed cage



Boundary dimensions (mm)					Basic load ratings (kN)				Fatigue load limits (kN)		Factor	Limiting speeds <sup>1)</sup> (min <sup>-1</sup> )		Bearing No. <sup>2)</sup>	Load center (mm) $a$	Mounting dimensions (mm)			(Refer.) Mass (kg)
$d$	$D$	$B$	$r$ min.	$r_1$ min.	With machined cage		With pressed cage		$C_u$			Grease lub.	Oil lub.			$d_a$ min.	$D_a$ max.	$r_a$ max.	
<b>150</b>	320	65	4	1.5	468	445	—	—	15.0	—	13.7	3 200	4 300	<b>7330C</b>	64.0	168	302	3	22.4
<b>160</b>	220	28	2	1	151	144	—	—	5.45	—	16.5	4 400	5 800	<b>7932C</b>	39.5	170	210	2	2.60
	240	38	2.1	1.1	194	176	—	—	6.65	—	—	2 800	3 500	<b>7032</b>	76.8	172	228	2	5.45
	240	38	2.1	1.1	173	158	—	—	5.80	—	—	2 100	2 800	<b>7032B</b>	102.9	172	228	2	5.45
	240	38	2.1	1.1	214	193	—	—	7.50	—	16.0	3 900	5 200	<b>7032C</b>	45.8	172	228	2	5.45
	290	48	3	1.1	288	263	—	—	9.05	—	—	2 500	3 100	<b>7232</b>	89.0	174	276	2.5	12.1
	290	48	3	1.1	297	279	—	—	9.60	—	—	1 800	2 500	<b>7232B</b>	118.4	174	276	2.5	12.1
	290	48	3	1.1	315	333	—	—	9.85	—	15.2	3 400	4 500	<b>7232C</b>	54.1	174	276	2.5	12.1
	340	68	4	1.5	456	455	—	—	14.9	—	—	2 200	2 700	<b>7332</b>	106.2	178	322	3	26.4
	340	68	4	1.5	415	416	—	—	13.6	—	—	1 600	2 200	<b>7332B</b>	138.9	178	322	3	26.4
340	68	4	1.5	492	490	—	—	16.0	—	14.0	3 000	4 000	<b>7332C</b>	67.5	168.5	322	3	26.4	
<b>170</b>	230	28	2	1	157	151	—	—	5.75	—	16.6	3 900	5 100	<b>7934C</b>	40.8	180	220	2	3.21
	260	42	2.1	1.1	232	214	—	—	7.90	—	—	2 600	3 200	<b>7034</b>	83.1	182	248	2	7.58
	260	42	2.1	1.1	208	193	—	—	6.90	—	—	1 900	2 600	<b>7034B</b>	111.2	182	248	2	7.77
	260	42	2.1	1.1	256	234	—	—	8.95	—	15.9	3 600	4 800	<b>7034C</b>	49.8	182	248	2	7.57
	310	52	4	1.5	340	331	—	—	11.0	—	—	2 300	2 800	<b>7234</b>	95.3	188	292	3	15.1
	310	52	4	1.5	306	300	—	—	10.0	—	—	1 700	2 300	<b>7234B</b>	126.7	188	292	3	15.1
	310	52	4	1.5	371	359	—	—	12.0	—	15.1	3 100	4 200	<b>7234C</b>	58.2	188	292	3	15.1
	360	72	4	1.5	486	485	—	—	15.4	—	—	2 000	2 500	<b>7334</b>	112.5	188	342	3	31.2
	360	72	4	1.5	444	444	—	—	14.1	—	—	1 500	2 000	<b>7334B</b>	147.2	188	342	3	31.2
360	72	4	1.5	523	521	—	—	16.5	—	13.8	2 800	3 700	<b>7334C</b>	71.5	188	342	3	31.2	
<b>180</b>	250	33	2	1	200	188	—	—	7.05	—	16.4	3 600	4 700	<b>7936C</b>	45.3	190	240	2	4.68
	280	46	2.1	1.1	265	253	—	—	9.15	—	—	2 400	3 000	<b>7036</b>	89.4	192	268	2	10.1
	280	46	2.1	1.1	237	228	—	—	7.95	—	—	1 800	2 400	<b>7036B</b>	119.5	192	268	2	10.2
	280	46	2.1	1.1	291	276	—	—	10.4	—	15.7	3 300	4 400	<b>7036C</b>	53.8	192	268	2	9.96
	320	52	4	1.5	367	362	—	—	11.8	—	—	2 200	2 700	<b>7236</b>	98.2	198	302	3	15.7

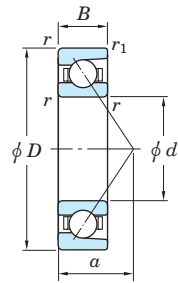
[Notes] 1) Limiting speeds shown above are applicable to machined cage bearings. Limiting speeds of pressed cage bearings should be kept to under 80% of this value. For bearings with 15° contact angle, this figure is applied to the high precision bearings ranked higher than class 5, used with machined cage or molded cage.

2) B, C or no indication after the bearing number indicates nominal contact angle of 40°, 15° and 30° respectively.

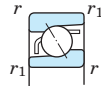
[Remark] Standard cage types used for the above bearings are described earlier in this section.

Single-row angular contact ball bearings

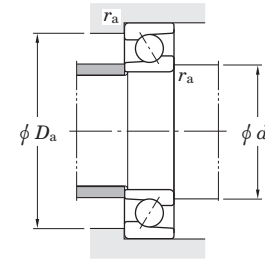
$d$  (180) ~ (240) mm



With machined cage



With pressed cage



Boundary dimensions (mm)					Basic load ratings (kN)				Fatigue load limits (kN)		Factor	Limiting speeds <sup>1)</sup> (min <sup>-1</sup> )		Bearing No. <sup>2)</sup>	Load center (mm) $a$	Mounting dimensions (mm)			(Refer.) Mass (kg)
$d$	$D$	$B$	$r$ min.	$r_1$ min.	With machined cage		With pressed cage		$C_u$			Grease lub.	Oil lub.			$d_a$ min.	$D_a$ max.	$r_a$ max.	
					$C_r$	$C_{0r}$	$C_r$	$C_{0r}$	[With machined cage]	[With pressed cage]	$f_0$								
<b>180</b>	320	52	4	1.5	331	329	—	—	10.7	—	—	1 600	2 200	<b>7236B</b>	130.9	198	302	3	15.7
	320	52	4	1.5	400	393	—	—	12.8	—	14.9	3 000	4 000	<b>7236C</b>	59.5	198	302	3	15.7
	380	75	4	1.5	512	534	—	—	16.5	—	—	1 900	2 400	<b>7336</b>	118.3	198	362	3	40.0
	380	75	4	1.5	466	488	—	—	15.1	—	—	1 400	1 900	<b>7336B</b>	155.0	198	362	3	40.0
<b>190</b>	260	33	2	1	198	197	—	—	6.85	—	16.5	3 300	4 500	<b>7938C</b>	46.6	200	250	2	4.83
	290	46	2.1	1.1	271	268	—	—	9.35	—	—	2 300	2 800	<b>7038</b>	92.3	202	278	2	10.8
	290	46	2.1	1.1	243	241	—	—	8.15	—	—	1 700	2 300	<b>7038B</b>	123.7	202	278	2	10.8
	290	46	2.1	1.1	299	293	—	—	10.6	—	15.9	3 100	4 200	<b>7038C</b>	55.2	202	278	2	10.8
	340	55	4	1.5	379	390	—	—	12.4	—	—	2 000	2 500	<b>7238</b>	104.0	208	322	3	18.8
	340	55	4	1.5	341	353	—	—	11.2	—	—	1 500	2 000	<b>7238B</b>	138.7	208	322	3	18.8
	340	55	4	1.5	414	424	—	—	13.5	—	15.1	2 800	3 700	<b>7238C</b>	63.0	208	322	3	18.8
	400	78	5	2	563	598	—	—	18.0	—	—	1 800	2 200	<b>7338</b>	124.2	212	378	4	45.5
400	78	5	2	514	548	—	—	16.5	—	—	1 300	1 800	<b>7338B</b>	162.8	212	378	4	45.5	
<b>200</b>	280	38	2.1	1.1	256	255	—	—	8.70	—	16.3	3 100	4 100	<b>7940C</b>	51.2	212	268	2	6.85
	310	51	2.1	1.1	304	309	—	—	10.0	—	—	2 100	2 600	<b>7040</b>	99.1	212	298	2	12.7
	310	51	2.1	1.1	273	279	—	—	9.05	—	—	1 600	2 100	<b>7040B</b>	132.5	212	298	2	12.7
	310	51	2.1	1.1	335	338	—	—	10.9	—	15.7	2 900	3 900	<b>7040C</b>	59.7	212	298	2	12.7
	360	58	4	1.5	405	423	—	—	13.1	—	—	1 900	2 400	<b>7240</b>	109.8	218	342	3	22.4
	360	58	4	1.5	365	384	—	—	11.9	—	—	1 400	1 900	<b>7240B</b>	146.5	218	342	3	22.4
	360	58	4	1.5	442	460	—	—	14.2	—	15.1	2 600	3 500	<b>7240C</b>	66.5	218	342	3	22.4
	420	80	5	2	593	658	—	—	19.3	—	—	1 700	2 100	<b>7340</b>	129.5	222	398	4	52.0
420	80	5	2	541	602	—	—	17.7	—	—	1 200	1 700	<b>7340B</b>	170.1	222	398	4	52.0	
<b>220</b>	340	56	3	1.1	334	353	—	—	10.9	—	—	1 900	2 400	<b>7044</b>	108.9	234	326	2.5	18.5
	340	56	3	1.1	299	318	—	—	9.80	—	—	1 400	1 900	<b>7044B</b>	145.5	234	326	2.5	18.9
<b>240</b>	360	56	3	1.1	364	375	—	—	12.3	—	—	1 700	2 200	<b>7048</b>	114.6	254	346	2.5	19.7
	360	56	3	1.1	325	338	—	—	11.1	—	—	1 300	1 700	<b>7048B</b>	153.9	254	346	2.5	20.1

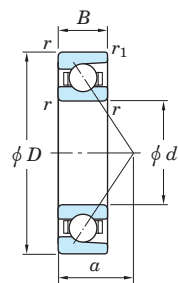
[Notes] 1) Limiting speeds shown above are applicable to machined cage bearings. Limiting speeds of pressed cage bearings should be kept to under 80% of this value. For bearings with 15° contact angle, this figure is applied to the high precision bearings ranked higher than class 5, used with machined cage or molded cage.

2) B, C or no indication after the bearing number indicates nominal contact angle of 40°, 15° and 30° respectively.

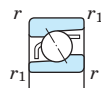
[Remark] Standard cage types used for the above bearings are described earlier in this section.

# Single-row angular contact ball bearings

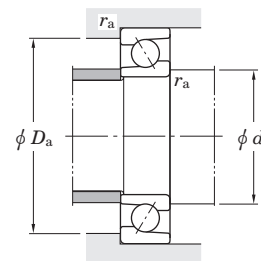
$d$  (240) ~ 380 mm



With machined cage



With pressed cage



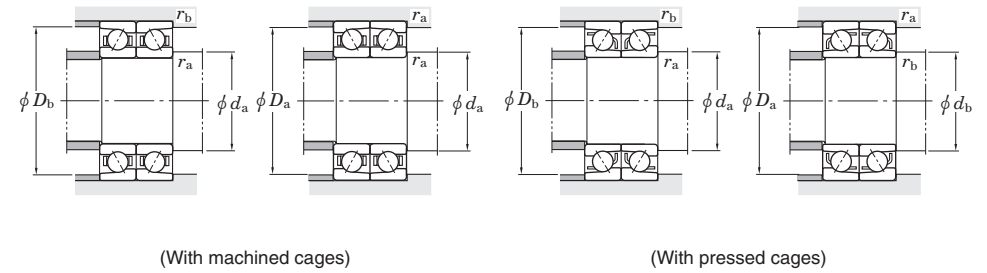
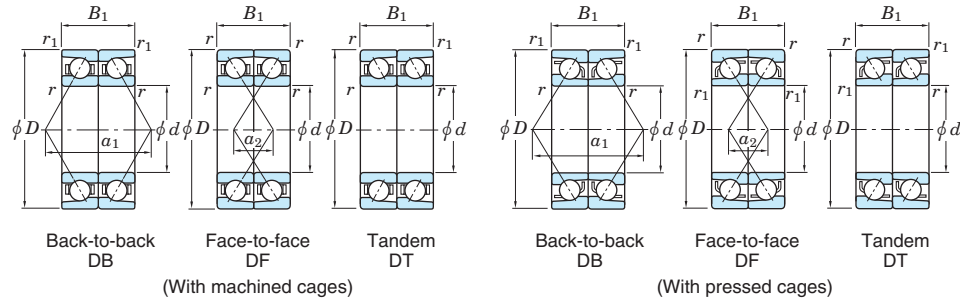
Boundary dimensions (mm)					Basic load ratings (kN)				Fatigue load limits (kN)		Factor	Limiting speeds <sup>1)</sup> (min <sup>-1</sup> )		Bearing No. <sup>2)</sup>	Load center (mm) $a$	Mounting dimensions (mm)			(Refer.) Mass (kg)
$d$	$D$	$B$	$r$ min.	$r_1$ min.	With machined cage		With pressed cage		$C_u$			Grease lub.	Oil lub.			$d_a$ min.	$D_a$ max.	$r_a$ max.	
					$C_r$	$C_{0r}$	$C_r$	$C_{0r}$	[With machined cage]	[With pressed cage]	$f_0$								
<b>240</b>	440	72	4	1.5	504	595	—	—	16.7	—	—	1 500	1 800	<b>7248</b>	134.2	258	422	3	51.8
	440	72	4	1.5	453	539	—	—	15.1	—	—	1 100	1 500	<b>7248B</b>	178.6	258	422	3	52.8
<b>260</b>	400	65	4	1.5	407	478	—	—	13.6	—	—	1 500	1 900	<b>7052</b>	128.4	278	382	3	28.7
	400	65	4	1.5	364	431	—	—	12.2	—	—	1 100	1 500	<b>7052B</b>	171.0	278	382	3	29.3
<b>280</b>	420	65	4	1.5	415	507	—	—	14.0	—	—	1 400	1 800	<b>7056</b>	133.5	298	402	3	30.4
	420	65	4	1.5	384	453	—	—	13.1	—	—	1 100	1 400	<b>7056B</b>	179.3	298	402	3	31.0
<b>300</b>	460	74	4	1.5	533	680	—	—	18.0	—	—	1 300	1 600	<b>7060</b>	146.7	318	442	3	43.7
	460	74	4	1.5	478	613	—	—	16.3	—	—	960	1 300	<b>7060B</b>	196.4	318	442	3	44.9
<b>320</b>	480	74	4	1.5	546	722	—	—	18.6	—	—	1 200	1 500	<b>7064</b>	152.5	338	462	3	46.0
	480	74	4	1.5	489	651	—	—	16.8	—	—	890	1 200	<b>7064B</b>	204.8	338	462	3	47.2
<b>340</b>	520	82	5	2	628	861	—	—	21.4	—	—	1 100	1 300	<b>7068</b>	165.1	362	498	4	61.8
	520	82	5	2	563	777	—	—	19.4	—	—	800	1 100	<b>7068B</b>	221.4	362	498	4	63.3
<b>360</b>	540	82	5	2	644	913	—	—	22.2	—	—	1 000	1 300	<b>7072</b>	170.9	382	518	4	64.6
	540	82	5	2	577	824	—	—	20.1	—	—	750	1 000	<b>7072B</b>	229.8	382	518	4	66.2
<b>380</b>	560	82	5	2	660	966	—	—	23.0	—	—	940	1 200	<b>7076</b>	176.7	402	538	4	67.2
	560	82	5	2	590	870	—	—	20.7	—	—	700	940	<b>7076B</b>	238.2	402	538	4	69.1

[Notes] 1) Limiting speeds shown above are applicable to machined cage bearings. Limiting speeds of pressed cage bearings should be kept to under 80% of this value. For bearings with 15° contact angle, this figure is applied to the high precision bearings ranked higher than class 5, used with machined cage or molded cage.

2) B or no indication after the bearing number indicates nominal contact angle of 15° and 30° respectively.  
[Remark] Standard cage types used for the above bearings are described earlier in this section.

Angular contact ball bearings (matched pair)

d 10 ~ (17) mm



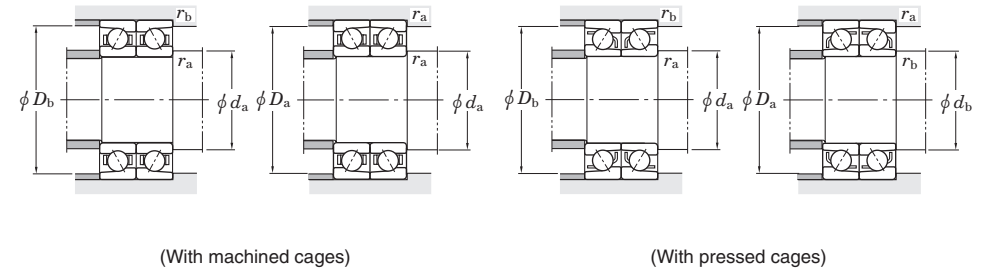
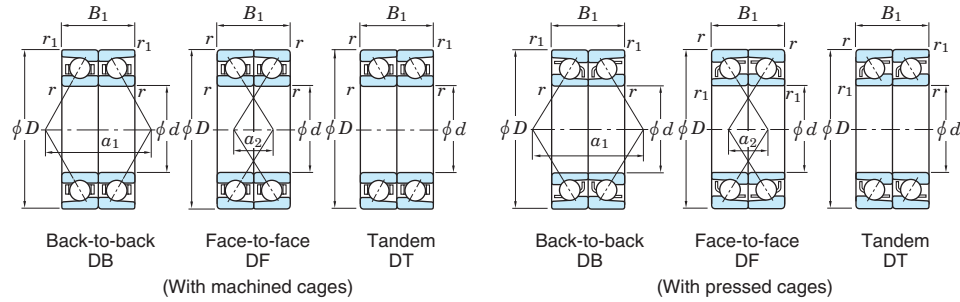
Boundary dimensions (mm)					Basic load ratings (kN)				Fatigue load limits (kN)		Factor	Limiting speeds <sup>1)</sup> (min <sup>-1</sup> )		Bearing No. <sup>2)</sup>			Load center spread (mm)		Mounting dimensions (mm)						(Refer.) Mass (kg)
d	D	B <sub>1</sub>	r min.	r <sub>1</sub> min.	C <sub>r</sub>	C <sub>0r</sub>	C <sub>r</sub>	C <sub>0r</sub>	C <sub>u</sub> (With machined cages)	C <sub>u</sub> (With pressed cages)	f <sub>0</sub>	Grease lub.	Oil lub.	Back-to-back DB	Face-to-face DF	Tandem DT	a <sub>1</sub>	a <sub>2</sub>	d <sub>a</sub> min.	d <sub>b</sub> min.	D <sub>a</sub> max.	D <sub>b</sub> max.	r <sub>a</sub> max.	r <sub>b</sub> max.	
10	22	12	0.3	0.15	6.10	3.05	—	—	0.120	—	14.2	42 000	55 000	7900CDB	7900CDF	7900CDT	10.3	1.7	12.5	—	19.5	20.8	0.3	0.15	0.016
	26	16	0.3	0.15	10.1	4.65	—	—	0.240	—	—	27 000	34 000	7000DB	7000DF	7000DT	18.2	2.2	12.5	—	23.5	24.8	0.3	0.15	0.042
	26	16	0.3	0.15	9.40	4.35	—	—	0.220	—	—	20 000	27 000	7000BDB	7000BDF	7000BDT	23.1	7.1	12.5	—	23.5	24.8	0.3	0.15	0.042
	26	16	0.3	0.15	10.7	4.95	—	—	0.250	—	12.5	37 000	50 000	7000CDB	7000CDF	7000CDT	12.7	3.3	12.5	—	23.5	24.8	0.3	0.15	0.042
	30	18	0.6	0.3	9.50	4.40	11.0	5.45	0.230	0.280	—	23 000	29 000	7200DB	7200DF	7200DT	20.8	2.8	14.5	12.5	25.5	27.5	0.6	0.3	0.062
	30	18	0.6	0.3	8.70	4.05	10.1	5.05	0.210	0.260	—	18 000	23 000	7200BDB	7200BDF	7200BDT	26.2	8.2	14.5	12.5	25.5	27.5	0.6	0.3	0.062
	30	18	0.6	0.3	10.2	4.70	11.8	5.85	0.240	0.300	13.4	32 000	43 000	7200CDB	7200CDF	7200CDT	14.5	3.5	14.5	12.5	25.5	27.5	0.6	0.3	0.062
	35	22	0.6	0.3	17.3	7.55	18.9	8.60	0.590	0.680	—	—	21 000	27 000	7300DB	7300DF	7300DT	24.0	2.0	14.5	12.5	30.5	32.5	0.6	0.3
12	24	12	0.3	0.15	6.45	3.45	—	—	0.140	—	14.7	37 000	49 000	7901CDB	7901CDF	7901CDT	10.8	1.2	14.5	—	21.5	22.8	0.3	0.15	0.020
	28	16	0.3	0.15	11.0	5.45	—	—	0.280	—	—	23 000	29 000	7001DB	7001DF	7001DT	19.9	3.9	14.5	—	25.5	26.8	0.3	0.15	0.048
	28	16	0.3	0.15	10.1	5.05	—	—	0.260	—	—	18 000	23 000	7001BDB	7001BDF	7001BDT	25.2	9.2	14.5	—	25.5	26.8	0.3	0.15	0.048
	28	16	0.3	0.15	11.8	5.85	—	—	0.300	—	13.4	32 000	43 000	7001CDB	7001CDF	7001CDT	13.5	2.5	14.5	—	25.5	26.8	0.3	0.15	0.048
	32	20	0.6	0.3	15.1	7.25	16.2	8.05	0.560	0.620	—	22 000	27 000	7201DB	7201DF	7201DT	22.7	2.7	16.5	14.5	27.5	29.5	0.6	0.3	0.076
	32	20	0.6	0.3	14.0	6.80	15.1	7.50	0.480	0.530	—	16 000	22 000	7201BDB	7201BDF	7201BDT	28.5	8.5	16.5	14.5	27.5	29.5	0.6	0.3	0.076
	32	20	0.6	0.3	16.0	7.70	17.2	8.55	0.600	0.670	12.5	30 000	40 000	7201CDB	7201CDF	7201CDT	15.9	4.1	16.5	14.5	27.5	29.5	0.6	0.3	0.076
	37	24	1	0.6	20.7	9.20	22.7	10.5	0.720	0.820	—	20 000	24 000	7301DB	7301DF	7301DT	26.2	2.2	17.5	16.5	31.5	32.5	1	0.6	0.130
15	28	14	0.3	0.15	9.65	5.30	—	—	0.210	—	14.5	31 000	41 000	7902CDB	7902CDF	7902CDT	12.8	1.2	17.5	—	25.5	26.8	0.3	0.15	0.030
	32	18	0.3	0.15	12.4	6.85	—	—	0.350	—	—	20 000	26 000	7002DB	7002DF	7002DT	22.6	4.6	17.5	—	29.5	30.8	0.3	0.15	0.070
	32	18	0.3	0.15	11.3	6.30	—	—	0.320	—	—	15 000	20 000	7002BDB	7002BDF	7002BDT	29.1	11.1	17.5	—	29.5	30.8	0.3	0.15	0.070
	32	18	0.3	0.15	13.4	7.40	—	—	0.380	—	14.1	28 000	37 000	7002CDB	7002CDF	7002CDT	15.3	2.7	17.5	—	29.5	30.8	0.3	0.15	0.070
	35	22	0.6	0.3	16.4	8.55	16.4	8.55	0.600	0.600	—	19 000	24 000	7202DB	7202DF	7202DT	25.7	3.7	19.5	17.5	30.5	32.5	0.6	0.3	0.096
	35	22	0.6	0.3	15.1	7.85	15.1	7.85	0.520	0.520	—	14 000	19 000	7202BDB	7202BDF	7202BDT	32.4	10.4	19.5	17.5	30.5	32.5	0.6	0.3	0.096
	35	22	0.6	0.3	17.6	9.15	17.6	9.15	0.680	0.680	13.3	26 000	35 000	7202CDB	7202CDF	7202CDT	17.8	4.2	19.5	17.5	30.5	32.5	0.6	0.3	0.096
	42	26	1	0.6	25.4	12.9	27.3	14.4	0.990	1.10	—	16 000	20 000	7302DB	7302DF	7302DT	30.0	4.0	20.5	19.5	36.5	37.5	1	0.6	0.176
17	30	14	0.3	0.15	10.1	5.90	—	—	0.240	—	14.9	28 000	38 000	7903CDB	7903CDF	7903CDT	13.4	0.6	19.5	—	27.5	28.8	0.3	0.15	0.032
	35	20	0.3	0.15	13.7	8.25	—	—	0.430	—	—	18 000	23 000	7003DB	7003DF	7003DT	25.3	5.3	19.5	—	32.5	33.8	0.3	0.15	0.090
	35	20	0.3	0.15	12.4	7.50	—	—	0.390	—	—	14 000	18 000	7003BDB	7003BDF	7003BDT	32.2	12.2	19.5	—	32.5	33.8	0.3	0.15	0.090

[Notes] 1) Limiting speeds shown above are applicable to machined cage bearings. Limiting speeds of pressed cage bearings should be kept to under 80% of this value. For bearings with 15° contact angle, this figure is applied to the high precision bearings ranked higher than class 5, used with machined cages or molded cages.

2) B, C or no indication after the bearing number indicates nominal contact angle of 40°, 15° and 30° respectively. [Remark] Standard cage types used for the above bearings are described earlier in this section.

Angular contact ball bearings (matched pair)

d (17) ~ (25) mm



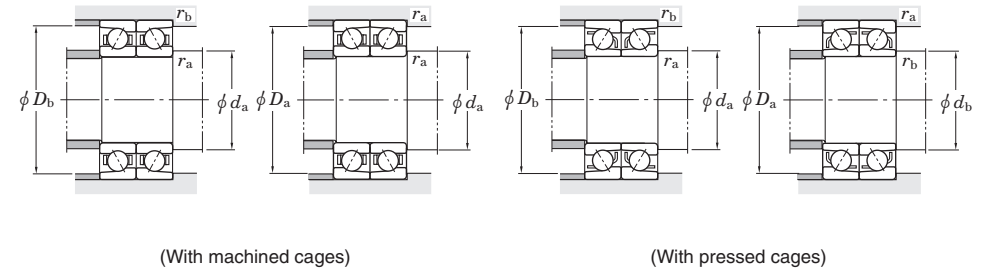
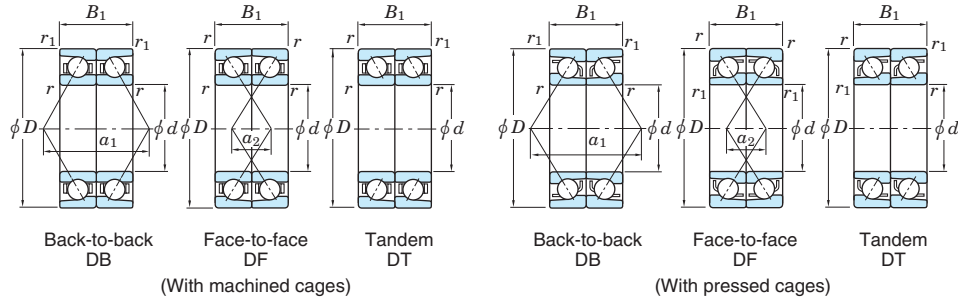
Boundary dimensions (mm)					Basic load ratings (kN)				Fatigue load limits (kN)		Factor $f_0$	Limiting speeds <sup>1)</sup> (min <sup>-1</sup> )		Bearing No. <sup>2)</sup>			Load center spread (mm)		Mounting dimensions (mm)						(Refer.) Mass (kg)
d	D	B <sub>1</sub>	r <sub>min.</sub>	r <sub>1 min.</sub>	With machined cages		With pressed cages		C <sub>u</sub> (With machined cages)	C <sub>u</sub> (With pressed cages)		Grease lub.	Oil lub.	Back-to-back DB	Face-to-face DF	Tandem DT	a <sub>1</sub>	a <sub>2</sub>	d <sub>a min.</sub>	d <sub>b min.</sub>	D <sub>a max.</sub>	D <sub>b max.</sub>	r <sub>a max.</sub>	r <sub>b max.</sub>	
17	35	20	0.3	0.15	14.8	8.95	—	—	0.460	—	14.6	25 000	33 000	7003CDB	7003CDF	7003CDT	17.1	2.9	19.5	—	32.5	33.8	0.3	0.15	0.090
	40	24	0.6	0.3	20.6	11.0	20.6	11.0	0.770	0.770	—	17 000	21 000	7203DB	7203DF	7203DT	28.8	4.8	21.5	19.5	35.5	37.5	0.6	0.3	0.140
	40	24	0.6	0.3	19.0	10.1	19.0	10.1	0.660	0.660	—	12 000	17 000	7203BDB	7203BDF	7203BDT	36.3	12.3	21.5	19.5	35.5	37.5	0.6	0.3	0.140
	40	24	0.6	0.3	22.1	11.8	22.1	11.8	0.880	0.880	13.4	23 000	30 000	7203CDB	7203CDF	7203CDT	19.8	4.2	21.5	19.5	35.5	37.5	0.6	0.3	0.140
	47	28	1	0.6	30.3	15.8	32.5	17.5	1.20	1.30	—	15 000	18 000	7303DB	7303DF	7303DT	33.1	5.1	22.5	21.5	41.5	42.5	1	0.6	0.240
	47	28	1	0.6	28.1	14.6	30.1	16.2	1.00	1.15	—	11 000	15 000	7303BDB	7303BDF	7303BDT	41.7	13.7	22.5	21.5	41.5	42.5	1	0.6	0.240
	47	28	1	0.6	32.2	16.8	32.2	16.8	1.30	1.30	12.6	20 000	27 000	7303CDB	7303CDF	7303CDT	22.8	5.2	22.5	21.5	41.5	42.5	1	0.6	0.240
20	37	18	0.3	0.15	14.8	9.15	—	—	0.470	—	14.9	24 000	31 000	7904CDB	7904CDF	7904CDT	16.6	1.4	22.5	—	34.5	35.8	0.3	0.15	0.070
	42	24	0.6	0.3	20.9	12.2	—	—	0.790	—	—	15 000	19 000	7004DB	7004DF	7004DT	30.2	6.2	24.5	—	37.5	39.5	0.6	0.3	0.158
	42	24	0.6	0.3	19.0	11.1	—	—	0.680	—	—	11 000	15 000	7004BDB	7004BDF	7004BDT	38.4	14.4	24.5	—	37.5	39.5	0.6	0.3	0.158
	42	24	0.6	0.3	22.6	13.2	—	—	0.900	—	14.1	21 000	28 000	7004CDB	7004CDF	7004CDT	20.4	3.6	24.5	—	37.5	39.5	0.6	0.3	0.158
	47	28	1	0.6	29.4	16.8	31.2	18.3	1.15	1.25	—	14 000	17 000	7204DB	7204DF	7204DT	33.9	5.9	25.5	24.5	41.5	42.5	1	0.6	0.224
	47	28	1	0.6	27.0	15.4	28.6	16.8	1.00	1.10	—	10 000	14 000	7204BDB	7204BDF	7204BDT	42.9	14.9	25.5	24.5	41.5	42.5	1	0.6	0.224
	47	28	1	0.6	31.5	18.0	33.4	19.6	1.35	1.45	13.4	19 000	26 000	7204CDB	7204CDF	7204CDT	23.2	4.8	25.5	24.5	41.5	42.5	1	0.6	0.224
	52	30	1.1	0.6	35.4	18.8	38.0	20.8	1.40	1.60	—	13 000	17 000	7304DB	7304DF	7304DT	35.8	5.8	27	24.5	45	47.5	1	0.6	0.300
	52	30	1.1	0.6	32.8	17.4	35.2	19.3	1.20	1.35	—	10 000	13 000	7304BDB	7304BDF	7304BDT	45.2	15.2	27	24.5	45	47.5	1	0.6	0.300
	52	30	1.1	0.6	37.6	19.9	40.3	22.2	1.55	1.75	12.6	18 000	24 000	7304CDB	7304CDF	7304CDT	24.6	5.4	27	24.5	45	47.5	1	0.6	0.300
	72	38	1.1	0.6	72.3	38.2	—	—	3.00	—	—	7 400	11 000	7404DB	7404DF	7404DT	46.1	8.1	27	—	65	67.5	1	0.6	0.790
	72	38	1.1	0.6	68.1	35.9	—	—	2.80	—	—	6 400	9 600	7404BDB	7404BDF	7404BDT	58.4	20.4	27	—	65	67.5	1	0.6	0.790
	25	42	18	0.3	0.15	16.5	10.9	—	—	0.600	—	15.5	20 000	27 000	7905CDB	7905CDF	7905CDT	18.2	0.2	27.5	—	39.5	40.8	0.3	0.15
47		24	0.6	0.3	22.9	14.8	—	—	0.900	—	—	13 000	17 000	7005DB	7005DF	7005DT	32.9	8.9	29.5	—	42.5	44.5	0.6	0.3	0.182
47		24	0.6	0.3	20.7	13.4	—	—	0.780	—	—	10 000	13 000	7005BDB	7005BDF	7005BDT	42.3	18.3	29.5	—	42.5	44.5	0.6	0.3	0.182
47		24	0.6	0.3	24.9	16.0	—	—	1.00	—	14.7	18 000	24 000	7005CDB	7005CDF	7005CDT	21.7	2.3	29.5	—	42.5	44.5	0.6	0.3	0.182
52		30	1	0.6	31.2	19.0	32.9	20.6	1.25	1.35	—	12 000	15 000	7205DB	7205DF	7205DT	37.5	7.5	30.5	29.5	46.5	47.5	1	0.6	0.270
52		30	1	0.6	28.4	17.4	29.9	18.8	1.05	1.15	—	9 200	12 000	7205BDB	7205BDF	7205BDT	47.7	17.7	30.5	29.5	46.5	47.5	1	0.6	0.270
52		30	1	0.6	33.7	20.5	35.5	22.2	1.40	1.55	14.0	17 000	23 000	7205CDB	7205CDF	7205CDT	25.5	4.5	30.5	29.5	46.5	47.5	1	0.6	0.270
62		34	1.1	0.6	50.3	28.8	53.6	31.6	2.10	2.35	—	11 000	14 000	7305DB	7305DF	7305DT	42.1	8.1	32	29.5	55	57.5	1	0.6	0.486

[Notes] 1) Limiting speeds shown above are applicable to machined cage bearings. Limiting speeds of pressed cage bearings should be kept to under 80% of this value. For bearings with 15° contact angle, this figure is applied to the high precision bearings ranked higher than class 5, used with machined cages or molded cages.

2) B, C or no indication after the bearing number indicates nominal contact angle of 40°, 15° and 30° respectively. [Remark] Standard cage types used for the above bearings are described earlier in this section.

Angular contact ball bearings (matched pair)

d (25) ~ (35) mm



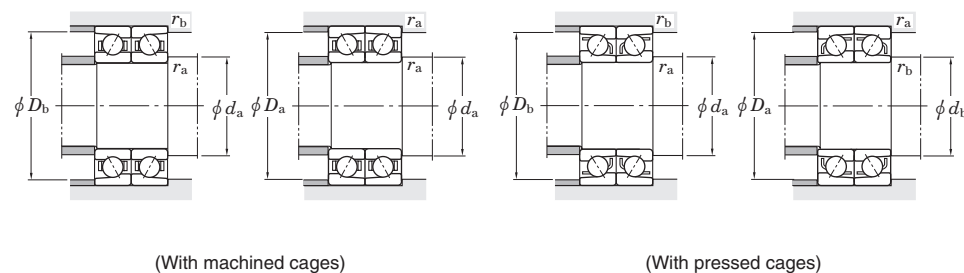
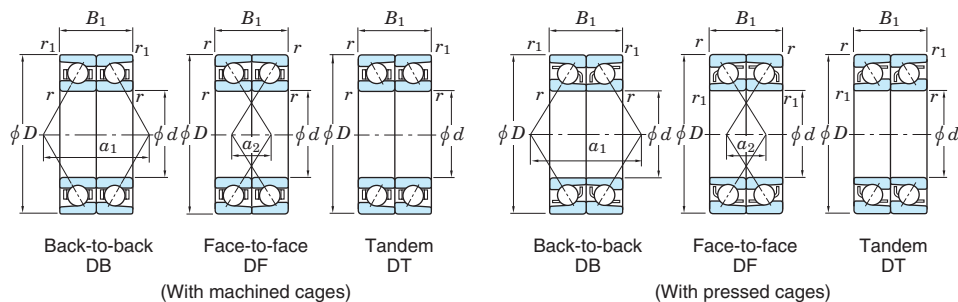
Boundary dimensions (mm)					Basic load ratings (kN)				Fatigue load limits (kN)		Factor $f_0$	Limiting speeds <sup>1)</sup> (min <sup>-1</sup> )		Bearing No. <sup>2)</sup>			Load center spread (mm)		Mounting dimensions (mm)						(Refer.) Mass (kg)
d	D	B <sub>1</sub>	r min.	r <sub>1</sub> min.	With machined cages		With pressed cages		C <sub>u</sub> (With machined cages)	C <sub>u</sub> (With pressed cages)		Grease lub.	Oil lub.	Back-to-back DB	Face-to-face DF	Tandem DT	a <sub>1</sub>	a <sub>2</sub>	d <sub>a</sub> min.	d <sub>b</sub> min.	D <sub>a</sub> max.	D <sub>b</sub> max.	r <sub>a</sub> max.	r <sub>b</sub> max.	
25	62	34	1.1	0.6	46.5	26.6	49.5	29.2	1.85	2.00	—	8 300	11 000	<b>7305BDB</b>	<b>7305BDF</b>	<b>7305BDT</b>	53.5	19.5	32	29.5	55	57.5	1	0.6	0.486
	62	34	1.1	0.6	53.5	30.6	57.0	33.7	2.40	2.65	12.8	15 000	20 000	<b>7305CDB</b>	<b>7305CDF</b>	<b>7305CDT</b>	28.7	5.3	32	29.5	55	57.5	1	0.6	0.486
	80	42	1.5	1	80.7	46.3	86.6	51.5	3.60	4.00	—	6 400	9 100	<b>7405DB</b>	<b>7405DF</b>	<b>7405DT</b>	52.8	10.8	33.5	30.5	71.5	74.5	1.5	1	1.05
	80	42	1.5	1	74.9	43.0	80.4	47.8	3.10	3.40	—	5 500	8 200	<b>7405BDB</b>	<b>7405BDF</b>	<b>7405BDT</b>	67.2	25.2	33.5	30.5	71.5	74.5	1.5	1	1.05
30	47	18	0.3	0.15	16.8	12.5	—	—	0.650	—	15.9	18 000	23 000	<b>7906CDB</b>	<b>7906CDF</b>	<b>7906CDT</b>	19.3	1.3	32.5	—	44.5	45.8	0.3	0.15	0.092
	55	26	1	0.6	29.5	20.2	—	—	1.20	—	—	11 000	14 000	<b>7006DB</b>	<b>7006DF</b>	<b>7006DT</b>	37.5	11.5	35.5	—	49.5	50.5	1	0.6	0.266
	55	26	1	0.6	26.7	18.4	—	—	1.05	—	—	8 500	11 000	<b>7006BDB</b>	<b>7006BDF</b>	<b>7006BDT</b>	48.7	22.7	35.5	—	49.5	50.5	1	0.6	0.266
	55	26	1	0.6	32.2	22.0	—	—	1.40	—	14.9	16 000	21 000	<b>7006CDB</b>	<b>7006CDF</b>	<b>7006CDT</b>	24.4	1.6	35.5	—	49.5	50.5	1	0.6	0.266
	62	32	1	0.6	43.3	27.4	45.7	29.7	1.80	1.95	—	10 000	13 000	<b>7206DB</b>	<b>7206DF</b>	<b>7206DT</b>	43.0	11.0	35.5	34.5	56.5	57.5	1	0.6	0.416
	62	32	1	0.6	39.5	25.0	41.6	27.1	1.55	1.65	—	7 700	10 000	<b>7206BDB</b>	<b>7206BDF</b>	<b>7206BDT</b>	55.2	23.2	35.5	34.5	56.5	57.5	1	0.6	0.416
	62	32	1	0.6	46.8	29.5	49.4	32.0	2.05	2.20	14.0	14 000	19 000	<b>7206CDB</b>	<b>7206CDF</b>	<b>7206CDT</b>	28.5	3.5	35.5	34.5	56.5	57.5	1	0.6	0.416
	72	38	1.1	0.6	61.1	37.8	64.8	41.2	2.60	2.85	—	9 200	12 000	<b>7306DB</b>	<b>7306DF</b>	<b>7306DT</b>	49.0	11.0	37	34.5	65	67.5	1	0.6	0.724
	72	38	1.1	0.6	56.1	34.7	59.4	37.9	2.25	2.45	—	6 900	9 200	<b>7306BDB</b>	<b>7306BDF</b>	<b>7306BDT</b>	62.6	24.6	37	34.5	65	67.5	1	0.6	0.724
	72	38	1.1	0.6	65.6	40.5	69.5	44.2	3.00	3.25	13.4	13 000	17 000	<b>7306CDB</b>	<b>7306CDF</b>	<b>7306CDT</b>	32.9	5.1	37	34.5	65	67.5	1	0.6	0.724
	90	46	1.5	1	96.7	56.9	104	63.2	4.35	4.85	—	5 700	8 100	<b>7406DB</b>	<b>7406DF</b>	<b>7406DT</b>	58.5	12.5	38.5	35.5	81.5	84.5	1.5	1	1.37
	90	46	1.5	1	89.7	52.8	96.3	58.6	3.75	4.15	—	4 900	7 300	<b>7406BDB</b>	<b>7406BDF</b>	<b>7406BDT</b>	74.6	28.6	38.5	35.5	81.5	84.5	1.5	1	1.37
35	55	20	0.6	0.3	25.5	19.4	—	—	1.10	—	15.7	15 000	20 000	<b>7907CDB</b>	<b>7907CDF</b>	<b>7907CDT</b>	22.1	2.1	39.5	—	50.5	52.5	0.6	0.3	0.148
	62	28	1	0.6	35.5	25.2	—	—	1.50	—	—	9 800	12 000	<b>7007DB</b>	<b>7007DF</b>	<b>7007DT</b>	42.3	14.3	40.5	—	56.5	57.5	1	0.6	0.340
	62	28	1	0.6	32.0	22.8	—	—	1.30	—	—	7 300	9 800	<b>7007BDB</b>	<b>7007BDF</b>	<b>7007BDT</b>	55.1	27.1	40.5	—	56.5	57.5	1	0.6	0.340
	62	28	1	0.6	38.8	27.4	—	—	1.70	—	15.0	13 000	18 000	<b>7007CDB</b>	<b>7007CDF</b>	<b>7007CDT</b>	27.0	1.0	40.5	—	56.5	57.5	1	0.6	0.340
	72	34	1.1	0.6	57.1	37.3	60.3	40.4	2.45	2.65	—	8 800	11 000	<b>7207DB</b>	<b>7207DF</b>	<b>7207DT</b>	48.5	14.5	42	39.5	65	67.5	1	0.6	0.590
	72	34	1.1	0.6	52.1	34.1	54.9	36.9	2.10	2.25	—	6 600	8 800	<b>7207BDB</b>	<b>7207BDF</b>	<b>7207BDT</b>	62.7	28.7	42	39.5	65	67.5	1	0.6	0.590
	72	34	1.1	0.6	61.7	40.2	65.1	43.5	2.75	3.00	14.0	12 000	16 000	<b>7207CDB</b>	<b>7207CDF</b>	<b>7207CDT</b>	31.6	2.4	42	39.5	65	67.5	1	0.6	0.590
	80	42	1.5	1	71.8	44.0	81.1	52.8	3.05	3.65	—	8 200	10 000	<b>7307DB</b>	<b>7307DF</b>	<b>7307DT</b>	54.8	12.8	43.5	40.5	71.5	74.5	1.5	1	0.950
	80	42	1.5	1	65.9	40.5	74.4	48.6	2.65	3.15	—	6 200	8 200	<b>7307BDB</b>	<b>7307BDF</b>	<b>7307BDT</b>	70.1	28.1	43.5	40.5	71.5	74.5	1.5	1	0.950
	80	42	1.5	1	77.0	47.2	86.9	56.6	3.50	4.20	13.4	11 000	15 000	<b>7307CDB</b>	<b>7307CDF</b>	<b>7307CDT</b>	36.7	5.3	43.5	40.5	71.5	74.5	1.5	1	0.950
	100	50	1.5	1	123	73.9	132	82.1	5.70	6.35	—	5 000	7 200	<b>7407DB</b>	<b>7407DF</b>	<b>7407DT</b>	65.2	15.2	43.5	40.5	91.5	94.5	1.5	1	1.90

[Notes] 1) Limiting speeds shown above are applicable to machined cage bearings. Limiting speeds of pressed cage bearings should be kept to under 80% of this value. For bearings with 15° contact angle, this figure is applied to the high precision bearings ranked higher than class 5, used with machined cages or molded cages.

2) B, C or no indication after the bearing number indicates nominal contact angle of 40°, 15° and 30° respectively. [Remark] Standard cage types used for the above bearings are described earlier in this section.

# Angular contact ball bearings (matched pair)

d (35) ~ (50) mm



Boundary dimensions (mm)					Basic load ratings (kN)				Fatigue load limits (kN)		Factor	Limiting speeds <sup>1)</sup> (min <sup>-1</sup> )		Bearing No. <sup>2)</sup>			Load center spread (mm)		Mounting dimensions (mm)						(Refer.) Mass (kg)
d	D	B <sub>1</sub>	r <sub>min.</sub>	r <sub>1 min.</sub>	C <sub>r</sub>	C <sub>0r</sub>	C <sub>r</sub>	C <sub>0r</sub>	C <sub>u</sub> (With machined cages)	C <sub>u</sub> (With pressed cages)	f <sub>0</sub>	Grease lub.	Oil lub.	Back-to-back DB	Face-to-face DF	Tandem DT	a <sub>1</sub>	a <sub>2</sub>	d <sub>a min.</sub>	d <sub>b min.</sub>	D <sub>a max.</sub>	D <sub>b max.</sub>	r <sub>a max.</sub>	r <sub>b max.</sub>	
<b>35</b>	100	50	1.5	1	114	68.6	122	76.2	4.90	5.45	—	4 300	6 500	<b>7407BDB</b>	<b>7407BDF</b>	<b>7407BDT</b>	83.3	33.3	43.5	40.5	91.5	94.5	1.5	1	1.90
<b>40</b>	62	24	0.6	0.3	32.0	24.9	—	—	1.40	—	15.7	13 000	18 000	<b>7908CDB</b>	<b>7908CDF</b>	<b>7908CDT</b>	25.7	1.7	44.5	—	57.5	59.5	0.6	0.3	0.214
	68	30	1	0.6	38.1	29.2	—	—	1.65	—	—	8 900	11 000	<b>7008DB</b>	<b>7008DF</b>	<b>7008DT</b>	46.3	16.3	45.5	—	62.5	63.5	1	0.6	0.420
	68	30	1	0.6	34.2	26.4	—	—	1.45	—	—	6 600	8 900	<b>7008BDB</b>	<b>7008BDF</b>	<b>7008BDT</b>	60.5	30.5	45.5	—	62.5	63.5	1	0.6	0.420
	68	30	1	0.6	41.7	31.8	—	—	1.90	—	15.4	12 000	16 000	<b>7008CDB</b>	<b>7008CDF</b>	<b>7008CDT</b>	29.5	0.5	45.5	—	62.5	63.5	1	0.6	0.420
	80	36	1.1	0.6	68.2	46.7	71.7	50.3	3.00	3.25	—	8 000	10 000	<b>7208DB</b>	<b>7208DF</b>	<b>7208DT</b>	52.7	16.7	47	44.5	73	75.5	1	0.6	0.764
	80	36	1.1	0.6	62.1	42.7	65.2	45.9	2.60	2.80	—	6 000	8 000	<b>7208BDB</b>	<b>7208BDF</b>	<b>7208BDT</b>	68.3	32.3	47	44.5	73	75.5	1	0.6	0.764
	80	36	1.1	0.6	73.8	50.4	77.6	54.3	3.45	3.70	14.2	11 000	15 000	<b>7208CDB</b>	<b>7208CDF</b>	<b>7208CDT</b>	34.1	1.9	47	44.5	73	75.5	1	0.6	0.764
	90	46	1.5	1	87.8	54.9	99.1	65.9	3.85	4.60	—	7 400	9 200	<b>7308DB</b>	<b>7308DF</b>	<b>7308DT</b>	60.5	14.5	48.5	45.5	81.5	84.5	1.5	1	1.31
	90	46	1.5	1	80.6	50.5	91.0	60.6	3.30	3.95	—	5 500	7 400	<b>7308BDB</b>	<b>7308BDF</b>	<b>7308BDT</b>	77.5	31.5	48.5	45.5	81.5	84.5	1.5	1	1.31
	90	46	1.5	1	94.1	58.8	106	70.5	4.40	5.25	13.4	10 000	14 000	<b>7308CDB</b>	<b>7308CDF</b>	<b>7308CDT</b>	40.4	5.6	48.5	45.5	81.5	84.5	1.5	1	1.31
	110	54	2	1	142	87.1	152	96.8	6.70	7.45	—	4 600	6 600	<b>7408DB</b>	<b>7408DF</b>	<b>7408DT</b>	70.9	16.9	50	45.5	100	104.5	2	1	2.46
	110	54	2	1	132	80.8	141	89.8	5.75	6.40	—	3 900	5 900	<b>7408BDB</b>	<b>7408BDF</b>	<b>7408BDT</b>	90.8	36.8	50	45.5	100	104.5	2	1	2.46
<b>45</b>	68	24	0.6	0.3	33.7	28.2	—	—	1.55	—	16.0	12 000	16 000	<b>7909CDB</b>	<b>7909CDF</b>	<b>7909CDT</b>	27.1	3.1	49.5	—	63.5	65.5	0.6	0.3	0.254
	75	32	1	0.6	45.2	35.4	—	—	2.00	—	—	8 000	10 000	<b>7009DB</b>	<b>7009DF</b>	<b>7009DT</b>	50.7	18.7	50.5	—	69.5	70.5	1	0.6	0.520
	75	32	1	0.6	40.6	32.0	—	—	1.75	—	—	6 000	8 000	<b>7009BDB</b>	<b>7009BDF</b>	<b>7009BDT</b>	66.3	34.3	50.5	—	69.5	70.5	1	0.6	0.520
	75	32	1	0.6	49.6	38.5	—	—	2.25	—	15.4	11 000	15 000	<b>7009CDB</b>	<b>7009CDF</b>	<b>7009CDT</b>	32.1	0.1	50.5	—	69.5	70.5	1	0.6	0.520
	85	38	1.1	0.6	76.6	53.2	80.5	57.2	3.40	3.70	—	7 500	9 400	<b>7209DB</b>	<b>7209DF</b>	<b>7209DT</b>	56.0	18.0	52	49.5	78	80.5	1	0.6	0.860
	85	38	1.1	0.6	69.7	48.6	73.2	52.3	2.95	3.20	—	5 600	7 500	<b>7209BDB</b>	<b>7209BDF</b>	<b>7209BDT</b>	72.8	34.8	52	49.5	78	80.5	1	0.6	0.860
	85	38	1.1	0.6	82.9	57.4	87.1	61.8	3.90	4.20	14.2	10 000	14 000	<b>7209CDB</b>	<b>7209CDF</b>	<b>7209CDT</b>	36.2	1.8	52	49.5	78	80.5	1	0.6	0.860
	100	50	1.5	1	112	74.2	119	80.9	5.15	5.60	—	6 600	8 200	<b>7309DB</b>	<b>7309DF</b>	<b>7309DT</b>	67.2	17.2	53.5	50.5	91.5	94.5	1.5	1	1.75
	100	50	1.5	1	103	68.2	109	74.3	4.40	4.85	—	4 900	6 600	<b>7309BDB</b>	<b>7309BDF</b>	<b>7309BDT</b>	86.3	36.3	53.5	50.5	91.5	94.5	1.5	1	1.75
	100	50	1.5	1	120	79.5	127	86.7	5.85	6.40	13.5	9 000	12 000	<b>7309CDB</b>	<b>7309CDF</b>	<b>7309CDT</b>	44.6	5.4	53.5	50.5	91.5	94.5	1.5	1	1.75
	120	58	2	1	173	108	185	120	8.35	9.30	—	4 200	6 000	<b>7409DB</b>	<b>7409DF</b>	<b>7409DT</b>	77.2	19.2	55	50.5	110	114.5	2	1	3.10
	120	58	2	1	160	100	172	111	7.20	8.00	—	3 600	5 400	<b>7409BDB</b>	<b>7409BDF</b>	<b>7409BDT</b>	99.1	41.1	55	50.5	110	114.5	2	1	3.10
<b>50</b>	72	24	0.6	0.3	35.4	31.4	—	—	1.70	—	16.2	11 000	15 000	<b>7910CDB</b>	<b>7910CDF</b>	<b>7910CDT</b>	28.3	4.3	54.5	—	67.5	69.5	0.6	0.3	0.256
	80	32	1	0.6	48.0	40.2	—	—	2.20	—	—	7 300	9 200	<b>7010DB</b>	<b>7010DF</b>	<b>7010DT</b>	53.8	21.8	55.5	—	74.5	75.5	1	0.6	0.580

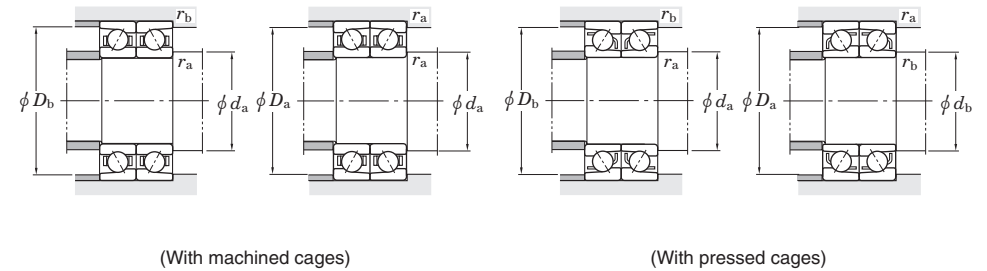
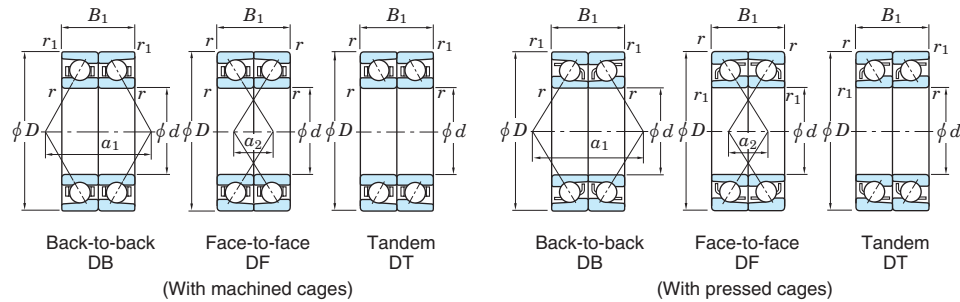
[Notes] 1) Limiting speeds shown above are applicable to machined cage bearings. Limiting speeds of pressed cage bearings should be kept to under 80% of this value. For bearings with 15° contact angle, this figure is applied to the high precision bearings ranked higher than class 5, used with machined cages or molded cages.

2) B, C or no indication after the bearing number indicates nominal contact angle of 40°, 15° and 30° respectively. [Remark] Standard cage types used for the above bearings are described earlier in this section.



# Angular contact ball bearings (matched pair)

$d$  (50) ~ (60) mm



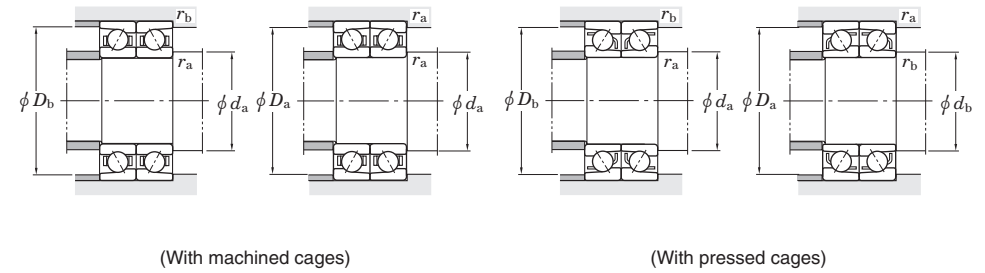
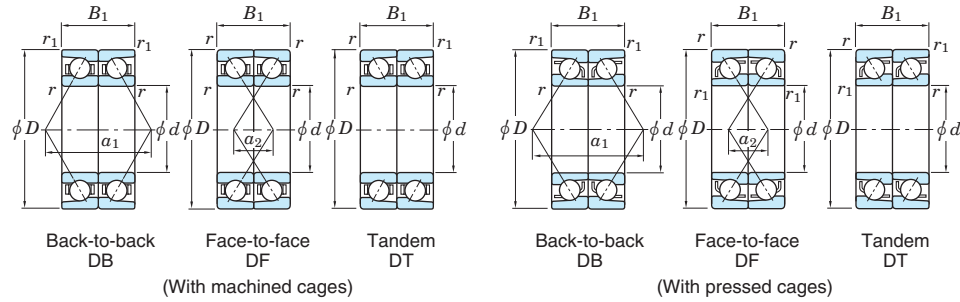
Boundary dimensions (mm)					Basic load ratings (kN)				Fatigue load limits (kN)		Factor $f_0$	Limiting speeds <sup>1)</sup> (min <sup>-1</sup> )		Bearing No. <sup>2)</sup>			Load center spread (mm)		Mounting dimensions (mm)						(Refer.) Mass (kg)	
$d$	$D$	$B_1$	$r$ min.	$r_1$ min.	With machined cages		With pressed cages		$C_u$	$C_{0r}$		$f_0$	Grease lub.	Oil lub.	Back-to-back DB	Face-to-face DF	Tandem DT	$a_1$	$a_2$	$d_a$ min.	$d_b$ min.	$D_a$ max.	$D_b$ max.	$r_a$ max.		$r_b$ max.
50	80	32	1	0.6	43.1	36.2	—	—	1.90	—	—	5 500	7 400	7010BDB	7010BDF	7010BDT	70.5	38.5	55.5	—	74.5	75.5	1	0.6	0.580	
	80	32	1	0.6	52.7	43.9	—	—	2.50	—	15.7	10 000	13 000	7010CDB	7010CDF	7010CDT	33.6	1.6	55.5	—	74.5	75.5	1	0.6	0.580	
	90	40	1.1	0.6	80.0	58.7	83.8	62.9	3.60	3.85	—	6 800	8 500	7210DB	7210DF	7210DT	60.7	20.7	57	54.5	83	85.5	1	0.6	0.970	
	90	40	1.1	0.6	72.5	53.5	75.9	57.3	3.15	3.35	—	5 100	6 800	7210BDB	7210BDF	7210BDT	79.2	39.2	57	54.5	83	85.5	1	0.6	0.970	
	90	40	1.1	0.6	86.9	63.6	91.0	68.1	4.10	4.40	14.6	9 400	12 000	7210CDB	7210CDF	7210CDT	38.9	1.1	57	54.5	83	85.5	1	0.6	0.970	
	110	54	2	1	142	96.3	151	105	6.70	7.35	—	5 800	7 300	7310DB	7310DF	7310DT	74.4	20.4	60	55.5	100	104.5	2	1	2.28	
	110	54	2	1	131	88.6	138	96.6	5.80	6.30	—	4 400	5 800	7310BDB	7310BDF	7310BDT	95.8	41.8	60	55.5	100	104.5	2	1	2.28	
	110	54	2	1	153	103	162	112	7.70	8.40	13.4	8 000	11 000	7310CDB	7310CDF	7310CDT	49.0	5.0	60	55.5	100	104.5	2	1	2.28	
	130	62	2.1	1.1	198	131	—	—	9.85	—	—	3 800	5 500	7410DB	7410DF	7410DT	83.3	21.3	62	—	118	123	2	1	3.84	
	130	62	2.1	1.1	183	121	—	—	8.45	—	—	3 300	4 900	7410BDB	7410BDF	7410BDT	106.9	44.9	62	—	118	123	2	1	3.84	
55	80	26	1	0.6	40.0	37.0	—	—	1.95	—	16.3	10 000	14 000	7911CDB	7911CDF	7911CDT	31.1	5.1	60.5	—	74.5	75.5	1	0.6	0.356	
	90	36	1.1	0.6	63.2	52.5	—	—	2.95	—	—	6 600	8 300	7011DB	7011DF	7011DT	59.9	23.9	62	—	83	85.5	1	0.6	0.840	
	90	36	1.1	0.6	56.7	47.5	—	—	2.55	—	—	5 000	6 600	7011BDB	7011BDF	7011BDT	78.8	42.8	62	—	83	85.5	1	0.6	0.840	
	90	36	1.1	0.6	69.3	57.3	—	—	3.35	—	15.5	9 100	12 000	7011CDB	7011CDF	7011CDT	37.4	1.4	62	—	83	85.5	1	0.6	0.840	
	100	42	1.5	1	98.9	74.2	104	79.6	4.60	4.90	—	6 100	7 600	7211DB	7211DF	7211DT	66.6	24.6	63.5	60.5	91.5	94.5	1.5	1	1.27	
	100	42	1.5	1	89.6	67.6	93.8	72.4	3.95	4.25	—	4 600	6 100	7211BDB	7211BDF	7211BDT	87.3	45.3	63.5	60.5	91.5	94.5	1.5	1	1.27	
	100	42	1.5	1	107	80.4	112	86.1	5.20	5.60	14.6	8 400	11 000	7211CDB	7211CDF	7211CDT	42.2	0.2	63.5	60.5	91.5	94.5	1.5	1	1.27	
	120	58	2	1	164	113	174	123	7.90	8.60	—	5 400	6 700	7311DB	7311DF	7311DT	80.4	22.4	65	60.5	110	114.5	2	1	2.90	
	120	58	2	1	151	104	160	113	6.80	7.40	—	4 000	5 400	7311BDB	7311BDF	7311BDT	103.7	45.7	65	60.5	110	114.5	2	1	2.90	
	120	58	2	1	176	121	187	132	9.00	9.85	13.4	7 400	9 800	7311CDB	7311CDF	7311CDT	52.9	5.1	65	60.5	110	114.5	2	1	2.90	
	140	66	2.1	1.1	241	165	—	—	12.8	—	—	3 500	5 000	7411DB	7411DF	7411DT	89.9	23.9	67	—	128	133	2	1	4.72	
	140	66	2.1	1.1	224	153	—	—	11.0	—	—	3 000	4 500	7411BDB	7411BDF	7411BDT	115.7	49.7	67	—	128	133	2	1	4.72	
	60	85	26	1	0.6	47.2	43.6	—	—	2.35	—	16.3	9 100	13 000	7912CDB	7912CDF	7912CDT	32.6	6.6	65.5	—	79.5	80.5	1	0.6	0.374
		95	36	1.1	0.6	64.8	56.1	—	—	3.10	—	—	6 200	7 700	7012DB	7012DF	7012DT	62.8	26.8	67	—	88	90.5	1	0.6	0.900
95		36	1.1	0.6	58.1	50.7	—	—	2.70	—	—	4 600	6 200	7012BDB	7012BDF	7012BDT	83.0	47.0	67	—	88	90.5	1	0.6	0.900	
95		36	1.1	0.6	71.2	61.3	—	—	3.50	—	15.7	8 500	11 000	7012CDB	7012CDF	7012CDT	38.8	2.8	67	—	88	90.5	1	0.6	0.900	
110		44	1.5	1	120	91.5	125	98.0	5.65	6.05	—	5 500	6 900	7212DB	7212DF	7212DT	72.3	28.3	68.5	65.5	101.5	104.5	1.5	1	1.64	

[Notes] 1) Limiting speeds shown above are applicable to machined cage bearings. Limiting speeds of pressed cage bearings should be kept to under 80% of this value. For bearings with 15° contact angle, this figure is applied to the high precision bearings ranked higher than class 5, used with machined cages or molded cages.

2) B, C or no indication after the bearing number indicates nominal contact angle of 40°, 15° and 30° respectively. [Remark] Standard cage types used for the above bearings are described earlier in this section.

# Angular contact ball bearings (matched pair)

$d$  (60) ~ (70) mm



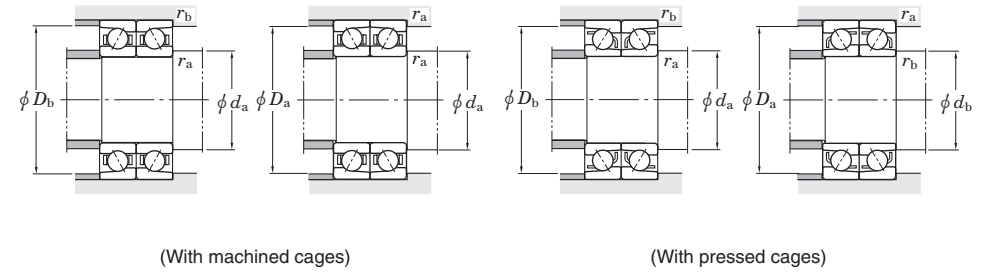
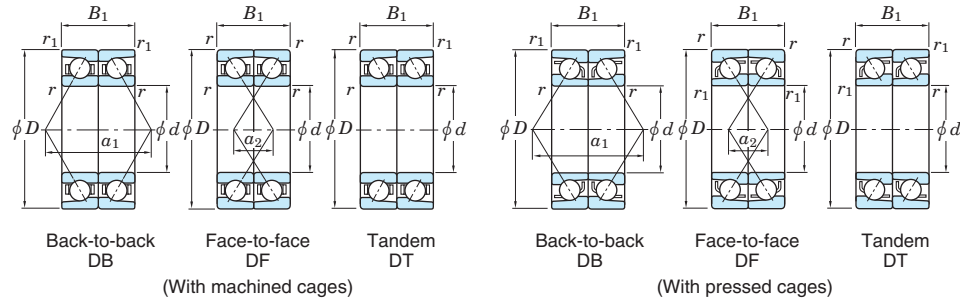
Boundary dimensions (mm)					Basic load ratings (kN)				Fatigue load limits (kN)		Factor $f_0$	Limiting speeds <sup>1)</sup> (min <sup>-1</sup> )		Bearing No. <sup>2)</sup>			Load center spread (mm)		Mounting dimensions (mm)						(Refer.) Mass (kg)	
$d$	$D$	$B_1$	$r$ min.	$r_1$ min.	$C_r$	$C_{0r}$	$C_r$	$C_{0r}$	$C_u$ (With machined cages)	$C_u$ (With pressed cages)		Grease lub.	Oil lub.	Back-to-back DB	Face-to-face DF	Tandem DT	$a_1$	$a_2$	$d_a$ min.	$d_b$ min.	$D_a$ max.	$D_b$ max.	$r_a$ max.	$r_b$ max.		
60	110	44	1.5	1	108	83.3	114	89.2	4.90	5.25	—	4 100	5 500	7212BDB	7212BDF	7212BDT	95.0	51.0	68.5	65.5	101.5	104.5	1.5	1	1.64	
	110	44	1.5	1	130	99.0	136	106	6.45	6.90	14.5	7 500	10 000	7212CDB	7212CDF	7212CDT	45.3	1.3	68.5	65.5	101.5	104.5	1.5	1	1.64	
	130	62	2.1	1.1	188	131	199	143	9.15	10.0	—	5 000	6 200	7312DB	7312DF	7312DT	86.5	24.5	72	67	118	123	2	1	3.62	
	130	62	2.1	1.1	172	121	183	132	7.90	8.60	—	3 700	5 000	7312BDB	7312BDF	7312BDT	111.6	49.6	72	67	118	123	2	1	3.62	
	130	62	2.1	1.1	201	141	213	153	10.5	11.4	13.4	6 800	9 100	7312CDB	7312CDF	7312CDT	56.7	5.3	72	67	118	123	2	1	3.62	
	150	70	2.1	1.1	262	187	—	—	13.7	—	—	3 200	4 600	7412DB	7412DF	7412DT	97.0	27.0	72	—	138	143	2	1	5.70	
	150	70	2.1	1.1	243	173	—	—	11.8	—	—	2 800	4 100	7412BDB	7412BDF	7412BDT	125.1	55.1	72	—	138	143	2	1	5.70	
	65	90	26	1	0.6	42.2	42.3	—	—	2.20	—	16.5	8 600	12 000	7913CDB	7913CDF	7913CDT	33.8	7.8	70.5	—	84.5	85.5	1	0.6	0.410
100		36	1.1	0.6	68.3	62.8	—	—	3.40	—	—	5 800	7 200	7013DB	7013DF	7013DT	65.9	29.9	72	—	93	95.5	1	0.6	0.940	
100		36	1.1	0.6	61.2	56.6	—	—	2.95	—	—	4 300	5 800	7013BDB	7013BDF	7013BDT	87.6	51.6	72	—	93	95.5	1	0.6	0.940	
100		36	1.1	0.6	75.2	68.7	—	—	3.85	—	15.9	7 900	11 000	7013CDB	7013CDF	7013CDT	40.2	4.2	72	—	93	95.5	1	0.6	0.940	
120		46	1.5	1	137	108	143	116	6.65	7.10	—	5 200	6 400	7213DB	7213DF	7213DT	76.4	30.4	73.5	70.5	111.5	114.5	1.5	1	2.04	
120		46	1.5	1	124	98.7	129	105	5.80	6.15	—	3 900	5 200	7213BDB	7213BDF	7213BDT	100.6	54.6	73.5	70.5	111.5	114.5	1.5	1	2.04	
120		46	1.5	1	148	117	155	125	7.60	8.10	14.6	7 100	9 400	7213CDB	7213CDF	7213CDT	47.8	1.8	73.5	70.5	111.5	114.5	1.5	1	2.04	
140		66	2.1	1.1	213	151	225	164	10.3	11.3	—	4 600	5 800	7313DB	7313DF	7313DT	92.5	26.5	77	72	128	133	2	1	4.44	
140		66	2.1	1.1	195	139	207	151	8.90	9.70	—	3 500	4 600	7313BDB	7313BDF	7313BDT	119.4	53.4	77	72	128	133	2	1	4.44	
140		66	2.1	1.1	228	161	242	176	11.8	12.9	13.4	6 300	8 500	7313CDB	7313CDF	7313CDT	60.6	5.4	77	72	128	133	2	1	4.44	
160		74	2.1	1.1	282	209	—	—	14.8	—	—	3 000	4 300	7413DB	7413DF	7413DT	102.9	28.9	77	—	148	153	2	1	6.82	
160		74	2.1	1.1	262	194	—	—	12.7	—	—	2 600	3 900	7413BDB	7413BDF	7413BDT	132.7	58.7	77	—	148	153	2	1	6.82	
70		100	32	1	0.6	58.8	58.0	—	—	3.05	—	16.4	7 800	11 000	7914CDB	7914CDF	7914CDT	38.8	6.8	75.5	—	94.5	95.5	1	0.6	0.664
		110	40	1.1	0.6	86.7	78.7	—	—	4.30	—	—	5 300	6 600	7014DB	7014DF	7014DT	72.0	32.0	77	—	103	105.5	1	0.6	1.32
	110	40	1.1	0.6	77.7	71.1	—	—	3.75	—	—	4 000	5 300	7014BDB	7014BDF	7014BDT	95.5	55.5	77	—	103	105.5	1	0.6	1.32	
	110	40	1.1	0.6	95.3	86.0	—	—	4.90	—	15.7	7 300	9 700	7014CDB	7014CDF	7014CDT	44.1	4.1	77	—	103	105.5	1	0.6	1.32	
	125	48	1.5	1	142	111	155	127	6.85	7.80	—	4 900	6 100	7214DB	7214DF	7214DT	80.3	32.3	78.5	75.5	116.5	119.5	1.5	1	2.24	
	125	48	1.5	1	128	101	140	116	5.90	6.75	—	3 700	4 900	7214BDB	7214BDF	7214BDT	105.8	57.8	78.5	75.5	116.5	119.5	1.5	1	2.24	
	125	48	1.5	1	154	120	168	138	7.75	8.90	14.6	6 700	8 900	7214CDB	7214CDF	7214CDT	50.1	2.1	78.5	75.5	116.5	119.5	1.5	1	2.24	
	150	70	2.1	1.1	239	172	253	187	11.4	12.4	—	4 300	5 400	7314DB	7314DF	7314DT	98.5	28.5	82	77	138	143	2	1	5.40	

[Notes] 1) Limiting speeds shown above are applicable to machined cage bearings. Limiting speeds of pressed cage bearings should be kept to under 80% of this value. For bearings with 15° contact angle, this figure is applied to the high precision bearings ranked higher than class 5, used with machined cages or molded cages.

2) B, C or no indication after the bearing number indicates nominal contact angle of 40°, 15° and 30° respectively. [Remark] Standard cage types used for the above bearings are described earlier in this section.

# Angular contact ball bearings (matched pair)

$d$  (70) ~ (80) mm



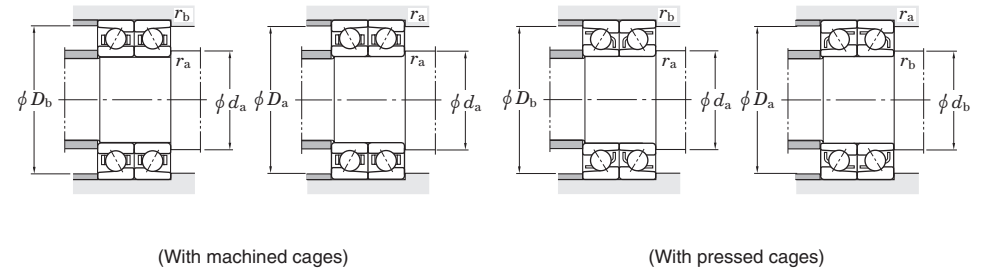
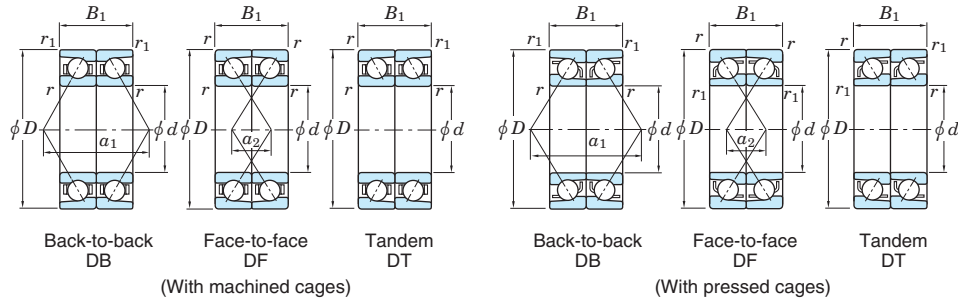
Boundary dimensions (mm)					Basic load ratings (kN)				Fatigue load limits (kN)		Factor	Limiting speeds <sup>1)</sup> (min <sup>-1</sup> )		Bearing No. <sup>2)</sup>			Load center spread (mm)		Mounting dimensions (mm)						(Refer.) Mass (kg)
$d$	$D$	$B_1$	$r$ min.	$r_1$ min.	$C_r$	$C_{0r}$	$C_r$	$C_{0r}$	$C_u$	$f_0$	Grease lub.	Oil lub.	Back-to-back DB	Face-to-face DF	Tandem DT	$a_1$	$a_2$	$d_a$ min.	$d_b$ min.	$D_a$ max.	$D_b$ max.	$r_a$ max.	$r_b$ max.		
70	150	70	2.1	1.1	219	158	232	172	9.80	10.7	—	3 200	4 300	7314BDB	7314BDF	7314BDT	127.3	57.3	82	77	138	143	2	1	5.40
	150	70	2.1	1.1	256	184	272	200	13.0	14.2	13.4	5 900	7 900	7314CDB	7314CDF	7314CDT	64.5	5.5	82	77	138	143	2	1	5.40
	180	84	3	1.1	303	230	—	—	10.6	—	—	2 700	3 900	7414DB	7414DF	7414DT	115.3	31.3	84	—	166	173	2.5	1	9.98
	180	84	3	1.1	301	237	—	—	10.9	—	—	2 300	3 500	7414BDB	7414BDF	7414BDT	148.4	64.4	84	—	166	173	2.5	1	9.98
75	105	32	1	0.6	59.7	60.9	—	—	3.15	—	16.5	7 400	9 800	7915CDB	7915CDF	7915CDT	40.1	8.1	80.5	—	99.5	100.5	1	0.6	0.700
	115	40	1.1	0.6	88.6	83.4	—	—	4.50	—	—	5 000	6 300	7015DB	7015DF	7015DT	74.9	34.9	82	—	108	110.5	1	0.6	1.38
	115	40	1.1	0.6	79.3	75.2	—	—	3.95	—	—	3 800	5 000	7015BDB	7015BDF	7015BDT	99.7	59.7	82	—	108	110.5	1	0.6	1.38
	115	40	1.1	0.6	97.6	91.3	—	—	5.10	—	15.9	6 900	9 200	7015CDB	7015CDF	7015CDT	45.5	5.5	82	—	108	110.5	1	0.6	1.38
	130	50	1.5	1	161	130	168	139	7.90	8.40	—	4 600	5 800	7215DB	7215DF	7215DT	84.2	34.2	83.5	80.5	121.5	124.5	1.5	1	2.46
	130	50	1.5	1	146	119	152	127	6.85	7.30	—	3 500	4 600	7215BDB	7215BDF	7215BDT	111.0	61.0	83.5	80.5	121.5	124.5	1.5	1	2.46
	130	50	1.5	1	175	141	183	151	8.95	9.55	14.6	6 400	8 500	7215CDB	7215CDF	7215CDT	52.5	2.5	83.5	80.5	121.5	124.5	1.5	1	2.46
	160	74	2.1	1.1	260	194	276	212	12.4	13.5	—	4 000	5 000	7315DB	7315DF	7315DT	104.9	30.9	87	82	148	153	2	1	6.30
	160	74	2.1	1.1	239	178	253	195	10.7	11.7	—	3 000	4 000	7315BDB	7315BDF	7315BDT	135.6	61.6	87	82	148	153	2	1	6.30
	160	74	2.1	1.1	279	208	296	227	14.2	15.5	13.4	5 500	7 400	7315CDB	7315CDF	7315CDT	68.5	5.5	87	82	148	153	2	1	6.30
	190	90	3	1.1	348	282	—	—	12.6	—	—	2 500	3 600	7415DB	7415DF	7415DT	122.7	32.7	89	—	176	183	2.5	1	11.8
	190	90	3	1.1	322	261	—	—	11.6	—	—	2 200	3 300	7415BDB	7415BDF	7415BDT	157.9	67.9	89	—	176	183	2.5	1	11.8
80	110	32	1	0.6	60.5	63.2	—	—	3.25	—	16.5	7 000	9 300	7916CDB	7916CDF	7916CDT	41.5	9.5	85.5	—	104.5	105.5	1	0.6	0.736
	125	44	1.1	0.6	108	101	—	—	5.50	—	—	4 600	5 800	7016DB	7016DF	7016DT	81.2	37.2	87	—	118	120.5	1	0.6	1.86
	125	44	1.1	0.6	97.1	91.3	—	—	4.75	—	—	3 500	4 600	7016BDB	7016BDF	7016BDT	108.0	64.0	87	—	118	120.5	1	0.6	1.86
	125	44	1.1	0.6	119	111	—	—	6.20	—	15.7	6 400	8 500	7016CDB	7016CDF	7016CDT	49.5	5.5	87	—	118	120.5	1	0.6	1.86
	140	52	2	1	173	143	181	152	8.25	8.80	—	4 300	5 400	7216DB	7216DF	7216DT	89.5	37.5	90	85.5	130	134.5	2	1	3.00
	140	52	2	1	157	130	163	139	7.15	7.60	—	3 200	4 300	7216BDB	7216BDF	7216BDT	118.3	66.3	90	85.5	130	134.5	2	1	3.00
	140	52	2	1	189	155	197	165	9.40	10.0	14.7	5 900	7 900	7216CDB	7216CDF	7216CDT	55.5	3.5	90	85.5	130	134.5	2	1	3.00
	170	78	2.1	1.1	282	218	299	238	13.5	14.7	—	3 800	4 700	7316DB	7316DF	7316DT	111.2	33.2	92	87	158	163	2	1	7.70
	170	78	2.1	1.1	259	200	274	218	11.6	12.7	—	2 800	3 800	7316BDB	7316BDF	7316BDT	143.9	65.9	92	87	158	163	2	1	7.70
	170	78	2.1	1.1	302	233	321	255	15.4	16.8	13.5	5 200	6 900	7316CDB	7316CDF	7316CDT	72.5	5.5	92	87	158	163	2	1	7.70
	200	96	3	1.1	391	332	—	—	14.4	—	—	2 400	3 400	7416DB	7416DF	7416DT	130.0	34.0	94	—	186	193	2.5	1	12.0

[Notes] 1) Limiting speeds shown above are applicable to machined cage bearings. Limiting speeds of pressed cage bearings should be kept to under 80% of this value. For bearings with 15° contact angle, this figure is applied to the high precision bearings ranked higher than class 5, used with machined cages or molded cages.

2) B, C or no indication after the bearing number indicates nominal contact angle of 40°, 15° and 30° respectively. [Remark] Standard cage types used for the above bearings are described earlier in this section.

Angular contact ball bearings (matched pair)

d (80) ~ (95) mm



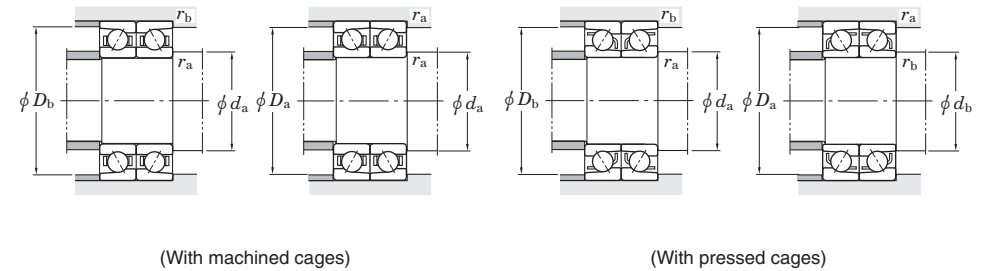
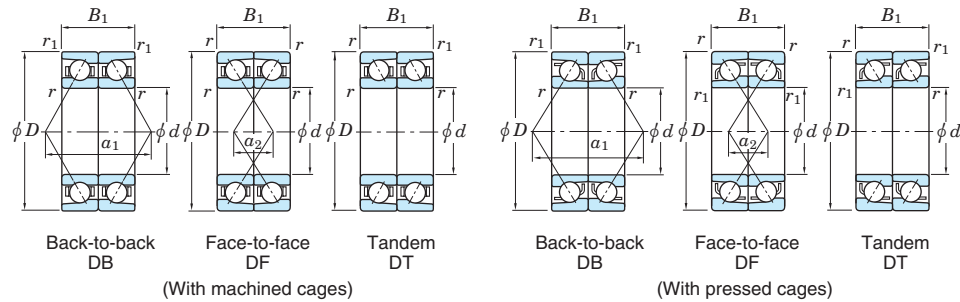
Boundary dimensions (mm)					Basic load ratings (kN)				Fatigue load limits (kN)		Factor	Limiting speeds <sup>1)</sup> (min <sup>-1</sup> )		Bearing No. <sup>2)</sup>			Load center spread (mm)		Mounting dimensions (mm)						(Refer.) Mass (kg)
d	D	B <sub>1</sub>	r min.	r <sub>1</sub> min.	C <sub>r</sub>	C <sub>0r</sub>	C <sub>r</sub>	C <sub>0r</sub>	C <sub>u</sub>	f <sub>0</sub>	Grease lub.	Oil lub.	Back-to-back DB	Face-to-face DF	Tandem DT	a <sub>1</sub>	a <sub>2</sub>	d <sub>a</sub> min.	d <sub>b</sub> min.	D <sub>a</sub> max.	D <sub>b</sub> max.	r <sub>a</sub> max.	r <sub>b</sub> max.		
<b>80</b>	200	96	3	1.1	363	307	—	—	13.3	—	—	2 100	3 100	<b>7416BDB</b>	<b>7416BDF</b>	<b>7416BDT</b>	167.2	71.2	94	—	186	193	2.5	1	12.0
<b>85</b>	120	36	1.1	0.6	79.0	81.3	—	—	4.20	—	16.5	6 500	8 600	<b>7917CDB</b>	<b>7917CDF</b>	<b>7917CDT</b>	45.5	9.5	92	—	113	115.5	1	0.6	1.05
	130	44	1.1	0.6	111	107	—	—	5.55	—	—	4 400	5 500	<b>7017DB</b>	<b>7017DF</b>	<b>7017DT</b>	84.7	40.7	92	—	123	125.5	1	0.6	1.94
	130	44	1.1	0.6	99.2	96.7	—	—	4.85	—	—	3 300	4 400	<b>7017BDB</b>	<b>7017BDF</b>	<b>7017BDT</b>	113.0	69.0	92	—	123	125.5	1	0.6	1.94
	130	44	1.1	0.6	122	117	—	—	6.30	—	15.9	6 000	8 000	<b>7017CDB</b>	<b>7017CDF</b>	<b>7017CDT</b>	51.1	7.1	92	—	123	125.5	1	0.6	1.94
	150	56	2	1	200	167	209	178	9.40	10.0	—	4 000	5 000	<b>7217DB</b>	<b>7217DF</b>	<b>7217DT</b>	95.9	39.9	95	90.5	140	144.5	2	1	3.74
	150	56	2	1	181	152	189	162	8.15	8.70	—	3 000	4 000	<b>7217BDB</b>	<b>7217BDF</b>	<b>7217BDT</b>	126.6	70.6	95	90.5	140	144.5	2	1	3.74
	150	56	2	1	218	181	227	193	10.7	11.4	14.7	5 500	7 400	<b>7217CDB</b>	<b>7217CDF</b>	<b>7217CDT</b>	59.5	3.5	95	90.5	140	144.5	2	1	3.74
	180	82	3	1.1	304	243	322	265	14.6	15.9	—	3 500	4 400	<b>7317DB</b>	<b>7317DF</b>	<b>7317DT</b>	117.5	35.5	99	92	166	173	2.5	1	9.06
	180	82	3	1.1	279	223	295	244	12.6	13.7	—	2 700	3 500	<b>7317BDB</b>	<b>7317BDF</b>	<b>7317BDT</b>	152.2	70.2	99	92	166	173	2.5	1	9.06
	180	82	3	1.1	326	261	346	284	16.7	18.2	13.5	4 900	6 500	<b>7317CDB</b>	<b>7317CDF</b>	<b>7317CDT</b>	76.5	5.5	99	92	166	173	2.5	1	9.06
	210	104	4	1.5	414	360	—	—	15.3	—	—	2 300	3 300	<b>7417DB</b>	<b>7417DF</b>	<b>7417DT</b>	137.5	33.5	103	—	192	201.5	3	1.5	17.1
	210	104	4	1.5	384	334	—	—	14.2	—	—	2 000	3 000	<b>7417BDB</b>	<b>7417BDF</b>	<b>7417BDT</b>	176.2	72.2	103	—	192	201.5	3	1.5	17.1
<b>90</b>	125	36	1.1	0.6	80.3	85.2	—	—	4.25	—	16.6	6 200	8 200	<b>7918CDB</b>	<b>7918CDF</b>	<b>7918CDT</b>	46.8	10.8	97	—	118	120.5	1	0.6	1.10
	140	48	1.5	1	132	127	—	—	6.45	—	—	4 100	5 100	<b>7018DB</b>	<b>7018DF</b>	<b>7018DT</b>	90.4	42.4	98.5	—	131.5	134.5	1.5	1	2.52
	140	48	1.5	1	119	114	—	—	5.60	—	—	3 100	4 100	<b>7018BDB</b>	<b>7018BDF</b>	<b>7018BDT</b>	120.5	72.5	98.5	—	131.5	134.5	1.5	1	2.52
	140	48	1.5	1	146	138	—	—	7.30	—	15.7	5 700	7 500	<b>7018CDB</b>	<b>7018CDF</b>	<b>7018CDT</b>	54.8	6.8	98.5	—	131.5	134.5	1.5	1	2.52
	160	60	2	1	229	193	239	206	10.6	11.3	—	3 800	4 700	<b>7218DB</b>	<b>7218DF</b>	<b>7218DT</b>	102.2	42.2	100	95.5	150	154.5	2	1	4.60
	160	60	2	1	207	176	217	188	9.15	9.80	—	2 800	3 800	<b>7218BDB</b>	<b>7218BDF</b>	<b>7218BDT</b>	134.9	74.9	100	95.5	150	154.5	2	1	4.60
	160	60	2	1	249	209	260	223	12.0	12.8	14.6	5 200	6 900	<b>7218CDB</b>	<b>7218CDF</b>	<b>7218CDT</b>	63.5	3.5	100	95.5	150	154.5	2	1	4.60
	190	86	3	1.1	327	270	346	294	11.8	12.8	—	3 300	4 200	<b>7318DB</b>	<b>7318DF</b>	<b>7318DT</b>	123.9	37.9	104	97	176	183	2.5	1	10.6
	190	86	3	1.1	300	248	317	270	10.8	11.8	—	2 500	3 300	<b>7318BDB</b>	<b>7318BDF</b>	<b>7318BDT</b>	160.5	74.5	104	97	176	183	2.5	1	10.6
	190	86	3	1.1	351	289	372	315	12.6	13.8	13.5	4 600	6 100	<b>7318CDB</b>	<b>7318CDF</b>	<b>7318CDT</b>	80.5	5.5	104	97	176	183	2.5	1	10.6
	225	108	4	1.5	439	393	—	—	16.2	—	—	2 100	3 100	<b>7418DB</b>	<b>7418DF</b>	<b>7418DT</b>	145.0	37.0	108	—	207	216.5	3	1.5	22.8
	225	108	4	1.5	406	364	—	—	15.0	—	—	1 800	2 800	<b>7418BDB</b>	<b>7418BDF</b>	<b>7418BDT</b>	186.2	78.2	108	—	207	216.5	3	1.5	22.8
<b>95</b>	130	36	1.1	0.6	81.6	88.3	—	—	4.30	—	16.5	5 900	7 900	<b>7919CDB</b>	<b>7919CDF</b>	<b>7919CDT</b>	48.1	12.1	102	—	123	125.5	1	0.6	1.15
	145	48	1.5	1	135	134	—	—	6.55	—	—	3 900	4 800	<b>7019DB</b>	<b>7019DF</b>	<b>7019DT</b>	94.5	46.5	103.5	—	136.5	139.5	1.5	1	2.64

[Notes] 1) Limiting speeds shown above are applicable to machined cage bearings. Limiting speeds of pressed cage bearings should be kept to under 80% of this value. For bearings with 15° contact angle, this figure is applied to the high precision bearings ranked higher than class 5, used with machined cages or molded cages.

2) B, C or no indication after the bearing number indicates nominal contact angle of 40°, 15° and 30° respectively. [Remark] Standard cage types used for the above bearings are described earlier in this section.

# Angular contact ball bearings (matched pair)

$d$  (95) ~ (105) mm



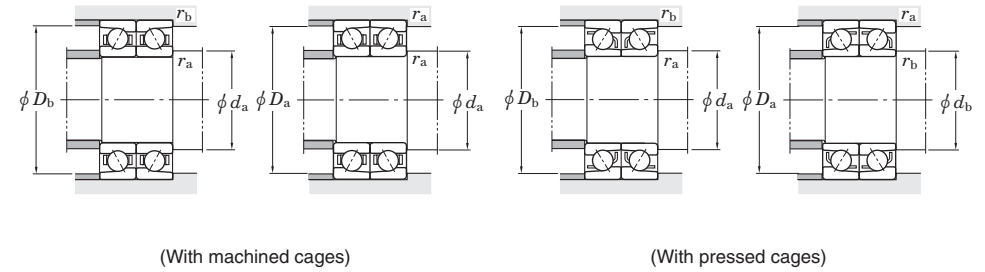
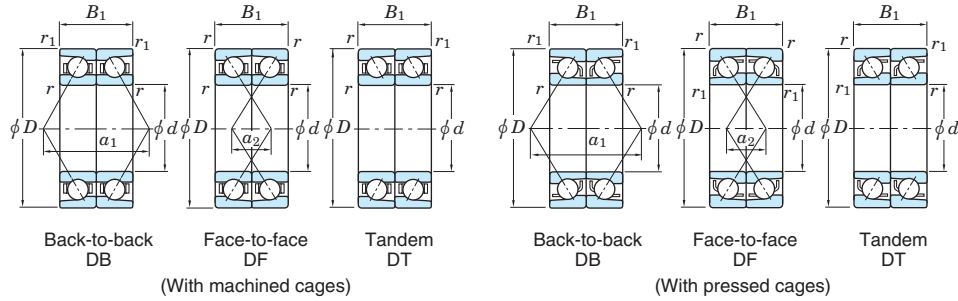
Boundary dimensions (mm)					Basic load ratings (kN)				Fatigue load limits (kN)		Factor $f_0$	Limiting speeds <sup>1)</sup> (min <sup>-1</sup> )		Bearing No. <sup>2)</sup>			Load center spread (mm)		Mounting dimensions (mm)						(Refer.) Mass (kg)	
$d$	$D$	$B_1$	$r$ min.	$r_1$ min.	$C_r$	$C_{0r}$	$C_r$	$C_{0r}$	$C_u$	$C_u$		Grease lub.	Oil lub.	Back-to-back DB	Face-to-face DF	Tandem DT	$a_1$	$a_2$	$d_a$ min.	$d_b$ min.	$D_a$ max.	$D_b$ max.	$r_a$ max.	$r_b$ max.		
95	145	48	1.5	1	121	121	—	—	5.70	—	—	2 900	3 900	7019BDB	7019BDF	7019BDT	126.4	78.4	103.5	—	136.5	139.5	1.5	1	2.64	
	145	48	1.5	1	149	147	—	—	7.40	—	15.9	5 300	7 100	7019CDB	7019CDF	7019CDT	56.7	8.7	103.5	—	136.5	139.5	1.5	1	2.64	
	170	64	2.1	1.1	248	207	260	221	11.0	11.8	—	3 500	4 400	7219DB	7219DF	7219DT	108.5	44.5	107	102	158	163	2	1	5.56	
	170	64	2.1	1.1	224	188	235	201	9.55	10.2	—	2 700	3 500	7219BDB	7219BDF	7219BDT	143.2	79.2	107	102	158	163	2	1	5.56	
	170	64	2.1	1.1	269	224	282	240	12.6	13.5	14.6	4 900	6 500	7219CDB	7219CDF	7219CDT	67.5	3.5	107	102	158	163	2	1	5.56	
	200	90	3	1.1	350	298	371	325	12.7	13.8	—	3 200	4 000	7319DB	7319DF	7319DT	130.2	40.2	109	102	186	193	2.5	1	12.2	
	200	90	3	1.1	321	273	340	298	11.6	12.7	—	2 400	3 200	7319BDB	7319BDF	7319BDT	168.8	78.8	109	102	186	193	2.5	1	12.2	
	200	90	3	1.1	376	319	398	348	13.6	14.8	13.5	4 400	5 800	7319CDB	7319CDF	7319CDT	84.5	5.5	109	102	186	193	2.5	1	12.2	
100	140	40	1.1	0.6	113	117	—	—	5.65	—	16.3	5 500	7 400	7920CDB	7920CDF	7920CDT	52.1	12.1	107	—	133	135.5	1	0.6	1.55	
	150	48	1.5	1	139	141	—	—	6.75	—	—	3 800	4 700	7020DB	7020DF	7020DT	96.2	48.2	108.5	—	141.5	144.5	1.5	1	2.74	
	150	48	1.5	1	124	127	—	—	5.90	—	—	2 800	3 800	7020BDB	7020BDF	7020BDT	128.9	80.9	108.5	—	141.5	144.5	1.5	1	2.74	
	150	48	1.5	1	153	154	—	—	7.65	—	16.0	5 200	6 900	7020CDB	7020CDF	7020CDT	57.5	9.5	108.5	—	141.5	144.5	1.5	1	2.74	
	180	68	2.1	1.1	279	235	292	252	12.2	13.0	—	3 300	4 100	7220DB	7220DF	7220DT	115.4	47.4	112	—	168	173	2	1	6.64	
	180	68	2.1	1.1	252	214	264	229	10.5	11.3	—	2 500	3 300	7220BDB	7220BDF	7220BDT	152.3	84.3	112	—	168	173	2	1	6.64	
	180	68	2.1	1.1	303	254	317	273	13.9	14.8	14.6	4 600	6 100	7220CDB	7220CDF	7220CDT	71.8	3.8	112	107	168	173	2	1	6.64	
	215	94	3	1.1	373	323	421	387	13.2	15.9	—	2 900	3 600	7320DB	7320DF	7320DT	138.8	44.8	114	—	201	208	2.5	1	15.1	
	215	94	3	1.1	342	297	386	356	12.2	14.6	—	2 200	2 900	7320BDB	7320BDF	7320BDT	180.4	86.4	114	—	201	208	2.5	1	15.1	
	215	94	3	1.1	400	346	451	415	14.2	17.0	13.4	4 000	5 300	7320CDB	7320CDF	7320CDT	89.6	4.4	114	107	201	208	2.5	1	15.1	
	105	145	40	1.1	0.6	115	123	—	—	5.75	—	16.4	5 300	7 100	7921CDB	7921CDF	7921CDT	53.5	13.5	112	—	138	140.5	1	0.6	1.62
		160	52	2	1	162	164	—	—	7.60	—	—	3 500	4 400	7021DB	7021DF	7021DT	103.7	51.7	115	—	150	154.5	2	1	3.46
160		52	2	1	145	148	—	—	6.65	—	—	2 600	3 500	7021BDB	7021BDF	7021BDT	137.2	85.2	115	—	150	154.5	2	1	3.46	
160		52	2	1	178	179	—	—	8.60	—	15.9	4 800	6 400	7021CDB	7021CDF	7021CDT	62.0	10.0	115	—	150	154.5	2	1	3.46	
190		72	2.1	1.1	303	265	—	—	13.4	—	—	3 100	3 900	7221DB	7221DF	7221DT	122.1	50.1	117	—	178	183	2	1	7.90	
190		72	2.1	1.1	275	241	—	—	11.6	—	—	2 300	3 100	7221BDB	7221BDF	7221BDT	161.0	89.0	117	—	178	183	2	1	7.90	
190		72	2.1	1.1	330	287	—	—	15.2	—	14.6	4 300	5 700	7221CDB	7221CDF	7221CDT	75.9	3.9	117	—	178	183	2	1	7.90	
225		98	3	1.1	422	386	—	—	15.5	—	—	2 800	3 500	7321DB	7321DF	7321DT	144.3	46.3	119	—	211	218	2.5	1	17.2	
225		98	3	1.1	387	355	—	—	14.3	—	—	2 100	2 800	7321BDB	7321BDF	7321BDT	187.5	89.5	119	—	211	218	2.5	1	17.2	

[Notes] 1) Limiting speeds shown above are applicable to machined cage bearings. Limiting speeds of pressed cage bearings should be kept to under 80% of this value. For bearings with 15° contact angle, this figure is applied to the high precision bearings ranked higher than class 5, used with machined cages or molded cages.

2) B, C or no indication after the bearing number indicates nominal contact angle of 40°, 15° and 30° respectively. [Remark] Standard cage types used for the above bearings are described earlier in this section.

Angular contact ball bearings (matched pair)

d (105) ~ (130) mm



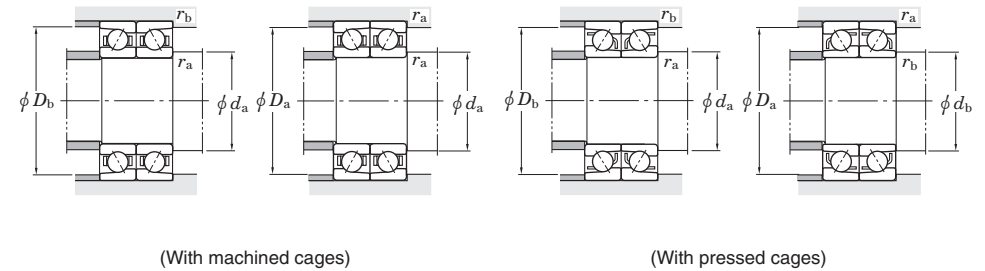
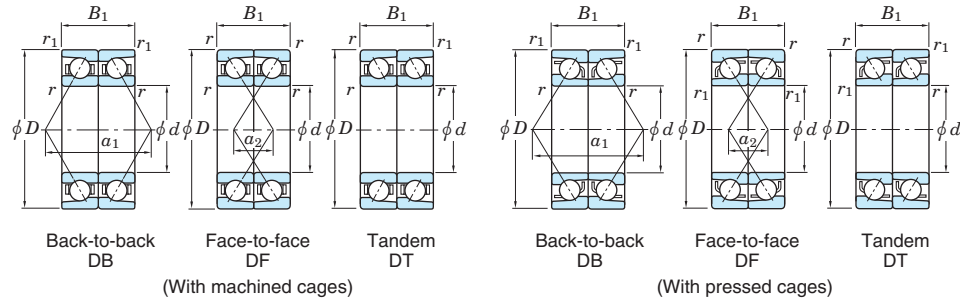
Boundary dimensions (mm)					Basic load ratings (kN)				Fatigue load limits (kN)		Factor $f_0$	Limiting speeds <sup>1)</sup> (min <sup>-1</sup> )		Bearing No. <sup>2)</sup>			Load center spread (mm)		Mounting dimensions (mm)						(Refer.) Mass (kg)	
d	D	B <sub>1</sub>	r min.	r <sub>1</sub> min.	C <sub>r</sub>	C <sub>0r</sub>	With pressed cages		C <sub>u</sub>	C <sub>u</sub>		Grease lub.	Oil lub.	Back-to-back DB	Face-to-face DF	Tandem DT	a <sub>1</sub>	a <sub>2</sub>	d <sub>a</sub> min.	d <sub>b</sub> min.	D <sub>a</sub> max.	D <sub>b</sub> max.	r <sub>a</sub> max.	r <sub>b</sub> max.		
105	225	98	3	1.1	452	413	—	—	16.6	—	13.4	3 900	5 100	7321CDB	7321CDF	7321CDT	93.2	4.8	119	—	211	218	2.5	1	17.2	
	110	150	40	1.1	0.6	117	129	—	—	5.85	—	16.5	5 100	6 800	7922CDB	7922CDF	7922CDT	54.8	14.8	117	—	143	145.5	1	0.6	1.68
		170	56	2	1	187	186	—	—	8.55	—	—	3 300	4 200	7022DB	7022DF	7022DT	108.9	52.9	120	—	160	164.5	2	1	4.28
		170	56	2	1	167	167	—	—	7.45	—	—	2 500	3 300	7022BDB	7022BDF	7022BDT	145.5	89.5	120	—	160	164.5	2	1	4.28
		170	56	2	1	205	203	—	—	9.70	—	15.7	4 600	6 100	7022CDB	7022CDF	7022CDT	65.5	9.5	120	—	160	164.5	2	1	4.28
		200	76	2.1	1.1	329	297	—	—	14.6	—	—	3 000	3 700	7222DB	7222DF	7222DT	128.7	52.7	122	—	188	193	2	1	9.30
		200	76	2.1	1.1	298	270	—	—	12.7	—	—	2 200	3 000	7222BDB	7222BDF	7222BDT	169.7	93.7	122	—	188	193	2	1	9.30
		200	76	2.1	1.1	357	321	—	—	16.7	—	14.5	4 100	5 400	7222CDB	7222CDF	7222CDT	80.1	4.1	122	—	188	193	2	1	9.30
240	100	3	1.1	472	452	—	—	17.5	—	—	2 600	3 200	7322DB	7322DF	7322DT	152.7	52.7	124	—	226	233	2.5	1	20.2		
240	100	3	1.1	433	416	—	—	16.1	—	—	1 900	2 600	7322BDB	7322BDF	7322BDT	199.3	99.3	124	—	226	233	2.5	1	20.2		
240	100	3	1.1	505	484	—	—	18.8	—	13.4	3 500	4 700	7322CDB	7322CDF	7322CDT	97.7	2.3	124	—	226	233	2.5	1	20.2		
120	165	44	1.1	0.6	146	162	—	—	7.10	—	16.5	4 700	6 200	7924CDB	7924CDF	7924CDT	60.2	16.2	127	—	158	160.5	1	0.6	2.30	
	180	56	2	1	196	206	—	—	9.00	—	—	3 100	3 900	7024DB	7024DF	7024DT	114.6	58.6	130	—	170	174.5	2	1	4.54	
	180	56	2	1	176	186	—	—	7.85	—	—	2 300	3 100	7024BDB	7024BDF	7024BDT	153.9	97.9	130	—	170	174.5	2	1	4.54	
	180	56	2	1	216	226	—	—	10.2	—	16.0	4 300	5 700	7024CDB	7024CDF	7024CDT	68.2	12.2	130	—	170	174.5	2	1	4.54	
	215	80	2.1	1.1	354	332	—	—	15.7	—	—	2 700	3 400	7224DB	7224DF	7224DT	137.0	57.0	132	—	203	208	2	1	11.0	
	215	80	2.1	1.1	321	302	—	—	13.6	—	—	2 100	2 800	7224BDB	7224BDF	7224BDT	180.5	100.5	132	—	203	208	2	1	11.0	
	215	80	2.1	1.1	385	359	—	—	17.9	—	14.6	3 800	5 000	7224CDB	7224CDF	7224CDT	85.0	5.0	132	—	203	208	2	1	11.0	
	260	110	3	1.1	500	504	—	—	18.9	—	—	2 400	3 000	7324DB	7324DF	7324DT	164.7	54.7	134	—	246	253	2.5	1	25.2	
	260	110	3	1.1	457	462	—	—	17.3	—	—	1 800	2 400	7324BDB	7324BDF	7324BDT	214.4	104.4	134	—	246	253	2.5	1	25.2	
	260	110	3	1.1	538	542	—	—	20.3	—	13.7	3 300	4 400	7324CDB	7324CDF	7324CDT	105.9	4.1	134	—	246	253	2.5	1	25.2	
130	180	48	1.5	1	177	200	—	—	8.45	—	16.4	4 300	5 700	7926CDB	7926CDF	7926CDT	65.5	17.5	138.5	—	171.5	174.5	1.5	1	3.00	
	200	66	2	1	238	251	—	—	10.5	—	—	2 800	3 500	7026DB	7026DF	7026DT	128.3	62.3	140	—	190	194.5	2	1	6.86	
	200	66	2	1	213	226	—	—	9.20	—	—	2 100	2 800	7026BDB	7026BDF	7026BDT	171.5	105.5	140	—	190	194.5	2	1	6.86	
	200	66	2	1	262	274	—	—	11.9	—	15.9	3 900	5 100	7026CDB	7026CDF	7026CDT	77.2	11.2	140	—	190	194.5	2	1	6.86	
	230	80	3	1.1	398	395	—	—	15.2	—	—	2 500	3 200	7226DB	7226DF	7226DT	143.9	63.9	144	—	216	223	2.5	1	12.4	

[Notes] 1) Limiting speeds shown above are applicable to machined cage bearings. Limiting speeds of pressed cage bearings should be kept to under 80% of this value. For bearings with 15° contact angle, this figure is applied to the high precision bearings ranked higher than class 5, used with machined cages or molded cages.

2) B, C or no indication after the bearing number indicates nominal contact angle of 40°, 15° and 30° respectively. [Remark] Standard cage types used for the above bearings are described earlier in this section.

### Angular contact ball bearings (matched pair)

$d$  (130) ~ (160) mm



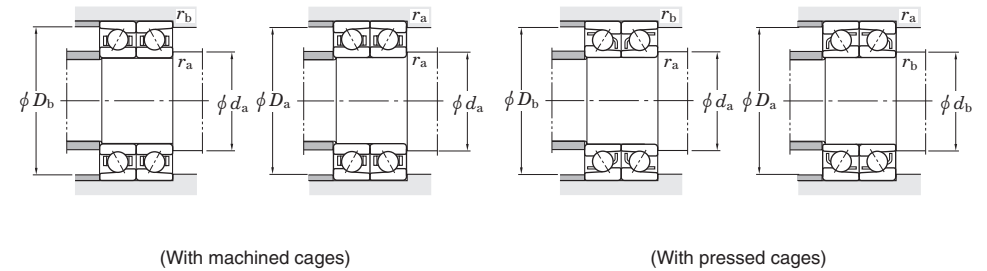
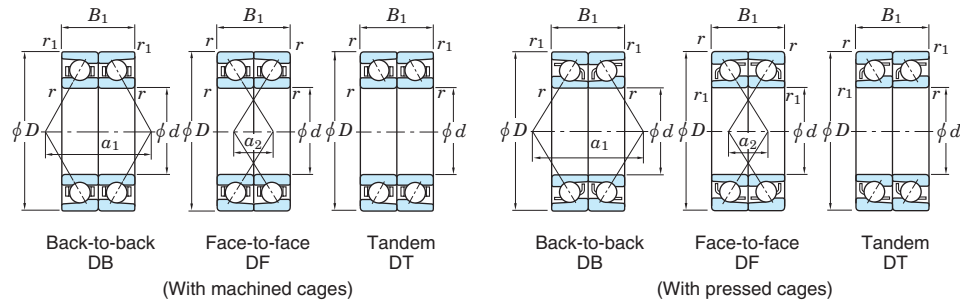
Boundary dimensions (mm)					Basic load ratings (kN)				Fatigue load limits (kN)		Factor $f_0$	Limiting speeds <sup>1)</sup> (min <sup>-1</sup> )		Bearing No. <sup>2)</sup>			Load center spread (mm)		Mounting dimensions (mm)						(Refer.) Mass (kg)
$d$	$D$	$B_1$	$r$ min.	$r_1$ min.	With machined cages		With pressed cages		$C_u$			Grease lub.	Oil lub.	Back-to-back DB	Face-to-face DF	Tandem DT	$a_1$	$a_2$	$d_a$ min.	$d_b$ min.	$D_a$ max.	$D_b$ max.	$r_a$ max.	$r_b$ max.	
130	230	80	3	1.1	360	360	—	—	13.9	—	1 900	2 500	7226BDB	7226BDF	7226BDT	191.0	111.0	144	—	216	223	2.5	1	12.4	
	230	80	3	1.1	433	428	—	—	16.5	—	3 500	4 700	7226CDB	7226CDF	7226CDT	88.2	8.2	144	—	216	223	2.5	1	12.4	
	280	116	4	1.5	611	659	—	—	23.7	—	2 200	2 700	7326DB	7326DF	7326DT	177.5	61.5	148	—	262	271.5	3	1.5	30.8	
	280	116	4	1.5	507	536	—	—	19.4	—	1 600	2 200	7326BDB	7326BDF	7326BDT	230.0	114.0	148	—	262	271.5	3	1.5	30.8	
	280	116	4	1.5	597	629	—	—	22.7	—	3 000	4 000	7326CDB	7326CDF	7326CDT	112.9	3.1	148	—	262	271.5	3	1.5	30.8	
	140	190	48	1.5	1	179	210	—	—	8.45	—	4 000	5 400	7928CDB	7928CDF	7928CDT	68.2	20.2	148.5	—	181.5	184.5	1.5	1	3.18
210		66	2	1	243	265	—	—	10.6	—	2 600	3 300	7028DB	7028DF	7028DT	134.1	68.1	150	—	200	204.5	2	1	7.28	
210		66	2	1	217	237	—	—	9.25	—	2 000	2 600	7028BDB	7028BDF	7028BDT	179.8	113.8	150	—	200	204.5	2	1	7.28	
210		66	2	1	268	290	—	—	12.0	—	3 600	4 800	7028CDB	7028CDF	7028CDT	79.9	13.9	150	—	200	204.5	2	1	7.28	
250		84	3	1.1	443	468	—	—	17.3	—	2 300	2 900	7228DB	7228DF	7228DT	154.6	70.6	154	—	236	243	2.5	1	15.5	
250		84	3	1.1	401	426	—	—	15.7	—	1 700	2 300	7228BDB	7228BDF	7228BDT	205.6	121.6	154	—	236	243	2.5	1	15.5	
250		84	3	1.1	483	508	—	—	18.8	—	3 200	4 300	7228CDB	7228CDF	7228CDT	94.2	10.2	154	—	236	243	2.5	1	15.5	
300		124	4	1.5	668	748	—	—	26.1	—	2 000	2 500	7328DB	7328DF	7328DT	189.0	65.0	158	—	282	291.5	3	1.5	37.6	
300		124	4	1.5	613	688	—	—	24.0	—	1 500	2 000	7328BDB	7328BDF	7328BDT	246.6	122.6	158	—	282	291.5	3	1.5	37.6	
300		124	4	1.5	717	802	—	—	27.9	—	2 800	3 700	7328CDB	7328CDF	7328CDT	120.9	3.1	158	—	282	291.5	3	1.5	37.6	
150		210	56	2	1	241	263	—	—	10.9	—	3 700	4 900	7930CDB	7930CDF	7930CDT	76.2	20.2	160	—	200	204.5	2	1	4.94
		225	70	2.1	1.1	278	308	—	—	11.9	—	2 400	3 000	7030DB	7030DF	7030DT	144.2	74.2	162	—	213	218	2	1	8.86
	225	70	2.1	1.1	249	275	—	—	10.4	—	1 800	2 400	7030BDB	7030BDF	7030BDT	192.3	122.3	162	—	213	218	2	1	8.86	
	225	70	2.1	1.1	306	337	—	—	13.4	—	3 300	4 400	7030CDB	7030CDF	7030CDT	85.6	15.6	162	—	213	218	2	1	8.86	
	270	90	3	1.1	504	560	—	—	19.9	—	2 100	2 700	7230DB	7230DF	7230DT	166.3	76.3	164	—	256	263	2.5	1	19.5	
	270	90	3	1.1	456	509	—	—	18.1	—	1 600	2 100	7230BDB	7230BDF	7230BDT	221.2	131.2	164	—	256	263	2.5	1	19.5	
	270	90	3	1.1	549	607	—	—	21.6	—	2 900	3 900	7230CDB	7230CDF	7230CDT	101.3	11.3	164	—	256	263	2.5	1	19.5	
	320	130	4	1.5	706	829	—	—	27.9	—	1 900	2 300	7330DB	7330DF	7330DT	200.7	70.7	168	—	302	311.5	3	1.5	44.8	
	320	130	4	1.5	645	760	—	—	25.6	—	1 400	1 900	7330BDB	7330BDF	7330BDT	262.2	132.2	168	—	302	311.5	3	1.5	44.8	
	320	130	4	1.5	760	891	—	—	30.0	—	2 600	3 400	7330CDB	7330CDF	7330CDT	128.0	2.0	168	—	302	311.5	3	1.5	44.8	
	160	220	56	2	1	245	289	—	—	10.9	—	3 500	4 700	7932CDB	7932CDF	7932CDT	78.9	22.9	170	—	210	214.5	2	1	5.20

[Notes] 1) Limiting speeds shown above are applicable to machined cage bearings. Limiting speeds of pressed cage bearings should be kept to under 80% of this value. For bearings with 15° contact angle, this figure is applied to the high precision bearings ranked higher than class 5, used with machined cages or molded cages.

2) B, C or no indication after the bearing number indicates nominal contact angle of 40°, 15° and 30° respectively. [Remark] Standard cage types used for the above bearings are described earlier in this section.

# Angular contact ball bearings (matched pair)

$d$  (160) ~ (180) mm



Boundary dimensions (mm)					Basic load ratings (kN)				Fatigue load limits (kN)		Factor	Limiting speeds <sup>1)</sup> (min <sup>-1</sup> )		Bearing No. <sup>2)</sup>			Load center spread (mm)		Mounting dimensions (mm)						(Refer.) Mass (kg)
$d$	$D$	$B_1$	$r$ min.	$r_1$ min.	$C_r$	$C_{0r}$	$C_r$	$C_{0r}$	$C_u$	$f_0$	Grease lub.	Oil lub.	Back-to-back DB	Face-to-face DF	Tandem DT	$a_1$	$a_2$	$d_a$ min.	$d_b$ min.	$D_a$ max.	$D_b$ max.	$r_a$ max.	$r_b$ max.		
160	240	76	2.1	1.1	315	353	—	—	13.3	—	2 300	2 800	7032DB	7032DF	7032DT	153.5	77.5	172	—	228	233	2	1	10.9	
	240	76	2.1	1.1	282	316	—	—	11.6	—	1 700	2 300	7032BDB	7032BDF	7032BDT	205.8	129.8	172	—	228	233	2	1	10.9	
	240	76	2.1	1.1	347	386	—	—	15.0	16.0	3 100	4 100	7032CDB	7032CDF	7032CDT	91.6	15.6	172	—	228	233	2	1	10.9	
	290	96	3	1.1	468	525	—	—	18.1	—	2 000	2 500	7232DB	7232DF	7232DT	177.9	81.9	174	—	276	283	2.5	1	24.2	
	290	96	3	1.1	482	557	—	—	19.2	—	1 500	2 000	7232BDB	7232BDF	7232BDT	236.8	140.8	174	—	276	283	2.5	1	24.2	
	290	96	3	1.1	511	665	—	—	19.7	—	2 700	3 600	7232CDB	7232CDF	7232CDT	108.3	12.3	174	—	276	283	2.5	1	24.2	
	340	136	4	1.5	741	909	—	—	29.7	—	1 700	2 200	7332DB	7332DF	7332DT	212.3	76.3	178	—	322	331.5	3	1.5	52.8	
	340	136	4	1.5	675	831	—	—	27.2	—	1 300	1 700	7332BDB	7332BDF	7332BDT	277.8	141.8	178	—	322	331.5	3	1.5	52.8	
	340	136	4	1.5	800	980	—	—	32.0	—	2 400	3 200	7332CDB	7332CDF	7332CDT	135.0	1.0	168.5	—	322	331.5	3	1.5	52.8	
	170	230	56	2	1	255	302	—	—	11.5	16.6	3 100	4 100	7934CDB	7934CDF	7934CDT	81.6	25.6	180	—	220	224.5	2	1	6.42
260		84	2.1	1.1	377	429	—	—	15.8	—	2 100	2 600	7034DB	7034DF	7034DT	166.2	82.2	182	—	248	253	2	1	15.2	
260		84	2.1	1.1	338	386	—	—	13.8	—	1 600	2 100	7034BDB	7034BDF	7034BDT	222.4	138.4	182	—	248	253	2	1	15.5	
260		84	2.1	1.1	415	469	—	—	17.9	15.9	2 900	3 800	7034CDB	7034CDF	7034CDT	99.6	15.6	182	—	248	253	2	1	15.1	
310		104	4	1.5	552	661	—	—	22.0	—	1 800	2 300	7234DB	7234DF	7234DT	190.6	86.6	188	—	292	301.5	3	1.5	30.2	
310		104	4	1.5	497	600	—	—	20.0	—	1 400	1 800	7234BDB	7234BDF	7234BDT	253.4	149.4	188	—	292	301.5	3	1.5	30.2	
310		104	4	1.5	603	719	—	—	24.0	15.1	2 500	3 300	7234CDB	7234CDF	7234CDT	116.3	12.3	188	—	292	301.5	3	1.5	30.2	
360		144	4	1.5	789	969	—	—	30.7	—	1 600	2 000	7334DB	7334DF	7334DT	225.0	81.0	188	—	342	351.5	3	1.5	62.4	
360		144	4	1.5	721	888	—	—	28.2	—	1 200	1 600	7334BDB	7334BDF	7334BDT	294.4	150.4	188	—	342	351.5	3	1.5	62.4	
360		144	4	1.5	849	1 040	—	—	33.1	13.8	2 200	3 000	7334CDB	7334CDF	7334CDT	143.0	1.0	188	—	342	351.5	3	1.5	62.4	
180	250	66	2	1	325	375	—	—	14.1	16.4	2 800	3 700	7936CDB	7936CDF	7936CDT	90.6	24.6	190	—	240	244.5	2	1	9.36	
	280	92	2.1	1.1	430	506	—	—	18.3	—	1 900	2 400	7036DB	7036DF	7036DT	178.8	86.8	192	—	268	273	2	1	20.2	
	280	92	2.1	1.1	385	457	—	—	15.9	—	1 400	1 900	7036BDB	7036BDF	7036BDT	239.0	147.0	192	—	268	273	2	1	20.4	
	280	92	2.1	1.1	473	553	—	—	20.7	15.7	2 600	3 500	7036CDB	7036CDF	7036CDT	107.6	15.6	192	—	268	273	2	1	19.9	
	320	104	4	1.5	596	724	—	—	23.7	—	1 700	2 200	7236DB	7236DF	7236DT	196.3	92.3	198	—	302	311.5	3	1.5	31.4	
	320	104	4	1.5	538	657	—	—	21.5	—	1 300	1 700	7236BDB	7236BDF	7236BDT	261.8	157.8	198	—	302	311.5	3	1.5	31.4	
	320	104	4	1.5	650	786	—	—	25.7	14.9	2 400	3 200	7236CDB	7236CDF	7236CDT	119.0	15.0	198	—	302	311.5	3	1.5	31.4	
	380	150	4	1.5	831	1 070	—	—	33.0	—	1 500	1 900	7336DB	7336DF	7336DT	236.7	86.7	198	—	362	371.5	3	1.5	80.0	

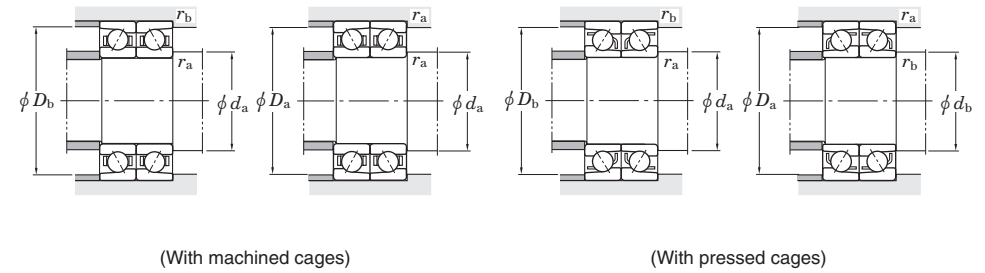
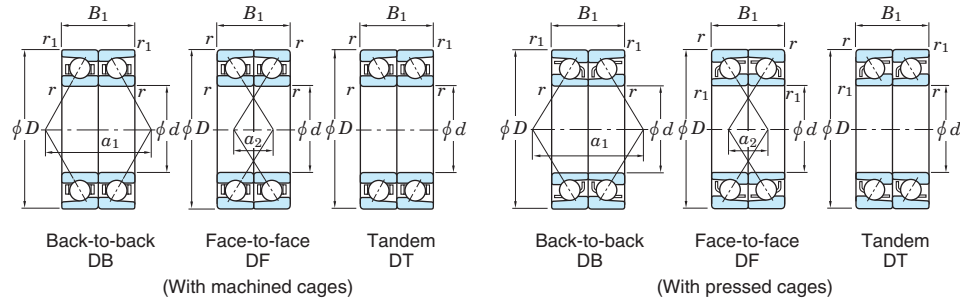
[Notes] 1) Limiting speeds shown above are applicable to machined cage bearings. Limiting speeds of pressed cage bearings should be kept to under 80% of this value. For bearings with 15° contact angle, this figure is applied to the high precision bearings ranked higher than class 5, used with machined cages or molded cages.

2) B, C or no indication after the bearing number indicates nominal contact angle of 40°, 15° and 30° respectively. [Remark] Standard cage types used for the above bearings are described earlier in this section.



# Angular contact ball bearings (matched pair)

$d$  (180) ~ 240 mm



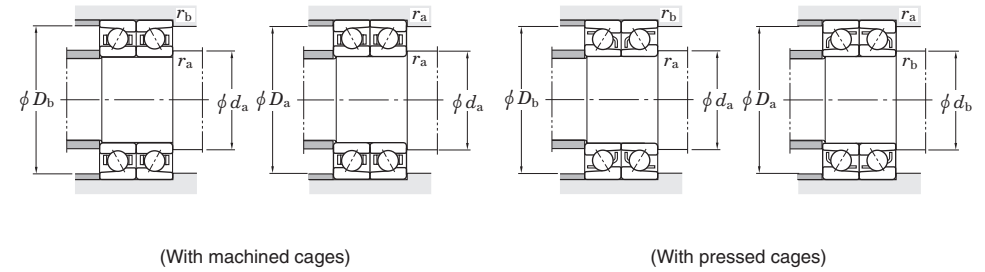
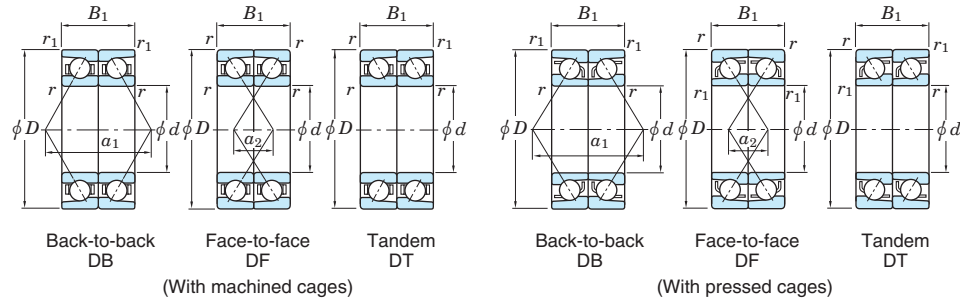
Boundary dimensions (mm)					Basic load ratings (kN)				Fatigue load limits (kN)		Factor $f_0$	Limiting speeds <sup>1)</sup> (min <sup>-1</sup> )		Bearing No. <sup>2)</sup>			Load center spread (mm)		Mounting dimensions (mm)						(Refer.) Mass (kg)	
$d$	$D$	$B_1$	$r$ min.	$r_1$ min.	With machined cages		With pressed cages		$C_u$	$C_{0r}$		$C_r$	$C_{0r}$	Grease lub.	Oil lub.	Back-to-back DB	Face-to-face DF	Tandem DT	$a_1$	$a_2$	$d_a$ min.	$d_b$ min.	$D_a$ max.	$D_b$ max.		$r_a$ max.
<b>180</b>	380	150	4	1.5	757	976	—	—	30.1	—	—	—	1 100	1 500	<b>7336BDB</b>	<b>7336BDF</b>	<b>7336BDT</b>	309.9	159.9	198	—	362	371.5	3	1.5	80.0
<b>190</b>	260	66	2	1	322	394	—	—	13.7	—	16.5	—	2 700	3 600	<b>7938CDB</b>	<b>7938CDF</b>	<b>7938CDT</b>	93.3	27.3	200	—	250	254.5	2	1	9.66
	290	92	2.1	1.1	441	535	—	—	18.7	—	—	—	1 800	2 300	<b>7038DB</b>	<b>7038DF</b>	<b>7038DT</b>	184.6	92.6	202	—	278	283	2	1	21.6
	290	92	2.1	1.1	395	483	—	—	16.3	—	—	—	1 400	1 800	<b>7038BDB</b>	<b>7038BDF</b>	<b>7038BDT</b>	247.4	155.4	202	—	278	283	2	1	21.6
	290	92	2.1	1.1	485	585	—	—	21.1	—	15.9	—	2 500	3 300	<b>7038CDB</b>	<b>7038CDF</b>	<b>7038CDT</b>	110.3	18.3	202	—	278	283	2	1	21.6
	340	110	4	1.5	616	779	—	—	24.7	—	—	—	1 600	2 000	<b>7238DB</b>	<b>7238DF</b>	<b>7238DT</b>	208.0	98.0	208	—	322	331.5	3	1.5	37.6
	340	110	4	1.5	555	706	—	—	22.4	—	—	—	1 200	1 600	<b>7238BDB</b>	<b>7238BDF</b>	<b>7238BDT</b>	277.4	167.4	208	—	322	331.5	3	1.5	37.6
	340	110	4	1.5	673	848	—	—	26.9	—	15.1	—	2 200	3 000	<b>7238CDB</b>	<b>7238CDF</b>	<b>7238CDT</b>	126.0	16.0	208	—	322	331.5	3	1.5	37.6
	400	156	5	2	914	1 200	—	—	36.0	—	—	—	1 400	1 800	<b>7338DB</b>	<b>7338DF</b>	<b>7338DT</b>	248.3	92.3	212	—	378	390	4	2	91.0
	400	156	5	2	835	1 100	—	—	33.0	—	—	—	1 100	1 400	<b>7338BDB</b>	<b>7338BDF</b>	<b>7338BDT</b>	325.5	169.5	212	—	378	390	4	2	91.0
<b>200</b>	280	76	2.1	1.1	415	509	—	—	17.4	—	16.3	—	2 500	3 300	<b>7940CDB</b>	<b>7940CDF</b>	<b>7940CDT</b>	102.3	26.3	212	—	268	273	2	1	13.7
	310	102	2.1	1.1	495	618	—	—	20.0	—	—	—	1 700	2 100	<b>7040DB</b>	<b>7040DF</b>	<b>7040DT</b>	198.3	96.3	212	—	298	303	2	1	25.4
	310	102	2.1	1.1	443	558	—	—	18.1	—	—	—	1 300	1 700	<b>7040BDB</b>	<b>7040BDF</b>	<b>7040BDT</b>	265.0	163.0	212	—	298	303	2	1	25.4
	310	102	2.1	1.1	544	676	—	—	21.9	—	15.7	—	2 300	3 100	<b>7040CDB</b>	<b>7040CDF</b>	<b>7040CDT</b>	119.3	17.3	212	—	298	303	2	1	25.4
	360	116	4	1.5	658	847	—	—	26.2	—	—	—	1 500	1 900	<b>7240DB</b>	<b>7240DF</b>	<b>7240DT</b>	219.7	103.7	218	—	342	351.5	3	1.5	44.8
	360	116	4	1.5	593	768	—	—	23.7	—	—	—	1 100	1 500	<b>7240BDB</b>	<b>7240BDF</b>	<b>7240BDT</b>	292.9	176.9	218	—	342	351.5	3	1.5	44.8
	360	116	4	1.5	718	921	—	—	28.4	—	15.1	—	2 100	2 800	<b>7240CDB</b>	<b>7240CDF</b>	<b>7240CDT</b>	133.0	17.0	218	—	342	351.5	3	1.5	44.8
	420	160	5	2	964	1 320	—	—	38.6	—	—	—	1 300	1 700	<b>7340DB</b>	<b>7340DF</b>	<b>7340DT</b>	259.0	99.0	222	—	398	410	4	2	104
	420	160	5	2	878	1 200	—	—	35.3	—	—	—	1 000	1 300	<b>7340BDB</b>	<b>7340BDF</b>	<b>7340BDT</b>	340.1	180.1	222	—	398	410	4	2	104
<b>220</b>	340	112	3	1.1	543	705	—	—	21.8	—	—	—	1 500	1 900	<b>7044DB</b>	<b>7044DF</b>	—	217.8	105.8	234	—	326	333	2.5	1	37.0
	340	112	3	1.1	486	636	—	—	19.6	—	—	—	1 100	1 500	<b>7044BDB</b>	<b>7044BDF</b>	—	290.9	178.9	234	—	326	333	2.5	1	37.8
<b>240</b>	360	112	3	1.1	591	751	—	—	24.6	—	—	—	1 400	1 700	<b>7048DB</b>	<b>7048DF</b>	—	229.2	117.2	254	—	346	353	2.5	1	39.4
	360	112	3	1.1	528	677	—	—	22.2	—	—	—	1 000	1 400	<b>7048BDB</b>	<b>7048BDF</b>	—	307.7	195.7	254	—	346	353	2.5	1	40.2
	440	144	4	1.5	819	1 190	—	—	33.4	—	—	—	1 200	1 500	<b>7248DB</b>	<b>7248DF</b>	—	268.3	124.3	258	—	422	431.5	3	1.5	104
	440	144	4	1.5	736	1 080	—	—	30.2	—	—	—	890	1 200	<b>7248BDB</b>	<b>7248BDF</b>	—	357.3	213.3	258	—	422	431.5	3	1.5	106

[Notes] 1) Limiting speeds shown above are applicable to machined cage bearings. Limiting speeds of pressed cage bearings should be kept to under 80% of this value. For bearings with 15° contact angle, this figure is applied to the high precision bearings ranked higher than class 5, used with machined cages or molded cages.

2) B, C or no indication after the bearing number indicates nominal contact angle of 40°, 15° and 30° respectively. [Remark] Standard cage types used for the above bearings are described earlier in this section.

Angular contact ball bearings (matched pair)

d 260 ~ 380 mm



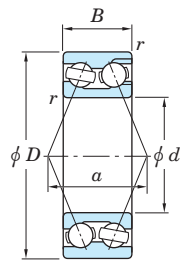
Boundary dimensions (mm)					Basic load ratings (kN)				Fatigue load limits (kN)		Factor $f_0$	Limiting speeds <sup>1)</sup> (min <sup>-1</sup> )		Bearing No. <sup>2)</sup>			Load center spread (mm)		Mounting dimensions (mm)						(Refer.) Mass (kg)
d	D	B <sub>1</sub>	r min.	r <sub>1</sub> min.	C <sub>r</sub>	C <sub>0r</sub>	C <sub>r</sub>	C <sub>0r</sub>	C <sub>u</sub>	C <sub>u</sub>		Grease lub.	Oil lub.	Back-to-back DB	Face-to-face DF	Tandem DT	a <sub>1</sub>	a <sub>2</sub>	d <sub>a</sub> min.	d <sub>b</sub> min.	D <sub>a</sub> max.	D <sub>b</sub> max.	r <sub>a</sub> max.	r <sub>b</sub> max.	
260	400	130	4	1.5	661	956	—	—	27.1	—	1 200	1 500	7052DB	7052DF	—	256.7	126.7	278	—	382	391.5	3	1.5	57.4	
	400	130	4	1.5	592	862	—	—	24.4	—	910	1 200	7052BDB	7052BDF	—	341.9	211.9	278	—	382	391.5	3	1.5	58.6	
280	420	130	4	1.5	675	1 010	—	—	27.9	—	1 100	1 400	7056DB	7056DF	—	267.1	137.1	298	—	402	411.5	3	1.5	60.8	
	420	130	4	1.5	623	906	—	—	26.2	—	850	1 100	7056BDB	7056BDF	—	358.7	228.7	298	—	402	411.5	3	1.5	62.0	
300	460	148	4	1.5	866	1 360	—	—	36.0	—	1 000	1 300	7060DB	7060DF	—	293.4	145.4	318	—	442	451.5	3	1.5	87.4	
	460	148	4	1.5	776	1 230	—	—	32.5	—	770	1 000	7060BDB	7060BDF	—	392.9	244.9	318	—	442	451.5	3	1.5	89.8	
320	480	148	4	1.5	887	1 440	—	—	37.3	—	950	1 200	7064DB	7064DF	—	304.9	156.9	338	—	462	471.5	3	1.5	92.0	
	480	148	4	1.5	795	1 300	—	—	33.6	—	710	950	7064BDB	7064BDF	—	409.6	261.6	338	—	462	471.5	3	1.5	94.4	
340	520	164	5	2	1 020	1 720	—	—	42.9	—	860	1 100	7068DB	7068DF	—	330.3	166.3	362	—	498	510	4	2	124	
	520	164	5	2	914	1 550	—	—	38.7	—	640	860	7068BDB	7068BDF	—	442.8	278.8	362	—	498	510	4	2	127	
360	540	164	5	2	1 050	1 830	—	—	44.5	—	800	1 000	7072DB	7072DF	—	341.8	177.8	382	—	518	530	4	2	129	
	540	164	5	2	937	1 650	—	—	40.1	—	600	800	7072BDB	7072BDF	—	459.6	295.6	382	—	518	530	4	2	132	
380	560	164	5	2	1 070	1 930	—	—	46.0	—	750	940	7076DB	7076DF	—	353.4	189.4	402	—	538	550	4	2	134	
	560	164	5	2	959	1 740	—	—	41.5	—	560	750	7076BDB	7076BDF	—	476.4	312.4	402	—	538	550	4	2	138	

[Notes] 1) Limiting speeds shown above are applicable to machined cage bearings. Limiting speeds of pressed cage bearings should be kept to under 80% of this value. For bearings with 15° contact angle, this figure is applied to the high precision bearings ranked higher than class 5, used with machined cages or molded cages.

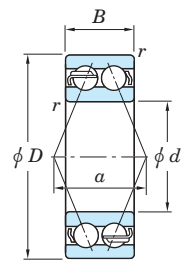
2) B or no indication after the bearing number indicates nominal contact angle of 40° and 30° respectively. [Remark] Standard cage types used for the above bearings are described earlier in this section.

# Double-row angular contact ball bearings

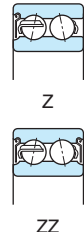
$d$  10 ~ (40) mm



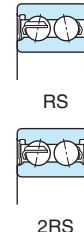
32, 33 series  
(With filling slot)



Open

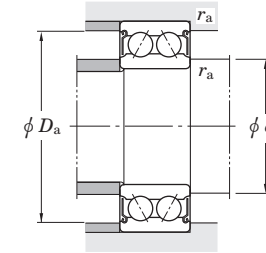
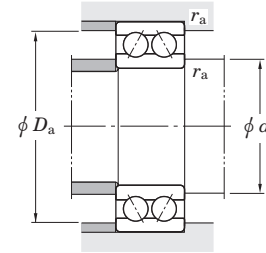


Shielded



Contact sealed

52, 53 series  
(Without filling slot)



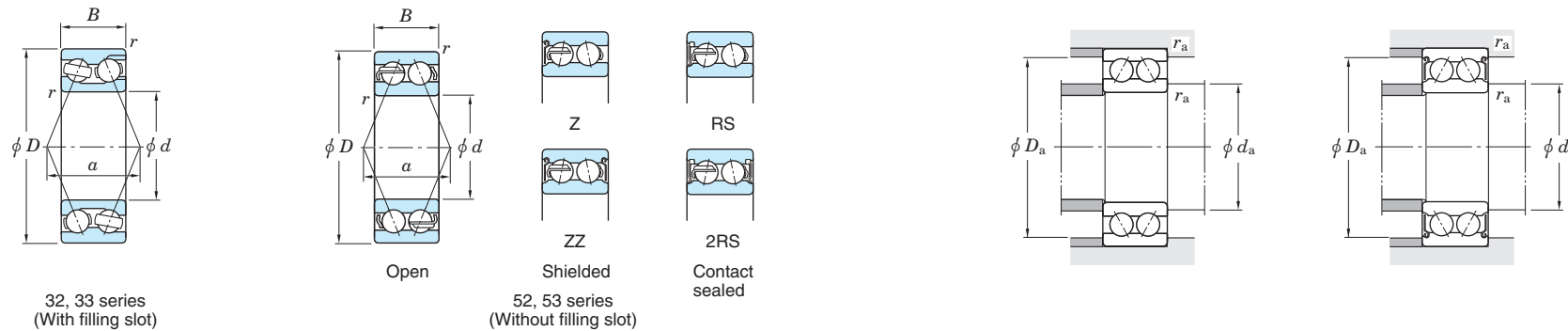
Boundary dimensions (mm)				Basic load ratings (kN)				Fatigue load limits (kN)		Limiting speeds (min <sup>-1</sup> )			Bearing No.			Load center spread (mm)	Mounting dimensions <sup>1)</sup> (mm)			(Refer.) Mass (kg)		
$d$	$D$	$B$	$r_{min.}$	Open		Shielded/sealed		$C_u$	Grease lub.	Oil lub.	Open	RS, 2RS	Sealed	Open	Shielded	Sealed	Open $a$	$d_a$			Mass	
				$C_r$	$C_{0r}$	$C_r$	$C_{0r}$											(Open)	(Shielded/sealed)	min.		max.
10	30	14.3	0.6	9.15	5.35	—	—	0.280	—	—	15 000	—	20 000	3200	—	—	19.5	14.5	—	25.5	0.6	0.052
12	32	15.9	0.6	12.1	7.15	—	—	0.370	—	—	14 000	—	18 000	3201	—	—	21.7	16.5	—	27.5	0.6	0.063
15	35	15.9	0.6	12.1	7.45	—	—	0.390	—	—	12 000	—	16 000	3202	—	—	23.6	19.5	—	30.5	0.6	0.072
	42	19	1	19.0	11.9	—	—	0.610	—	—	10 000	—	14 000	3302	—	—	27.6	20.5	—	36.5	1	0.132
17	40	17.5	0.6	17.2	10.8	—	—	0.560	—	—	11 000	—	14 000	3203	—	—	26.6	21.5	—	35.5	0.6	0.100
	40	17.5	0.6	16.5	8.15	15.9	8.35	0.420	0.430	11 000	11 000	14 000	5203 ZZ	5203 2RS	—	20.0	21.5	23.5	35.5	0.6	0.091	
	47	22.2	1	23.0	17.1	—	—	0.760	—	—	9 400	—	13 000	3303	—	—	31.0	22.5	—	41.5	1	0.192
20	47	20.6	1	21.5	15.0	—	—	0.770	—	—	9 000	—	12 000	3204	—	—	31.5	25.5	—	41.5	1	0.170
	47	20.6	1	24.6	12.5	20.0	10.8	0.640	0.560	8 800	8 800	12 000	5204	5204 ZZ	5204 2RS	23.5	25.5	26.6	41.5	1	0.158	
	52	22.2	1.1	26.0	18.4	—	—	0.950	—	—	8 200	—	11 000	3304	—	—	33.8	27	—	45	1	0.230
	52	22.2	1.1	30.9	15.0	24.7	12.8	0.780	0.660	8 300	8 300	11 000	5304	5304 ZZ	5304 2RS	25.9	27	28.3	45	1	0.230	
25	52	20.6	1	23.7	18.2	—	—	0.940	—	—	7 800	—	10 000	3205	—	—	34.4	30.5	—	46.5	1	0.190
	52	20.6	1	26.7	14.8	23.6	13.8	0.760	0.710	7 700	7 700	10 000	5205	5205 ZZ	5205 2RS	26.1	30.5	32.3	46.5	1	0.190	
	62	25.4	1.1	36.2	26.5	—	—	1.35	—	—	6 800	—	9 100	3305	—	—	40.5	32	—	55	1	0.369
	62	25.4	1.1	40.9	20.8	34.3	18.5	1.05	0.960	6 900	6 900	9 200	5305	5305 ZZ	5305 2RS	31.1	32	33.4	55	1	0.340	
30	62	23.8	1	34.1	27.0	—	—	1.40	—	—	6 500	—	8 700	3206	—	—	40.7	35.5	—	56.5	1	0.320
	62	23.8	1	37.2	21.3	31.7	18.3	1.10	0.950	6 400	6 400	8 600	5206	5206 ZZ	5206 2RS	30.8	35.5	38.6	56.5	1	0.290	
	72	30.2	1.1	47.7	36.1	—	—	1.85	—	—	5 800	—	7 800	3306	—	—	47.2	37	—	65	1	0.585
	72	30.2	1.1	51.2	28.5	42.9	25.2	1.45	1.30	5 800	5 800	7 700	5306	5306 ZZ	5306 2RS	36.2	37	41.3	65	1	0.510	
35	72	27	1.1	46.0	37.5	—	—	1.95	—	—	5 600	—	7 500	3207	—	—	46.9	42	—	65	1	0.480
	72	27	1.1	49.0	29.0	39.7	24.6	1.50	1.25	5 500	5 500	7 300	5207	5207 ZZ	5207 2RS	36.1	42	43.9	65	1	0.430	
	80	34.9	1.5	60.7	46.8	—	—	2.40	—	—	5 200	—	7 000	3307	—	—	53.4	43.5	—	71.5	1.5	0.816
	80	34.9	1.5	64.0	36.2	57.6	32.8	1.85	1.70	5 100	5 100	6 800	5307	5307 ZZ	5307 2RS	41.0	43.5	45.5	71.5	1.5	0.790	
40	80	30.2	1.1	52.4	43.9	—	—	2.25	—	—	5 000	—	6 700	3208	—	—	52.6	47	—	73	1	0.650
	80	30.2	1.1	55.5	33.6	45.7	29.1	1.75	1.50	5 000	5 000	6 700	5208	5208 ZZ	5208 2RS	39.2	47	49.5	73	1	0.570	

[Note] 1) The maximum value of  $d_a$  is applied to shielded and sealed type bearings.

[Remark] Standard cage types used for the above bearings are described earlier in this section.

# Double-row angular contact ball bearings

$d$  (40) ~ 70 mm



32, 33 series  
(With filling slot)

52, 53 series  
(Without filling slot)

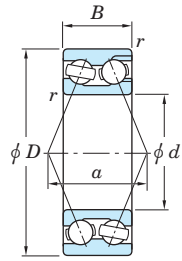
Boundary dimensions (mm)				Basic load ratings (kN)				Fatigue load limits (kN)		Limiting speeds (min <sup>-1</sup> )			Bearing No.			Load center spread (mm)	Mounting dimensions <sup>1)</sup> (mm)			(Refer.) Mass (kg)	
$d$	$D$	$B$	$r_{min.}$	Open		Shielded/sealed		$C_u$		Grease lub. Oil lub.			Open	Shielded	Sealed	Open $a$	$d_a$			Mass	
				$C_r$	$C_{0r}$	$C_r$	$C_{0r}$	(Open)	(Shielded/sealed)	[Open Z, ZZ]	(RS, 2RS)	[Open Z]					min.	max.	$D_a$ max.		$r_a$ max.
40	90	36.5	1.5	67.6	53.8	—	—	2.80	—	4 600	—	6 100	3308	—	—	58.9	48.5	—	81.5	1.5	1.07
	90	36.5	1.5	78.3	45.4	64.3	37.8	2.35	1.95	4 600	4 600	6 100	5308	5308 ZZ	5308 2RS	44.9	48.5	52.1	81.5	1.5	1.05
45	85	30.2	1.1	56.8	51.4	—	—	2.65	—	4 600	—	6 100	3209	—	—	56.3	52	—	78	1	0.710
	85	30.2	1.1	62.3	38.4	52.1	33.9	2.00	1.75	4 600	4 600	6 100	5209	5209 ZZ	5209 2RS	42.2	52	55.3	78	1	0.620
	100	39.7	1.5	82.6	67.3	—	—	3.50	—	4 100	—	5 500	3309	—	—	65.6	53.5	—	91.5	1.5	1.42
	100	39.7	1.5	93.8	55.7	86.1	51.4	2.90	2.65	4 100	4 100	5 500	5309	5309 ZZ	5309 2RS	51.0	53.5	58.2	91.5	1.5	1.42
50	90	30.2	1.1	56.4	52.1	—	—	2.70	—	4 300	—	5 700	3210	—	—	58.8	57	—	83	1	0.760
	90	30.2	1.1	66.7	43.6	55.2	37.9	2.25	1.95	4 300	4 300	5 600	5210	5210 ZZ	5210 2RS	44.5	57	58.9	83	1	0.670
	110	44.4	2	108	88.6	—	—	4.60	—	3 800	—	5 000	3310	—	—	71.7	60	—	100	2	1.95
	110	44.4	2	111	67.0	102	62.2	3.45	3.20	3 600	3 600	4 800	5310	5310 ZZ	5310 2RS	56.6	60	64.4	100	2	1.93
55	100	33.3	1.5	63.6	60.2	—	—	3.10	—	3 900	—	5 100	3211	—	—	65.0	63.5	—	91.5	1.5	1.05
	100	33.3	1.5	82.3	55.2	66.1	44.7	2.85	2.30	3 800	3 800	5 100	5211	5211 ZZ	5211 2RS	50.2	63.5	66.2	91.5	1.5	0.960
	120	49.2	2	126	106	—	—	5.45	—	3 400	—	4 500	3311	—	—	79.3	65	—	110	2	2.53
	120	49.2	2	138	85.1	120	74.3	4.40	3.85	3 300	3 300	4 500	5311	5311 ZZ	5311 2RS	61.6	65	71.8	110	2	2.30
60	110	36.5	1.5	80.0	76.8	—	—	3.95	—	3 500	—	4 700	3212	—	—	71.3	68.5	—	101.5	1.5	1.40
	110	36.5	1.5	93.0	60.8	78.3	55.9	3.15	2.90	3 500	3 500	4 700	5212	5212 ZZ	5212 2RS	53.8	68.5	74.1	101.5	1.5	1.36
	130	54	2.1	156	132	—	—	6.85	—	3 100	—	4 200	3312	—	—	87.4	72	—	118	2	3.24
	130	54	2.1	157	98.7	138	87.1	5.10	4.50	3 100	3 100	4 100	5312	5312 ZZ	5312 2RS	67.2	72	79.2	118	2	3.16
65	120	38.1	1.5	95.5	97.4	—	—	5.05	—	3 200	—	4 300	3213	—	—	76.8	73.5	—	111.5	1.5	1.75
	120	38.1	1.5	109	75.3	86.5	63.1	3.90	3.25	3 200	3 200	4 300	5213	5213 ZZ	5213 2RS	58.8	73.5	79.0	111.5	1.5	1.66
	140	58.7	2.1	177	153	—	—	7.80	—	2 900	—	3 900	3313	—	—	92.7	77	—	128	2	4.08
	140	58.7	2.1	178	113	178	113	5.75	5.75	2 900	2 900	3 900	5313	5313 ZZ	5313 2RS	70.9	77	85.9	128	2	3.91
70	125	39.7	1.5	97.4	96.4	—	—	5.00	—	3 100	—	4 100	3214	—	—	80.7	78.5	—	116.5	1.5	1.92
	125	39.7	1.5	118	82.6	95.4	70.3	4.25	3.65	3 100	3 100	4 100	5214	5214 ZZ	5214 2RS	61.4	78.5	83.5	116.5	1.5	1.81
	150	63.5	2.1	188	160	—	—	7.90	—	2 700	—	3 600	3314	—	—	99.7	82	—	138	2	5.04
	150	63.5	2.1	200	129	200	129	6.35	6.35	2 700	2 700	3 600	5314	5314 ZZ	5314 2RS	76.0	82	92.9	138	2	4.89

[Note] 1) The maximum value of  $d_a$  is applied to shielded and sealed type bearings.

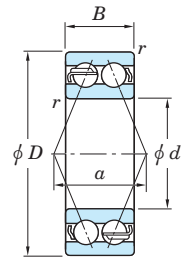
[Remark] Standard cage types used for the above bearings are described earlier in this section.

# Double-row angular contact ball bearings

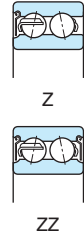
$d$  75 ~ 110 mm



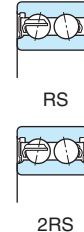
32, 33 series  
(With filling slot)



Open

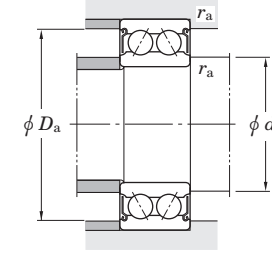
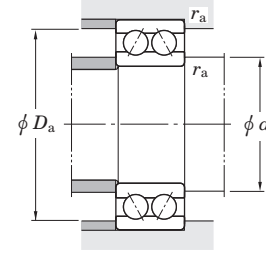


Shielded



Contact sealed

52, 53 series  
(Without filling slot)



Boundary dimensions (mm)				Basic load ratings (kN)				Fatigue load limits (kN)		Limiting speeds (min <sup>-1</sup> )			Bearing No.			Load center spread (mm)	Mounting dimensions <sup>1)</sup> (mm)			(Refer.) Mass (kg)	
$d$	$D$	$B$	$r_{min.}$	Open		Shielded/sealed		$C_u$		Grease lub.		Oil lub.		Open	Shielded	Sealed	Open $a$	$d_a$			Mass
				$C_r$	$C_{0r}$	$C_r$	$C_{0r}$	(Open)	(Shielded/sealed)	[Open] Z, ZZ	(RS, 2RS)	[Open] Z	min.					max.	$D_a$ max.	$r_a$ max.	
75	130	41.3	1.5	116	120	—	—	6.15	—	2 900	—	3 900	3215	—	—	84.7	83.5	—	121.5	1.5	2.10
	160	68.3	2.1	211	189	—	—	9.00	—	2 500	—	3 300	3315	—	—	108.7	87	—	148	2	6.16
	160	68.3	2.1	218	147	218	147	6.95	6.95	2 500	2 500	3 300	5315	5315 ZZ	5315 2RS	81.5	87	99.6	148	2	5.97
80	140	44.4	2	122	121	—	—	5.95	—	2 700	—	3 600	3216	—	—	90.7	90	—	130	2	2.64
	170	68.3	2.1	230	213	—	—	9.85	—	2 400	—	3 100	3316	—	—	113.1	92	—	158	2	6.93
85	150	49.2	2	143	143	—	—	6.80	—	2 500	—	3 400	3217	—	—	98.4	95	—	140	2	3.39
	180	73	3	235	219	—	—	9.80	—	2 200	—	3 000	3317	—	—	118.8	99	—	166	2.5	8.30
90	160	52.4	2	165	167	—	—	7.70	—	2 400	—	3 100	3218	—	—	104.1	100	—	150	2	4.14
	190	73	3	256	242	—	—	10.6	—	2 100	—	2 800	3318	—	—	125.5	104	—	176	2.5	9.23
95	170	55.6	2.1	189	193	—	—	8.65	—	2 200	—	3 000	3219	—	—	110.6	107	—	158	2	5.00
	200	77.8	3	273	270	—	—	14.9	—	2 000	—	2 600	3319	—	—	132.2	109	—	186	2.5	10.9
100	180	60.3	2.1	215	221	—	—	9.65	—	2 100	—	2 800	3220	—	—	116.8	112	—	168	2	6.10
	215	82.6	3	312	324	—	—	17.4	—	1 800	—	2 500	3320	—	—	140.4	114	—	201	2.5	13.5
105	190	65.1	2.1	227	237	—	—	11.5	—	2 000	—	2 600	3221	—	—	124.2	117	—	178	2	7.37
	225	87.3	3	331	354	—	—	18.5	—	1 800	—	2 300	3321	—	—	148.1	119	—	211	2.5	15.6
110	200	69.8	2.1	251	263	—	—	10.9	—	1 900	—	2 500	3222	—	—	131.4	122	—	188	2	8.80
	240	92.1	3	352	388	—	—	15.1	—	1 600	—	2 200	3322	—	—	156.4	124	—	226	2.5	18.9

[Note] 1) The maximum value of  $d_a$  is applied to shielded and sealed type bearings.

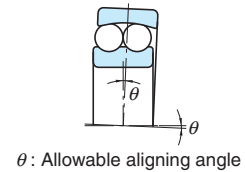
[Remark] Standard cage types used for the above bearings are described earlier in this section.

## Self-aligning ball bearings

Self-aligning ball bearings have a spherical outer ring raceway, the center of whose curvature meets that of the bearing itself, so that the inner ring, balls and cage continue to rotate, aligning themselves if they have become misaligned within design limits.

This type of bearing is suitable when the displacement of the centers around which the shaft and housing rotate and shaft deflection are likely to occur.

Bearings with a tapered bore can easily be fit to the shaft with an adapter assembly.



### Self-aligning ball bearings



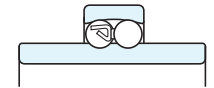
Cylindrical bore    Tapered bore

Bore diameter **10 – 90 mm**



Sealed type

Bore diameter **10 – 55 mm**



Extended inner ring type

Bore diameter **20 – 60 mm**

### Adapter assemblies



Bore diameter **17 – 80 mm**

Boundary dimensions	The dimensions of standard series are as specified in JIS B 1512.
Tolerances	As specified in JIS B 1514-1, class 0. (refer to Table 7-3 on pp. A 60 – A 63.)
Radial internal clearance	As specified in JIS B 1520. (refer to Table 10-6 on p. A 105.)
Recommended fits	Refer to Table 9-4 on pp. A 91, 92.
Standard cages	<ul style="list-style-type: none"> <li>• Staggered type pressed steel cage (application : all dimensional range of 12, 13, 112, 113, 22...2RS and 23...2RS series)</li> <li>• Snap type pressed steel cage (application : all dimensional range of 22 series and those of No. 2300 thru 2316.)</li> <li>• Copper alloy machined cage (application : bearings of No. 2317 thru 2322)</li> </ul>
Allowable aligning angle	<ul style="list-style-type: none"> <li>• 12 and 22 series .....0.044 rad (2.5°)</li> <li>• 13 and 23 series .....0.052 rad (3°)</li> <li>• 22...2RS and 23...2RS series .....0.026 rad (1.5°)</li> </ul>

Dynamic equivalent radial load

$$P_r = X F_r + Y F_a$$

$F_a / F_r \leq e$		$F_a / F_r > e$	
X	Y	X	Y
1	$Y_1$	0.65	$Y_2$

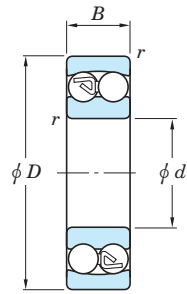
Static equivalent radial load

$$P_{0r} = F_r + Y_0 F_a$$

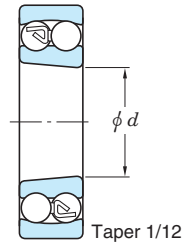
Refer to the bearing specification table for values of  $e$ ,  $Y_1$ ,  $Y_2$  and  $Y_0$ .

# Self-aligning ball bearings open type

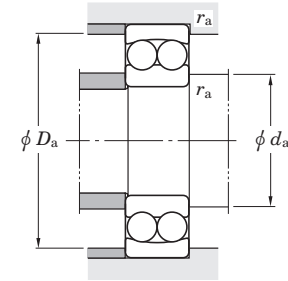
$d$  10 ~ (35) mm



Cylindrical bore



Tapered bore

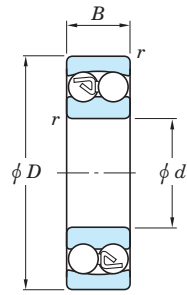


Boundary dimensions (mm)				Basic load ratings (kN)		Fatigue load limit (kN)	Limiting speeds (min <sup>-1</sup> )		Bearing No.		Mounting dimensions (mm)			Con-stant	Axial load factors			(Refer.) Mass (kg)	
$d$	$D$	$B$	$r_{min.}$	$C_r$	$C_{0r}$	$C_u$	Grease lub.	Oil lub.	Cylindrical bore	Tapered bore	$d_a$ min.	$D_a$ max.	$r_a$ max.	$e$	$Y_1$	$Y_2$	$Y_0$	Cylindrical bore	Tapered bore
10	30	9	0.6	5.50	1.20	0.08	23 000	28 000	1200	—	14	26	0.6	0.33	1.92	2.97	2.01	0.034	—
	30	14	0.6	7.40	1.60	0.10	23 000	29 000	2200	—	14	26	0.6	0.59	1.07	1.65	1.12	0.047	—
12	32	10	0.6	5.60	1.25	0.08	21 000	26 000	1201	—	16	28	0.6	0.33	1.89	2.93	1.98	0.040	—
	32	14	0.6	7.65	1.75	0.11	21 000	26 000	2201	—	16	28	0.6	0.53	1.18	1.83	1.24	0.053	—
15	35	11	0.6	7.45	1.75	0.11	18 000	22 000	1202	—	19	31	0.6	0.33	1.90	2.95	2.00	0.049	—
	35	14	0.6	7.70	1.85	0.12	18 000	22 000	2202	—	19	31	0.6	0.50	1.27	1.97	1.33	0.060	—
	42	13	1	9.55	2.30	0.14	16 000	20 000	1302	—	20	37	1	0.34	1.86	2.88	1.95	0.094	—
	42	17	1	12.1	2.90	0.18	14 000	20 000	2302	—	20	37	1	0.50	1.27	1.96	1.33	0.114	—
17	40	12	0.6	7.90	2.05	0.13	16 000	20 000	1203	—	21	36	0.6	0.31	2.03	3.14	2.12	0.073	—
	40	16	0.6	9.80	2.40	0.15	16 000	20 000	2203	—	21	36	0.6	0.50	1.27	1.96	1.33	0.088	—
	47	14	1	12.5	3.20	0.20	14 000	17 000	1303	—	22	42	1	0.33	1.92	2.97	2.01	0.130	—
	47	19	1	14.5	3.60	0.23	13 000	18 000	2303	—	22	42	1	0.49	1.28	1.98	1.34	0.158	—
20	47	14	1	9.90	2.65	0.16	14 000	17 000	1204	1204K	25	42	1	0.29	2.16	3.35	2.27	0.120	0.118
	47	18	1	12.6	3.25	0.21	14 000	17 000	2204	2204K	25	42	1	0.48	1.31	2.02	1.37	0.140	0.136
	52	15	1.1	12.4	3.35	0.21	13 000	15 000	1304	1304K	26.5	45.5	1	0.30	2.12	3.28	2.22	0.163	0.161
	52	21	1.1	18.0	4.65	0.30	11 000	15 000	2304	2304K	26.5	45.5	1	0.49	1.29	2.00	1.35	0.209	0.205
25	52	15	1	12.1	3.30	0.21	12 000	14 000	1205	1205K	30	47	1	0.28	2.28	3.52	2.39	0.141	0.138
	52	18	1	12.6	3.50	0.22	12 000	15 000	2205	2205K	30	47	1	0.40	1.58	2.45	1.66	0.163	0.158
	62	17	1.1	18.0	5.05	0.32	9 900	12 000	1305	1305K	31.5	55.5	1	0.27	2.31	3.57	2.42	0.257	0.252
	62	24	1.1	24.5	6.55	0.42	9 400	13 000	2305	2305K	31.5	55.5	1	0.46	1.36	2.10	1.42	0.335	0.327
30	62	16	1	15.6	4.70	0.29	9 900	12 000	1206	1206K	35	57	1	0.25	2.55	3.94	2.67	0.220	0.216
	62	20	1	15.5	4.65	0.29	10 000	12 000	2206	2206K	35	57	1	0.35	1.79	2.77	1.87	0.260	0.254
	72	19	1.1	21.3	6.30	0.40	8 700	11 000	1306	1306K	36.5	65.5	1	0.26	2.40	3.72	2.52	0.387	0.381
	72	27	1.1	31.5	8.70	0.55	8 000	11 000	2306	2306K	36.5	65.5	1	0.44	1.44	2.23	1.51	0.500	0.489
35	72	17	1.1	15.8	5.15	0.32	8 500	10 000	1207	1207K	41.5	65.5	1	0.23	2.71	4.20	2.84	0.323	0.317

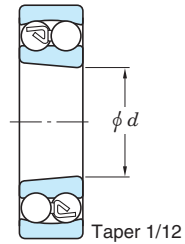
[Remark] Standard cage types used for the above bearings are described earlier in this section.

# Self-aligning ball bearings open type

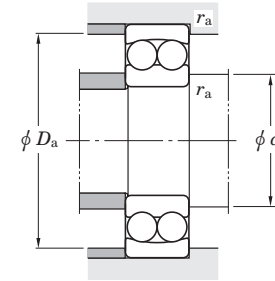
$d$  (35) ~ 65 mm



Cylindrical bore



Tapered bore  
Taper 1/12



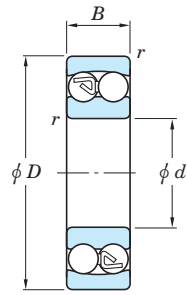
Boundary dimensions (mm)				Basic load ratings (kN)		Fatigue load limit (kN)	Limiting speeds (min <sup>-1</sup> )		Bearing No.		Mounting dimensions (mm)			Con-stant	Axial load factors			(Refer.) Mass (kg)	
$d$	$D$	$B$	$r_{min.}$	$C_r$	$C_{0r}$	$C_u$	Grease lub.	Oil lub.	Cylindrical bore	Tapered bore	$d_a$ min.	$D_a$ max.	$r_a$ max.	$e$	$Y_1$	$Y_2$	$Y_0$	Cylindrical bore	Tapered bore
35	72	23	1.1	21.6	6.65	0.42	8 500	10 000	2207	2207K	41.5	65.5	1	0.37	1.71	2.65	1.79	0.403	0.396
	80	21	1.5	25.1	7.95	0.49	7 600	9 300	1307	1307K	43	72	1.5	0.25	2.48	3.84	2.60	0.510	0.502
	80	31	1.5	39.5	11.1	0.71	7 100	9 800	2307	2307K	43	72	1.5	0.45	1.39	2.15	1.46	0.675	0.657
40	80	18	1.1	19.2	6.50	0.41	7 500	9 200	1208	1208K	46.5	73.5	1	0.22	2.83	4.38	2.97	0.417	0.411
	80	23	1.1	22.4	7.35	0.46	7 600	9 300	2208	2208K	46.5	73.5	1	0.33	1.92	2.96	2.01	0.505	0.494
	90	23	1.5	29.6	9.80	0.61	6 900	8 400	1308	1308K	48	82	1.5	0.25	2.57	3.98	2.69	0.715	0.704
	90	33	1.5	44.9	13.4	0.85	6 200	8 600	2308	2308K	48	82	1.5	0.43	1.47	2.27	1.54	0.925	0.903
45	85	19	1.1	21.8	7.35	0.46	7 000	8 500	1209	1209K	51.5	78.5	1	0.21	2.94	4.56	3.09	0.465	0.459
	85	23	1.1	23.3	8.15	0.51	7 000	8 500	2209	2209K	51.5	78.5	1	0.30	2.09	3.23	2.19	0.545	0.533
	100	25	1.5	38.1	12.9	0.80	6 100	7 500	1309	1309K	53	92	1.5	0.25	2.56	3.95	2.68	0.957	0.942
	100	36	1.5	54.4	16.6	1.05	5 600	7 700	2309	2309K	53	92	1.5	0.42	1.51	2.33	1.58	1.23	1.20
50	90	20	1.1	22.7	8.10	0.51	6 500	7 900	1210	1210K	56.5	83.5	1	0.21	3.07	4.76	3.22	0.525	0.515
	90	23	1.1	23.3	8.50	0.53	6 500	7 900	2210	2210K	56.5	83.5	1	0.27	2.33	3.61	2.45	0.590	0.577
	110	27	2	43.4	14.2	0.89	5 600	6 800	1310	1310K	59	101	2	0.23	2.70	4.17	2.83	1.21	1.19
	110	40	2	64.6	20.1	1.25	5 100	7 000	2310	2310K	59	101	2	0.40	1.56	2.41	1.63	1.64	1.60
55	100	21	1.5	26.8	10.0	0.63	5 800	7 100	1211	1211K	63	92	1.5	0.20	3.19	4.94	3.34	0.705	0.693
	100	25	1.5	26.5	9.95	0.62	5 800	7 100	2211	2211K	63	92	1.5	0.27	2.35	3.64	2.47	0.810	0.792
	120	29	2	51.3	18.1	1.10	5 000	6 200	1311	1311K	64	111	2	0.23	2.70	4.18	2.83	1.58	1.56
	120	43	2	75.4	23.8	1.50	4 600	6 400	2311	2311K	64	111	2	0.41	1.53	2.37	1.60	2.10	2.05
60	110	22	1.5	30.2	11.6	0.73	5 200	6 400	1212	1212K	68	102	1.5	0.19	3.37	5.22	3.53	0.900	0.885
	110	28	1.5	34.1	12.5	0.80	5 300	6 500	2212	2212K	68	102	1.5	0.28	2.26	3.49	2.36	1.09	1.07
	130	31	2.1	57.1	20.8	1.30	4 500	5 500	1312	1312K	71	119	2	0.22	2.91	4.50	3.05	1.96	1.93
	130	46	2.1	87.3	28.1	1.80	4 200	5 800	2312	2312K	71	119	2	0.39	1.62	2.51	1.70	2.60	2.53
65	120	23	1.5	31.0	12.4	0.79	4 800	5 800	1213	1213K	73	112	1.5	0.17	3.67	5.68	3.84	1.15	1.13
	120	31	1.5	43.6	16.4	1.05	4 900	5 900	2213	2213K	73	112	1.5	0.28	2.24	3.47	2.35	1.46	1.43
	140	33	2.1	61.7	22.9	1.40	4 300	5 200	1313	1313K	76	129	2	0.23	2.73	4.23	2.86	2.45	2.41

[Remark] Standard cage types used for the above bearings are described earlier in this section.

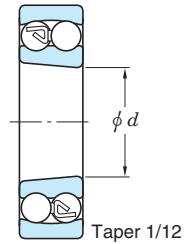


# Self-aligning ball bearings open type

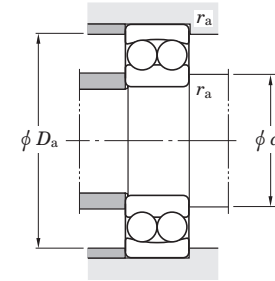
$d$  70 ~ 90 mm



Cylindrical bore



Tapered bore  
Taper 1/12

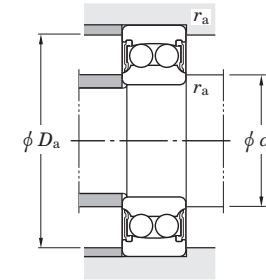
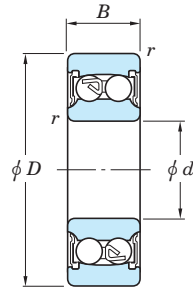


Boundary dimensions (mm)				Basic load ratings (kN)		Fatigue load limit (kN) $C_u$	Limiting speeds ( $\text{min}^{-1}$ )		Bearing No.		Mounting dimensions (mm)			Con-stant $e$	Axial load factors			(Refer.) Mass (kg)	
$d$	$D$	$B$	$r_{\text{min.}}$	$C_r$	$C_{0r}$		Grease lub.	Oil lub.	Cylindrical bore	Tapered bore	$d_a$ min.	$D_a$ max.	$r_a$ max.		$Y_1$	$Y_2$	$Y_0$	Cylindrical bore	Tapered bore
70	125	24	1.5	34.7	13.7	0.87	4 600	5 700	1214	—	78	117	1.5	0.18	3.48	5.38	3.64	1.26	—
	150	35	2.1	74.0	27.6	1.65	4 000	4 900	1314	—	81	139	2	0.22	2.84	4.40	2.98	2.99	—
75	130	25	1.5	38.8	15.5	0.97	4 300	5 300	1215	1215K	83	122	1.5	0.17	3.60	5.58	3.77	1.36	1.34
	160	37	2.1	78.9	29.9	1.70	4 000	4 900	1315	1315K	86	149	2	0.23	2.80	4.33	2.93	3.56	3.51
80	140	26	2	39.7	16.9	1.00	4 000	4 900	1216	1216K	89	131	2	0.16	3.90	6.03	4.08	1.67	1.64
	170	39	2.1	88.1	32.9	1.85	3 500	4 300	1316	1316K	91	159	2	0.22	2.90	4.49	3.04	4.18	4.12
85	150	28	2	49.2	20.5	1.20	3 800	4 600	1217	1217K	94	141	2	0.17	3.61	5.59	3.78	2.07	2.04
	180	41	3	97.3	37.8	2.05	3 300	4 000	1317	1317K	98	167	2.5	0.22	2.93	4.53	3.07	4.98	4.91
90	160	30	2	56.8	23.4	1.30	3 500	4 300	1218	1218K	99	151	2	0.17	3.69	5.70	3.86	2.52	2.48
	190	43	3	116	44.7	2.35	3 100	3 800	1318	1318K	103	177	2.5	0.22	2.81	4.35	2.94	5.80	5.71

[Remark] Standard cage types used for the above bearings are described earlier in this section.

Self-aligning ball bearings  
sealed type

$d$  10 ~ 55 mm

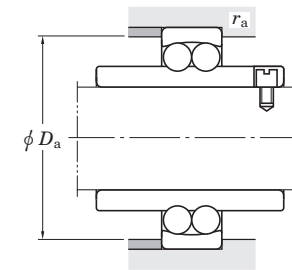
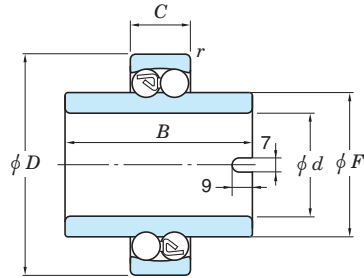


Boundary dimensions (mm)				Basic load ratings (kN)		Fatigue load limit (kN)	Limiting speed (min <sup>-1</sup> )	Bearing No.	Mounting dimensions (mm)				Constant $e$	Axial load factors			(Refer.) Mass (kg)
$d$	$D$	$B$	$r_{min.}$	$C_r$	$C_{0r}$	$C_u$	Grease lub.		$d_a$ min.	$d_a$ max.	$D_a$ max.	$r_a$ max.		$Y_1$	$Y_2$	$Y_0$	
10	30	14	0.6	5.50	1.20	0.08	15 000	2200 2RS	13.7	13.7	25	0.6	0.33	1.92	2.97	2.01	0.047
12	32	14	0.6	5.60	1.25	0.08	14 000	2201 2RS	15.2	15.2	27	0.6	0.33	1.89	2.93	1.98	0.053
15	35	14	0.6	7.45	1.75	0.11	12 000	2202 2RS 2302 2RS	18.0	18.0	30	0.6	0.33	1.90	2.95	2.00	0.060
	42	17	1	9.55	2.30	0.14	11 000		20.0	20.0	36	1	0.34	1.86	2.88	1.95	0.114
17	40	16	0.6	7.90	2.05	0.13	11 000	2203 2RS 2303 2RS	20.2	20.2	35	0.6	0.31	2.03	3.14	2.12	0.088
	47	19	1	12.5	3.20	0.20	9 400		22.1	22.1	41	1	0.33	1.92	2.97	2.01	0.158
20	47	18	1	9.90	2.65	0.16	9 100	2204 2RS 2304 2RS	24.1	24.1	41	1	0.29	2.16	3.35	2.27	0.140
	52	21	1.1	12.4	3.35	0.21	8 300		26.2	26.2	45	1	0.30	2.12	3.28	2.22	0.209
25	52	18	1	12.1	3.30	0.21	7 900	2205 2RS 2305 2RS	29.4	29.4	46	1	0.28	2.28	3.52	2.39	0.163
	62	24	1.1	18.0	5.05	0.32	6 600		32	33.9	55	1	0.27	2.31	3.57	2.42	0.335
30	62	20	1	15.6	4.70	0.29	6 600	2206 2RS 2306 2RS	35.5	35.5	56	1	0.25	2.55	3.94	2.67	0.260
	72	27	1.1	21.3	6.30	0.40	5 800		37	37.8	65	1	0.26	2.40	3.72	2.52	0.500
35	72	23	1.1	15.8	5.15	0.32	5 700	2207 2RS 2307 2RS	40.9	40.9	65	1	0.23	2.71	4.20	2.84	0.403
	80	31	1.5	25.1	7.95	0.49	5 100		43.5	45.0	71.5	1.5	0.25	2.48	3.84	2.60	0.675
40	80	23	1.1	19.2	6.50	0.41	5 000	2208 2RS 2308 2RS	47	48.1	73	1	0.22	2.83	4.38	2.97	0.505
	90	33	1.5	29.6	9.80	0.61	4 600		48.5	49.6	81.5	1.5	0.25	2.57	3.98	2.69	0.925
45	85	23	1.1	21.8	7.35	0.46	4 600	2209 2RS 2309 2RS	52	52.4	78	1	0.21	2.94	4.56	3.09	0.545
	100	36	1.5	38.1	12.9	0.80	4 100		53.5	56.6	91.5	1.5	0.25	2.56	3.95	2.68	1.23
50	90	23	1.1	22.7	8.10	0.51	4 300	2210 2RS 2310 2RS	56.5	56.5	83	1	0.21	3.07	4.76	3.22	0.590
	110	40	2	43.4	14.2	0.89	3 700		60	62.5	100	2	0.23	2.70	4.17	2.83	1.64
55	100	25	1.5	26.8	10.0	0.63	3 900	2211 2RS	63.5	63.5	91.5	1.5	0.20	3.19	4.94	3.34	0.810

[Remark] Standard cage types used for the above bearings are described earlier in this section.

Self-aligning ball bearings  
extended inner ring type

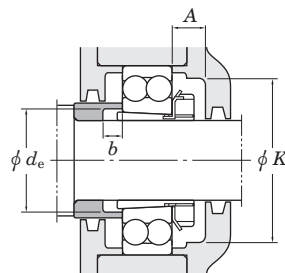
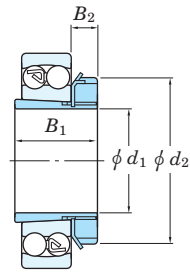
$d$  20 ~ 60 mm



Boundary dimensions (mm)						Basic load ratings (kN)		Fatigue load limit (kN) $C_u$	Limiting speeds ( $\text{min}^{-1}$ )		Bearing No.	Mounting dimensions (mm)		Constant $e$	Axial load factors			(Refer.) Mass (kg)
$d$	$D$	$B$	$C$	$F$	$r_{\text{min.}}$	$C_r$	$C_{0r}$		Grease lub.	Oil lub.		$D_a$ max.	$r_a$ max.		$Y_1$	$Y_2$	$Y_0$	
20	47	40	14	29.2	1	9.90	2.65	0.16	14 000	17 000	11204 11304	42	1	0.29	2.16	3.35	2.27	0.191
	52	44	15	31.5	1.1	12.4	3.35	0.21	13 000	15 000		45.5	1	0.30	2.12	3.28	2.22	0.266
25	52	44	15	33.3	1	12.1	3.30	0.21	12 000	14 000	11205 11305	47	1	0.28	2.28	3.52	2.39	0.226
	62	48	17	38	1.1	18.0	5.05	0.32	9 900	12 000		55.5	1	0.27	2.31	3.57	2.42	0.445
30	62	48	16	40.1	1	15.6	4.70	0.29	9 900	12 000	11206 11306	57	1	0.25	2.55	3.94	2.67	0.360
	72	52	19	45	1.1	21.3	6.30	0.40	8 700	11 000		65.5	1	0.26	2.40	3.72	2.52	0.614
35	72	52	17	47.7	1.1	15.8	5.15	0.32	8 500	10 000	11207 11307	65.5	1	0.23	2.71	4.20	2.84	0.556
	80	56	21	51.7	1.5	25.1	7.95	0.49	7 600	9 300		72	1.5	0.25	2.48	3.84	2.60	0.821
40	80	56	18	54	1.1	19.2	6.50	0.41	7 500	9 200	11208 11308	73.5	1	0.22	2.83	4.38	2.97	0.733
	90	58	23	57.7	1.5	29.6	9.80	0.61	6 900	8 400		82	1.5	0.25	2.57	3.98	2.69	1.09
45	85	58	19	57.7	1.1	21.8	7.35	0.46	7 000	8 500	11209 11309	78.5	1	0.21	2.94	4.56	3.09	0.793
	100	60	25	63.9	1.5	38.1	12.9	0.80	6 100	7 500		92	1.5	0.25	2.56	3.95	2.68	1.40
50	90	58	20	62.7	1.1	22.7	8.10	0.51	6 500	7 900	11210 11310	83.5	1	0.21	3.07	4.76	3.22	0.875
	110	62	27	70.3	2	43.4	14.2	0.89	5 600	6 800		102	2	0.23	2.70	4.17	2.83	1.74
55	100	60	21	70.3	1.5	26.8	10.0	0.63	5 800	7 100	11211	93.5	1.5	0.20	3.19	4.94	3.34	1.16
60	110	62	22	78	1.5	30.2	11.6	0.73	5 200	6 400	11212	103.5	1.5	0.19	3.37	5.22	3.53	1.52

Adapter assemblies for self-aligning ball bearings

$d_1$  17 ~ (45) mm



$d_1$  (45) ~ 80 mm

Boundary dimensions (mm)				Brg. bore $d$ (mm)	Designations Bearing + adapter ass'y	Mounting dimensions (mm)				Mass Brg.+adapter ass'y (kg)	(Refer.)	
$d_1$	$B_1$	$d_2$	$B_2$			A min.	K min.	$d_e$ min.	$b$ min.		Adapter sleeve No.	Locknut No.
<b>17</b>	24	32	7	20	1204K+H204X	—	—	23	5	0.162	A204X	AN04
	28	32	7	20	2204K+H304X	—	—	24	5	0.185	A304X	AN04
	28	32	7	20	1304K+H304X	—	—	24	8	0.210	A304X	AN04
	31	32	7	20	2304K+H2304X	—	—	24	5	0.257	A2304X	AN04
<b>20</b>	26	38	8	25	1205K+H205X	15	45	28	5	0.218	A205X	AN05
	29	38	8	25	2205K+H305X	15	45	29	5	0.243	A305X	AN05
	29	38	8	25	1305K+H305X	15	45	29	6	0.337	A305X	AN05
	35	38	8	25	2305K+H2305X	15	45	29	5	0.424	A2305X	AN05
<b>25</b>	27	45	8	30	1206K+H206X	15	50	33	5	0.320	A206X	AN06
	31	45	8	30	2206K+H306X	15	50	34	5	0.368	A306X	AN06
	31	45	8	30	1306K+H306X	15	50	34	6	0.495	A306X	AN06
	38	45	8	30	2306K+H2306X	15	50	35	5	0.620	A2306X	AN06
<b>30</b>	29	52	9	35	1207K+H207X	17	58	38	5	0.462	A207X	AN07
	35	52	9	35	2207K+H307X	17	58	39	5	0.557	A307X	AN07
	35	52	9	35	1307K+H307X	17	58	39	7	0.663	A307X	AN07
	43	52	9	35	2307K+H2307X	17	58	40	5	0.843	A2307X	AN07
<b>35</b>	31	58	10	40	1208K+H208X	17	65	44	5	0.597	A208X	AN08
	36	58	10	40	2208K+H308X	17	65	44	5	0.696	A308X	AN08
	36	58	10	40	1308K+H308X	17	65	44	5	0.906	A308X	AN08
	46	58	10	40	2308K+H2308X	17	65	45	5	1.14	A2308X	AN08
<b>40</b>	33	65	11	45	1209K+H209X	17	72	49	5	0.701	A209X	AN09
	39	65	11	45	2209K+H309X	17	72	49	8	0.798	A309X	AN09
	39	65	11	45	1309K+H309X	17	72	49	5	1.21	A309X	AN09
	50	65	11	45	2309K+H2309X	17	72	50	5	1.51	A2309X	AN09
<b>45</b>	35	70	12	50	1210K+H210X	19	76	53	5	0.804	A210X	AN10
	42	70	12	50	2210K+H310X	19	76	54	10	0.896	A310X	AN10

Boundary dimensions (mm)				Brg. bore $d$ (mm)	Designations Bearing + adapter ass'y	Mounting dimensions (mm)				Mass Brg.+adapter ass'y (kg)	(Refer.)	
$d_1$	$B_1$	$d_2$	$B_2$			A min.	K min.	$d_e$ min.	$b$ min.		Adapter sleeve No.	Locknut No.
<b>45</b>	42	70	12	50	1310K+H310X	19	76	54	5	1.51	A310X	AN10
	55	70	12	50	2310K+H2310X	19	76	56	5	1.98	A2310X	AN10
<b>50</b>	37	75	12	55	1211K+H211X	19	85	60	6	1.02	A211X	AN11
	45	75	12	55	2211K+H311X	19	85	60	11	1.16	A311X	AN11
	45	75	12	55	1311K+H311X	19	85	60	6	1.93	A311X	AN11
	59	75	12	55	2311K+H2311X	19	85	61	6	2.50	A2311X	AN11
<b>55</b>	38	80	13	60	1212K+H212X	20	90	61	5	1.25	A212X	AN12
	47	80	13	60	2212K+H312X	20	90	65	9	1.49	A312X	AN12
	47	80	13	60	1312K+H312X	20	90	65	5	2.35	A312X	AN12
	62	80	13	60	2312K+H2312X	20	90	66	5	3.04	A2312X	AN12
<b>60</b>	40	85	14	65	1213K+H213X	21	96	70	5	1.56	A213X	AN13
	50	85	14	65	2213K+H313X	21	96	70	8	1.92	A313X	AN13
	50	85	14	65	1313K+H313X	21	96	70	5	2.90	A313X	AN13
<b>65</b>	43	98	15	75	1215K+H215X	23	110	80	5	2.09	A215X	AN15
	55	98	15	75	1315K+H315X	23	110	80	5	4.40	A315X	AN15
<b>70</b>	46	105	17	80	1216K+H216X	25	120	85	5	2.57	A216X	AN16
	59	105	17	80	1316K+H316X	25	120	86	5	5.21	A316X	AN16
<b>75</b>	50	110	18	85	1217K+H217X	27	128	90	6	3.11	A217X	AN17
	63	110	18	85	1317K+H317X	27	128	91	6	6.15	A317X	AN17
<b>80</b>	52	120	18	90	1218K+H218X	28	139	95	6	3.75	A218X	AN18
	65	120	18	90	1318K+H318X	28	139	96	6	7.16	A318X	AN18

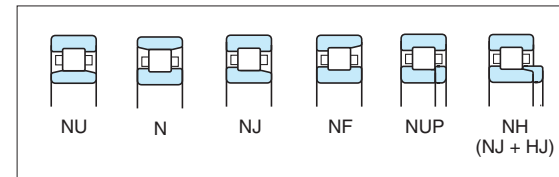
## Cylindrical roller bearings

Cylindrical roller bearings feature high radial load capacity because the rollers and raceway are in linear contact. These bearings are suitable for applications that involve heavy radial and impact loading.

They are also appropriate for high-speed applications in that they can be machined very accurately due to their structure.

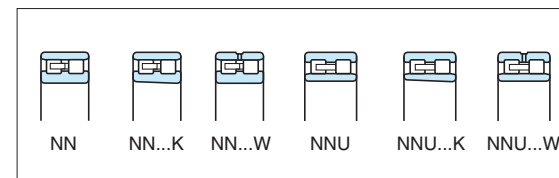
Having a separable inner ring or outer ring, these bearings can be mounted and dismantled easily.

### ■ Single-row cylindrical roller bearings



- The NU and N types exhibit their best performance when used as free side bearings since they adjust to the shaft's axial movement, to a certain extent, relative to the housing position.
- The NJ and NF types carry axial load in one direction, while the NUP and NH types can carry a certain degree of axial load in both directions.
- Type R cylindrical roller bearings feature enhanced load rating compared with standard series, though both have equal dimensions. This is because type R bearings have different internal design. They are identified by supplementary code "R".

### ■ Double-row cylindrical roller bearings



- Double-row cylindrical roller bearings come in two types : with a cylindrical bore, and with a tapered bore. As for those with a tapered bore, the specified amount of clearance can be obtained by adjusting the press-in distance. Some bearings have lubrication holes and lubrication grooves on the outer ring. They are identified by supplementary code "W".
- These bearings can accommodate high radial loads, and are often used on machine tool spindles.

### Single-row cylindrical roller bearings



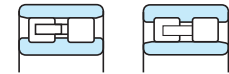
Bore diameter **20 – 460 mm**



Thrust collar

Bore diameter **20 – 320 mm**

### Double-row cylindrical roller bearings



NN

NNU

Bore diameter **25 – 480 mm**



Boundary dimensions	The dimensions of standard series are as specified in JIS B 1512.																																																												
Tolerances	As specified in JIS B 1514-1 (refer to Table 7-3 on pp. A 60 – A 63).																																																												
	Tolerances of roller set bore diameter $F_w$ and roller set outside diameter $E_w$ of interchangeable bearings are as follows : Unit : $\mu\text{m}$																																																												
	<table border="1"> <thead> <tr> <th colspan="2">Nominal bore diameter <math>d</math> (mm)</th> <th colspan="2"><math>\Delta_{Fw}</math> Roller set bore diameter deviation</th> <th colspan="2"><math>\Delta_{Ew}</math> Roller set outside diameter deviation</th> </tr> <tr> <th>over</th> <th>up to</th> <th>upper</th> <th>lower</th> <th>upper</th> <th>lower</th> </tr> </thead> <tbody> <tr> <td>–</td> <td>20</td> <td>+ 10</td> <td>0</td> <td>0</td> <td>– 10</td> </tr> <tr> <td>20</td> <td>50</td> <td>+ 15</td> <td>0</td> <td>0</td> <td>– 15</td> </tr> <tr> <td>50</td> <td>120</td> <td>+ 20</td> <td>0</td> <td>0</td> <td>– 20</td> </tr> <tr> <td>120</td> <td>200</td> <td>+ 25</td> <td>0</td> <td>0</td> <td>– 25</td> </tr> <tr> <td>200</td> <td>250</td> <td>+ 30</td> <td>0</td> <td>0</td> <td>– 30</td> </tr> <tr> <td>250</td> <td>315</td> <td>+ 35</td> <td>0</td> <td>0</td> <td>– 35</td> </tr> <tr> <td>315</td> <td>400</td> <td>+ 40</td> <td>0</td> <td>0</td> <td>– 40</td> </tr> <tr> <td>400</td> <td>500</td> <td>+ 45</td> <td>0</td> <td>–</td> <td>–</td> </tr> </tbody> </table>	Nominal bore diameter $d$ (mm)		$\Delta_{Fw}$ Roller set bore diameter deviation		$\Delta_{Ew}$ Roller set outside diameter deviation		over	up to	upper	lower	upper	lower	–	20	+ 10	0	0	– 10	20	50	+ 15	0	0	– 15	50	120	+ 20	0	0	– 20	120	200	+ 25	0	0	– 25	200	250	+ 30	0	0	– 30	250	315	+ 35	0	0	– 35	315	400	+ 40	0	0	– 40	400	500	+ 45	0	–	–
	Nominal bore diameter $d$ (mm)		$\Delta_{Fw}$ Roller set bore diameter deviation		$\Delta_{Ew}$ Roller set outside diameter deviation																																																								
over	up to	upper	lower	upper	lower																																																								
–	20	+ 10	0	0	– 10																																																								
20	50	+ 15	0	0	– 15																																																								
50	120	+ 20	0	0	– 20																																																								
120	200	+ 25	0	0	– 25																																																								
200	250	+ 30	0	0	– 30																																																								
250	315	+ 35	0	0	– 35																																																								
315	400	+ 40	0	0	– 40																																																								
400	500	+ 45	0	–	–																																																								
[Remark] Interchangeable bearings have an inner ring with rollers that can be matched with the outer ring, or an outer ring with rollers that can be matched with the inner ring, without affecting performance in the bearing that has the same bearing number in one category.																																																													
Tapered bore tolerance and allowable values of high precision double-row cylindrical roller bearings (classes 5 and 4) are provided in JTEKT standards (refer to Table 7-11 on p. A 76).																																																													
Radial internal clearance	· Cylindrical bore and tapered bore bearings .....(refer to Table 10-8 on pp. A 106, 107.) · Motor bearings.....(refer to Table 10-7 on p. A 105.)																																																												
Recommended fits	Refer to Table 9-4 on pp. A 91, 92.																																																												
Standard cages	<ul style="list-style-type: none"> <li>■ For single-row cylindrical roller bearings : <ul style="list-style-type: none"> <li>· Pressed steel cage (supplementary code : //)</li> <li>· Copper alloy machined cage (supplementary code : FY)</li> </ul> </li> </ul> <p style="margin-left: 100px;">( Copper alloy machined cages without rivets (LY) are also used for some special purposes. )</p> <ul style="list-style-type: none"> <li>■ For double-row cylindrical roller bearings : <ul style="list-style-type: none"> <li>· Prong type copper alloy machined cage (supplementary code : FY)</li> <li>· Separable prong type copper alloy machined cage (supplementary code : FW)</li> </ul> </li> </ul> <p style="margin-left: 100px;">.....for class 5 or higher precision bearings</p>																																																												

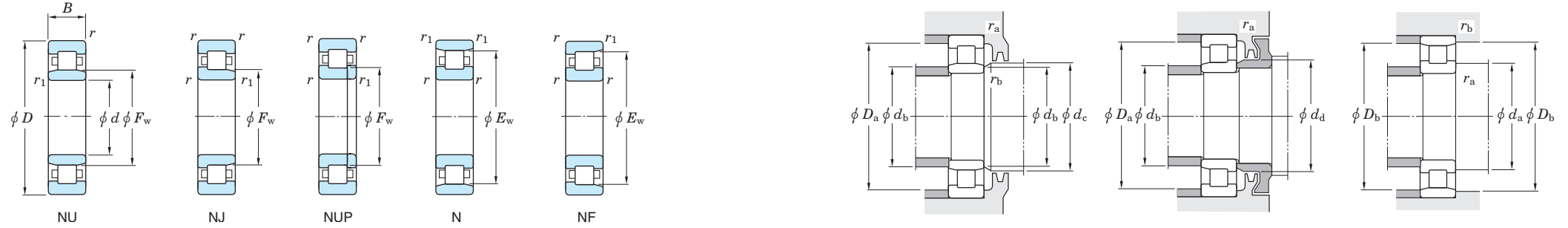
Allowable misalignment	Allowable misalignment of single-row cylindrical roller bearings depends on bearing type and specification. General values are as follows : 1) When $P_r/C_r$ is approx. 8% under load of normal use .....0.000 6 rad (2') – 0.000 9 rad (3') 2) When $P_r/C_r$ is approx. 5% under load lighter than 1) .....0.001 2 rad (4') When very large allowable misalignment is required, consult with JTEKT.
Equivalent radial load	Dynamic equivalent radial load $P_r = F_r$ Static equivalent radial load $P_{0r} = F_r$
Allowable axial load	Cylindrical roller bearings with ribs, including loose rib and thrust collar, on both inner and outer rings accommodate axial load to a certain extent. (NJ and NF types accommodate load applied in one direction : NUP and NH in both directions.) For calculation of allowable axial load, refer to p. A 44.

**Table 1 Application of standard cages**

Bearing series	Pressed cage	Synthetic resin molded cage	Machined cage
NU, NUP 10	—	—	1005 – 1092
N, NF 2	204 – 220	—	204 – 264
NU, NJ, NUP 2	—	—	244 – 264
NU, NJ, NUP 2 R	—	204R – 213R	214R – 240R
NU, NJ, NUP 22	2204 – 2220	—	2204 – 2252
NU, NJ, NUP 22 R	2204R – 2220R	—	2204R – 2240R
NU 32	—	—	3206 – 3252
N, NF 3	304 – 320	—	304 – 348
NU, NJ, NUP 3	—	—	334 – 348
NU, NJ, NUP 3 R	—	304R – 314R	315R – 332R
NU, NJ, NUP 23	2304 – 2320	—	2304 – 2340
NU, NJ, NUP 23 R	2304R – 2320R	—	2304R – 2332R
NU 33	—	—	3306 – 3352
NU, NJ, NUP, NF 4	406 – 420	—	406 – 430

Single-row cylindrical roller bearings

$d$  20 ~ (30) mm



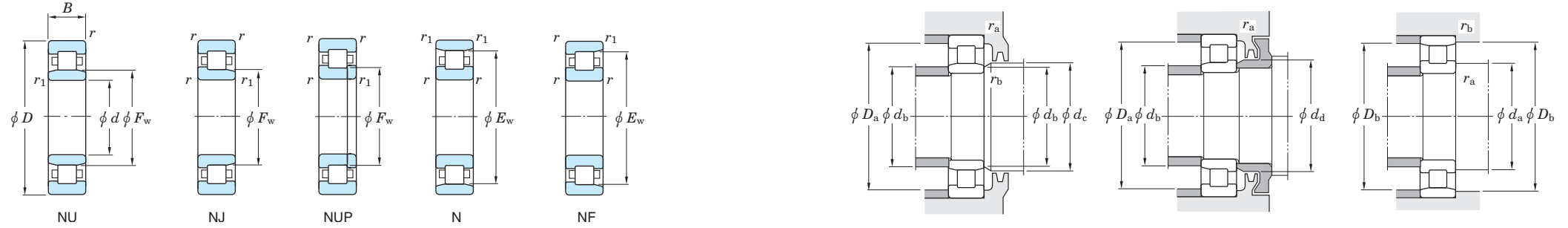
Boundary dimensions (mm)			Basic load ratings (kN)		Fatigue load limit (kN) $C_u$	Limiting speeds (min <sup>-1</sup> )		Bearing No.					Mounting dimensions (mm)								Mass (kg)						
$d$	$D$	$B$	$r$ min.	$r_1$ min.		$F_w$	$E_w$	$C_r$	$C_{0r}$	Grease lub.	Oil lub.	NU	NJ	NUP	N	NF	$d_a$ min.	$d_b$ min.	$d_b$ max.	$d_c$ min.		$d_d$ min.	$D_a$ max.	$D_b$ max.	$r_a$ min.	$r_b$ max.	
20	47	14	1	0.6	—	40	19.3	12.7	1.45	15 000	18 000	—	—	—	—	25	—	—	—	32	42	43	42	1	0.6	(0.108)	
	47	14	1	0.6	26.5	—	32.2	22.6	3.05	15 000	18 000	NU204R	NJ204R	NUP204R	—	25	24	26	29	32	42	—	—	1	0.6	0.112	
	47	18	1	0.6	27	—	27.8	18.4	2.70	13 000	18 000	NU2204	NJ2204	NUP2204	—	25	24	26	29	32	42	—	—	1	0.6	0.146	
	47	18	1	0.6	26.5	—	38.3	28.3	3.60	13 000	18 000	NU2204R	NJ2204R	NUP2204R	—	25	24	26	29	32	42	—	—	1	0.6	0.146	
	52	15	1.1	0.6	—	44.5	28.9	19.2	2.50	12 000	16 000	—	—	—	N304	NF304	26.5	—	—	—	33	45.5	48	45.5	1	0.6	(0.147)
	52	15	1.1	0.6	27.5	—	39.4	26.9	3.75	12 000	16 000	NU304R	NJ304R	NUP304R	—	26.5	24	27	30	33	45.5	—	—	1	0.6	0.153	
	52	21	1.1	0.6	28.5	—	38.0	30.2	3.60	11 000	16 000	NU2304	NJ2304	NUP2304	—	26.5	24	27	30	33	45.5	—	—	1	0.6	0.212	
	52	21	1.1	0.6	27.5	—	52.5	38.8	5.40	11 000	16 000	NU2304R	NJ2304R	NUP2304R	—	26.5	24	27	30	33	45.5	—	—	1	1	0.215	
	25	47	12	0.6	0.3	30.5	—	17.8	13.1	2.25	15 000	18 000	NU1005	—	NUP1005	—	29	27	30	32	—	43	—	—	0.6	0.3	0.084
52		15	1	0.6	—	45	22.1	15.7	1.80	13 000	16 000	—	—	—	N205	NF205	30	—	—	—	37	47	48	47	1	0.6	(0.132)
52		15	1	0.6	31.5	—	36.7	27.7	3.75	13 000	15 000	NU205R	NJ205R	NUP205R	—	30	29	31	34	37	47	—	—	1	0.6	0.138	
52		18	1	0.6	32	—	29.6	22.8	3.05	12 000	16 000	NU2205	NJ2205	NUP2205	—	30	29	31	34	37	47	—	—	1	0.6	0.163	
52		18	1	0.6	31.5	—	43.6	34.6	4.40	12 000	15 000	NU2205R	NJ2205R	NUP2205R	—	30	29	31	34	37	47	—	—	1	0.6	0.166	
62		17	1.1	1.1	—	53	36.6	25.2	3.45	10 000	14 000	—	—	—	N305	NF305	31.5	—	—	—	40	55.5	55.5	55	1	1	(0.235)
62		17	1.1	1.1	34	—	51.9	37.4	4.85	10 000	14 000	NU305R	NJ305R	NUP305R	—	31.5	31.5	33	37	40	55.5	—	—	1	1	0.243	
62		24	1.1	1.1	35	—	53.4	40.9	5.70	9 100	14 000	NU2305	NJ2305	NUP2305	—	31.5	31.5	33	37	40	55.5	—	—	1	1	0.340	
62		24	1.1	1.1	34	—	71.2	56.1	7.50	9 100	14 000	NU2305R	NJ2305R	NUP2305R	—	31.5	31.5	33	37	40	55.5	—	—	1	1	0.350	
30	55	13	1	0.6	36.5	—	23.4	18.4	2.05	13 000	15 000	NU1006	—	NUP1006	—	35	34	35	38	—	50	—	—	1	0.6	0.121	
	62	16	1	0.6	—	53.5	31.1	21.5	2.95	11 000	13 000	—	—	—	N206	NF206	35	—	—	—	44	57	58	56	1	0.6	(0.206)
	62	16	1	0.6	37.5	—	48.9	37.4	5.25	11 000	13 000	NU206R	NJ206R	NUP206R	—	35	34	37	40	44	57	—	—	1	0.6	0.209	
	62	20	1	0.6	38.5	—	41.0	33.1	4.20	9 800	13 000	NU2206	NJ2206	NUP2206	—	35	34	37	40	44	57	—	—	1	0.6	0.262	
	62	20	1	0.6	37.5	—	61.2	49.8	6.80	9 700	13 000	NU2206R	NJ2206R	NUP2206R	—	35	34	37	40	44	57	—	—	1	0.6	0.262	
	62	23.8	1	1	38.5	—	53.3	46.4	5.95	8 700	13 000	NU3206	—	—	—	35	35	37	40	—	57	—	—	1	0.6	0.343	
	72	19	1.1	1.1	—	62	48.3	35.2	5.00	8 700	12 000	—	—	—	N306	NF306	36.5	—	—	—	48	65.5	65.5	64	1	1	(0.353)
	72	19	1.1	1.1	40.5	—	66.5	50.2	6.80	8 700	12 000	NU306R	NJ306R	NUP306R	—	36.5	36.5	40	44	48	65.5	—	—	1	1	0.361	
	72	27	1.1	1.1	42	—	64.3	50.8	7.15	7 700	12 000	NU2306	NJ2306	NUP2306	—	36.5	36.5	40	44	48	65.5	—	—	1	1	0.500	
	72	27	1.1	1.1	40.5	—	93.3	77.6	10.1	7 800	12 000	NU2306R	NJ2306R	NUP2306R	—	36.5	36.5	40	44	48	65.5	—	—	1	1	0.534	

[Remarks] 1) Standard cage types used for the above bearings are shown in Table 1 earlier in this section. Please note that basic load ratings and limiting speeds shown above indicate the value applicable to machined cage. Consult JTEKT about bearings with pressed cage, since they may be different from bearings with machined cage in values above.

2) Bearing numbers of NU and NJ type bearings with mounted thrust collar (refer to specification table shown after this specification table) are NUJ and NH.

Single-row cylindrical roller bearings

d (30) ~ (45) mm



Boundary dimensions (mm)								Basic load ratings (kN)		Fatigue load limit (kN)	Limiting speeds (min <sup>-1</sup> )		Bearing No.					Mounting dimensions (mm)								(Refer.) Mass NU (N) (kg)		
d	D	B	r min.	r1 min.	Fw	Ew	Cr	C0r	Cu	Grease lub.	Oil lub.	NU	NJ	NUP	N	NF	da min.	db min.	db max.	dc min.	dd min.	Da max.	Db max.	ra min.	rb max.	ra max.	rb max.	
30	72	30.2	1.1	1.1	42	—	86.4	74.3	9.95	7 700	12 000	NU3306	—	—	—	—	36.5	36.5	40	44	—	65.5	—	—	1	1	0.650	
	90	23	1.5	1.5	45	73	78.3	55.0	7.95	7 600	10 000	NU406	NJ406	NUP406	N406	NF406	38	38	44	47	52	82	82	74	1.5	1.5	0.753	
35	62	14	1	0.6	42	—	28.3	23.2	2.65	11 000	13 000	NU1007	—	NUP1007	—	—	40	39	41	44	—	57	—	—	1	0.5	0.182	
	72	17	1.1	0.6	—	61.8	44.6	31.5	4.70	9 500	11 000	—	—	—	N207	NF207	41.5	—	—	—	50	65.5	68	64	1	0.6	(0.293)	
	72	17	1.1	0.6	44	—	62.9	50.2	6.55	9 300	11 000	NU207R	NJ207R	NUP207R	—	—	41.5	39	43	46	50	65.5	—	—	1	0.6	0.306	
	72	23	1.1	0.6	43.8	—	61.3	51.2	7.15	8 500	11 000	NU2207	NJ2207	NUP2207	—	—	41.5	39	43	46	50	65.5	—	—	1	0.6	0.402	
	72	23	1.1	0.6	44	—	77.1	65.3	9.20	8 300	11 000	NU2207R	NJ2207R	NUP2207R	—	—	41.5	39	43	46	50	65.5	—	—	1	0.6	0.404	
	72	27	1.1	1.1	43.8	—	68.5	59.1	7.90	7 600	11 000	NU3207	—	—	—	—	—	41.5	41.5	43	46	—	65.5	—	—	1	0.6	0.524
	80	21	1.5	1.1	—	68.2	—	62.0	46.9	6.20	7 900	10 000	—	—	—	N307	NF307	43	—	—	—	53	72	73.5	71	1.5	1	(0.477)
	80	21	1.5	1.1	46.2	—	83.3	65.4	9.35	7 700	10 000	NU307R	NJ307R	NUP307R	—	—	43	41.5	45	48	53	72	—	—	1.5	1	0.482	
	80	31	1.5	1.1	46.2	—	75.5	65.7	7.95	7 000	10 000	NU2307	NJ2307	NUP2307	—	—	43	41.5	45	48	53	72	—	—	1.5	1	0.696	
	80	31	1.5	1.1	46.2	—	116	101	15.0	6 900	10 000	NU2307R	NJ2307R	NUP2307R	—	—	43	41.5	45	48	53	72	—	—	1.5	1	0.729	
	80	34.9	1.5	1.5	46.2	—	102	89.1	12.0	7 000	10 000	NU3307	—	—	—	—	—	43	43	45	48	—	72	—	—	1.5	1	0.908
	100	25	1.5	1.5	53	83	—	94.1	68.9	9.25	6 600	8 800	NU407	NJ407	NUP407	N407	NF407	43	43	52	55	61	92	92	84	1.5	1.5	1.02
40	68	15	1	0.6	47	—	31.2	25.7	3.10	10 000	12 000	NU1008	—	NUP1008	—	—	45	44	46	49	—	63	—	—	1	0.6	0.223	
	80	18	1.1	1.1	—	70	54.7	42.9	6.15	8 300	10 000	—	—	—	N208	NF208	46.5	—	—	—	56	73.5	73.5	72	1	1	(0.374)	
	80	18	1.1	1.1	49.5	—	69.6	55.4	7.35	8 300	9 900	NU208R	NJ208R	NUP208R	—	—	46.5	46.5	49	52	56	73.5	—	—	1	1	0.384	
	80	23	1.1	1.1	50	—	72.8	62.0	8.75	7 500	10 000	NU2208	NJ2208	NUP2208	—	—	46.5	46.5	49	52	56	73.5	—	—	1	1	0.490	
	80	23	1.1	1.1	49.5	—	90.5	77.6	10.3	7 400	9 900	NU2208R	NJ2208R	NUP2208R	—	—	46.5	46.5	49	52	56	73.5	—	—	1	1	0.490	
	80	30.2	1.1	1.1	50	—	97.8	90.6	12.2	6 700	10 000	NU3208	—	—	—	—	—	46.5	46.5	49	52	—	73.5	—	—	1	1	0.711
	90	23	1.5	1.5	—	77.5	—	73.4	56.9	7.85	6 900	9 100	—	—	—	N308	NF308	48	—	—	—	60	82	82	80	1.5	1.5	(0.646)
	90	23	1.5	1.5	52	—	104	81.5	11.0	6 800	9 100	NU308R	NJ308R	NUP308R	—	—	48	48	51	55	60	82	—	—	1.5	1.5	0.664	
	90	33	1.5	1.5	53.5	—	103	88.0	11.6	6 100	9 100	NU2308	NJ2308	NUP2308	—	—	48	48	51	55	60	82	—	—	1.5	1.5	0.956	
	90	33	1.5	1.5	52	—	143	122	18.4	6 100	9 100	NU2308R	NJ2308R	NUP2308R	—	—	48	48	51	55	60	82	—	—	1.5	1.5	0.962	
	90	36.5	1.5	1.5	53.5	—	130	119	17.6	6 100	9 100	NU3308	—	—	—	—	—	48	48	51	55	—	82	—	—	1.5	1.5	1.19
	110	27	2	2	58	92	—	120	89.1	12.6	6 000	8 000	NU408	NJ408	NUP408	N408	NF408	49	49	57	60	67	101	101	93	2	2	1.30
45	75	16	1	0.6	52.5	—	38.9	33.8	4.30	9 200	11 000	NU1009	—	NUP1009	—	—	50	49	52	54	—	70	—	—	1	0.6	0.289	

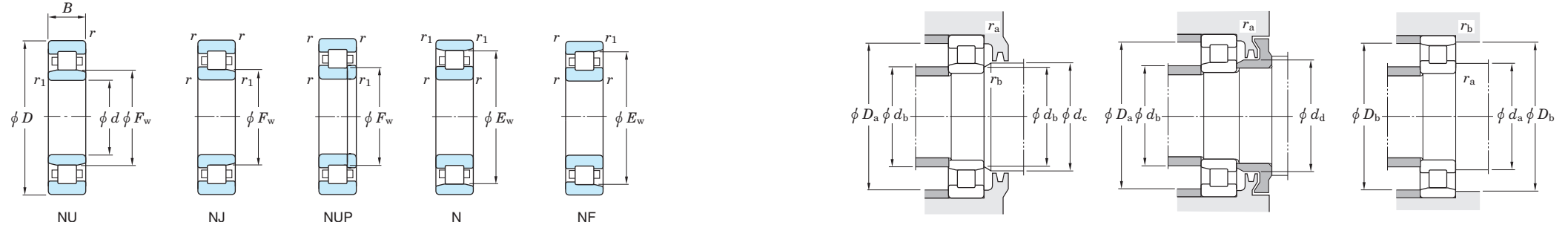
[Remarks] 1) Standard cage types used for the above bearings are shown in Table 1 earlier in this section. Please note that basic load ratings and limiting speeds shown above indicate the value applicable to machined cage. Consult JTEKT about bearings with pressed cage, since they may be different from bearings with machined cage in values above.

2) Bearing numbers of NU and NJ type bearings with mounted thrust collar (refer to specification table shown after this specification table) are NUJ and NH.



Single-row cylindrical roller bearings

d (45) ~ (55) mm



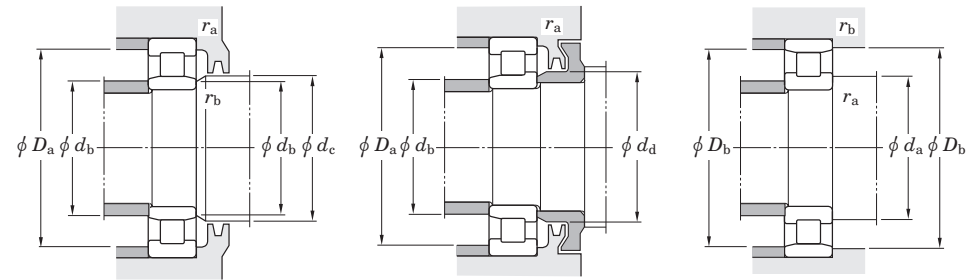
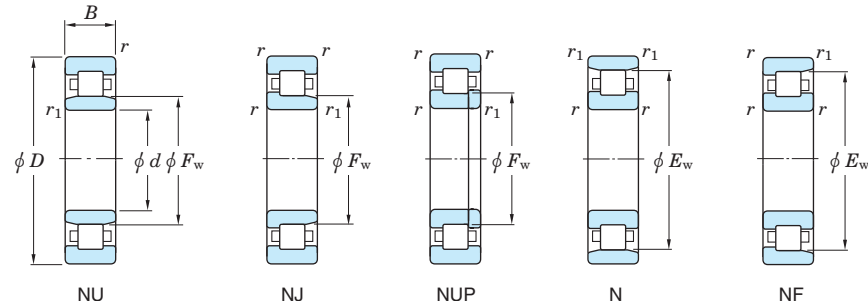
d	Boundary dimensions (mm)						Basic load ratings (kN)		Fatigue load limit (kN) $C_u$	Limiting speeds (min <sup>-1</sup> )		Bearing No.					Mounting dimensions (mm)								(Refer.) Mass NU (N) (kg)					
	D	B	r min.	r1 min.	Fw	Ew	Cr	C0r		Grease lub.	Oil lub.	NU	NJ	NUP	N	NF	da min.	db min.	db max.	dc min.	dd min.	Da max.	Db max.	ra min.		ra max.	rb min.	rb max.		
45	85	19	1.1	1.1	—	75	57.6	46.9	6.70	7 700	9 200	—	—	—	—	—	—	—	—	61	78.5	78.5	77	1	1	1	1	(0.427)		
	85	19	1.1	1.1	54.5	—	78.9	66.4	9.05	7 600	9 200	NU209R	NJ209R	NUP209R	—	—	51.5	51.5	54	57	61	78.5	—	—	1	1	1	1	0.439	
	85	23	1.1	1.1	55	—	76.6	67.8	9.60	6 900	9 200	NU2209	NJ2209	NUP2209	—	—	51.5	51.5	54	57	61	78.5	—	—	1	1	1	1	0.536	
	85	23	1.1	1.1	54.5	—	95.1	84.6	11.2	6 900	9 200	NU2209R	NJ2209R	NUP2209R	—	—	51.5	51.5	54	57	61	78.5	—	—	1	1	1	1	0.536	
	85	30.2	1.1	1.1	55	—	103	99.0	13.3	6 100	9 200	NU3209	—	—	—	—	51.5	51.5	54	57	—	78.5	—	—	1	1	1	1	0.770	
	100	25	1.5	1.5	—	86.5	98.5	77.5	11.3	6 200	8 300	—	—	—	N309	NF309	—	—	—	—	66	92	92	89	1.5	1.5	1.5	1.5	(0.865)	
	100	25	1.5	1.5	58.5	—	122	98.3	13.5	6 100	8 200	NU309R	NJ309R	NUP309R	—	—	53	53	57	60	66	92	—	—	1.5	1.5	1.5	1.5	0.909	
	100	36	1.5	1.5	58.5	—	124	113	14.3	5 500	8 300	NU2309	NJ2309	NUP2309	—	—	53	53	57	60	66	92	—	—	1.5	1.5	1.5	1.5	1.25	
	100	36	1.5	1.5	58.5	—	172	153	23.0	5 400	8 200	NU2309R	NJ2309R	NUP2309R	—	—	53	53	57	60	66	92	—	—	1.5	1.5	1.5	1.5	1.32	
	100	39.7	1.5	1.5	58.5	—	164	149	22.6	5 500	8 300	NU3309	—	—	—	—	53	53	57	60	—	92	—	—	1.5	1.5	1.5	1.5	1.59	
	120	29	2	2	64.5	100.5	134	112	13.8	5 400	7 200	NU409	NJ409	NUP409	N409	NF409	54	54	63	66	74	111	111	102	2	2	2	2	1.64	
	50	80	16	1	0.6	57.5	—	42.2	36.8	4.80	8 400	9 900	NU1010	—	—	NUP1010	—	—	55	54	57	59	—	75	—	—	1	0.6	0.306	
90		20	1.1	1.1	—	80.4	60.3	51.0	7.30	7 100	8 500	—	—	—	N210	NF210	56.5	—	—	—	67	83.5	83.5	82	1	1	1	1	(0.479)	
90		20	1.1	1.1	59.5	—	82.5	71.9	9.85	7 100	8 500	NU210R	NJ210R	NUP210R	—	—	56.5	56.5	58	62	67	83.5	—	—	1	1	1	1	0.497	
90		23	1.1	1.1	60.4	—	80.3	73.6	10.4	6 400	8 500	NU2210	NJ2210	NUP2210	—	—	56.5	56.5	58	62	67	83.5	—	—	1	1	1	1	0.580	
90		23	1.1	1.1	59.5	—	99.5	91.5	12.1	6 400	8 500	NU2210R	NJ2210R	NUP2210R	—	—	56.5	56.5	58	62	67	83.5	—	—	1	1	1	1	0.580	
90		30.2	1.1	1.1	60.4	—	108	108	14.5	5 700	8 500	NU3210	—	—	—	—	56.5	56.5	58	62	—	83.5	—	—	1	1	1	1	0.829	
110		27	2	2	—	95	109	93.4	11.7	5 600	7 500	—	—	—	N310	NF310	59	—	—	—	73	101	101	98	2	2	2	2	(1.15)	
110		27	2	2	65	—	138	113	16.0	5 500	7 400	NU310R	NJ310R	NUP310R	—	—	59	59	63	67	73	101	—	—	2	2	2	2	1.15	
110		40	2	2	65	—	151	142	20.1	5 000	7 500	NU2310	NJ2310	NUP2310	—	—	59	59	63	67	73	101	—	—	2	2	2	2	1.69	
110		40	2	2	65	—	203	187	28.6	4 900	7 400	NU2310R	NJ2310R	NUP2310R	—	—	59	59	63	67	73	101	—	—	2	2	2	2	1.76	
110		44.4	2	2	65	—	195	183	27.3	5 000	7 500	NU3310	—	—	—	—	59	59	63	67	—	101	—	—	2	2	2	2	2.14	
130		31	2.1	2.1	70.8	110.8	161	136	17.4	4 900	6 600	NU410	NJ410	NUP410	N410	NF410	61	61	69	73	81	119	119	112	2	2	2	2	2.01	
55	90	18	1.1	1	64.5	—	47.1	43.8	5.75	7 600	8 900	NU1011	—	—	NUP1011	—	—	61.5	60	63	66	—	83.5	—	—	1	1	1	1	0.445
	100	21	1.5	1.1	—	88.5	72.5	62.3	8.30	6 400	7 700	—	—	—	N211	NF211	63	—	—	—	73	92	93.5	91	1.5	1	1	1	(0.633)	
	100	21	1.5	1.1	66	—	108	98.7	14.2	6 400	7 700	NU211R	NJ211R	NUP211R	—	—	63	61.5	65	68	73	92	—	—	1.5	1	1	1	0.650	
	100	25	1.5	1.1	66.5	—	94.2	87.2	11.6	5 800	7 700	NU2211	NJ2211	NUP2211	—	—	63	61.5	65	68	73	92	—	—	1.5	1	1	1	0.780	

[Remarks] 1) Standard cage types used for the above bearings are shown in Table 1 earlier in this section. Please note that basic load ratings and limiting speeds shown above indicate the value applicable to machined cage. Consult JTEKT about bearings with pressed cage, since they may be different from bearings with machined cage in values above.

2) Bearing numbers of NU and NJ type bearings with mounted thrust collar (refer to specification table shown after this specification table) are NUJ and NH.

Single-row cylindrical roller bearings

d (55) ~ (65) mm



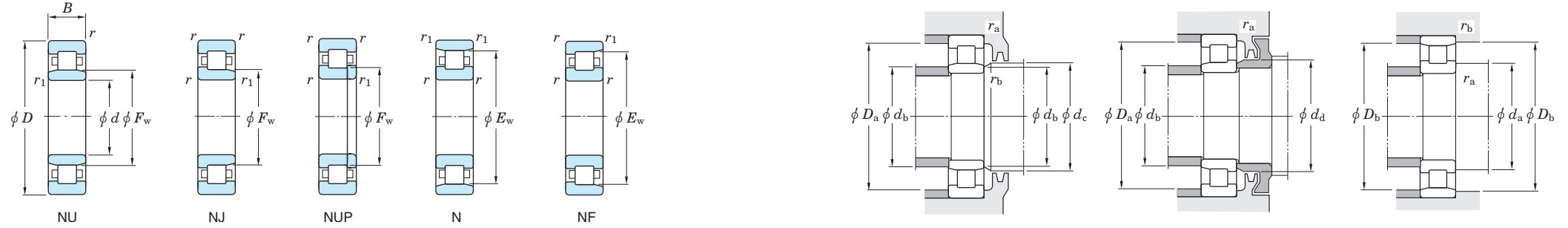
Boundary dimensions (mm)			Basic load ratings (kN)		Fatigue load limit (kN) $C_u$	Limiting speeds (min <sup>-1</sup> )		Bearing No.					Mounting dimensions (mm)										(Refer.) Mass NU (kg)				
d	D	B	r min.	r1 min.		$F_w$	$E_w$	$C_r$	$C_{0r}$	Grease lub.	Oil lub.	NU	NJ	NUP	N	NF	$d_a$ min.	$d_b$ min.	$d_b$ max.	$d_c$ min.	$d_d$ min.	$D_a$ max.		$D_b$ max.	$r_a$ min.	$r_b$ max.	$r_a$ max.
55	100	25	1.5	1.1	66	—	127	122	16.9	5 800	7 700	NU2211R	NJ2211R	NUP2211R	—	—	63	61.5	65	68	73	92	—	—	1.5	1	0.806
	100	33.3	1.5	1.5	66.5	—	119	118	16.1	5 100	7 700	NU3211	—	—	—	—	63	63	65	68	—	92	—	—	1.5	1	1.14
	120	29	2	2	—	104.5	138	111	15.8	5 100	6 800	—	—	—	N311	NF311	64	—	—	—	80	111	111	107	2	2	(1.44)
	120	29	2	2	70.5	—	172	143	19.8	5 100	6 700	NU311R	NJ311R	NUP311R	—	—	64	64	69	72	80	111	—	—	2	2	1.50
	120	43	2	2	70.5	—	185	162	24.6	4 500	6 800	NU2311	NJ2311	NUP2311	—	—	64	64	69	72	80	111	—	—	2	2	2.10
	120	43	2	2	70.5	—	251	233	35.3	4 500	6 700	NU2311R	NJ2311R	NUP2311R	—	—	64	64	69	72	80	111	—	—	2	2	2.25
	120	49.2	2	2	70.5	—	235	220	32.8	4 500	6 800	NU3311	—	—	—	—	64	64	69	72	—	111	—	—	2	2	2.81
	140	33	2.1	2.1	77.2	117.2	174	138	19.6	4 600	6 100	NU411	NJ411	NUP411	N411	NF411	66	66	76	79	87	129	129	119	2	2	2.51
60	95	18	1.1	1	69.5	—	53.0	50.0	6.75	7 000	8 300	NU1012	—	NUP1012	—	—	66.5	65	68	71	—	88.5	—	—	1	1	0.477
	110	22	1.5	1.5	—	97.5	85.7	79.9	10.4	5 800	7 000	—	—	—	N212	NF212	68	—	—	—	80	102	102	100	1.5	1.5	(0.823)
	110	22	1.5	1.5	72	—	122	107	15.7	5 800	6 900	NU212R	NJ212R	NUP212R	—	—	68	68	71	75	80	102	—	—	1.5	1.5	0.830
	110	28	1.5	1.5	73.5	—	120	123	15.3	5 200	7 000	NU2212	NJ2212	NUP2212	—	—	68	68	71	75	80	102	—	—	1.5	1.5	1.07
	110	28	1.5	1.5	72	—	164	157	21.7	5 200	6 900	NU2212R	NJ2212R	NUP2212R	—	—	68	68	71	75	80	102	—	—	1.5	1.5	1.09
	110	36.5	1.5	1.5	73.5	—	160	167	24.7	4 700	7 000	NU3212	—	—	—	—	68	68	71	75	—	102	—	—	1.5	1.5	1.52
	130	31	2.1	2.1	—	113	155	126	17.3	4 700	6 300	—	—	—	N312	NF312	71	—	—	—	86	119	119	116	2	2	(1.83)
	130	31	2.1	2.1	77	—	187	157	22.1	4 600	6 200	NU312R	NJ312R	NUP312R	—	—	71	71	75	79	86	119	—	—	2	2	1.87
	130	46	2.1	2.1	77	—	211	188	29.4	4 200	6 300	NU2312	NJ2312	NUP2312	—	—	71	71	75	79	86	119	—	—	2	2	2.69
	130	46	2.1	2.1	77	—	278	262	39.6	4 100	6 200	NU2312R	NJ2312R	NUP2312R	—	—	71	71	75	79	86	119	—	—	2	2	2.81
	130	54	2.1	2.1	77	—	275	265	39.9	4 200	6 300	NU3312	—	—	—	—	71	71	75	79	—	119	—	—	2	2	3.61
	150	35	2.1	2.1	83	127	209	184	26.1	4 200	5 700	NU412	NJ412	NUP412	N412	NF412	71	71	82	85	94	139	139	128	2	2	3.02
65	100	18	1.1	1	74.5	—	54.4	52.9	7.15	6 600	7 800	NU1013	—	NUP1013	—	—	71.5	70	73	76	—	93.5	—	—	1	1	0.506
	120	23	1.5	1.5	—	105.6	105	94.4	13.5	5 400	6 400	—	—	—	N213	NF213	73	—	—	—	87	112	112	108	1.5	1.5	(1.05)
	120	23	1.5	1.5	78.5	—	134	119	16.1	5 300	6 400	NU213R	NJ213R	NUP213R	—	—	73	73	77	81	87	112	—	—	1.5	1.5	1.05
	120	31	1.5	1.5	79.6	—	150	149	20.6	4 800	6 400	NU2213	NJ2213	NUP2213	—	—	73	73	77	81	87	112	—	—	1.5	1.5	1.43
	120	31	1.5	1.5	78.5	—	186	181	27.7	4 800	6 400	NU2213R	NJ2213R	NUP2213R	—	—	73	73	77	81	87	112	—	—	1.5	1.5	1.45
	120	38.1	1.5	1.5	79.6	—	186	197	29.7	4 300	6 400	NU3213	—	—	—	—	73	73	77	81	—	112	—	—	1.5	1.5	1.90
	140	33	2.1	2.1	—	121.5	169	139	19.2	4 300	5 800	—	—	—	N313	NF313	76	—	—	—	93	129	129	125	2	2	(2.19)

[Remarks] 1) Standard cage types used for the above bearings are shown in Table 1 earlier in this section. Please note that basic load ratings and limiting speeds shown above indicate the value applicable to machined cage. Consult JTEKT about bearings with pressed cage, since they may be different from bearings with machined cage in values above.

2) Bearing numbers of NU and NJ type bearings with mounted thrust collar (refer to specification table shown after this specification table) are NUJ and NH.

Single-row cylindrical roller bearings

d (65) ~ (75) mm



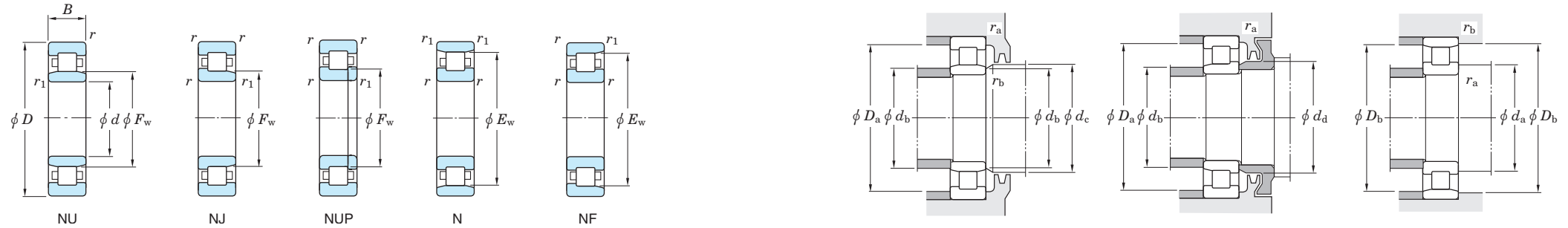
Boundary dimensions (mm)							Basic load ratings (kN)		Fatigue load limit (kN) $C_u$	Limiting speeds (min <sup>-1</sup> )		Bearing No.					Mounting dimensions (mm)								(Refer.) Mass NU (N) (kg)		
d	D	B	r min.	r <sub>1</sub> min.	F <sub>w</sub>	E <sub>w</sub>	C <sub>r</sub>	C <sub>0r</sub>		Grease lub.	Oil lub.	NU	NJ	NUP	N	NF	d <sub>a</sub> min.	d <sub>b</sub> min.	d <sub>b</sub> max.	d <sub>c</sub> min.	d <sub>d</sub> min.	D <sub>a</sub> max.	D <sub>b</sub> max.	r <sub>a</sub> min.		r <sub>b</sub> max.	
65	140	33	2.1	2.1	82.5	—	226	191	29.8	4 300	5 700	NU313R	NJ313R	NUP313R	—	—	76	76	81	85	93	129	—	—	2	2	2.31
	140	48	2.1	2.1	83.5	—	235	212	32.9	3 900	5 800	NU2313	NJ2313	NUP2313	—	—	76	76	81	85	93	129	—	—	2	2	3.25
	140	48	2.1	2.1	82.5	—	310	287	43.3	3 800	5 700	NU2313R	NJ2313R	NUP2313R	—	—	76	76	81	85	93	129	—	—	2	2	3.36
	140	58.7	2.1	2.1	83.5	—	302	294	43.9	3 900	5 800	NU3313	—	—	—	—	76	76	81	85	—	129	—	—	2	2	4.53
	160	37	2.1	2.1	89.3	135.3	228	203	28.2	4 000	5 300	NU413	NJ413	NUP413	N413	NF413	76	76	88	91	100	149	149	137	2	2	3.58
70	110	20	1.1	1	80	—	72.9	70.4	10.1	6 100	7 200	NU1014	—	NUP1014	—	—	76.5	75	78	82	—	103.5	—	—	1	1	0.702
	125	24	1.5	1.5	—	110.5	104	95.2	13.6	5 100	6 100	—	—	—	N214	NF214	78	—	—	—	92	117	117	114	1.5	1.5	(1.15)
	125	24	1.5	1.5	83.5	—	148	137	19.0	5 000	6 000	NU214R	NJ214R	NUP214R	—	—	78	78	82	86	92	117	—	—	1.5	1.5	1.16
	125	31	1.5	1.5	84.5	—	149	151	20.8	4 600	6 100	NU2214	NJ2214	NUP2214	—	—	78	78	82	86	92	117	—	—	1.5	1.5	1.52
	125	31	1.5	1.5	83.5	—	194	194	29.8	4 500	6 000	NU2214R	NJ2214R	NUP2214R	—	—	78	78	82	86	92	117	—	—	1.5	1.5	1.53
	125	39.7	1.5	1.5	84.5	—	185	198	30.0	4 100	6 100	NU3214	—	—	—	—	78	78	82	86	—	117	—	—	1.5	1.5	2.09
	150	35	2.1	2.1	—	130	198	168	23.3	4 000	5 400	—	—	—	N314	NF314	81	—	—	—	100	139	139	134	2	2	(2.73)
	150	35	2.1	2.1	89	—	256	222	33.4	4 000	5 300	NU314R	NJ314R	NUP314R	—	—	81	81	87	92	100	139	—	—	2	2	2.81
	150	51	2.1	2.1	90	—	279	262	39.3	3 600	5 400	NU2314	NJ2314	NUP2314	—	—	81	81	87	92	100	139	—	—	2	2	3.97
	150	51	2.1	2.1	89	—	342	323	47.1	3 600	5 300	NU2314R	NJ2314R	NUP2314R	—	—	81	81	87	92	100	139	—	—	2	2	4.08
	150	63.5	2.1	2.1	90	—	354	356	51.5	3 600	5 400	NU3314	—	—	—	—	81	81	87	92	—	139	—	—	2	2	5.62
	180	42	3	3	100	152	285	257	35.2	3 500	4 700	NU414	NJ414	NUP414	N414	NF414	83	83	99	102	112	167	167	153	2.5	2.5	5.26
	75	115	20	1.1	1	85	—	80.0	78.1	10.2	5 700	6 800	NU1015	—	NUP1015	—	—	81.5	80	83	87	—	108.5	—	—	1	1
130		25	1.5	1.5	—	116.5	121	118	16.1	4 800	5 800	—	—	—	N215	NF215	83	—	—	—	96	122	122	120	1.5	1.5	(1.24)
130		25	1.5	1.5	88.5	—	163	156	21.9	4 800	5 700	NU215R	NJ215R	NUP215R	—	—	83	83	87	90	96	122	—	—	1.5	1.5	1.29
130		31	1.5	1.5	88.5	—	162	172	22.3	4 300	5 800	NU2215	NJ2215	NUP2215	—	—	83	83	87	90	96	122	—	—	1.5	1.5	1.57
130		31	1.5	1.5	88.5	—	202	207	31.5	4 300	5 700	NU2215R	NJ2215R	NUP2215R	—	—	83	83	87	90	96	122	—	—	1.5	1.5	1.61
130		41.3	1.5	1.5	88.5	—	210	226	34.1	3 900	5 800	NU3215	—	—	—	—	83	83	87	90	—	122	—	—	1.5	1.5	2.28
160		37	2.1	2.1	—	139.5	224	205	28.4	3 800	5 000	—	—	—	N315	NF315	86	—	—	—	106	149	149	143	2	2	(3.19)
160		37	2.1	2.1	95	—	300	263	39.9	3 700	5 000	NU315R	NJ315R	NUP315R	—	—	86	86	93	97	106	149	—	—	2	2	3.37
160		55	2.1	2.1	95.5	—	323	327	43.4	3 400	5 000	NU2315	NJ2315	NUP2315	—	—	86	86	93	97	106	149	—	—	2	2	4.84
160		55	2.1	2.1	95	—	412	395	57.3	3 300	5 000	NU2315R	NJ2315R	NUP2315R	—	—	86	86	93	97	106	149	—	—	2	2	5.00

[Remarks] 1) Standard cage types used for the above bearings are shown in Table 1 earlier in this section. Please note that basic load ratings and limiting speeds shown above indicate the value applicable to machined cage. Consult JTEKT about bearings with pressed cage, since they may be different from bearings with machined cage in values above.

2) Bearing numbers of NU and NJ type bearings with mounted thrust collar (refer to specification table shown after this specification table) are NUJ and NH.

Single-row cylindrical roller bearings

d (75) ~ (90) mm



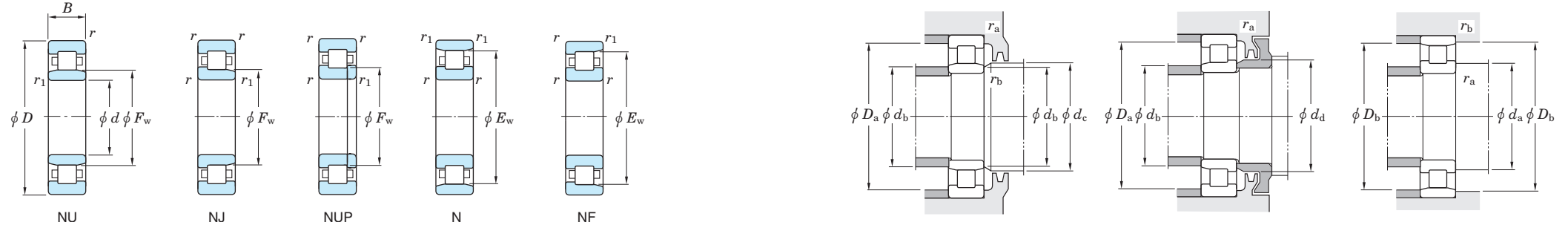
Boundary dimensions (mm)								Basic load ratings (kN)		Fatigue load limit (kN) $C_u$	Limiting speeds (min <sup>-1</sup> )		Bearing No.					Mounting dimensions (mm)								(Refer.) Mass NU (N) (kg)		
d	D	B	r min.	r1 min.	Fw	Ew	Cr	C0r	Grease lub.		Oil lub.	NU	NJ	NUP	N	NF	da min.	db min.	db max.	dc min.	dd min.	Da max.	Db max.	rb min.	ra max.		rb max.	
75	160	68.3	2.1	2.1	95.5	—	423	430	62.1	3 400	5 000	NU3315	—	—	—	86	86	93	97	—	149	—	—	2	2	6.86		
	190	45	3	3	104.5	160.5	328	274	40.2	3 300	4 400	NU415	NJ415	NUP415	N415	NF415	88	88	103	107	118	177	177	162	2.5	2.5	6.25	
80	125	22	1.1	1	91.5	—	87.2	86.4	11.5	5 300	6 300	NU1016	—	NUP1016	—	—	86.5	85	90	94	—	118.5	—	—	1	1	0.994	
	140	26	2	2	—	125.3	133	122	16.2	4 500	5 400	—	—	—	N216	NF216	89	—	—	—	104	131	131	128	2	2	(1.51)	
	140	26	2	2	95.3	—	174	167	23.0	4 400	5 300	NU216R	NJ216R	NUP216R	—	—	89	89	94	97	104	131	—	—	2	2	1.56	
	140	33	2	2	95.3	—	184	186	27.8	4 000	5 400	NU2216	NJ2216	NUP2216	—	—	89	89	94	97	104	131	—	—	2	2	1.96	
	140	33	2	2	95.3	—	233	243	35.8	4 000	5 300	NU2216R	NJ2216R	NUP2216R	—	—	89	89	94	97	104	131	—	—	2	2	2.03	
	140	44.4	2	2	95.3	—	238	259	37.8	3 600	5 400	NU3216	—	—	—	—	89	89	94	97	—	131	—	—	2	2	2.87	
	170	39	2.1	2.1	—	147	—	238	207	30.7	3 500	4 700	—	—	—	N316	NF316	91	—	—	—	114	159	159	151	2	2	(3.83)
	170	39	2.1	2.1	101	—	—	320	282	42.1	3 500	4 700	NU316R	NJ316R	NUP316R	—	—	91	91	99	105	114	159	—	—	2	2	4.00
	170	58	2.1	2.1	103	—	—	343	332	46.9	3 100	4 700	NU2316	NJ2316	NUP2316	—	—	91	91	99	105	114	159	—	—	2	2	5.83
	170	58	2.1	2.1	101	—	—	445	431	61.1	3 100	4 700	NU2316R	NJ2316R	NUP2316R	—	—	91	91	99	105	114	159	—	—	2	2	5.95
	170	68.3	2.1	2.1	103	—	—	423	436	61.9	3 100	4 700	NU3316	—	—	—	—	91	91	99	105	—	159	—	—	2	2	7.72
	200	48	3	3	110	170	—	374	315	45.2	3 100	4 200	NU416	NJ416	NUP416	N416	NF416	93	93	109	112	124	187	187	172	2.5	2.5	7.28
85	130	22	1.1	1	96.5	—	89.8	91.2	12.0	5 100	6 000	NU1017	—	NUP1017	—	—	91.5	90	95	99	—	123.5	—	—	1	1	1.04	
	150	28	2	2	—	133.8	151	140	18.7	4 200	5 000	—	—	—	N217	NF217	94	—	—	—	110	141	141	137	2	2	(1.90)	
	150	28	2	2	100.5	—	209	199	26.3	4 200	5 000	NU217R	NJ217R	NUP217R	—	—	94	94	99	104	110	141	—	—	2	2	1.94	
	150	36	2	2	101.8	—	212	218	31.6	3 800	5 000	NU2217	NJ2217	NUP2217	—	—	94	94	99	104	110	141	—	—	2	2	2.50	
	150	36	2	2	100.5	—	272	279	41.6	3 700	5 000	NU2217R	NJ2217R	NUP2217R	—	—	94	94	99	104	110	141	—	—	2	2	2.53	
	150	49.2	2	2	101.8	—	269	296	42.1	3 300	5 000	NU3217	—	—	—	—	94	94	99	104	—	141	—	—	2	2	3.67	
	180	41	3	3	—	156	—	281	247	35.6	3 300	4 500	—	—	—	N317	NF317	98	—	—	—	119	167	167	160	2.5	2.5	(4.52)
	180	41	3	3	108	—	—	364	330	48.3	3 300	4 400	NU317R	NJ317R	NUP317R	—	—	98	98	106	110	119	167	—	—	2.5	2.5	4.80
	180	60	3	3	108	—	—	394	382	54.2	3 000	4 500	NU2317	NJ2317	NUP2317	—	—	98	98	106	110	119	167	—	—	2.5	2.5	6.62
	180	60	3	3	108	—	—	491	485	67.7	2 900	4 400	NU2317R	NJ2317R	NUP2317R	—	—	98	98	106	110	119	167	—	—	2.5	2.5	6.98
	180	73	3	3	108	—	—	499	517	71.5	3 000	4 500	NU3317	—	—	—	—	98	98	106	110	—	167	—	—	2.5	2.5	9.23
	210	52	4	4	113	177	—	416	350	49.7	3 000	4 000	NU417	NJ417	NUP417	N417	NF417	101	101	111	115	128	194	194	179	3	3	8.68
90	140	24	1.5	1.1	103	—	106	109	14.6	4 700	5 600	NU1018	—	NUP1018	—	—	98	96.5	101	106	—	132	—	—	1.5	1	1.34	

[Remarks] 1) Standard cage types used for the above bearings are shown in Table 1 earlier in this section. Please note that basic load ratings and limiting speeds shown above indicate the value applicable to machined cage. Consult JTEKT about bearings with pressed cage, since they may be different from bearings with machined cage in values above.

2) Bearing numbers of NU and NJ type bearings with mounted thrust collar (refer to specification table shown after this specification table) are NUJ and NH.

Single-row cylindrical roller bearings

d (90) ~ (100) mm



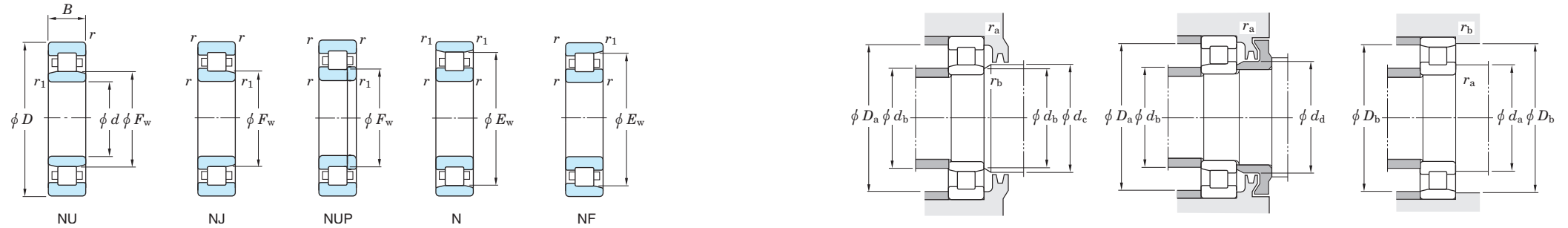
d	Boundary dimensions (mm)						Basic load ratings (kN)		Fatigue load limit (kN) Cu	Limiting speeds (min <sup>-1</sup> )		Bearing No.					Mounting dimensions (mm)								(Refer.) Mass NU (N) (kg)			
	D	B	r min.	r1 min.	Fw	Ew	Cr	C0r		Grease lub.	Oil lub.	NU	NJ	NUP	N	NF	da min.	db min.	db max.	dc min.	dd min.	Da max.	Db max.	ra min.		ra max.	rb min.	rb max.
90	160	30	2	2	—	143	190	178	22.9	3 900	4 700	—	—	—	—	—	—	—	—	116	151	151	146	2	2	2	(2.32)	
	160	30	2	2	107	—	227	217	28.7	3 900	4 700	NU218R	NJ218R	NUP218R	—	—	99	99	105	109	116	151	—	—	2	2	2.38	
	160	40	2	2	107	—	259	265	38.9	3 500	4 700	NU2218	NJ2218	NUP2218	—	—	99	99	105	109	116	151	—	—	2	2	3.10	
	160	40	2	2	107	—	302	314	45.8	3 500	4 700	NU2218R	NJ2218R	NUP2218R	—	—	99	99	105	109	116	151	—	—	2	2	3.21	
	160	52.4	2	2	107	—	338	373	52.8	3 100	4 700	NU3218	—	—	—	—	99	99	105	109	—	151	—	—	2	2	4.49	
	190	43	3	3	—	165	300	265	38.7	3 100	4 200	—	—	—	N318	NF318	103	—	—	—	127	177	177	169	2.5	2.5	(5.27)	
	190	43	3	3	113.5	—	395	355	50.6	3 100	4 100	NU318R	NJ318R	NUP318R	—	—	103	103	111	117	127	177	—	—	2.5	2.5	5.47	
	190	64	3	3	115	—	408	395	55.5	2 800	4 200	NU2318	NJ2318	NUP2318	—	—	103	103	111	117	127	177	—	—	2.5	2.5	7.90	
	190	64	3	3	113.5	—	544	534	74.5	2 800	4 100	NU2318R	NJ2318R	NUP2318R	—	—	103	103	111	117	127	177	—	—	2.5	2.5	8.12	
	190	73	3	3	115	—	535	559	75.6	2 800	4 200	NU3318	—	—	—	—	103	103	111	117	—	177	—	—	2.5	2.5	10.3	
	225	54	4	4	123.5	191.5	468	400	55.1	2 800	3 700	NU418	NJ418	NUP418	N418	NF418	106	106	122	125	139	209	209	194	3	3	10.3	
	95	145	24	1.5	1.1	108	—	110	115	15.2	4 500	5 300	NU1019	—	NUP1019	—	—	103	101.5	106	111	—	137	—	—	1.5	1	1.40
		170	32	2.1	2.1	—	151.5	207	195	25.1	3 700	4 400	—	—	—	N219	NF219	106	—	—	—	123	159	159	155	2	2	(2.80)
170		32	2.1	2.1	112.5	—	275	265	38.3	3 700	4 400	NU219R	NJ219R	NUP219R	—	—	106	106	111	116	123	159	—	—	2	2	2.92	
170		43	2.1	2.1	113.5	—	288	298	42.9	3 300	4 400	NU2219	NJ2219	NUP2219	—	—	106	106	111	116	123	159	—	—	2	2	3.85	
170		43	2.1	2.1	112.5	—	358	371	52.8	3 300	4 400	NU2219R	NJ2219R	NUP2219R	—	—	106	106	111	116	123	159	—	—	2	2	3.93	
170		55.6	2.1	2.1	113.5	—	371	412	57.2	3 000	4 400	NU3219	—	—	—	—	106	106	111	116	—	159	—	—	2	2	5.42	
200		45	3	3	—	173.5	323	311	41.3	3 000	4 000	—	—	—	N319	NF319	108	—	—	—	134	187	187	178	2.5	2.5	(6.10)	
200		45	3	3	121.5	—	418	387	54.3	2 900	3 900	NU319R	NJ319R	NUP319R	—	—	108	108	119	124	134	187	—	—	2.5	2.5	6.42	
200		67	3	3	121.5	—	465	496	62.6	2 600	4 000	NU2319	NJ2319	NUP2319	—	—	108	108	119	124	134	187	—	—	2.5	2.5	9.39	
200		77.8	3	3	121.5	—	609	654	86.8	2 600	4 000	NU3319	—	—	—	—	108	108	119	124	—	187	—	—	2.5	2.5	12.1	
240	55	4	4	133.5	201.5	502	444	60.1	2 600	3 400	NU419	NJ419	NUP419	N419	NF419	111	111	132	136	149	224	224	204	3	3	13.6		
100	150	24	1.5	1.1	113	—	114	120	15.8	4 300	5 100	NU1020	—	NUP1020	—	—	108	106.5	111	116	—	142	—	—	1.5	1	1.46	
	180	34	2.1	2.1	—	160	229	217	28.1	3 500	4 200	—	—	—	N220	NF220	111	—	—	—	130	169	169	164	2	2	(3.38)	
	180	34	2.1	2.1	119	—	312	306	43.0	3 500	4 200	NU220R	NJ220R	NUP220R	—	—	111	111	117	122	130	169	—	—	2	2	3.52	
	180	46	2.1	2.1	120	—	322	338	47.3	3 100	4 200	NU2220	NJ2220	NUP2220	—	—	111	111	117	122	130	169	—	—	2	2	4.67	
	180	46	2.1	2.1	119	—	417	444	60.7	3 100	4 200	NU2220R	NJ2220R	NUP2220R	—	—	111	111	117	122	130	169	—	—	2	2	4.82	

[Remarks] 1) Standard cage types used for the above bearings are shown in Table 1 earlier in this section. Please note that basic load ratings and limiting speeds shown above indicate the value applicable to machined cage. Consult JTEKT about bearings with pressed cage, since they may be different from bearings with machined cage in values above.

2) Bearing numbers of NU and NJ type bearings with mounted thrust collar (refer to specification table shown after this specification table) are NUJ and NH.

Single-row cylindrical roller bearings

d (100) ~ (120) mm



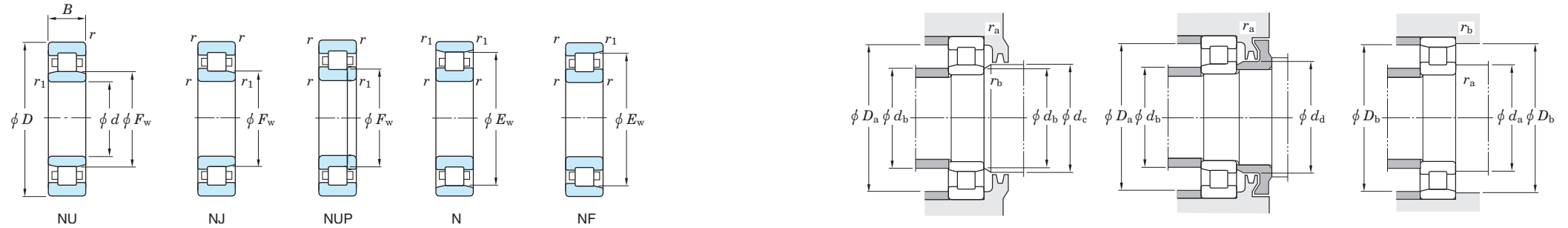
Boundary dimensions (mm)								Basic load ratings (kN)		Fatigue load limit (kN) C <sub>u</sub>	Limiting speeds (min <sup>-1</sup> )		Bearing No.					Mounting dimensions (mm)								(Refer.) Mass NU (N) (kg)	
d	D	B	r min.	r <sub>1</sub> min.	F <sub>w</sub>	E <sub>w</sub>	C <sub>r</sub>	C <sub>0r</sub>	Grease lub.		Oil lub.	NU	NJ	NUP	N	NF	d <sub>a</sub> min.	d <sub>b</sub> min. max.	d <sub>c</sub> min.	d <sub>d</sub> min.	D <sub>a</sub> max.	D <sub>b</sub> max. min.	r <sub>a</sub> max.	r <sub>b</sub> max.			
100	180	60.3	2.1	2.1	120	—	409	459	61.9	2 800	4 200	NU3220	—	—	—	111	111	117	122	—	169	—	—	2	2	6.62	
	215	47	3	3	—	185.5	373	337	47.2	2 800	3 700	—	—	N320	NF320	113	—	—	—	143	202	202	190	2.5	2.5	(7.59)	
	215	47	3	3	127.5	—	474	424	58.7	2 700	3 600	NU320R	NJ320R	NUP320R	—	113	113	125	132	143	202	—	—	2.5	2.5	7.75	
	215	73	3	3	129.5	—	513	548	68.4	2 500	3 700	NU2320	NJ2320	NUP2320	—	113	113	125	132	143	202	—	—	2.5	2.5	11.9	
	215	73	3	3	127.5	—	713	717	94.7	2 400	3 600	NU2320R	NJ2320R	NUP2320R	—	113	113	125	132	143	202	—	—	2.5	2.5	12.1	
	215	82.6	3	3	129.5	—	663	706	93.2	2 500	3 700	NU3320	—	—	—	113	113	125	132	—	202	—	—	2.5	2.5	15.0	
	250	58	4	4	139	211	560	498	67.3	2 500	3 300	NU420	NJ420	NUP420	N420	NF420	116	116	137	141	156	234	213	3	3	14.0	
	105	160	26	2	1.1	119.5	—	136	149	19.6	4 100	4 800	NU1021	—	NUP1021	—	114	111.5	118	122	—	151	—	—	2	1	1.85
190		36	2.1	2.1	—	168.8	251	241	34.1	3 300	3 900	—	—	N221	NF221	116	—	—	—	137	179	179	173	2	2	(4.44)	
190		65.1	2.1	2.1	126.8	—	431	482	64.3	2 600	3 900	NU3221	—	—	—	116	116	124	129	—	179	—	—	2	2	8.00	
225		49	3	3	—	195	426	417	53.1	2 600	3 500	—	—	N321	NF321	118	—	—	—	149	212	212	199	2.5	2.5	(8.68)	
225		77	3	3	135	—	711	750	97.3	2 300	3 500	NU2321	—	NUP2321	—	118	118	131	138	—	212	—	—	2.5	2.5	15.6	
225		87.3	3	3	135	—	799	871	113	2 300	3 500	NU3321	—	—	—	118	118	132	137	—	212	—	—	2.5	2.5	17.4	
260		60	4	4	144.5	220.5	581	510	67.6	2 400	3 100	NU421	NJ421	NUP421	N421	NF421	121	121	143	147	162	244	244	223	3	3	19.1
110		170	28	2	1.1	125	—	168	171	21.7	3 800	4 500	NU1022	—	NUP1022	—	119	116.5	124	128	—	161	—	—	2	1	2.31
	200	38	2.1	2.1	—	178.5	300	290	40.1	3 100	3 700	—	—	N222	NF222	121	—	—	—	144	189	189	182	2	2	(5.24)	
	200	38	2.1	2.1	132.5	—	366	365	51.1	3 100	3 700	NU222R	NJ222R	NUP222R	—	121	121	130	135	144	189	—	—	2	2	4.90	
	200	53	2.1	2.1	132.5	—	397	442	55.1	2 800	3 700	NU2222	NJ2222	NUP2222	—	121	121	130	135	144	189	—	—	2	2	6.93	
	200	53	2.1	2.1	132.5	—	479	517	69.9	2 800	3 700	NU2222R	NJ2222R	NUP2222R	—	121	121	130	135	144	189	—	—	2	2	6.93	
	200	69.8	2.1	2.1	132.5	—	533	607	80.6	2 500	3 700	NU3222	—	—	—	121	121	130	135	—	189	—	—	2	2	9.55	
	240	50	3	3	—	207	475	467	58.4	2 500	3 300	—	—	—	N322	NF322	123	—	—	—	158	227	227	211	2.5	2.5	(10.4)
	240	50	3	3	143	—	564	525	70.0	2 400	3 200	NU322R	NJ322R	NUP322R	—	123	123	140	145	158	227	—	—	2.5	2.5	10.7	
	240	80	3	3	143	—	755	789	102	2 200	3 300	NU2322	NJ2322	NUP2322	—	123	123	140	145	158	227	—	—	2.5	2.5	18.8	
	240	80	3	3	143	—	843	880	112	2 200	3 200	NU2322R	NJ2322R	NUP2322R	—	123	123	140	145	158	227	—	—	2.5	2.5	18.8	
	240	92.1	3	3	143	—	849	918	118	2 200	3 300	NU3322	—	—	—	123	123	140	145	—	227	—	—	2.5	2.5	21.1	
	280	65	4	4	155	235	685	621	80.8	2 200	2 900	NU422	NJ422	NUP422	N422	NF422	126	126	153	157	173	264	264	237	3	3	19.9
	120	180	28	2	1.1	135	—	173	181	22.6	3 500	4 200	NU1024	—	NUP1024	—	129	126.5	134	138	—	171	—	—	2	1	2.47

[Remarks] 1) Standard cage types used for the above bearings are shown in Table 1 earlier in this section. Please note that basic load ratings and limiting speeds shown above indicate the value applicable to machined cage. Consult JTEKT about bearings with pressed cage, since they may be different from bearings with machined cage in values above.

2) Bearing numbers of NU and NJ type bearings with mounted thrust collar (refer to specification table shown after this specification table) are NUJ and NH.

Single-row cylindrical roller bearings

d (120) ~ (140) mm



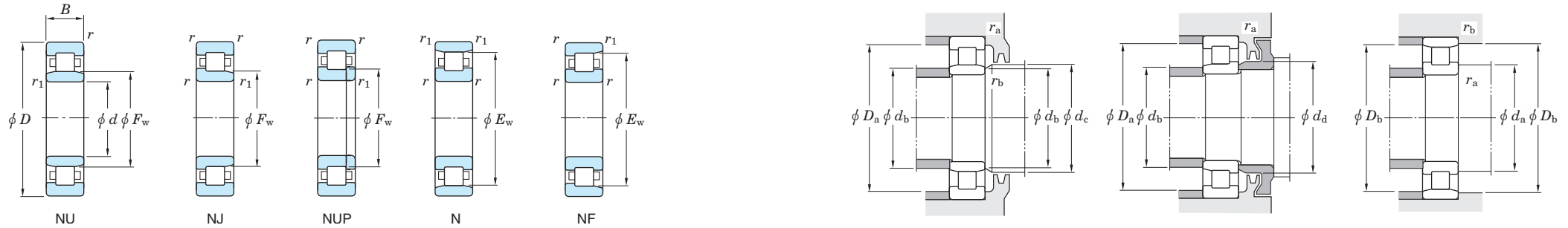
Boundary dimensions (mm)							Basic load ratings (kN)		Fatigue load limit (kN)	Limiting speeds (min <sup>-1</sup> )		Bearing No.					Mounting dimensions (mm)										(Refer.) Mass		
d	D	B	r min.	r1 min.	Fw	Ew	Cr	C0r	Cu	Grease lub.	Oil lub.	NU	NJ	NUP	N	NF	da min.	db min.	db max.	dc min.	dd min.	Da max.	Db max.	ra min.	rb max.	ra max.	rb max.	NU (N)	(kg)
120	215	40	2.1	2.1	—	191.5	325	318	42.9	2 900	3 400	—	—	—	N224	NF224	131	—	—	—	156	204	204	196	2	2	2	2	(6.31)
	215	40	2.1	2.1	143.5	—	419	421	57.6	2 800	3 400	NU224R	NJ224R	NUP224R	—	—	131	131	141	146	156	204	—	—	2	2	2	2	5.85
	215	58	2.1	2.1	143.5	—	434	492	61.2	2 600	3 400	NU224	NJ224	NUP224	—	—	131	131	141	146	156	204	—	—	2	2	2	2	8.56
	215	58	2.1	2.1	143.5	—	565	619	80.9	2 600	3 400	NU224R	NJ224R	NUP224R	—	—	131	131	141	146	156	204	—	—	2	2	2	2	8.56
	215	76	2.1	2.1	143.5	—	596	695	89.2	2 300	3 400	NU3224	—	—	—	—	131	131	141	146	—	204	—	—	2	2	2	2	11.9
	260	55	3	3	—	226	561	551	67.1	2 200	3 000	—	—	—	N324	NF324	133	—	—	—	171	247	247	230	2.5	2.5	2.5	2.5	(13.1)
	260	55	3	3	154	—	660	610	79.8	2 200	3 000	NU324R	NJ324R	NUP324R	—	—	133	133	151	156	171	247	—	—	2.5	2.5	2.5	2.5	13.4
	260	86	3	3	154	—	886	918	116	2 000	3 000	NU324	NJ324	NUP324	—	—	133	133	151	156	171	247	—	—	2.5	2.5	2.5	2.5	23.1
	260	86	3	3	154	—	991	1 030	129	2 000	3 000	NU324R	NJ324R	NUP324R	—	—	133	133	151	156	172	247	—	—	2.5	2.5	2.5	2.5	23.1
	260	106	3	3	154	—	1 030	1 120	139	2 000	3 000	NU3324	—	—	—	—	133	133	151	156	—	247	—	—	2.5	2.5	2.5	2.5	28.3
	310	72	5	5	170	260	841	770	98.7	1 900	2 600	NU424	NJ424	NUP424	N424	NF424	140	140	168	172	190	290	290	262	4	4	4	4	28.0
	130	200	33	2	1.1	148	—	215	238	29.5	3 200	3 800	NU1026	—	NUP1026	—	—	139	136.5	146	151	—	191	—	—	2	1	1	1
230		40	3	3	—	204	338	362	45.2	2 700	3 200	—	—	—	N226	NF226	143	—	—	—	168	217	217	208	2.5	2.5	2.5	2.5	(7.21)
230		40	3	3	153.5	—	454	453	61.0	2 600	3 200	NU226R	NJ226R	NUP226R	—	—	143	143	151	158	168	217	—	—	2.5	2.5	2.5	2.5	6.60
230		64	3	3	156	—	474	560	68.7	2 400	3 200	NU2226	NJ2226	NUP2226	—	—	143	143	151	158	168	217	—	—	2.5	2.5	2.5	2.5	11.2
230		64	3	3	153.5	—	662	737	95.8	2 400	3 200	NU2226R	NJ2226R	NUP2226R	—	—	143	143	151	158	168	217	—	—	2.5	2.5	2.5	2.5	11.2
230		80	3	3	156	—	689	857	107	2 100	3 200	NU3226	—	—	—	—	143	143	151	158	—	217	—	—	2.5	2.5	2.5	2.5	14.1
280		58	4	4	—	243	699	667	85.7	2 100	2 700	—	—	—	N326	NF326	146	—	—	—	184	264	264	247	3	3	3	3	(16.4)
280		58	4	4	167	—	771	736	94.1	2 000	2 700	NU326R	NJ326R	NUP326R	—	—	146	146	164	169	184	264	—	—	3	3	3	3	16.7
280		93	4	4	167	—	1 050	1 130	138	1 800	2 700	NU2326	NJ2326	NUP2326	—	—	146	146	164	169	184	264	—	—	3	3	3	3	29.1
280		93	4	4	167	—	1 150	1 230	150	1 800	2 700	NU2326R	NJ2326R	NUP2326R	—	—	146	146	164	169	186	264	—	—	3	3	3	3	29.1
280		112	4	4	167	—	1 170	1 290	158	1 800	2 700	NU3326	—	—	—	—	146	146	164	169	—	264	—	—	3	3	3	3	34.6
340		78	5	5	185	285	964	876	108	1 800	2 300	NU426	NJ426	NUP426	N426	NF426	150	150	183	187	208	320	320	287	4	4	4	4	36.1
140	210	33	2	1.1	158	—	220	250	30.5	3 000	3 600	NU1028	—	NUP1028	—	—	149	146.5	156	161	—	201	—	—	2	1	1	1	4.00
	250	42	3	3	—	221	406	421	55.5	2 400	2 900	—	—	—	N228	NF228	153	—	—	—	182	237	237	228	2.5	2.5	2.5	2.5	(8.78)
	250	42	3	3	169	—	491	514	67.5	2 400	2 900	NU228R	NJ228R	NUP228R	—	—	153	153	166	171	182	237	—	—	2.5	2.5	2.5	2.5	8.50
	250	68	3	3	169	—	583	671	84.3	2 200	2 900	NU2228	NJ2228	NUP2228	—	—	153	153	166	171	182	237	—	—	2.5	2.5	2.5	2.5	14.3
	250	68	3	3	169	—	716	835	106	2 200	2 900	NU2228R	NJ2228R	NUP2228R	—	—	153	153	166	171	182	237	—	—	2.5	2.5	2.5	2.5	14.3

[Remarks] 1) Standard cage types used for the above bearings are shown in Table 1 earlier in this section. Please note that basic load ratings and limiting speeds shown above indicate the value applicable to machined cage. Consult JTEKT about bearings with pressed cage, since they may be different from bearings with machined cage in values above.

2) Bearing numbers of NU and NJ type bearings with mounted thrust collar (refer to specification table shown after this specification table) are NUJ and NH.

Single-row cylindrical roller bearings

$d$  (140) ~ (160) mm



Boundary dimensions (mm)							Basic load ratings (kN)		Fatigue load limit (kN)	Limiting speeds (min <sup>-1</sup> )		Bearing No.					Mounting dimensions (mm)								(Refer.) Mass				
$d$	$D$	$B$	$r$ min.	$r_1$ min.	$F_w$	$E_w$	$C_r$	$C_{0r}$	$C_u$	Grease lub.	Oil lub.	NU	NJ	NUP	N	NF	$d_a$ min.	$d_b$ min.	$d_b$ max.	$d_c$ min.	$d_d$ min.	$d_d$ max.	$D_a$ max.	$D_b$ max.	$r_a$ min.	$r_b$ max.	$r_a$ max.	$r_b$ max.	NU (N) (kg)
140	250	88	3	3	169	—	757	939	114	1 900	2 900	NU3228	—	—	—	—	153	153	166	171	—	237	—	—	2.5	2.5	—	—	18.5
	300	62	4	4	—	260	771	746	93.8	1 900	2 500	—	—	—	N328	NF328	156	—	—	—	198	284	284	264	3	3	—	—	(21.8)
	300	62	4	4	180	—	829	797	99.4	1 900	2 500	NU328R	NJ328R	NUP328R	—	—	156	156	176	182	198	284	—	—	3	3	—	—	21.8
	300	102	4	4	180	—	1 150	1 250	150	1 700	2 500	NU2328	NJ2328	NUP2328	—	—	156	156	176	182	198	284	—	—	3	3	—	—	36.8
	300	102	4	4	180	—	1 270	1 380	167	1 700	2 500	NU2328R	NJ2328R	NUP2328R	—	—	156	156	176	182	200	284	—	—	3	3	—	—	36.8
	300	118	4	4	180	—	1 360	1 550	185	1 700	2 500	NU3328	—	—	—	—	156	156	176	182	—	284	—	—	3	3	—	—	41.5
	360	82	5	5	198	302	1 090	1 020	124	1 600	2 200	NU428	NJ428	NUP428	N428	NF428	160	160	195	200	222	340	340	304	4	4	—	—	46.8
150	225	35	2.1	1.5	169.5	—	252	281	32.8	2 800	3 300	NU1030	—	NUP1030	—	—	161	158	167	173	—	214	—	—	2	1.5	—	—	4.83
	270	45	3	3	—	238	468	492	63.4	2 200	2 700	—	—	—	N230	NF230	163	—	—	—	196	257	257	245	2.5	2.5	—	—	(11.1)
	270	45	3	3	182	—	560	594	75.8	2 200	2 600	NU230R	NJ230R	NUP230R	—	—	163	163	179	184	196	257	—	—	2.5	2.5	—	—	10.7
	270	73	3	3	182	—	683	800	99.7	2 000	2 700	NU2230	NJ2230	NUP2230	—	—	163	163	179	184	196	257	—	—	2.5	2.5	—	—	18.7
	270	73	3	3	182	—	828	982	120	2 000	2 600	NU2230R	NJ2230R	NUP2230R	—	—	163	163	179	184	196	257	—	—	2.5	2.5	—	—	18.7
	270	96	3	3	182	—	939	1 200	143	1 800	2 700	NU3230	—	—	—	—	163	163	179	184	—	257	—	—	2.5	2.5	—	—	23.7
	320	65	4	4	—	277	829	807	99.1	1 800	2 300	—	—	—	N330	NF330	166	—	—	—	213	304	304	281	3	3	—	—	(25.6)
	320	65	4	4	193	—	948	922	115	1 700	2 300	NU330R	NJ330R	NUP330R	—	—	166	166	190	195	213	304	—	—	3	3	—	—	27.0
	320	108	4	4	193	—	1 270	1 400	167	1 600	2 300	NU2330	NJ2330	NUP2330	—	—	166	166	190	195	213	304	—	—	3	3	—	—	44.7
	320	108	4	4	193	—	1 450	1 600	187	1 500	2 300	NU2330R	NJ2330R	NUP2330R	—	—	166	166	190	195	213	304	—	—	3	3	—	—	44.7
	320	128	4	4	193	—	1 610	1 890	217	1 600	2 300	NU3330	—	—	—	—	166	166	190	195	—	304	—	—	3	3	—	—	51.4
380	85	5	5	213	317	1 160	1 120	134	1 500	2 000	NU430	NJ430	NUP430	N430	NF430	170	170	210	216	237	360	360	319	4	4	—	—	53.3	
160	240	38	2.1	1.5	180	—	297	330	42.8	2 600	3 000	NU1032	—	NUP1032	—	—	171	168	178	184	—	229	—	—	2	1.5	—	—	5.93
	290	48	3	3	—	255	535	568	71.3	2 100	2 500	—	—	—	N232	NF232	173	—	—	—	210	277	277	262	2.5	2.5	—	—	(13.9)
	290	48	3	3	195	—	624	666	83.3	2 000	2 400	NU232R	NJ232R	NUP232R	—	—	173	173	192	197	210	277	—	—	2.5	2.5	—	—	14.8
	290	80	3	3	195	—	790	939	113	1 800	2 500	NU2232	NJ2232	NUP2232	—	—	173	173	192	197	210	277	—	—	2.5	2.5	—	—	23.6
	290	80	3	3	193	—	1 010	1 190	141	1 800	2 400	NU2232R	NJ2232R	NUP2232R	—	—	173	173	192	197	210	277	—	—	2.5	2.5	—	—	23.6
	290	104	3	3	195	—	1 070	1 390	163	1 600	2 500	NU3232	—	—	—	—	173	173	192	197	—	277	—	—	2.5	2.5	—	—	29.8
	340	68	4	4	—	292	872	876	106	1 600	2 200	—	—	—	N332	NF332	176	—	—	—	228	324	324	296	3	3	—	—	(30.2)
	340	68	4	4	204	—	1 070	1 050	128	1 600	2 100	NU332R	NJ332R	NUP332R	—	—	176	176	200	211	228	324	—	—	3	3	—	—	32.0

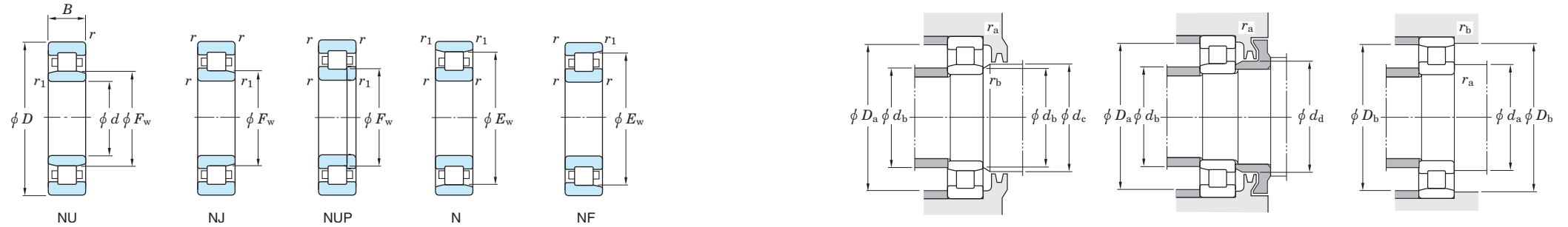
[Remarks] 1) Standard cage types used for the above bearings are shown in Table 1 earlier in this section. Please note that basic load ratings and limiting speeds shown above indicate the value applicable to machined cage. Consult JTEKT about bearings with pressed cage, since they may be different from bearings with machined cage in values above.

2) Bearing numbers of NU and NJ type bearings with mounted thrust collar (refer to specification table shown after this specification table) are NUJ and NH.



Single-row cylindrical roller bearings

d (160) ~ (190) mm



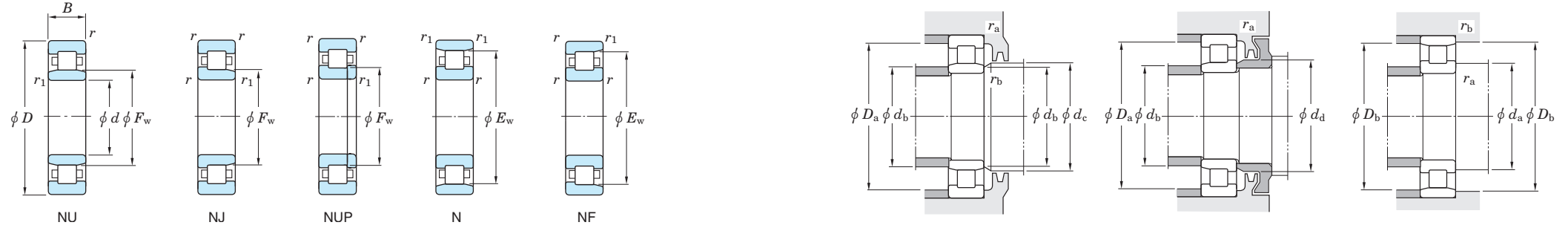
d	Boundary dimensions (mm)							Basic load ratings (kN)		Fatigue load limit (kN) $C_u$	Limiting speeds (min <sup>-1</sup> )		Bearing No.					Mounting dimensions (mm)							(Refer.) Mass NU (N) (kg)		
	D	B	r min.	r1 min.	Fw	Ew	Cr	C0r	Grease lub.		Oil lub.	NU	NJ	NUP	N	NF	da min.	db min.	db max.	dc min.	dd min.	Da max.	Db max.	rb min.		ra max.	rb max.
160	340	114	4	4	208	—	1 340	1 520	178	1 400	2 200	<b>NU2332</b>	<b>NJ2332</b>	<b>NUP2332</b>	—	—	176	176	200	211	228	324	—	—	3	3	53.1
	340	114	4	4	204	—	1 640	1 820	212	1 400	2 100	<b>NU2332R</b>	<b>NJ2332R</b>	<b>NUP2332R</b>	—	—	176	176	200	211	228	324	—	—	3	3	53.1
	340	136	4	4	208	—	1 590	1 890	216	1 400	2 200	<b>NU3332</b>	—	—	—	—	176	176	200	211	—	324	—	—	3	3	61.5
170	260	42	2.1	2.1	193	—	347	400	50.5	2 400	2 800	<b>NU1034</b>	—	<b>NUP1034</b>	—	—	181	181	190	197	—	249	—	—	2	2	7.90
	310	52	4	4	—	272	596	637	78.4	1 900	2 300	—	—	—	<b>N234</b>	<b>NF234</b>	186	—	—	—	223	294	294	280	3	3	(17.2)
	310	52	4	4	207	—	754	802	98.7	1 900	2 200	<b>NU234R</b>	<b>NJ234R</b>	<b>NUP234R</b>	—	—	186	186	204	211	223	294	—	—	3	3	18.6
	310	86	4	4	208	—	896	1 080	127	1 700	2 300	<b>NU2234</b>	<b>NJ2234</b>	<b>NUP2234</b>	—	—	186	186	204	211	223	294	—	—	3	3	29.2
	310	86	4	4	205	—	1 210	1 410	166	1 700	2 200	<b>NU2234R</b>	<b>NJ2234R</b>	<b>NUP2234R</b>	—	—	186	186	204	211	223	294	—	—	3	3	29.2
	310	110	4	4	208	—	1 210	1 580	181	1 500	2 300	<b>NU3234</b>	—	—	—	—	186	186	204	211	—	294	—	—	3	3	36.2
	360	72	4	4	220	310	997	1 010	122	1 500	2 000	<b>NU334</b>	<b>NJ334</b>	<b>NUP334</b>	<b>N334</b>	<b>NF334</b>	186	186	216	223	241	344	344	314	3	3	38.6
	360	120	4	4	220	—	1 530	1 750	199	1 300	2 000	<b>NU2334</b>	<b>NJ2334</b>	<b>NUP2334</b>	—	—	186	186	216	223	241	344	—	—	3	3	62.6
360	140	4	4	220	—	1 770	2 120	240	1 300	2 000	<b>NU3334</b>	—	—	—	—	186	186	216	223	—	344	—	—	3	3	70.8	
180	280	46	2.1	2.1	205	—	447	503	63.2	2 200	2 600	<b>NU1036</b>	—	<b>NUP1036</b>	—	—	191	191	203	209	—	269	—	—	2	2	10.5
	320	52	4	4	—	282	618	677	82.2	1 800	2 200	—	—	—	<b>N236</b>	<b>NF236</b>	196	—	—	—	233	304	304	290	3	3	(18.0)
	320	52	4	4	217	—	783	852	104	1 800	2 100	<b>NU236R</b>	<b>NJ236R</b>	<b>NUP236R</b>	—	—	196	196	214	221	233	304	—	—	3	3	19.3
	320	86	4	4	218	—	929	1 140	133	1 600	2 200	<b>NU2236</b>	<b>NJ2236</b>	<b>NUP2236</b>	—	—	196	196	214	221	233	304	—	—	3	3	30.4
	320	86	4	4	215	—	1 260	1 510	175	1 600	2 100	<b>NU2236R</b>	<b>NJ2236R</b>	<b>NUP2236R</b>	—	—	196	196	214	221	233	304	—	—	3	3	30.4
	320	112	4	4	218	—	1 250	1 680	190	1 400	2 200	<b>NU3236</b>	—	—	—	—	196	196	214	221	—	304	—	—	3	3	38.4
	380	75	4	4	232	328	1 130	1 150	136	1 400	1 900	<b>NU336</b>	<b>NJ336</b>	<b>NUP336</b>	<b>N336</b>	<b>NF336</b>	196	196	227	235	255	364	364	332	3	3	42.6
	380	126	4	4	232	—	1 690	1 940	220	1 300	1 900	<b>NU2336</b>	<b>NJ2336</b>	<b>NUP2336</b>	—	—	196	196	227	235	255	364	—	—	3	3	73.0
	380	150	4	4	232	—	2 070	2 520	276	1 300	1 900	<b>NU3336</b>	—	—	—	—	196	196	227	235	—	364	—	—	3	3	84.4
	190	290	46	2.1	2.1	215	—	460	530	65.7	2 100	2 500	<b>NU1038</b>	—	<b>NUP1038</b>	—	—	201	201	213	219	—	279	—	—	2	2
340		55	4	4	—	299	694	768	91.3	1 700	2 000	—	—	—	<b>N238</b>	<b>NF238</b>	206	—	—	—	247	324	324	310	3	3	(21.5)
340		55	4	4	230	—	869	954	114	1 700	2 000	<b>NU238R</b>	<b>NJ238R</b>	<b>NUP238R</b>	—	—	206	206	227	234	247	324	—	—	3	3	23.3
340		92	4	4	231	—	1 040	1 290	146	1 500	2 000	<b>NU2238</b>	<b>NJ2238</b>	<b>NUP2238</b>	—	—	206	206	227	234	247	324	—	—	3	3	37.0
340		92	4	4	228	—	1 380	1 670	189	1 500	2 000	<b>NU2238R</b>	<b>NJ2238R</b>	<b>NUP2238R</b>	—	—	206	206	227	234	247	324	—	—	3	3	37.0
340		120	4	4	231	—	1 420	1 930	226	1 300	2 000	<b>NU3238</b>	—	—	—	—	206	206	227	234	—	324	—	—	3	3	46.8

[Remarks] 1) Standard cage types used for the above bearings are shown in Table 1 earlier in this section. Please note that basic load ratings and limiting speeds shown above indicate the value applicable to machined cage. Consult JTEKT about bearings with pressed cage, since they may be different from bearings with machined cage in values above.

2) Bearing numbers of NU and NJ type bearings with mounted thrust collar (refer to specification table shown after this specification table) are NUJ and NH.

Single-row cylindrical roller bearings

d (190) ~ 240 mm



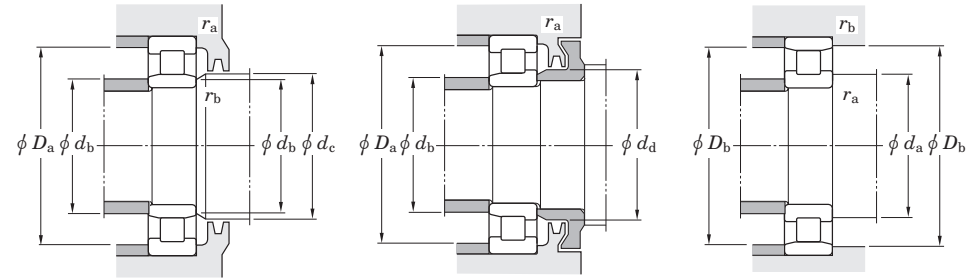
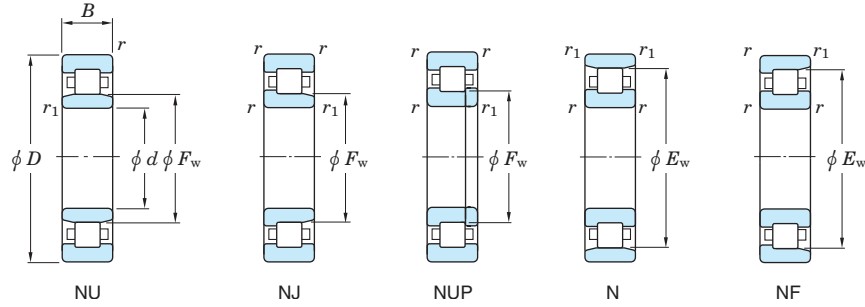
Boundary dimensions (mm)								Basic load ratings (kN)		Fatigue load limit (kN) Cu	Limiting speeds (min <sup>-1</sup> )		Bearing No.					Mounting dimensions (mm)								(Refer.) Mass NU (N) (kg)		
d	D	B	r min.	r1 min.	Fw	Ew	Cr	C0r		Grease lub.	Oil lub.	NU	NJ	NUP	N	NF	da min.	db min.	db max.	dc min.	dd min.	Da max.	Db max.	min.	ra max.	rb max.		
190	400	78	5	5	245	345	1 220	1 260	146	1 300	1 800	<b>NU338</b>	<b>NJ338</b>	<b>NUP338</b>	<b>N338</b>	<b>NF338</b>	210	210	240	248	268	380	380	349	4	4	49.9	
	400	132	5	5	245	—	1 900	2 220	245	1 200	1 800	<b>NU2338</b>	<b>NJ2338</b>	<b>NUP2338</b>	—	—	210	210	240	248	268	380	—	—	4	4	84.7	
	400	155	5	5	245	—	2 340	2 910	316	1 200	1 800	<b>NU3338</b>	—	—	—	—	210	210	240	248	—	380	—	—	4	4	96.5	
200	310	51	2.1	2.1	229	—	487	582	71.0	1 900	2 300	<b>NU1040</b>	—	<b>NUP1040</b>	—	—	211	211	226	233	—	299	—	—	2	2	14.1	
	360	58	4	4	—	316	775	865	102	1 600	1 900	—	—	—	<b>N240</b>	<b>NF240</b>	216	—	—	—	261	344	344	328	3	3	(25.7)	
	360	58	4	4	243	—	958	1 060	124	1 600	1 900	<b>NU240R</b>	<b>NJ240R</b>	<b>NUP240R</b>	—	—	216	216	240	247	261	344	—	—	3	3	27.2	
	360	98	4	4	244	—	1 190	1 490	169	1 400	1 900	<b>NU2240</b>	<b>NJ2240</b>	<b>NUP2240</b>	—	—	216	216	240	247	261	344	—	—	3	3	44.4	
	360	98	4	4	241	—	1 530	1 870	211	1 400	1 900	<b>NU2240R</b>	<b>NJ2240R</b>	<b>NUP2240R</b>	—	—	216	216	240	247	261	344	—	—	3	3	44.4	
	360	128	4	4	244	—	1 500	2 020	223	1 300	1 900	<b>NU3240</b>	—	—	—	—	216	216	240	247	—	344	—	—	3	3	56.2	
	420	80	5	5	260	360	1 220	1 270	145	1 200	1 700	<b>NU340</b>	<b>NJ340</b>	<b>NUP340</b>	<b>N340</b>	<b>NF340</b>	220	220	254	263	283	400	400	364	4	4	56.2	
	420	138	5	5	260	—	1 890	2 240	244	1 100	1 700	<b>NU2340</b>	<b>NJ2340</b>	<b>NUP2340</b>	—	—	220	220	254	263	283	400	—	—	4	4	97.4	
420	165	5	5	260	—	2 330	2 930	314	1 100	1 700	<b>NU3340</b>	—	—	—	—	220	220	250	258	—	400	—	—	4	4	113		
220	340	56	3	3	250	—	637	748	88.1	1 700	2 000	<b>NU1044</b>	—	<b>NUP1044</b>	—	—	233	233	248	254	—	327	—	—	2.5	2.5	18.5	
	400	65	4	4	270	350	949	1 080	123	1 400	1 700	<b>NU244</b>	<b>NJ244</b>	<b>NUP244</b>	<b>N244</b>	<b>NF244</b>	236	236	266	273	289	384	384	362	3	3	38.5	
	400	108	4	4	270	—	1 420	1 810	196	1 200	1 700	<b>NU2244</b>	<b>NJ2244</b>	—	—	—	236	236	266	273	289	384	—	—	3	3	60.9	
	400	144	4	4	270	—	2 040	2 880	319	1 100	1 700	<b>NU3244</b>	—	—	—	—	236	236	266	273	—	384	—	—	3	3	78.8	
	460	88	5	5	284	396	1 490	1 570	176	1 100	1 500	<b>NU344</b>	<b>NJ344</b>	<b>NUP344</b>	<b>N344</b>	<b>NF344</b>	240	240	279	287	309	440	440	400	4	4	74.4	
	460	145	5	5	284	—	2 260	2 690	287	990	1 500	<b>NU2344</b>	—	—	<b>NUP2344</b>	—	—	240	240	276	287	—	440	—	—	4	4	119
	460	180	5	5	284	—	2 660	3 300	347	990	1 500	<b>NU3344</b>	—	—	—	—	240	240	279	287	—	440	—	—	4	4	148	
240	360	56	3	3	270	—	673	822	95.0	1 600	1 900	<b>NU1048</b>	—	<b>NUP1048</b>	—	—	253	253	268	275	—	347	—	—	2.5	2.5	20.1	
	440	72	4	4	295	385	1 170	1 340	150	1 200	1 500	<b>NU248</b>	<b>NJ248</b>	<b>NUP248</b>	<b>N248</b>	<b>NF248</b>	256	256	293	298	316	424	424	397	3	3	52.1	
	440	120	4	4	295	—	1 790	2 320	246	1 100	1 500	<b>NU2248</b>	<b>NJ2248</b>	—	—	—	256	256	293	298	316	424	—	—	3	3	82.5	
	440	160	4	4	295	—	2 450	3 460	358	990	1 500	<b>NU3248</b>	—	—	—	—	256	256	293	298	—	424	—	—	3	3	107	
	500	95	5	5	310	430	1 790	1 950	211	990	1 300	<b>NU348</b>	<b>NJ348</b>	<b>NUP348</b>	<b>N348</b>	<b>NF348</b>	260	260	305	313	337	480	480	434	4	4	94.6	
	500	155	5	5	310	—	2 710	3 320	346	880	1 300	<b>NU2348</b>	—	—	<b>NUP2348</b>	—	—	260	260	303	313	—	480	—	—	4	4	152
	500	195	5	5	310	—	3 170	4 070	414	880	1 300	<b>NU3348</b>	—	—	—	—	260	260	305	313	—	480	—	—	4	4	189	

[Remarks] 1) Standard cage types used for the above bearings are shown in Table 1 earlier in this section. Please note that basic load ratings and limiting speeds shown above indicate the value applicable to machined cage. Consult JTEKT about bearings with pressed cage, since they may be different from bearings with machined cage in values above.

2) Bearing numbers of NU and NJ type bearings with mounted thrust collar (refer to specification table shown after this specification table) are NUJ and NH.

Single-row cylindrical roller bearings

d 260 ~ 460 mm



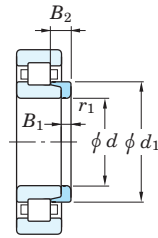
Boundary dimensions (mm)							Basic load ratings (kN)		Fatigue load limit (kN) $C_u$	Limiting speeds (min <sup>-1</sup> )		Bearing No.					Mounting dimensions (mm)								Mass (kg) NU (N)		
d	D	B	r min.	r <sub>1</sub> min.	F <sub>w</sub>	E <sub>w</sub>	C <sub>r</sub>	C <sub>0r</sub>		Grease lub.	Oil lub.	NU	NJ	NUP	N	NF	d <sub>a</sub> min.	d <sub>b</sub> min.	d <sub>b</sub> max.	d <sub>c</sub> min.	d <sub>d</sub> min.	D <sub>a</sub> max.	D <sub>b</sub> max.	r <sub>a</sub> min.		r <sub>b</sub> max.	r <sub>a</sub> max.
260	400	65	4	4	296	—	819	979	110	1 400	1 700	NU1052	—	NUP1052	—	—	276	276	292	300	—	384	—	—	3	3	29.2
	480	80	5	5	320	420	1 380	1 580	171	1 100	1 300	NU252	NJ252	NUP252	N252	NF252	280	280	318	323	343	460	460	432	4	4	69.0
	480	130	5	5	320	—	2 240	2 950	305	990	1 300	NU2252	NJ2252	—	—	—	280	280	318	323	343	460	—	—	4	4	107
	480	174	5	5	320	—	2 680	3 680	373	880	1 300	NU3252	—	—	—	—	280	280	318	323	—	460	—	—	4	4	139
	540	165	6	6	336	—	3 030	3 750	385	790	1 200	NU2352	—	NUP2352	—	—	284	284	327	339	—	516	—	—	5	5	185
	540	206	6	6	336	—	3 670	4 790	473	790	1 200	NU3352	—	—	—	—	284	284	330	339	—	516	—	—	5	5	232
280	420	65	4	4	316	—	841	1 030	114	1 300	1 500	NU1056	—	NUP1056	—	—	296	296	313	320	—	404	—	—	3	3	35.2
	500	80	5	5	340	440	1 430	1 680	179	1 000	1 200	NU256	NJ256	NUP256	N256	NF256	300	300	336	343	365	480	480	452	4	4	72.7
300	460	74	4	4	340	—	1 120	1 380	147	1 200	1 400	NU1060	—	NUP1060	—	—	316	316	337	344	—	444	—	—	3	3	44.1
	540	85	5	5	364	476	1 690	1 960	206	920	1 100	NU260	NJ260	NUP260	N260	NF260	320	320	361	368	392	520	520	487	4	4	90.7
320	480	74	4	4	360	—	1 150	1 450	152	1 100	1 300	NU1064	—	NUP1064	—	—	336	336	356	365	—	464	—	—	3	3	48.4
	580	92	5	5	390	510	1 920	2 270	232	840	1 000	NU264	NJ264	NUP264	N264	NF264	340	340	386	393	419	560	560	522	4	4	114
	670	112	7.5	7.5	425	—	2 460	2 880	287	650	870	NU364	—	—	—	—	352	352	419	428	—	638	638	575	6	6	199
340	520	82	5	5	385	—	1 370	1 750	183	980	1 200	NU1068	—	NUP1068	—	—	360	360	381	390	—	500	—	—	4	4	64.1
360	540	82	5	5	405	—	1 410	1 830	189	920	1 100	NU1072	—	NUP1072	—	—	380	380	401	410	—	520	—	—	4	4	67.1
380	560	82	5	5	425	—	1 440	1 920	195	860	1 000	NU1076	—	NUP1076	—	—	400	400	421	430	—	540	—	—	4	4	70.1
400	600	90	5	5	450	—	1 760	2 310	229	780	920	NU1080	—	NUP1080	—	—	420	420	446	455	—	580	—	—	4	4	91.0
420	620	90	5	5	470	—	1 750	2 320	228	730	860	NU1084	—	NUP1084	—	—	440	440	466	475	—	600	—	—	4	4	94.6
440	650	94	6	6	493	—	1 880	2 520	242	680	800	NU1088	—	NUP1088	—	—	464	464	489	498	—	626	—	—	5	5	109
460	680	100	6	6	516	—	2 000	2 730	259	630	750	NU1092	—	NUP1092	—	—	484	484	512	520	—	656	—	—	5	5	127

[Remarks] 1) Standard cage types used for the above bearings are shown in Table 1 earlier in this section. Please note that basic load ratings and limiting speeds shown above indicate the value applicable to machined cage. Consult JTEKT about bearings with pressed cage, since they may be different from bearings with machined cage in values above.

2) Bearing numbers of NU and NJ type bearings with mounted thrust collar (refer to specification table shown after this specification table) are NUJ and NH.

Thrust collars for cylindrical roller bearings

$d$  20 ~ (35) mm



Thrust collar

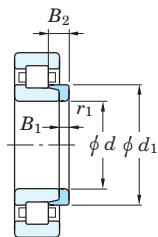
$d$  (35) ~ (50) mm

$d$	Boundary dimensions (mm)				$r_1$ min.	Thrust collar No.	(Refer.) Mass (kg)	Applicable bearing No.	
	$d_1$	$B_1$	$B_2$					NJ	NU
20	29.7	3	6.75	0.6	HJ204	0.012	NJ204	NU204	
	29.8	3	5.5	0.6	HJ204R	0.011	NJ204R	NU204R	
	30	3	7.5	0.6	HJ2204	0.012	NJ2204	NU2204	
	29.8	3	6.5	0.6	HJ2204R	0.012	NJ2204R	NU2204R	
	31.8	4	7.5	0.6	HJ304	0.017	NJ304	NU304	
	31.4	4	6.5	0.6	HJ304R	0.017	NJ304R	NU304R	
	31.8	4	8.5	0.6	HJ2304	0.020	NJ2304	NU2304	
	31.4	4	7.5	0.6	HJ2304R	0.018	NJ2304R	NU2304R	
	25	34.7	3	7.25	0.6	HJ205	0.015	NJ205	NU205
34.8		3	6	0.6	HJ205R	0.014	NJ205R	NU205R	
34.7		3	7.5	0.6	HJ2205	0.015	NJ2205	NU2205	
34.8		3	6.5	0.6	HJ2205R	0.014	NJ2205R	NU2205R	
39		4	8	1.1	HJ305	0.025	NJ305	NU305	
38.2		4	7	1.1	HJ305R	0.025	NJ305R	NU305R	
39		4	9	1.1	HJ2305	0.025	NJ2305	NU2305	
38.2		4	8	1.1	HJ2305R	0.026	NJ2305R	NU2305R	
30		41.8	4	8.25	0.6	HJ206	0.025	NJ206	NU206
	41.4	4	7	0.6	HJ206R	0.025	NJ206R	NU206R	
	41.8	4	8.5	0.6	HJ2206	0.025	NJ2206	NU2206	
	41.4	4	7.5	0.6	HJ2206R	0.025	NJ2206R	NU2206R	
	45.9	5	9.5	1.1	HJ306	0.039	NJ306	NU306	
	45.1	5	8.5	1.1	HJ306R	0.042	NJ306R	NU306R	
	45.9	5	11.5	1.1	HJ2306	0.039	NJ2306	NU2306	
	45.1	5	9.5	1.1	HJ2306R	0.043	NJ2306R	NU2306R	
	50.5	7	11.5	1.5	HJ406	0.080	NJ406	NU406	
	35	47.6	4	8	0.6	HJ207	0.030	NJ207	NU207
		48.2	4	7	0.6	HJ207R	0.033	NJ207R	NU207R
47.6		4	8.5	0.6	HJ2207	0.030	NJ2207	NU2207	

$d$	Boundary dimensions (mm)				$r_1$ min.	Thrust collar No.	(Refer.) Mass (kg)	Applicable bearing No.	
	$d_1$	$B_1$	$B_2$					NJ	NU
35	48.2	4	8.5	0.6	HJ2207R	0.035	NJ2207R	NU2207R	
	50.8	6	11	1.1	HJ307	0.056	NJ307	NU307	
	51.1	6	9.5	1.1	HJ307R	0.060	NJ307R	NU307R	
	50.8	6	14	1.1	HJ2307	0.056	NJ2307	NU2307	
	51.1	6	11	1.1	HJ2307R	0.062	NJ2307R	NU2307R	
	59	8	13	1.5	HJ407	0.120	NJ407	NU407	
	40	54.2	5	9	1.1	HJ208	0.046	NJ208	NU208
54.1		5	8.5	1.1	HJ208R	0.049	NJ208R	NU208R	
54.2		5	9.5	1.1	HJ2208	0.046	NJ2208	NU2208	
54.1		5	9	1.1	HJ2208R	0.050	NJ2208R	NU2208R	
58.4		7	12.5	1.5	HJ308	0.083	NJ308	NU308	
57.7		7	11	1.5	HJ308R	0.088	NJ308R	NU308R	
58.4		7	14.5	1.5	HJ2308	0.083	NJ2308	NU2308	
57.7		7	12.5	1.5	HJ2308R	0.091	NJ2308R	NU2308R	
64.8		8	13	2	HJ408	0.140	NJ408	NU408	
45		59	5	9.5	1.1	HJ209	0.053	NJ209	NU209
	59.1	5	8.5	1.1	HJ209R	0.055	NJ209R	NU209R	
	59	5	9.5	1.1	HJ2209	0.053	NJ2209	NU2209	
	59.1	5	9	1.1	HJ2209R	0.055	NJ2209R	NU2209R	
	64	7	12.5	1.5	HJ309	0.099	NJ309	NU309	
	64.5	7	11.5	1.5	HJ309R	0.110	NJ309R	NU309R	
	64	7	15	1.5	HJ2309	0.099	NJ2309	NU2309	
	64.5	7	13	1.5	HJ2309R	0.113	NJ2309R	NU2309R	
	71.8	8	13.5	2	HJ409	0.175	NJ409	NU409	
	50	64.6	5	10	1.1	HJ210	0.063	NJ210	NU210
		64.1	5	9	1.1	HJ210R	0.061	NJ210R	NU210R
64.6		5	9.5	1.1	HJ2210	0.063	NJ2210	NU2210	
64.1		5	9	1.1	HJ2210R	0.061	NJ2210R	NU2210R	
71		8	14	2	HJ310	0.142	NJ310	NU310	

Thrust collars for cylindrical roller bearings

$d$  (50) ~ (65) mm



Thrust collar

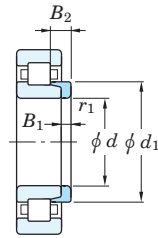
Boundary dimensions (mm)					Thrust collar No.	(Refer.) Mass (kg)	Applicable bearing No.	
$d$	$d_1$	$B_1$	$B_2$	$r_1$ min.			NJ	NU
<b>50</b>	71.4	8	13	2	<b>HJ310R</b>	0.151	NJ310R	NU310R
	71	8	17	2	<b>HJ2310</b>	0.142	NJ2310	NU2310
	71.4	8	14.5	2	<b>HJ2310R</b>	0.155	NJ2310R	NU2310R
	78.8	9	14.5	2.1	<b>HJ410</b>	0.230	NJ410	NU410
<b>55</b>	70.8	6	11	1.1	<b>HJ211</b>	0.084	NJ211	NU211
	70.9	6	9.5	1.1	<b>HJ211R</b>	0.087	NJ211R	NU211R
	70.8	6	11	1.1	<b>HJ2211</b>	0.084	NJ2211	NU2211
	70.9	6	10	1.1	<b>HJ2211R</b>	0.088	NJ2211R	NU2211R
	77.2	9	15	2	<b>HJ311</b>	0.182	NJ311	NU311
	77.6	9	14	2	<b>HJ311R</b>	0.195	NJ311R	NU311R
	77.2	9	18.5	2	<b>HJ2311</b>	0.182	NJ2311	NU2311
	77.6	9	15.5	2	<b>HJ2311R</b>	0.200	NJ2311R	NU2311R
	85.2	10	16.5	2.1	<b>HJ411</b>	0.290	NJ411	NU411
	<b>60</b>	78.4	6	11	1.5	<b>HJ212</b>	0.108	NJ212
77.7		6	10	1.5	<b>HJ212R</b>	0.108	NJ212R	NU212R
78.4		6	11	1.5	<b>HJ2212</b>	0.108	NJ2212	NU2212
77.7		6	10	1.5	<b>HJ2212R</b>	0.108	NJ2212R	NU2212R
84.2		9	15.5	2.1	<b>HJ312</b>	0.220	NJ312	NU312
84.5		9	14.5	2.1	<b>HJ312R</b>	0.231	NJ312R	NU312R
84.2		9	19	2.1	<b>HJ2312</b>	0.220	NJ2312	NU2312
84.5		9	16	2.1	<b>HJ2312R</b>	0.237	NJ2312R	NU2312R
91.8		10	16.5	2.1	<b>HJ412</b>	0.340	NJ412	NU412
<b>65</b>		84.8	6	11	1.5	<b>HJ213</b>	0.123	NJ213
	84.5	6	10	1.5	<b>HJ213R</b>	0.129	NJ213R	NU213R
	84.8	6	11.5	1.5	<b>HJ2213</b>	0.123	NJ2213	NU2213
	84.5	6	10.5	1.5	<b>HJ2213R</b>	0.131	NJ2213R	NU2213R
	91	10	17	2.1	<b>HJ313</b>	0.280	NJ313	NU313
	90.6	10	15.5	2.1	<b>HJ313R</b>	0.288	NJ313R	NU313R

$d$  (65) ~ (80) mm

Boundary dimensions (mm)					Thrust collar No.	(Refer.) Mass (kg)	Applicable bearing No.	
$d$	$d_1$	$B_1$	$B_2$	$r_1$ min.			NJ	NU
<b>65</b>	91	10	20	2.1	<b>HJ2313</b>	0.280	NJ2313	NU2313
	90.6	10	18	2.1	<b>HJ2313R</b>	0.298	NJ2313R	NU2313R
	98.5	11	18	2.1	<b>HJ413</b>	0.420	NJ413	NU413
<b>70</b>	89.6	7	12.5	1.5	<b>HJ214</b>	0.150	NJ214	NU214
	89.5	7	11	1.5	<b>HJ214R</b>	0.157	NJ214R	NU214R
	89.6	7	12.5	1.5	<b>HJ2214</b>	0.150	NJ2214	NU2214
	89.5	7	11.5	1.5	<b>HJ2214R</b>	0.158	NJ2214R	NU2214R
	98	10	17.5	2.1	<b>HJ314</b>	0.330	NJ314	NU314
	97.5	10	15.5	2.1	<b>HJ314R</b>	0.330	NJ314R	NU314R
	98	10	20.5	2.1	<b>HJ2314</b>	0.330	NJ2314	NU2314
	97.5	10	18.5	2.1	<b>HJ2314R</b>	0.345	NJ2314R	NU2314R
	110.5	12	20	3	<b>HJ414</b>	0.605	NJ414	NU414
	<b>75</b>	94	7	12.5	1.5	<b>HJ215</b>	0.156	NJ215
94.5		7	11	1.5	<b>HJ215R</b>	0.166	NJ215R	NU215R
94		7	12.5	1.5	<b>HJ2215</b>	0.156	NJ2215	NU2215
94.5		7	11.5	1.5	<b>HJ2215R</b>	0.167	NJ2215R	NU2215R
104.2		11	18.5	2.1	<b>HJ315</b>	0.400	NJ315	NU315
104.2		11	16.5	2.1	<b>HJ315R</b>	0.410	NJ315R	NU315R
104.2		11	21.5	2.1	<b>HJ2315</b>	0.400	NJ2315	NU2315
104.2		11	19.5	2.1	<b>HJ2315R</b>	0.430	NJ2315R	NU2315R
116		13	21.5	3	<b>HJ415</b>	0.710	NJ415	NU415
<b>80</b>		101.2	8	13.5	2	<b>HJ216</b>	0.207	NJ216
	101.6	8	12.5	2	<b>HJ216R</b>	0.222	NJ216R	NU216R
	101.2	8	13.5	2	<b>HJ2216</b>	0.207	NJ2216	NU2216
	101.6	8	12.5	2	<b>HJ2216R</b>	0.222	NJ2216R	NU2216R
	111.8	11	19.5	2.1	<b>HJ316</b>	0.470	NJ316	NU316
	110.6	11	17	2.1	<b>HJ316R</b>	0.460	NJ316R	NU316R
	111.8	11	23	2.1	<b>HJ2316</b>	0.470	NJ2316	NU2316
	110.6	11	20	2.1	<b>HJ2316R</b>	0.480	NJ2316R	NU2316R

Thrust collars for cylindrical roller bearings

$d$  (80) ~ (100) mm



Thrust collar

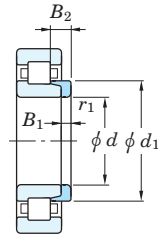
$d$  (100) ~ 120 mm

Boundary dimensions (mm)					Thrust collar No.	(Refer.) Mass (kg)	Applicable bearing No.	
$d$	$d_1$	$B_1$	$B_2$	$r_1$ min.			NJ	NU
<b>80</b>	122	13	22	3	<b>HJ416</b>	0.780	NJ416	NU416
<b>85</b>	108.2	8	14	2	<b>HJ217</b>	0.250	NJ217	NU217
	107.6	8	12.5	2	<b>HJ217R</b>	0.250	NJ217R	NU217R
	108.2	8	14	2	<b>HJ2217</b>	0.250	NJ2217	NU2217
	107.6	8	13	2	<b>HJ2217R</b>	0.252	NJ2217R	NU2217R
	117.5	12	20.5	3	<b>HJ317</b>	0.560	NJ317	NU317
	117.9	12	18.5	3	<b>HJ317R</b>	0.575	NJ317R	NU317R
	117.5	12	24	3	<b>HJ2317</b>	0.560	NJ2317	NU2317
	117.9	12	22	3	<b>HJ2317R</b>	0.595	NJ2317R	NU2317R
126	14	24	4	<b>HJ417</b>	0.880	NJ417	NU417	
<b>90</b>	114.2	9	15	2	<b>HJ218</b>	0.305	NJ218	NU218
	114.4	9	14	2	<b>HJ218R</b>	0.320	NJ218R	NU218R
	114.2	9	16	2	<b>HJ2218</b>	0.305	NJ2218	NU2218
	114.4	9	15	2	<b>HJ2218R</b>	0.325	NJ2218R	NU2218R
	125	12	21	3	<b>HJ318</b>	0.630	NJ318	NU318
	124.2	12	18.5	3	<b>HJ318R</b>	0.630	NJ318R	NU318R
	125	12	26	3	<b>HJ2318</b>	0.630	NJ2318	NU2318
	124.2	12	22	3	<b>HJ2318R</b>	0.660	NJ2318R	NU2318R
137	14	24	4	<b>HJ418</b>	1.05	NJ418	NU418	
<b>95</b>	121	9	15.5	2.1	<b>HJ219</b>	0.352	NJ219	NU219
	120.6	9	14	2.1	<b>HJ219R</b>	0.355	NJ219R	NU219R
	121	9	16.5	2.1	<b>HJ2219</b>	0.352	NJ2219	NU2219
	120.6	9	15.5	2.1	<b>HJ2219R</b>	0.365	NJ2219R	NU2219R
	132	13	22.5	3	<b>HJ319</b>	0.760	NJ319	NU319
	132.2	13	20.5	3	<b>HJ319R</b>	0.785	NJ319R	NU319R
	132	13	26.5	3	<b>HJ2319</b>	0.760	NJ2319	NU2319
	147	15	25.5	4	<b>HJ419</b>	1.30	NJ419	NU419
<b>100</b>	128	10	17	2.1	<b>HJ220</b>	0.444	NJ220	NU220

Boundary dimensions (mm)					Thrust collar No.	(Refer.) Mass (kg)	Applicable bearing No.	
$d$	$d_1$	$B_1$	$B_2$	$r_1$ min.			NJ	NU
<b>100</b>	127.5	10	15	2.1	<b>HJ220R</b>	0.435	NJ220R	NU220R
	128	10	18	2.1	<b>HJ2220</b>	0.444	NJ2220	NU2220
	127.5	10	16	2.1	<b>HJ2220R</b>	0.450	NJ2220R	NU2220R
	140.5	13	22.5	3	<b>HJ320</b>	0.895	NJ320	NU320
	139.6	13	20.5	3	<b>HJ320R</b>	0.890	NJ320R	NU320R
	140.5	13	27.5	3	<b>HJ2320</b>	0.895	NJ2320	NU2320
	139.6	13	23.5	3	<b>HJ2320R</b>	0.920	NJ2320R	NU2320R
	153.5	16	27	4	<b>HJ420</b>	1.50	NJ420	NU420
<b>105</b>	135	10	17.5	2.1	<b>HJ221</b>	0.505	NJ221	NU221
	147	13	22.5	3	<b>HJ321</b>	0.970	NJ321	NU321
	159.5	16	27	4	<b>HJ421</b>	1.65	NJ421	NU421
<b>110</b>	141.5	11	18.5	2.1	<b>HJ222</b>	0.615	NJ222	NU222
	141.7	11	17	2.1	<b>HJ222R</b>	0.620	NJ222R	NU222R
	141.5	11	20.5	2.1	<b>HJ2222</b>	0.615	NJ2222	NU2222
	141.7	11	19.5	2.1	<b>HJ2222R</b>	0.645	NJ2222R	NU2222R
	155.5	14	23	3	<b>HJ322</b>	1.17	NJ322	NU322
	155.8	14	22	3	<b>HJ322R</b>	1.21	NJ322R	NU322R
	155.5	14	28	3	<b>HJ2322</b>	1.17	NJ2322	NU2322
	155.8	14	26.5	3	<b>HJ2322R</b>	1.27	NJ2322R	NU2322R
171	17	29.5	4	<b>HJ422</b>	2.10	NJ422	NU422	
<b>120</b>	153	11	19	2.1	<b>HJ224</b>	0.715	NJ224	NU224
	153.4	11	17	2.1	<b>HJ224R</b>	0.710	NJ224R	NU224R
	153	11	22	2.1	<b>HJ2224</b>	0.715	NJ2224	NU2224
	153.4	11	20	2.1	<b>HJ2224R</b>	0.745	NJ2224R	NU2224R
	168.5	14	23.5	3	<b>HJ324</b>	1.40	NJ324	NU324
	168.6	14	22.5	3	<b>HJ324R</b>	1.41	NJ324R	NU324R
	168.5	14	28	3	<b>HJ2324</b>	1.40	NJ2324	NU2324
	168.6	14	26	3	<b>HJ2324R</b>	1.46	NJ2324R	NU2324R
188	17	30.5	5	<b>HJ424</b>	2.60	NJ424	NU424	

Thrust collars for cylindrical roller bearings

$d$  130 ~ (160) mm



Thrust collar

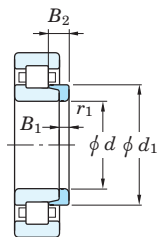
$d$  (160) ~ (200) mm

Boundary dimensions (mm)					Thrust collar No.	(Refer.) Mass (kg)	Applicable bearing No.	
$d$	$d_1$	$B_1$	$B_2$	$r_1$ min.			NJ	NU
<b>130</b>	165.5	11	19	3	<b>HJ226</b>	0.840	NJ226	NU226
	164.2	11	17	3	<b>HJ226R</b>	0.790	NJ226R	NU226R
	165.5	11	25	3	<b>HJ2226</b>	0.840	NJ2226	NU2226
	164.2	11	21	3	<b>HJ2226R</b>	0.840	NJ2226R	NU2226R
	182	14	24	4	<b>HJ326</b>	1.62	NJ326	NU326
	182.3	14	23	4	<b>HJ326R</b>	1.65	NJ326R	NU326R
	182	14	29.5	4	<b>HJ2326</b>	1.62	NJ2326	NU2326
	182.3	14	28	4	<b>HJ2326R</b>	1.73	NJ2326R	NU2326R
	205	18	32	5	<b>HJ426</b>	3.30	NJ426	NU426
	<b>140</b>	179.5	11	19	3	<b>HJ228</b>	1.00	NJ228
180		11	18	3	<b>HJ228R</b>	0.990	NJ228R	NU228R
179.5		11	25	3	<b>HJ2228</b>	1.00	NJ2228	NU2228
180		11	23	3	<b>HJ2228R</b>	1.07	NJ2228R	NU2228R
196		15	26	4	<b>HJ328</b>	1.93	NJ328	NU328
196		15	25	4	<b>HJ328R</b>	2.04	NJ328R	NU328R
196		15	33.5	4	<b>HJ2328</b>	1.98	NJ2328	NU2328
196		15	31	4	<b>HJ2328R</b>	2.14	NJ2328R	NU2328R
219		18	33	5	<b>HJ428</b>	3.75	NJ428	NU428
<b>150</b>		193	12	20.5	3	<b>HJ230</b>	1.24	NJ230
	193.7	12	19.5	3	<b>HJ230R</b>	1.26	NJ230R	NU230R
	193	12	26.5	3	<b>HJ2230</b>	1.24	NJ2230	NU2230
	193.7	12	24.5	3	<b>HJ2230R</b>	1.35	NJ2230R	NU2230R
	210	15	26.5	4	<b>HJ330</b>	2.37	NJ330	NU330
	210	15	25	4	<b>HJ330R</b>	2.35	NJ330R	NU330R
	210	15	34	4	<b>HJ2330</b>	2.37	NJ2330	NU2330
	210	15	31.5	4	<b>HJ2330R</b>	2.48	NJ2330R	NU2330R
	234	20	36.5	5	<b>HJ430</b>	4.70	NJ430	NU430
	<b>160</b>	207	12	21	3	<b>HJ232</b>	1.48	NJ232
207.3		12	20	3	<b>HJ232R</b>	1.48	NJ232R	NU232R

Boundary dimensions (mm)					Thrust collar No.	(Refer.) Mass (kg)	Applicable bearing No.	
$d$	$d_1$	$B_1$	$B_2$	$r_1$ min.			NJ	NU
<b>160</b>	205	12	28	3	<b>HJ2232</b>	1.48	NJ2232	NU2232
	206.1	12	24.5	3	<b>HJ2232R</b>	1.55	NJ2232R	NU2232R
	225	15	28	4	<b>HJ332</b>	2.75	NJ332	NU332
	222.1	15	25	4	<b>HJ332R</b>	2.59	NJ332R	NU332R
	225	15	37	4	<b>HJ2332</b>	2.75	NJ2332	NU2332
	222.1	15	32	4	<b>HJ2332R</b>	2.76	NJ2332R	NU2332R
<b>170</b>	220.5	12	22	4	<b>HJ234</b>	1.70	NJ234	NU234
	220.8	12	20	4	<b>HJ234R</b>	1.70	NJ234R	NU234R
	219	12	29	4	<b>HJ2234</b>	1.70	NJ2234	NU2234
	219.5	12	24	4	<b>HJ2234R</b>	1.79	NJ2234R	NU2234R
	238	16	29.5	4	<b>HJ334</b>	3.25	NJ334	NU334
	238	16	38.5	4	<b>HJ2334</b>	3.25	NJ2334	NU2334
<b>180</b>	230.5	12	22	4	<b>HJ236</b>	1.80	NJ236	NU236
	230.8	12	20	4	<b>HJ236R</b>	1.79	NJ236R	NU236R
	229	12	29	4	<b>HJ2236</b>	1.80	NJ2236	NU2236
	229.5	12	24	4	<b>HJ2236R</b>	1.88	NJ2236R	NU2236R
	252	17	30.5	4	<b>HJ336</b>	3.85	NJ336	NU336
	252	17	40	4	<b>HJ2336</b>	3.85	NJ2336	NU2336
<b>190</b>	244.5	13	23.5	4	<b>HJ238</b>	2.20	NJ238	NU238
	244.5	13	21.5	4	<b>HJ238R</b>	2.19	NJ238R	NU238R
	243	13	31.5	4	<b>HJ2238</b>	2.20	NJ2238	NU2238
	243.2	13	26.5	4	<b>HJ2238R</b>	2.31	NJ2238R	NU2238R
	265	18	32	5	<b>HJ338</b>	4.45	NJ338	NU338
	265	18	41.5	5	<b>HJ2338</b>	4.45	NJ2338	NU2338
<b>200</b>	258	14	25	4	<b>HJ240</b>	2.60	NJ240	NU240
	258.2	14	23	4	<b>HJ240R</b>	2.65	NJ240R	NU240R
	258	14	34	4	<b>HJ2240</b>	2.60	NJ2240	NU2240
	256.9	14	28	4	<b>HJ2240R</b>	2.78	NJ2240R	NU2240R
	280	18	33	5	<b>HJ340</b>	5.00	NJ340	NU340

Thrust collars for cylindrical roller bearings

$d$  (200) ~ 320 mm



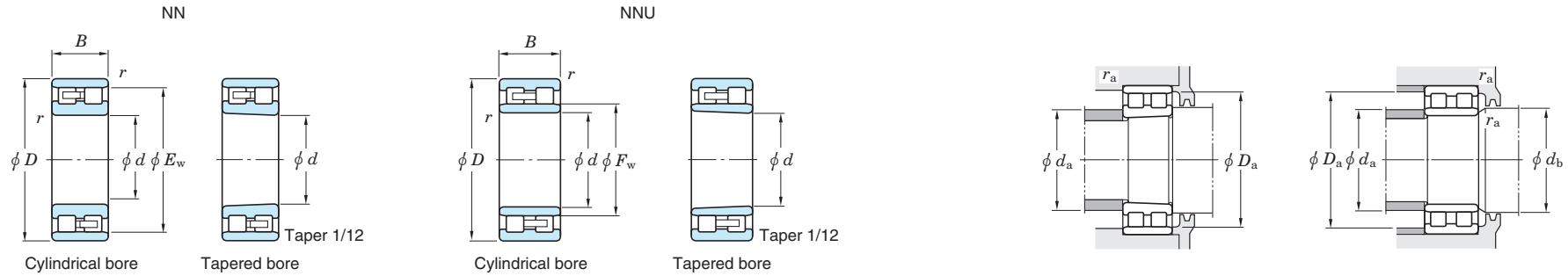
Thrust collar

Boundary dimensions (mm)					Thrust collar No.	(Refer.) Mass (kg)	Applicable bearing No.	
$d$	$d_1$	$B_1$	$B_2$	$r_1$ min.			NJ	NU
200	280	18	44.5	5	HJ2340	5.00	NJ2340	NU2340
220	286	15	27.5	4	HJ244	3.55	NJ244	NU244
	286	15	36.5	4	HJ2244	3.55	NJ2244	NU2244
	307	20	36	5	HJ344	7.05	NJ344	NU344
240	313	16	29.5	4	HJ248	4.65	NJ248	NU248
	313	16	38.5	4	HJ2248	4.65	NJ2248	NU2248
	335	22	39.5	5	HJ348	8.20	NJ348	NU348
260	340	18	33	5	HJ252	6.20	NJ252	NU252
	340	18	40.5	5	HJ2252	6.20	NJ2252	NU2252
280	360	18	33	5	HJ256	7.15	NJ256	NU256
300	387	20	34.5	5	HJ260	7.40	NJ260	NU260
320	415	21	37	5	HJ264	11.3	NJ264	NU264



Double-row cylindrical roller bearings

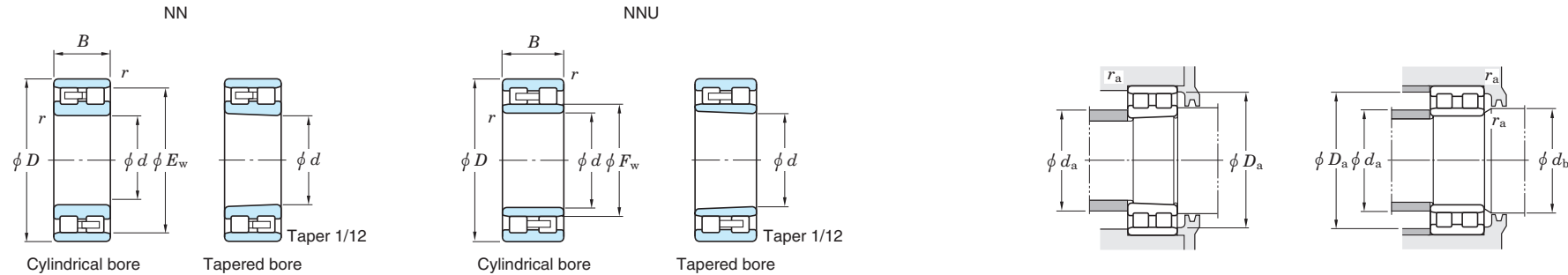
d 25 ~ (110) mm



Boundary dimensions (mm)							Basic load ratings (kN)		Fatigue load limit (kN) C <sub>u</sub>	Limiting speeds (min <sup>-1</sup> )		Bearing No.		Mounting dimensions (mm)							(Refer.) Mass (kg)		
d	D	B	r <sub>min.</sub>	F <sub>w</sub>	E <sub>w</sub>	C <sub>r</sub>	C <sub>0r</sub>	Grease lub.		Oil lub.	Cylindrical bore	Tapered bore	Cylindrical bore	Tapered bore	d <sub>a</sub> min.	d <sub>a</sub> max.	d <sub>b</sub> min.	d <sub>b</sub> max.	D <sub>a</sub> min.	D <sub>a</sub> max.	r <sub>a</sub> min.	r <sub>a</sub> max.	Cylindrical bore
25	47	16	0.6	—	41.3	32.2	30.0	5.20	14 000	17 000	NN3005	NN3005K	—	—	29	—	—	43	42	0.6	—	0.127	0.123
30	55	19	1	—	48.5	46.0	44.1	4.95	12 000	14 000	NN3006	NN3006K	—	—	35	—	—	50	49	1	—	0.198	0.192
35	62	20	1	—	55	49.1	50.0	5.65	10 000	12 000	NN3007	NN3007K	—	—	40	—	—	57	56	1	—	0.253	0.246
40	68	21	1	—	61	52.0	55.9	6.35	9 100	11 000	NN3008	NN3008K	—	—	45	—	—	63	62	1	—	0.307	0.298
45	75	23	1	—	67.5	67.1	71.9	8.75	8 300	9 900	NN3009	NN3009K	—	—	50	—	—	70	69	1	—	0.404	0.382
50	80	23	1	—	72.5	66.4	72.6	8.85	7 600	9 100	NN3010	NN3010K	—	—	55	—	—	75	74	1	—	0.429	0.415
55	90	26	1.1	—	81	89.6	101	13.2	6 800	8 200	NN3011	NN3011K	—	—	61.5	—	—	83.5	82	1	—	0.637	0.618
60	95	26	1.1	—	86.1	91.6	106	13.9	6 400	7 700	NN3012	NN3012K	—	—	66.5	—	—	88.5	87	1	—	0.685	0.664
65	100	26	1.1	—	91	93.6	111	14.6	6 000	7 200	NN3013	NN3013K	—	—	71.5	—	—	93.5	92	1	—	0.728	0.705
70	110	30	1.1	—	100	122	148	20.6	5 500	6 500	NN3014	NN3014K	—	—	76.5	—	—	103.5	101	1	—	1.04	1.02
75	115	30	1.1	—	105	124	155	21.5	5 200	6 200	NN3015	NN3015K	—	—	81.5	—	—	108.5	106	1	—	1.11	1.08
80	125	34	1.1	—	113	149	186	26.6	4 800	5 800	NN3016	NN3016K	—	—	86.5	—	—	118.5	114	1	—	1.55	1.50
85	130	34	1.1	—	118	152	194	27.3	4 600	5 500	NN3017	NN3017K	—	—	91.5	—	—	123.5	119	1	—	1.63	1.58
90	140	37	1.5	—	127	179	228	29.3	4 200	5 100	NN3018	NN3018K	—	—	98	—	—	132	129	1.5	—	2.07	2.01
95	145	37	1.5	—	132	188	246	31.3	4 100	4 900	NN3019	NN3019K	—	—	103	—	—	137	134	1.5	—	2.17	2.10
100	140	40	1.1	113	—	173	258	32.9	4 000	4 800	—	—	NNU4920	NNU4920K	106.5	111	115	133.5	—	1	—	1.95	1.87
	150	37	1.5	—	137	196	265	33.3	3 900	4 700	NN3020	NN3020K	—	—	108	—	—	142	139	1.5	—	2.28	2.21
105	145	40	1.1	118	—	196	306	40.2	3 900	4 600	—	—	NNU4921	NNU4921K	111.5	116	120	138.5	—	1	—	2.00	1.91
	160	41	2	—	146	247	322	42.5	3 700	4 400	NN3021	NN3021K	—	—	114	—	—	151	148	2	—	2.88	2.81
110	150	40	1.1	123	—	204	326	42.4	3 700	4 500	—	—	NNU4922	NNU4922K	116.5	121	125	143.5	—	1	—	2.10	2.01

# Double-row cylindrical roller bearings

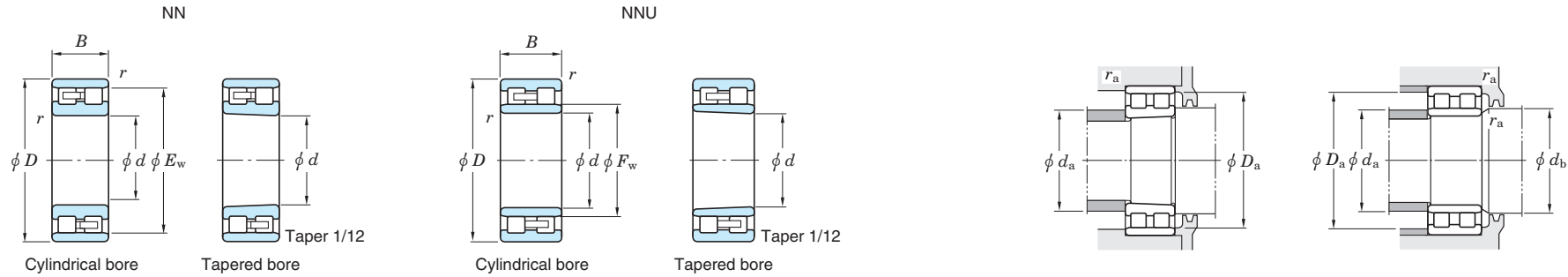
$d$  (110) ~ (260) mm



Boundary dimensions (mm)						Basic load ratings (kN)		Fatigue load limit (kN)	Limiting speeds (min <sup>-1</sup> )		Bearing No. NN		NNU		Mounting dimensions (mm)						(Refer.) Mass (kg)			
$d$	$D$	$B$	$r$ min.	$F_w$	$E_w$	$C_r$	$C_{Or}$	$C_u$	Grease lub.	Oil lub.	Cylindrical bore	Tapered bore	Cylindrical bore	Tapered bore	$d_a$ min.	$d_a$ max.	$d_b$ min.	$d_b$ max.	$D_a$ min.	$D_a$ max.	$r_a$ min.	$r_a$ max.	Cylindrical bore	Tapered bore
110	170	45	2	—	155	278	361	47.9	3 500	4 200	<b>NN3022</b>	<b>NN3022K</b>	—	—	119	—	—	161	157	2	—	—	3.65	3.56
120	165	45	1.1	134.5	—	234	373	47.6	3 400	4 000	—	—	<b>NNU4924</b>	<b>NNU4924K</b>	126.5	132	137	158.5	—	1	—	—	2.90	2.77
	180	46	2	—	165	291	392	51.1	3 200	3 900	<b>NN3024</b>	<b>NN3024K</b>	—	—	129	—	—	171	167	2	—	—	4.00	3.87
130	180	50	1.5	146	—	269	428	50.2	3 100	3 700	—	—	<b>NNU4926</b>	<b>NNU4926K</b>	138	143.5	148	172	—	1.5	—	—	3.90	3.73
	200	52	2	—	182	356	476	57.7	2 900	3 500	<b>NN3026</b>	<b>NN3026K</b>	—	—	139	—	—	191	183	2	—	—	5.94	5.76
140	190	50	1.5	156	—	277	456	52.5	2 900	3 500	—	—	<b>NNU4928</b>	<b>NNU4928K</b>	148	153.5	158	182	—	1.5	—	—	4.15	3.97
	210	53	2	—	192	372	516	61.5	2 700	3 300	<b>NN3028</b>	<b>NN3028K</b>	—	—	149	—	—	201	194	2	—	—	6.41	6.21
150	210	60	2	168.5	—	430	692	80.7	2 600	3 100	—	—	<b>NNU4930</b>	<b>NNU4930K</b>	159	166	171	201	—	2	—	—	6.50	6.22
	225	56	2.1	—	206	418	587	70.1	2 500	3 000	<b>NN3030</b>	<b>NN3030K</b>	—	—	161	—	—	214	208	2	—	—	7.74	7.50
160	220	60	2	178.5	—	425	695	79.8	2 500	3 000	—	—	<b>NNU4932</b>	<b>NNU4932K</b>	169	176	182	211	—	2	—	—	6.95	6.65
	240	60	2.1	—	219	499	695	79.6	2 400	2 800	<b>NN3032</b>	<b>NN3032K</b>	—	—	171	—	—	229	221	2	—	—	9.38	9.08
170	230	60	2	188.5	—	451	763	86.4	2 300	2 800	—	—	<b>NNU4934</b>	<b>NNU4934K</b>	179	186	192	221	—	2	—	—	7.20	6.88
	260	67	2.1	—	236	592	824	105	2 200	2 600	<b>NN3034</b>	<b>NN3034K</b>	—	—	181	—	—	249	238	2	—	—	12.8	12.4
180	250	69	2	202	—	572	964	117	2 100	2 600	—	—	<b>NNU4936</b>	<b>NNU4936K</b>	189	199.5	205	241	—	2	—	—	10.5	10.1
	280	74	2.1	—	255	705	958	118	2 000	2 400	<b>NN3036</b>	<b>NN3036K</b>	—	—	191	—	—	269	257	2	—	—	16.8	16.3
190	260	69	2	210	—	581	996	119	2 000	2 400	—	—	<b>NNU4938</b>	<b>NNU4938K</b>	199	207	215	251	—	2	—	—	11.0	10.5
	290	75	2.1	—	265	752	1 020	128	1 900	2 300	<b>NN3038</b>	<b>NN3038K</b>	—	—	201	—	—	279	267	2	—	—	17.6	17.1
200	280	80	2.1	223	—	636	1 050	125	1 900	2 300	—	—	<b>NNU4940</b>	<b>NNU4940K</b>	211	219.5	228	269	—	2	—	—	15.4	14.7
	310	82	2.1	—	282	793	1 120	137	1 700	2 100	<b>NN3040</b>	<b>NN3040K</b>	—	—	211	—	—	299	285	2	—	—	22.5	21.8
220	300	80	2.1	244	—	701	1 220	145	1 700	2 000	—	—	<b>NNU4944</b>	<b>NNU4944K</b>	231	241	248	289	—	2	—	—	16.7	16.0
	340	90	3	—	310	944	1 370	163	1 600	1 900	<b>NN3044</b>	<b>NN3044K</b>	—	—	233	—	—	327	313	2.5	—	—	29.3	28.4
240	320	80	2.1	263	—	736	1 340	155	1 600	1 900	—	—	<b>NNU4948</b>	<b>NNU4948K</b>	251	260	269	309	—	2	—	—	18.0	17.2
	360	92	3	—	330	1 090	1 590	184	1 400	1 700	<b>NN3048</b>	<b>NN3048K</b>	—	—	253	—	—	347	333	2.5	—	—	32.8	31.8
260	360	100	2.1	287	—	1 180	2 050	228	1 400	1 700	—	—	<b>NNU4952</b>	<b>NNU4952K</b>	271	284	296	349	—	2	—	—	31.4	30.0

# Double-row cylindrical roller bearings

$d$  (260) ~ 460 mm



Boundary dimensions (mm)						Basic load ratings (kN)		Fatigue load limit (kN) $C_u$	Limiting speeds ( $\text{min}^{-1}$ )		Bearing No.		Mounting dimensions (mm)						(Refer.) Mass (kg)				
$d$	$D$	$B$	$r_{\text{min}}$	$F_w$	$E_w$	$C_r$	$C_{0r}$		Grease lub.	Oil lub.	Cylindrical bore	Tapered bore	Cylindrical bore	Tapered bore	$d_a$ min.	$d_a$ max.	$d_b$ min.	$d_b$ max.	$D_a$ min.	$D_a$ max.	$r_a$ min.	$r_a$ max.	Cylindrical bore
260	400	104	4	—	364	1 290	1 830	204	1 300	1 500	NN3052	NN3052K	—	—	276	—	—	384	367	3	—	47.4	46.0
	420	106	4	—	384	1 370	2 010	220	1 200	1 400	—	—	NNU4956	NNU4956K	291	305	316	369	—	2	—	33.1	31.6
280	380	100	2.1	308	—	1 220	2 200	239	1 300	1 500	—	—	—	—	296	—	—	404	387	3	—	51.2	49.6
	420	118	3	339	—	1 470	2 720	285	1 100	1 300	—	—	NNU4960	NNU4960K	313	335	343	407	—	2.5	—	51.9	49.7
300	460	118	4	—	418	1 610	2 460	266	1 100	1 300	NN3060	NN3060K	—	—	316	—	—	444	421	3	—	70.8	68.7
	440	118	3	352	—	1 530	2 750	286	1 100	1 300	—	—	NNU4964	NNU4964K	333	348	363	427	—	2.5	—	53.7	51.4
320	480	121	4	—	438	1 690	2 670	283	980	1 200	NN3064	NN3064K	—	—	336	—	—	464	442	3	—	76.4	74.0
	460	133	5	—	473	2 090	3 090	345	880	1 100	—	—	NNU4968	NNU4968K	353	368	383	447	—	2.5	—	56.8	54.3
340	520	133	5	—	473	2 090	3 090	345	880	1 100	NN3068	NN3068K	—	—	360	—	—	500	477	4	—	101	97.8
	540	134	5	—	493	1 950	3 090	315	830	990	NN3072	NN3072K	—	—	380	—	—	520	497	4	—	107	104
380	560	135	5	—	510	2 050	3 350	337	780	940	NN3076	NN3076K	—	—	400	—	—	540	514	4	—	113	109
400	600	148	5	—	548	2 550	4 140	414	700	850	NN3080	NN3080K	—	—	420	—	—	580	552	4	—	146	141
420	620	150	5	—	570	2 900	4 570	449	670	800	NN3084	NN3084K	—	—	440	—	—	600	574	4	—	154	149
440	650	157	6	—	597	3 160	5 060	489	620	740	NN3088	NN3088K	—	—	464	—	—	626	602	5	—	177	171
460	680	163	6	—	627	3 390	5 480	521	570	690	NN3092	NN3092K	—	—	484	—	—	656	632	5	—	201	195

## Tapered roller bearings

Tapered roller bearings are designed such that outer ring, inner ring and rollers have tapered surfaces whose apexes converge at a common point on the bearing axis. Along with metric series bearings, inch series bearings are also available.

This type of bearing is suitable for applications that involve heavy or impact loading.

### ■ Single-row tapered roller bearings

- Able to carry radial and axial load in one direction simultaneously.

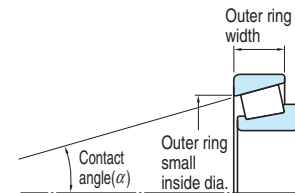
Because an axial component of force is produced when this type of bearing is loaded radially, two bearings are used together facing one another, or two or more bearings are matched and used.

- There are the standard, medium and steep type which are different in contact angle size.

Medium-tapered metric series bearings are identified by the supplementary code "C" which is added as a suffix to bearing numbers.

- Bearings whose outer ring width, outer ring small inside diameter and contact angle are determined in accordance with ISO 355 specifications are identified by the supplementary code "J" as a suffix.

Inner ring assemblies and the outer rings of such bearings are interchangeable with those of bearings produced abroad if the bearing numbers are the same.



ISO sub-unit specifications

### ■ Double-row tapered roller bearings

- These bearings are divided into the TDO type which has one double outer ring and two single-row inner rings, and the TDI type which has two single-row outer rings and one double inner ring. Both accommodate radial and axial loading in both directions.

These two also carry moment loads, however, the TDO type is superior to the TDI type, because the distance between load centers ( $\alpha$ ) is longer in the TDO type.

- The spacer of the TDO type, or the TDI type, pre-adjusts the internal clearance to provide proper operating clearance after mounting.

### Single-row tapered roller bearings



Metric series

Bore diameter **15 – 360 mm**

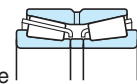


Inch series

(including J series metric bearing)

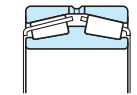
Bore diameter **9.525 – 292.100 mm**

### Double-row tapered roller bearings



TDO type

Bore diameter **25 – 500 mm**



TDI type

Bore diameter **100 – 500 mm**

[Note] When supplementary code "J" is added as a prefix (not a suffix) to bearing numbers (e.g. JHM720249/JHM720210), the bearings are not designed according to ISO 355. Such bearings are called "J series metric tapered roller bearings," and are produced according to special tolerances.



Boundary dimensions	<p>Metric single-row tapered roller bearings : as specified in JIS B 1512.</p> <p><b>Reference</b> JIS B 1512 specifies new dimension series which are based on ISO 355, as well as the conventional "3XX" dimension series. These new dimension series are as follows :</p> <p style="text-align: center;"><b>New dimension series</b></p> <div style="display: flex; justify-content: space-around;"> <div style="width: 45%;"> <p><b>(1) Angle series</b></p> <table border="1" style="width: 100%;"> <thead> <tr> <th rowspan="2">Angle series</th> <th colspan="2">Contact angle <math>\alpha</math></th> </tr> <tr> <th>over</th> <th>up to</th> </tr> </thead> <tbody> <tr><td>2</td><td>10°</td><td>13° 52'</td></tr> <tr><td>3</td><td>13° 52'</td><td>15° 59'</td></tr> <tr><td>4</td><td>15° 59'</td><td>18° 55'</td></tr> <tr><td>5</td><td>18° 55'</td><td>23°</td></tr> <tr><td>6</td><td>23°</td><td>27°</td></tr> <tr><td>7</td><td>27°</td><td>30°</td></tr> </tbody> </table> </div> <div style="width: 45%;"> <p><b>(3) Width series</b></p> <table border="1" style="width: 100%;"> <thead> <tr> <th rowspan="2">Width series</th> <th colspan="2"><math>T/\{(D-d)^{0.95}\}</math></th> </tr> <tr> <th>over</th> <th>up to</th> </tr> </thead> <tbody> <tr><td>B</td><td>0.50</td><td>0.68</td></tr> <tr><td>C</td><td>0.68</td><td>0.80</td></tr> <tr><td>D</td><td>0.80</td><td>0.88</td></tr> <tr><td>E</td><td>0.88</td><td>1.00</td></tr> </tbody> </table> </div> </div> <div style="margin-top: 10px;"> <p><b>(2) Diameter series</b></p> <table border="1" style="width: 100%;"> <thead> <tr> <th rowspan="2">Diameter series</th> <th colspan="2"><math>D/(d^{0.77})</math></th> </tr> <tr> <th>over</th> <th>up to</th> </tr> </thead> <tbody> <tr><td>B</td><td>3.40</td><td>3.80</td></tr> <tr><td>C</td><td>3.80</td><td>4.40</td></tr> <tr><td>D</td><td>4.40</td><td>4.70</td></tr> <tr><td>E</td><td>4.70</td><td>5.00</td></tr> <tr><td>F</td><td>5.00</td><td>5.60</td></tr> <tr><td>G</td><td>5.60</td><td>7.00</td></tr> </tbody> </table> </div> <p><b>[Remarks]</b>                      1. Combine these series symbols in the listed order to make the dimension series numbers. (ex. 2BC)                      2. Bearing numbers consist of a dimension series number and a bore diameter which is added as a suffix. (ex. 2BC080 : bore diameter 80 mm)</p>	Angle series	Contact angle $\alpha$		over	up to	2	10°	13° 52'	3	13° 52'	15° 59'	4	15° 59'	18° 55'	5	18° 55'	23°	6	23°	27°	7	27°	30°	Width series	$T/\{(D-d)^{0.95}\}$		over	up to	B	0.50	0.68	C	0.68	0.80	D	0.80	0.88	E	0.88	1.00	Diameter series	$D/(d^{0.77})$		over	up to	B	3.40	3.80	C	3.80	4.40	D	4.40	4.70	E	4.70	5.00	F	5.00	5.60	G	5.60	7.00
Angle series	Contact angle $\alpha$																																																															
	over	up to																																																														
2	10°	13° 52'																																																														
3	13° 52'	15° 59'																																																														
4	15° 59'	18° 55'																																																														
5	18° 55'	23°																																																														
6	23°	27°																																																														
7	27°	30°																																																														
Width series	$T/\{(D-d)^{0.95}\}$																																																															
	over	up to																																																														
B	0.50	0.68																																																														
C	0.68	0.80																																																														
D	0.80	0.88																																																														
E	0.88	1.00																																																														
Diameter series	$D/(d^{0.77})$																																																															
	over	up to																																																														
B	3.40	3.80																																																														
C	3.80	4.40																																																														
D	4.40	4.70																																																														
E	4.70	5.00																																																														
F	5.00	5.60																																																														
G	5.60	7.00																																																														
Tolerances	<ul style="list-style-type: none"> <li>· Metric series single-row tapered roller bearings as specified in JIS B 1514-1. ..... (refer to Table 7-5 on pp. A 66 – A 68.)</li> <li>· Metric series double-row tapered roller bearings as specified in BAS 1002. ..... (refer to Table 7-6 on p. A 69.)</li> <li>· Inch series tapered roller bearings as specified in ABMA Section 19. ..... (refer to Table 7-7 on pp. A 70, 71.)</li> <li>· J series metric tapered roller bearings the tolerance is specified separately. ..... (refer to Table 7-8 on pp. A 72, 73.)</li> </ul>																																																															
Internal clearance	Radial internal clearance of double-row, four-row and matched pair tapered roller bearings ..... (refer to Table 10-10 on p. A 110.)																																																															
Recommended fits	<ul style="list-style-type: none"> <li>· Metric series tapered roller bearings (classes 0, 6X and 6) ..... (refer to Table 9-4 on pp. A 91, 92.)</li> <li>· Inch series tapered roller bearings ..... (refer to Table 9-7 on pp. A 96, 97.)</li> <li>· J series metric tapered roller bearings ..... (refer to Table 9-6 on pp. A 94, 95.)</li> </ul>																																																															
Standard cage	Pressed steel cage (supplementary code : //) ( Some large size bearings have a pin type cage (FP) instead. ) ( They are listed separately in the bearing specification table. )																																																															

Allowable misalignment	Single-row tapered roller bearings : 0.000 9 rad (3') (If the misalignment exceeds this angle size, JTEKT is ready to design special bearings to order.)
Equivalent radial load	<p>■ Single-row tapered roller bearings</p> <p>Dynamic equivalent radial load <math>\left( \text{when } \frac{F_a}{F_r} \leq e \right) P_r = F_r</math>  <math>\left( \text{when } \frac{F_a}{F_r} &gt; e \right) P_r = 0.4F_r + Y_1 F_a</math></p> <p>Static equivalent radial load <math>P_{0r} = 0.5F_r + Y_0 F_a</math>                      when <math>P_{0r} &lt; F_r, P_{0r} = F_r</math></p> <p>[Note]                      Refer to the bearing specification table for the values of axial load factors <math>Y_1, Y_2, Y_3</math> and <math>Y_0</math> and constant <math>e</math>.</p> <p>■ Double-row or four-row tapered roller bearings</p> <p>Dynamic equivalent radial load <math>\left( \text{when } \frac{F_a}{F_r} \leq e \right) P_r = F_r + Y_2 F_a</math>  <math>\left( \text{when } \frac{F_a}{F_r} &gt; e \right) P_r = 0.67F_r + Y_3 F_a</math></p> <p>Static equivalent radial load <math>P_{0r} = F_r + Y_0 F_a</math></p>

**[Remarks]** 1. When two single-row tapered roller bearings are used together facing one another, an axial component of force is produced under radial load. In this case, refer to pp. A 38, 39 for calculation of the dynamic equivalent radial load.  
 2. When the load is too small, slippage occurs between the rollers and raceways, causing smearing to develop. This also occurs to matched pair bearings when the ratio of axial load to radial load exceeds the value  $e$  shown in the specification table ( $F_a/F_r > e$ ). Consult with JTEKT on use of bearings under such conditions.



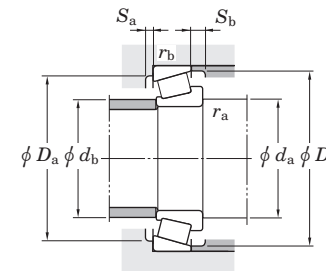
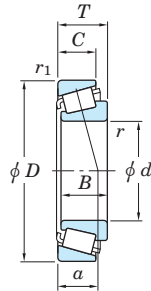






Single-row tapered roller bearings  
metric series

$d$  (35) ~ (45) mm

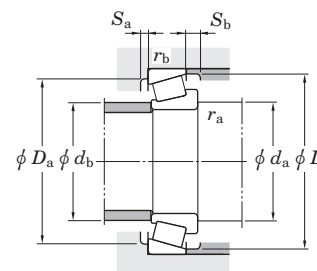
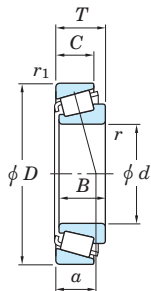


Boundary dimensions (mm)						Basic load ratings (kN)		Fatigue load limit (kN)	Limiting speeds (min <sup>-1</sup> )		Bearing No. <sup>1)</sup>	Dimension series to ISO355 (Refer.)	Load center (mm) a	Mounting dimensions (mm)								Constant e	Axial load factors		(Refer.) Mass (kg)		
d	D	T	B	C	r min.	r1 min.	Cr	C0r	Cu	Grease lub.				Oil lub.	da min.	db max.	Da max.	Db min.	Sa min.	Sb min.	ra max.		rb max.	Y1		Y0	
35	80	32.75	31	25	2	1.5	121	123	18.0	5 200	7 000	—	23.8	45	44	70	60	75	3	7.5	2	1.5	0.47	1.27	0.70	0.830	
	80	32.75	31	25	2	1.5	126	114	17.3	5 300	7 000			2FE	20.6	45	44	70	66	74	3	7.5	2	1.5	0.31	1.90	1.05
40	62	15	15	12	0.6	0.6	42.1	48.5	6.90	5 900	7 800	2BC	11.9	44.5	45	57.5	55	59	3	3	0.6	0.6	0.29	2.07	1.14	0.164	
	68	19	19	14.5	1	1	67.2	71.4	10.3	5 600	7 400	3CD	15.1	45.5	46	62.5	60	65	4	4.5	1	1	0.38	1.58	0.87	0.282	
	68	22	22	18	1	1	75.9	84.6	12.4	5 500	7 400	2BE	14.7	45.5	46	62.5	60	65	3	4	1	1	0.28	2.12	1.17	0.326	
	75	26	26	20.5	1.5	1.5	103	108	16.1	5 200	6 900	2CE	18.3	48.5	47	66.5	65	71	4	5.5	1.5	1.5	0.36	1.69	0.93	0.508	
	80	19.75	18	15	1.5	1.5	76.6	67.4	9.90	5 000	6 700	—	20.2	48.5	49	71.5	66	76	3	4.5	1.5	1.5	0.55	1.10	0.60	0.445	
	80	19.75	18	16	1.5	1.5	78.4	69.2	10.3	5 000	6 700	3DB	17.0	48.5	49	71.5	69	75	3	3.5	1.5	1.5	0.37	1.60	0.88	0.434	
	80	24.75	23	19	1.5	1.5	98.0	93.1	13.7	5 000	6 700	5DC	22.0	48.5	48	71.5	64	76	3	5.5	1.5	1.5	0.55	1.10	0.60	0.570	
	80	24.75	23	19	1.5	1.5	97.0	90.8	13.6	5 000	6 600	3DC	19.4	48.5	48	71.5	68	75	3	5.5	1.5	1.5	0.37	1.60	0.88	0.554	
	80	32	32	25	1.5	1.5	135	139	20.8	5 000	6 700	2DE	20.7	48.5	47	71.5	67	76	5	7	1.5	1.5	0.36	1.68	0.92	0.758	
	85	33	32.5	28	2.5	2	143	143	21.6	4 800	6 400	2EE	21.9	52	48	75	70	80	5	5	2	2	0.34	1.74	0.96	0.900	
	90	25.25	23	17	2	1.5	100	90.2	13.1	3 800	5 300	7FB	29.9	50	51	80	71	86.5	3	8	2	1.5	0.83	0.73	0.40	0.757	
	90	25.25	23	20	2	1.5	109	98.5	14.8	4 600	6 100	—	23.8	50	53	80	72	84	3	5	2	1.5	0.55	1.10	0.60	0.780	
	90	25.25	23	20	2	1.5	113	101	15.5	4 500	6 100	30308JR	2FB	19.9	50	52	80	77	82	3	5	2	1.5	0.35	1.74	0.96	0.757
	90	35.25	33	26	2	1.5	140	138	20.2	4 700	6 200	TR0809AR	—	27.5	50	49	80	67	85	3	9	2	1.5	0.55	1.10	0.60	1.10
	90	35.25	33	27	2	1.5	145	139	21.3	4 600	6 200	32308JR	2FD	24.3	50	50	80	73	82	3	8	2	1.5	0.35	1.74	0.96	1.06
45	68	15	15	12	0.6	0.6	43.5	52.4	7.45	5 300	7 100	2BC	12.5	49.5	50	63.5	61	64	3	3	0.6	0.6	0.32	1.88	1.04	0.190	
	75	20	20	15.5	1	1	78.8	86.5	12.6	5 000	6 600	3CC	16.5	50.5	51	69.5	67	72	4	4.5	1	1	0.39	1.53	0.84	0.354	
	75	24	24	19	1	1	87.4	101	14.9	5 000	6 700	2CE	16.4	50.5	51	69.5	67	71	4	5	1	1	0.29	2.04	1.12	0.416	
	80	26	26	20.5	1.5	1.5	110	120	17.9	4 800	6 400	3CE	19.4	53.5	52	71.5	69	76.5	4	5.5	1.5	1.5	0.38	1.57	0.86	0.563	
	85	20.75	19	15	1.5	1.5	83.1	77.0	11.4	4 600	6 100	—	21.1	53.5	54	76.5	71	80	4	5.5	1.5	1.5	0.55	1.10	0.60	0.500	
	85	20.75	19	16	1.5	1.5	83.9	77.4	11.6	4 600	6 100	3DB	18.9	53.5	54	76.5	74	80	3	4.5	1.5	1.5	0.40	1.48	0.81	0.502	
	85	24.75	23	19	1.5	1.5	101	102	15.1	4 600	6 200	—	23.0	53.5	53	76.5	69	81	3	5.5	1.5	1.5	0.55	1.10	0.60	0.625	
	85	24.75	23	19	1.5	1.5	105	104	15.6	4 600	6 100	32209CR	3DC	20.3	53.5	53	76.5	73	81	3	5.5	1.5	1.5	0.40	1.48	0.81	0.597
	85	32	32	25	1.5	1.5	139	149	22.3	4 600	6 200	33209JR	3DE	21.8	53.5	52	76.5	72	81	5	7	1.5	1.5	0.39	1.56	0.86	0.818
	95	29	26.5	20	2.5	2.5	118	118	17.0	3 600	5 100	T7FC045	7FC	32.6	57	54	83	71	91	3	9	2	2	0.87	0.69	0.38	0.943
	95	36	35	30	2.5	2.5	175	177	27.2	4 300	5 700	T2ED045	2ED	23.8	57	55	83	80	89	6	6	2	2	0.32	1.86	1.02	1.20

[Note] 1) Please consult with JTEKT when using the bearings identified by suffix C. They are medium-tapered types especially designed for special purposes.

Single-row tapered roller bearings  
metric series

d (45) ~ (55) mm

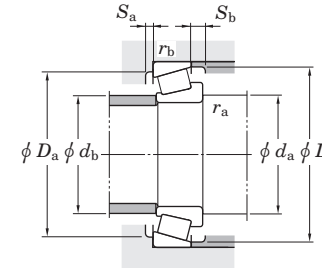
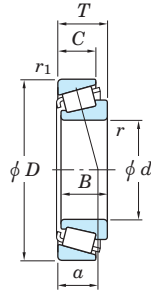


Boundary dimensions (mm)						Basic load ratings (kN)		Fatigue load limit (kN)	Limiting speeds (min <sup>-1</sup> )		Bearing No. <sup>1)</sup>	Dimension series to ISO355 (Refer.)	Load center (mm) a	Mounting dimensions (mm)								Constant e	Axial load factors		(Refer.) Mass (kg)	
d	D	T	B	C	r <sub>min.</sub>	r <sub>1 min.</sub>	C <sub>r</sub>	C <sub>0r</sub>	C <sub>u</sub>	Grease lub.				Oil lub.	d <sub>a min.</sub>	d <sub>b max.</sub>	D <sub>a max.</sub>	D <sub>b min.</sub>	S <sub>a min.</sub>	S <sub>b min.</sub>	r <sub>a max.</sub>		r <sub>b max.</sub>	Y <sub>1</sub>		Y <sub>0</sub>
45	100	27.25	25	18	2	1.5	119	107	15.8	3 400	4 700	7FB	32.9	55	56	90	79	96	3	9	2	1.5	0.83	0.73	0.40	0.973
	100	27.25	25	20	2	1.5	136	119	18.1	4 100	5 500	—	25.7	55	57	90	81	94	4	7	2	1.5	0.55	1.10	0.60	1.00
	100	27.25	25	22	2	1.5	141	128	19.9	4 100	5 400	2FB	21.3	55	59	90	86	93	3	5	2	1.5	0.35	1.74	0.96	1.01
	100	38.25	36	29	2	1.5	181	182	27.0	4 200	5 600	—	30.3	55	56	90	76	95	4	9	2	1.5	0.55	1.10	0.60	1.45
	100	38.25	36	30	2	1.5	183	180	27.7	4 100	5 500	2FD	26.8	55	56	90	82	93	3	8	2	1.5	0.35	1.74	0.96	1.43
50	72	15	15	12	0.6	0.6	45.0	56.3	8.00	4 900	6 600	2BC	13.7	54.5	55	67.5	65	69	3	3	0.6	0.6	0.34	1.76	0.97	0.195
	80	20	20	15.5	1	1	82.7	94.5	13.8	4 600	6 100	3CC	17.7	55.5	56	74.5	72	77	4	4.5	1	1	0.42	1.42	0.78	0.389
	80	24	24	19	1	1	91.8	110	16.3	4 600	6 100	2CE	17.4	55.5	56	74.5	72	76	4	5	1	1	0.32	1.90	1.04	0.451
	85	26	26	20	1.5	1.5	112	127	18.9	4 400	5 900	3CE	20.6	58.5	56	76.5	74	81.5	4	6	1.5	1.5	0.41	1.46	0.80	0.594
	90	21.75	20	16	1.5	1.5	96.7	95.8	14.3	4 300	5 700	—	22.7	58.5	58	81.5	76	86	4	5.5	1.5	1.5	0.55	1.10	0.60	0.590
	90	21.75	20	17	1.5	1.5	95.6	91.7	13.8	4 300	5 700	3DB	20.1	58.5	58	81.5	79	85	3	4.5	1.5	1.5	0.42	1.43	0.79	0.566
	90	24.75	23	19	1.5	1.5	106	113	16.7	4 300	5 700	—	24.0	58.5	58	81.5	74	86	3	5.5	1.5	1.5	0.55	1.10	0.60	0.675
	90	24.75	23	19	1.5	1.5	106	105	15.9	4 300	5 700	3DC	20.6	58.5	58	81.5	78	85	3	5.5	1.5	1.5	0.42	1.43	0.79	0.643
	90	32	32	24.5	1.5	1.5	150	167	25.0	4 300	5 700	3DE	23.1	58.5	57	81.5	77	86.5	5	7.5	1.5	1.5	0.41	1.45	0.80	0.887
	100	36	35	30	2.5	2.5	196	196	30.2	4 100	5 400	2ED	24.5	62	58	88	84	94	6	6	2	2	0.34	1.75	0.96	1.28
	105	32	29	22	3	3	141	140	20.3	3 300	4 600	7FC	35.9	64	59	91	78	100	4	10	2.5	2.5	0.87	0.69	0.38	1.25
	110	29.25	27	19	2.5	2	144	133	19.8	3 100	4 300	7FB	35.0	62	62	98	87	105	3	10	2	2	0.83	0.73	0.40	1.25
	110	29.25	27	20	2.5	2	155	143	21.9	3 700	4 900	—	27.5	62	64	98	90	103	4	9	2	2	0.55	1.10	0.60	1.25
	110	29.25	27	23	2.5	2	172	152	24.0	3 700	4 900	2FB	22.9	62	65	98	95	102	3	6	2	2	0.35	1.74	0.96	1.32
	110	42.25	40	33	2.5	2	214	234	34.6	3 800	5 100	5FD	33.4	62	61	98	81	103	4	9	2	2	0.55	1.10	0.60	2.00
110	42.25	40	33	2.5	2	221	220	34.2	3 700	5 000	2FD	29.4	62	62	98	90	102	3	9	2	2	0.35	1.74	0.96	1.89	
55	80	17	17	14	1	1	55.8	73.3	10.6	4 400	5 900	2BC	14.5	61	61	74	72	76	3	3	1	1	0.31	1.94	1.07	0.285
	90	23	23	17.5	1.5	1.5	106	121	18.2	4 100	5 500	3CC	19.8	63.5	63	81.5	81	86	4	5.5	1.5	1.5	0.41	1.48	0.81	0.569
	90	27	27	21	1.5	1.5	121	149	22.6	4 100	5 400	2CE	19.3	63.5	63	81.5	81	86	5	6	1.5	1.5	0.31	1.92	1.06	0.672
	95	30	30	23	1.5	1.5	145	161	24.6	4 000	5 300	3CE	22.5	63.5	62	86.5	83	91	5	7	1.5	1.5	0.37	1.60	0.88	0.868
	100	22.75	21	17	2	1.5	112	108	16.2	3 900	5 200	—	24.3	65	63	90	84	95	4	5.5	2	1.5	0.55	1.10	0.60	0.750
	100	22.75	21	18	2	1.5	118	113	17.3	3 900	5 200	3DB	20.7	65	64	90	88	94	4	4.5	2	1.5	0.40	1.48	0.81	0.732
	100	26.75	25	21	2	1.5	134	135	20.4	3 900	5 200	—	25.9	65	64	90	83	96	4	5.5	2	1.5	0.55	1.10	0.60	0.875

[Note] 1) Please consult with JTEKT when using the bearings identified by suffix C. They are medium-tapered types especially designed for special purposes.

Single-row tapered roller bearings  
metric series

d (55) ~ (65) mm

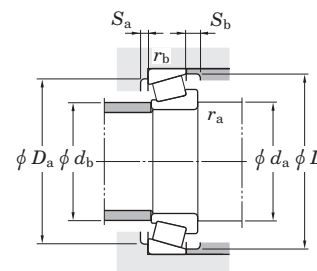
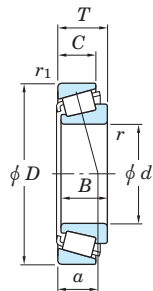


Boundary dimensions (mm)						Basic load ratings (kN)		Fatigue load limit (kN) $C_u$	Limiting speeds ( $\text{min}^{-1}$ )		Bearing No. <sup>1)</sup>	Dimension series to ISO355 (Refer.)	Load center (mm) $a$	Mounting dimensions (mm)								Constant $e$	Axial load factors		(Refer.) Mass (kg)		
$d$	$D$	$T$	$B$	$C$	$r_{\text{min}}$	$r_{1\text{min}}$	$C_r$		$C_{0r}$	Grease lub.				Oil lub.	$d_a$ min.	$d_b$ max.	$D_a$ max.	$D_b$ min.	$S_a$ min.	$S_b$ min.	$r_a$ max.		$r_b$ max.	$Y_1$		$Y_0$	
55	100	26.75	25	21	2	1.5	134	133	20.5	3 900	5 200	32211JR-1	3DC	23.0	65	63	90	87	95	4	5.5	2	1.5	0.40	1.48	0.81	0.863
	100	35	35	27	2	1.5	178	189	28.9	3 900	5 200	33211JR	3DE	25.3	65	62	90	85	96	6	8	2	1.5	0.40	1.50	0.83	1.18
	115	34	31	23.5	3	3	161	164	23.9	3 000	4 200	T7FC055	7FC	38.6	69	65	101	86	109	4	10.5	2.5	2.5	0.87	0.69	0.38	1.59
	120	31.5	29	21	2.5	2	161	148	22.3	2 900	4 000	30311DJR	7FB	38.4	67	68	108	94	113	4	10.5	2	2	0.83	0.73	0.40	1.59
	120	31.5	29	22	2.5	2	180	161	24.8	3 400	4 500	30311CR	—	29.8	67	70	108	97	112	4.5	9.5	2	2	0.55	1.10	0.60	1.58
	120	31.5	29	25	2.5	2	187	170	27.0	3 300	4 500	30311JR	2FB	25.5	67	71	108	104	111	4	6.5	2	2	0.35	1.74	0.96	1.65
	120	45.5	43	35	2.5	2	230	247	36.9	3 400	4 600	32311C	5FD	35.9	67	67	108	90	113	4	10	2	2	0.55	1.10	0.60	2.45
	120	45.5	43	35	2.5	2	214	203	31.8	3 400	4 500	32311J	2FD	32.4	67	68	108	99	111	4	10.5	2	2	0.35	1.74	0.96	2.24
	120	45.5	43	35	2.5	2	250	250	39.1	3 400	4 500	32311JR	2FD	32.4	67	68	108	99	111	4	10.5	2	2	0.35	1.74	0.96	2.38
	60	85	17	17	14	1	1	57.6	78.2	11.3	4 100	5 500	32912JR	2BC	15.6	65.5	66	79.5	77	81	3	3	1	1	0.33	1.81	1.00
95		23	23	17.5	1.5	1.5	108	127	19.0	3 900	5 200	32012JR	4CC	21.0	68.5	67	86.5	85	91	4	5.5	1.5	1.5	0.43	1.39	0.77	0.621
95		27	27	21	1.5	1.5	127	162	24.5	3 900	5 200	3012JR	2CE	20.1	68.5	67	86.5	85	90	5	6	1.5	1.5	0.33	1.83	1.01	0.719
100		30	30	23	1.5	1.5	149	170	25.9	3 700	5 000	33112JR	3CE	23.7	68.5	67	91.5	88	96	5	7	1.5	1.5	0.40	1.51	0.83	0.923
110		23.75	22	17	2	1.5	127	123	18.8	3 500	4 700	30212CR	—	26.2	70	70	100	93	104	4	6.5	2	1.5	0.55	1.10	0.60	0.930
110		23.75	22	19	2	1.5	133	127	19.7	3 500	4 700	30212JR	3EB	21.9	70	70	100	96	103	4	4.5	2	1.5	0.40	1.48	0.81	0.945
110		29.75	28	22	2	1.5	160	164	25.1	3 600	4 700	32212CR	—	28.6	70	68	100	91	105	4	7.5	2	1.5	0.55	1.10	0.60	1.20
110		29.75	28	24	2	1.5	164	167	25.9	3 500	4 700	32212JR	3EC	25.1	70	69	100	95	104	4	5.5	2	1.5	0.40	1.48	0.81	1.19
110		38	38	29	2	1.5	217	239	36.6	3 600	4 700	33212JR	3EE	27.2	70	69	100	93	105	6	9	2	1.5	0.40	1.48	0.82	1.57
115		39	38	31	4	2.5	198	227	34.0	3 400	4 600	T5ED060	5ED	32.4	78	70	103	92	110	5	8	3	2	0.53	1.13	0.62	1.81
115		40	39	33	2.5	2.5	229	242	37.7	3 400	4 600	T2EE060	2EE	27.6	72	70	103	98	109	6	7	2	2	0.33	1.80	0.99	1.80
125		37	33.5	26	3	3	191	194	28.8	2 800	3 900	T7FC060	7FC	40.8	74	71	111	94	119	4	11	2.5	2.5	0.82	0.73	0.40	2.03
130		33.5	31	22	3	2.5	191	179	27.1	2 600	3 700	30312DJR	7FB	40.8	74	73	118	103	124	4	11.5	2.5	2	0.83	0.73	0.40	2.01
130		33.5	31	23	3	2.5	211	196	30.5	3 100	4 200	30312CR	—	31.9	74	75	118	105	121	5	10.5	2.5	2	0.55	1.10	0.60	1.99
130		33.5	31	26	3	2.5	217	201	31.9	3 100	4 100	30312JR	2FB	26.9	74	77	118	112	120	4	7.5	2.5	2	0.35	1.74	0.96	2.08
130		48.5	46	37	3	2.5	286	310	41.4	3 200	4 300	32312CR	5FD	38.3	74	73	118	98	122	5	11	2.5	2	0.55	1.10	0.60	3.15
130		48.5	46	37	3	2.5	277	275	38.6	3 100	4 200	32312J	2FD	32.3	74	74	118	107	120	4	11.5	2.5	2	0.35	1.74	0.96	2.87
130		48.5	46	37	3	2.5	306	315	44.1	3 100	4 200	32312JR	2FD	32.3	74	74	118	107	120	4	11.5	2.5	2	0.35	1.74	0.96	2.99
65	90	17	17	14	1	1	59.2	83.1	12.0	3 900	5 200	32913JR	2BC	16.8	70.5	70	84.5	81	86	3	3	1	1	0.35	1.70	0.93	0.327

[Note] 1) Please consult with JTEKT when using the bearings identified by suffix C. They are medium-tapered types especially designed for special purposes.

# Single-row tapered roller bearings metric series

$d$  (65) ~ (70) mm

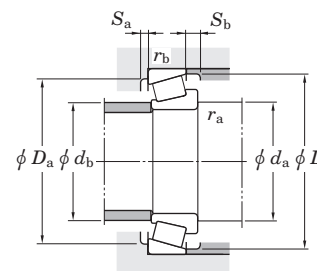
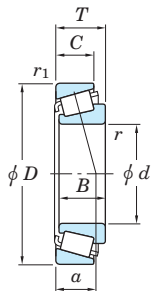


Boundary dimensions (mm)						Basic load ratings (kN)		Fatigue load limit (kN) $C_u$	Limiting speeds ( $\text{min}^{-1}$ )		Bearing No. <sup>1)</sup>	Dimension series to ISO355 (Refer.)	Load center (mm) $a$	Mounting dimensions (mm)								Constant $e$	Axial load factors		(Refer.) Mass (kg)			
$d$	$D$	$T$	$B$	$C$	$r_{\text{min}}$	$r_{1\text{min}}$	$C_r$		$C_{0r}$	Grease lub.				Oil lub.	$d_a$ min.	$d_b$ max.	$D_a$ max.	$D_b$ min.	$S_a$ min.	$S_b$ min.	$r_a$ max.		$r_b$ max.	$Y_1$		$Y_0$		
65	100	23	23	17.5	1.5	1.5	113	137	20.6	3 600	4 800	32013JR	4CC	22.5	73.5	72	91.5	90	97	4	5.5	1.5	1.5	0.46	1.31	0.72	0.664	
	100	27	27	21	1.5	1.5	129	169	25.5	3 600	4 800	33013JR	2CE	21.1	73.5	72	91.5	89	96	5	6	1.5	1.5	0.35	1.72	0.95	0.762	
	110	34	34	26.5	1.5	1.5	191	223	34.3	3 400	4 600	33113JR	3DE	25.9	73.5	73	101.5	96	106	6	7.5	1.5	1.5	0.39	1.55	0.85	1.33	
	120	24.75	23	18	2	1.5	145	139	21.5	3 200	4 300	30213CR	—	28.1	75	77	110	102	114	4	6.5	2	1.5	0.55	1.10	0.60	1.15	
	120	24.75	23	20	2	1.5	160	156	24.3	3 200	4 300	30213JR	3EB	24.2	75	77	110	106	113	4	4.5	2	1.5	0.40	1.48	0.81	1.18	
	120	32.75	31	24	2	1.5	190	198	30.4	3 200	4 300	32213CR	—	31.3	75	75	110	99	114	4	8.5	2	1.5	0.55	1.10	0.60	1.55	
	120	32.75	31	27	2	1.5	196	203	31.7	3 200	4 300	32213JR	3EC	26.6	75	76	110	104	115	4	5.5	2	1.5	0.40	1.48	0.81	1.58	
	120	39	38	31	4	2.5	190	232	34.7	3 200	4 300	T5ED065	5ED	34.1	83	75	108	96	115	5	8	3	2	0.56	1.07	0.59	1.93	
	120	41	41	32	2	1.5	250	277	43.0	3 200	4 300	33213JR	3EE	30.0	75	74	110	102	115	7	9	2	1.5	0.39	1.54	0.85	2.02	
	130	37	33.5	26	3	3	186	211	31.2	2 600	3 600	T7FC065	7FC	44.4	79	78	116	98	124	4	11	2.5	2.5	0.87	0.69	0.38	2.17	
	140	36	33	23	3	2.5	220	209	31.4	2 400	3 400	30313DJR	7GB	44.3	79	79	128	111	133	4	13	2.5	2	0.83	0.73	0.40	2.44	
	140	36	33	25	3	2.5	241	227	35.1	2 900	3 900	30313CR	—	34.3	79	81	128	113	130	5	11	2.5	2	0.55	1.10	0.60	2.44	
	140	36	33	28	3	2.5	255	239	37.6	2 800	3 800	30313JR	2GB	29.3	79	83	128	122	130	4	8	2.5	2	0.35	1.74	0.96	2.56	
	140	51	48	39	3	2.5	322	361	49.0	2 900	3 900	32313CR	5GD	40.9	79	79	128	106	131	5	12	2.5	2	0.55	1.10	0.60	3.85	
	140	51	48	39	3	2.5	313	312	43.4	2 900	3 900	32313J	2GD	34.7	79	80	128	117	130	4	12	2.5	2	0.35	1.74	0.96	3.49	
	140	51	48	39	3	2.5	346	357	49.6	2 900	3 900	32313JR	2GD	34.7	79	80	128	117	130	4	12	2.5	2	0.35	1.74	0.96	3.64	
	70	100	20	20	16	1	1	89.0	115	17.2	3 500	4 700	32914JR	2BC	17.8	75.5	77	94.5	91	96	4	4	1	1	0.32	1.90	1.05	0.496
		110	25	25	19	1.5	1.5	136	163	24.8	3 300	4 400	32014JR	4CC	23.6	78.5	78	101.5	98	105	5	6	1.5	1.5	0.43	1.38	0.76	0.884
110		31	31	25.5	1.5	1.5	168	208	32.3	3 300	4 400	33014JR	2CE	22.1	78.5	78	101.5	99	105	5	5.5	1.5	1.5	0.28	2.11	1.16	1.09	
120		37	37	29	2	1.5	227	266	41.2	3 100	4 200	33114JR	3DE	28.0	80	79	110	104	115	6	8	2	1.5	0.38	1.58	0.87	1.71	
125		26.25	24	19	2	1.5	158	158	24.5	3 000	4 000	30214CR	—	29.9	80	82	116.5	107	119	4	7	2	1.5	0.55	1.10	0.60	1.30	
125		26.25	24	21	2	1.5	173	173	27.1	3 100	4 100	30214JR	3EB	25.9	80	81	116.5	110	118	4	5	2	1.5	0.42	1.43	0.79	1.32	
125		33.25	31	24	2	1.5	197	212	32.6	3 100	4 100	32214CR	—	32.6	80	80	116.5	104	120	4	9.5	2	1.5	0.55	1.10	0.60	1.65	
125		33.25	31	27	2	1.5	212	225	35.2	3 100	4 100	32214JR	3EC	29.2	80	80	116.5	108	119	4	6	2	1.5	0.42	1.43	0.79	1.71	
125		41	41	32	2	1.5	258	294	45.5	3 100	4 100	33214JR	3EE	31.2	80	79	116.5	107	120	7	9	2	1.5	0.41	1.47	0.81	2.16	
130		43	42	35	3	2.5	291	319	50.0	3 000	4 000	T2ED070	2ED	30.2	84	81	118	111	123	1	1	2.5	2	0.33	1.80	0.99	2.48	
140		39	35.5	27	3	3	222	242	35.8	2 400	3 400	T7FC070	7FC	46.5	84	82	126	106	133	5	12	2.5	2.5	0.87	0.69	0.38	2.64	
140		52	51	43	5	3	330	382	51.6	2 900	3 800	T4FE070	4FE	37.7	92	82	126	111	133	7	9	4	2.5	0.45	1.34	0.74	3.69	

[Note] 1) Please consult with JTEKT when using the bearings identified by suffix C. They are medium-tapered types especially designed for special purposes.

Single-row tapered roller bearings  
metric series

d (70) ~ (80) mm

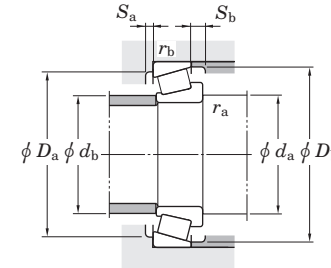
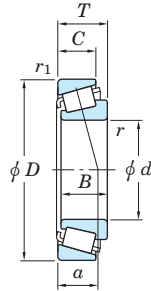


Boundary dimensions (mm)						Basic load ratings (kN)		Fatigue load limit (kN) Cu	Limiting speeds (min <sup>-1</sup> )		Bearing No. <sup>1)</sup>	Dimension series to ISO355 (Refer.)	Load center (mm) a	Mounting dimensions (mm)								Constant e	Axial load factors		(Refer.) Mass (kg)		
d	D	T	B	C	r min.	r1 min.	Cr		C0r	Grease lub.				Oil lub.	da min.	db max.	Da max.	Db min.	Sa min.	Sb min.	ra max.		rb max.	Y1		Y0	
70	150	38	35	25	3	2.5	246	235	34.9	2 300	3 200	30314DJR	7GB	47.1	84	84	138	118	142	4	13	2.5	2	0.83	0.73	0.40	2.97
	150	38	35	30	3	2.5	280	256	36.0	2 700	3 600	30314CR	—	37.0	84	87	138	123	141	6	8	2.5	2	0.55	1.10	0.60	3.10
	150	38	35	30	3	2.5	288	273	42.2	2 600	3 500	30314JR	2GB	30.5	84	89	138	130	140	4	8	2.5	2	0.35	1.74	0.96	3.08
	150	54	51	42	3	2.5	321	315	44.1	2 700	3 600	32314	—	37.0	84	86	138	125	140	4	12	2.5	2	0.35	1.73	0.95	4.11
	150	54	51	42	3	2.5	371	391	51.4	2 700	3 600	32314C	5GD	44.4	84	84	138	115	142	5	12	2.5	2	0.55	1.10	0.60	4.50
	150	54	51	42	3	2.5	396	414	57.2	2 700	3 600	32314JR	2GD	37.4	84	86	138	125	140	4	12	2.5	2	0.35	1.74	0.96	4.50
75	105	20	20	16	1	1	92.2	123	18.4	3 300	4 400	32915JR	2BC	18.9	80.5	81	99.5	96	101	4	4	1	1	0.33	1.80	0.99	0.526
	115	25	25	19	1.5	1.5	139	169	25.8	3 100	4 200	32015JR	4CC	25.1	83.5	83	106.5	103	110	5	6	1.5	1.5	0.46	1.31	0.72	0.930
	115	31	31	25.5	1.5	1.5	177	225	35.0	3 200	4 200	33015JR	2CE	22.9	83.5	83	106.5	104	110	6	5.5	1.5	1.5	0.30	2.01	1.11	1.16
	125	37	37	29	2	1.5	234	280	43.4	3 000	4 000	33115JR	3DE	29.3	85	84	116.5	109	120	6	8	2	1.5	0.40	1.51	0.83	1.84
	130	27.25	25	20	2	1.5	171	178	27.4	2 900	3 800	30215CR	—	31.0	85	87	121.5	111	124	5	7	2	1.5	0.55	1.10	0.60	1.40
	130	27.25	25	22	2	1.5	178	181	28.2	2 900	3 900	30215JR	4DB	27.6	85	86	121.5	115	124	4	5	2	1.5	0.44	1.38	0.76	1.42
	130	33.25	31	24	2	1.5	204	225	34.5	2 900	3 900	32215CR	—	33.7	85	85	121.5	109	125	4	9	2	1.5	0.55	1.10	0.60	1.75
	130	33.25	31	27	2	1.5	218	234	36.4	2 900	3 900	32215JR	4DC	30.2	85	85	121.5	114	125	4	6	2	1.5	0.44	1.38	0.76	1.77
	130	41	41	31	2	1.5	266	310	47.7	2 900	3 900	33215JR	3EE	32.5	85	83	121.5	111	125	7	10	2	1.5	0.43	1.40	0.77	2.26
	150	42	38	29	3	3	240	270	39.0	2 200	3 100	T7FC075	7FC	50.6	89	89	136	114	143	5	13	2.5	2.5	0.87	0.69	0.38	3.24
	160	40	37	26	3	2.5	266	254	34.2	2 100	2 900	30315DJR	7GB	49.9	89	91	148	127	151	6	14	2.5	2	0.83	0.73	0.40	3.45
	160	40	37	26	3	2.5	277	266	36.9	2 100	2 900	30315DR	—	48.8	89	91	148	127	151	6	14	2.5	2	0.81	0.74	0.41	3.48
	160	40	37	31	3	2.5	310	296	42.1	2 500	3 400	30315CR	—	39.2	89	94	148	130	150	6	9	2.5	2	0.55	1.10	0.60	3.80
	160	40	37	31	3	2.5	325	311	44.9	2 500	3 300	30315JR	2GB	32.5	89	95	148	139	149	4	9	2.5	2	0.35	1.74	0.96	3.65
	160	40	37	31	3	2.5	313	298	43.3	2 500	3 300	30315R	—	31.9	89	95	148	139	149	4	9	2.5	2	0.35	1.73	0.95	3.52
	160	58	55	43	3	2.5	447	474	61.4	2 500	3 400	32315CR	—	46.6	89	90	148	125	154	6	15	2.5	2	0.55	1.10	0.60	5.50
	160	58	55	45	3	2.5	454	481	64.6	2 500	3 300	32315JR	2GD	40.0	89	91	148	133	149	4	13	2.5	2	0.35	1.74	0.96	5.41
	160	58	55	45	3	2.5	425	444	60.3	2 500	3 300	32315R	—	39.5	89	91	148	133	149	4	13	2.5	2	0.35	1.73	0.95	5.30
80	110	20	20	16	1	1	95.1	131	19.5	3 100	4 200	32916JR	2BC	20.1	85.5	86	104.5	101	106	4	4	1	1	0.35	1.71	0.94	0.556
	125	29	29	22	1.5	1.5	185	225	34.6	2 900	3 900	32016JR	3CC	26.7	88.5	89	116.5	112	120	6	7	1.5	1.5	0.42	1.42	0.78	1.32
	125	36	36	29.5	1.5	1.5	218	288	44.8	2 900	3 900	33016JR	2CE	25.1	88.5	90	116.5	112	119	6	6.5	1.5	1.5	0.28	2.16	1.19	1.63
	130	37	37	29	2	1.5	240	294	44.9	2 800	3 800	33116JR	3DE	30.5	90	89	121.5	114	126	6	8	2	1.5	0.42	1.44	0.79	1.93

[Note] 1) Please consult with JTEKT when using the bearings identified by suffix C. They are medium-tapered types especially designed for special purposes.

Single-row tapered roller bearings  
metric series

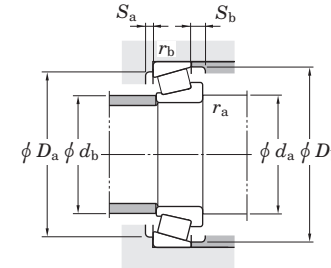
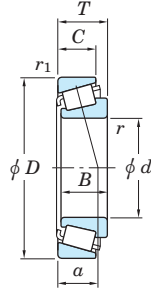
*d* (80) ~ (90) mm



Boundary dimensions (mm)						Basic load ratings (kN)		Fatigue load limit (kN) <i>C<sub>u</sub></i>	Limiting speeds (min <sup>-1</sup> )		Bearing No.	Dimension series to ISO355 (Refer.)	Load center (mm) <i>a</i>	Mounting dimensions (mm)								Constant <i>e</i>	Axial load factors		(Refer.) Mass (kg)			
<i>d</i>	<i>D</i>	<i>T</i>	<i>B</i>	<i>C</i>	<i>r</i> <sub>min.</sub>	<i>r</i> <sub>1 min.</sub>	<i>C<sub>r</sub></i>		<i>C<sub>0r</sub></i>	Grease lub.				Oil lub.	<i>d<sub>a</sub></i> min.	<i>d<sub>b</sub></i> max.	<i>D<sub>a</sub></i> max.	<i>D<sub>b</sub></i> min.	<i>S<sub>a</sub></i> min.	<i>S<sub>b</sub></i> min.	<i>r<sub>a</sub></i> max.		<i>r<sub>b</sub></i> max.	<i>Y</i> <sub>1</sub>		<i>Y</i> <sub>0</sub>		
80	140	28.25	26	22	2.5	2	202	202	31.2	2 700	3 600	30216JR	3EB	28.6	92	91	130	124	132	4	6	2	2	0.42	1.43	0.79	1.72	
	140	35.25	33	28	2.5	2	253	271	41.5	2 700	3 600	32216JR	3EC	31.7	92	90	130	122	134	4	7	2	2	0.42	1.43	0.79	2.17	
	140	46	46	35	2.5	2	313	371	56.1	2 700	3 600	33216JR	3EE	35.7	92	89	130	119	135	7	11	2	2	0.43	1.41	0.78	2.99	
	145	46	45	38	3	2.5	333	381	52.0	2 600	3 500	T2ED080	2ED	32.7	94	92	133	125	137	7	8	2.5	2	0.32	1.88	1.03	3.20	
	170	42.5	39	27	3	2.5	294	282	38.7	2 000	2 800	30316DJR	7GB	53.5	94	97	158	134	159	6	15.5	2.5	2	0.83	0.73	0.40	4.12	
	170	42.5	39	33	3	2.5	368	355	49.9	2 300	3 100	30316JR	2GB	34.8	94	102	158	148	159	4	9.5	2.5	2	0.35	1.74	0.96	4.46	
	170	42.5	39	33	3	2.5	345	330	47.1	2 300	3 100	30316R	—	33.9	94	102	158	148	159	4	9.5	2.5	2	0.35	1.73	0.95	4.26	
	170	61.5	58	48	3	2.5	434	440	58.6	2 300	3 100	32316J	2GD	43.5	94	98	158	142	159	4	13.5	2.5	2	0.35	1.74	0.96	6.04	
	170	61.5	58	48	3	2.5	480	503	67.0	2 300	3 100	32316JR	2GD	43.5	94	98	158	142	159	4	13.5	2.5	2	0.35	1.74	0.96	6.31	
	85	120	23	23	18	1.5	1.5	122	165	25.0	2 900	3 900	32917JR	2BC	21.2	93.5	93	111.5	109	115	5	5	1.5	1.5	0.33	1.83	1.01	0.794
130		29	29	22	1.5	1.5	189	234	35.5	2 800	3 700	32017JR	4CC	28.0	93.5	94	121.5	117	125	6	7	1.5	1.5	0.44	1.36	0.75	1.38	
130		36	36	29.5	1.5	1.5	222	300	46.0	2 800	3 700	33017JR	2CE	26.3	93.5	94	121.5	118	125	6	6.5	1.5	1.5	0.29	2.06	1.13	1.72	
140		41	41	32	2.5	2	282	346	52.2	2 600	3 500	33117JR	3DE	33.2	97	95	130	122	135	7	9	2	2	0.41	1.48	0.81	2.43	
150		30.5	28	24	2.5	2	228	231	35.1	2 500	3 400	30217JR	3EB	30.4	97	97	140	132	141	5	6.5	2	2	0.42	1.43	0.79	2.17	
150		38.5	36	30	2.5	2	290	315	47.5	2 500	3 400	32217JR	3EC	34.2	97	96	140	130	142	5	8.5	2	2	0.42	1.43	0.79	2.80	
150		49	49	37	2.5	2	368	439	59.1	2 500	3 400	33217JR	3EE	37.1	97	95	140	128	144	7	12	2	2	0.42	1.43	0.79	3.63	
180		44.5	41	28	4	3	288	265	36.0	1 900	2 600	30317D	—	56.0	103	103	166	143	169	6	16.5	3	2.5	0.81	0.74	0.41	4.54	
180		44.5	41	28	4	3	328	317	42.6	1 900	2 600	30317DJR	7GB	56.3	103	103	166	143	169	6	16.5	3	2.5	0.83	0.73	0.40	4.81	
180		44.5	41	34	4	3	396	384	53.0	2 200	2 900	30317JR	2GB	36.0	103	107	166	156	167	5	10.5	3	2.5	0.35	1.74	0.96	5.15	
180		44.5	41	34	4	3	381	367	51.1	2 200	2 900	30317R	—	35.8	103	107	166	156	167	5	10.5	3	2.5	0.35	1.73	0.95	4.97	
180		63.5	60	49	4	3	549	587	77.6	2 200	3 000	32317JR	2GD	43.8	103	103	166	150	167	5	14.5	3	2.5	0.35	1.74	0.96	7.42	
90		125	23	23	18	1.5	1.5	126	175	26.2	2 800	3 700	32918JR	2BC	22.3	98.5	97	116.5	114	120	5	5	1.5	1.5	0.34	1.75	0.96	0.834
		140	32	32	24	2	1.5	224	276	41.5	2 600	3 500	32018JR	3CC	29.8	100	100	131.5	125	134	6	8	2	1.5	0.42	1.42	0.78	1.80
	140	39	39	32.5	2	1.5	278	367	55.6	2 600	3 400	33018JR	2CE	27.1	100	100	131.5	127	135	7	6.5	2	1.5	0.27	2.23	1.23	2.22	
	150	45	45	35	2.5	2	324	413	61.1	2 500	3 300	33118JR	3DE	35.4	102	100	140	130	144	7	10	2	2	0.40	1.51	0.83	3.13	
	155	46	46	38	3	3	342	405	54.1	2 400	3 200	T2ED090	2ED	33.5	104	102	141	135	147	7	8	2.5	2.5	0.33	1.84	1.01	3.47	
	160	32.5	30	26	2.5	2	255	261	39.0	2 400	3 200	30218JR	3FB	32.6	102	103	150	140	150	5	6.5	2	2	0.42	1.43	0.79	2.65	
	160	42.5	40	34	2.5	2	329	362	53.7	2 400	3 200	32218JR	3FC	37.0	102	102	150	138	152	5	8.5	2	2	0.42	1.43	0.79	3.47	

Single-row tapered roller bearings  
metric series

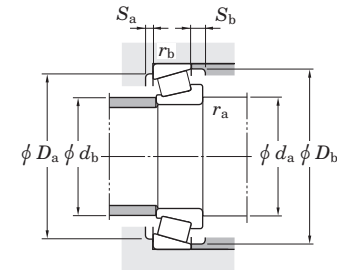
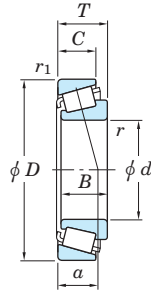
$d$  (90) ~ (100) mm



Boundary dimensions (mm)							Basic load ratings (kN)		Fatigue load limit (kN) $C_u$	Limiting speeds ( $\text{min}^{-1}$ )		Bearing No.	Dimension series to ISO355 (Refer.)	Load center (mm) $a$	Mounting dimensions (mm)								Constant $e$	Axial load factors		(Refer.) Mass (kg)	
$d$	$D$	$T$	$B$	$C$	$r_{\text{min}}$	$r_{1\text{min}}$	$C_r$	$C_{0r}$		Grease lub.	Oil lub.				$d_a$ min.	$d_b$ max.	$D_a$ max.	$D_b$ min.	$S_a$ min.	$S_b$ min.	$r_a$ max.	$r_b$ max.		$Y_1$	$Y_0$		
90	160	55	55	42	2.5	2	430	527	68.3	2 400	3 200	33218JR	3FE	40.8	102	101	150	135	154	9	13	2	2	0.42	1.43	0.78	4.76
	190	46.5	43	30	4	3	359	350	46.2	1 700	2 400	30318DJR	7GB	59.6	108	109	176	151	179	6	16.5	3	2.5	0.83	0.73	0.40	5.57
	190	46.5	43	30	4	3	352	336	44.9	1 700	2 400	30318DR	—	59.1	108	109	176	151	179	6	16.5	3	2.5	0.81	0.74	0.41	5.60
	190	46.5	43	36	4	3	432	420	57.1	2 100	2 700	30318JR	2GB	38.1	108	113	176	165	177	5	10.5	3	2.5	0.35	1.74	0.96	6.04
	190	46.5	43	36	4	3	421	407	55.5	2 100	2 700	30318R	—	37.2	108	113	176	165	177	5	10.5	3	2.5	0.35	1.73	0.95	5.78
	190	67.5	64	53	4	3	577	614	78.7	2 100	2 800	32318JR	2GD	46.6	108	108	176	157	177	5	14.5	3	2.5	0.35	1.74	0.96	8.61
95	130	23	23	18	1.5	1.5	130	186	27.4	2 600	3 500	32919JR	2BC	23.5	103.5	102	121.5	119	125	5	5	1.5	1.5	0.36	1.68	0.92	0.876
	145	32	32	24	2	1.5	229	287	42.6	2 500	3 300	32019JR	4CC	31.2	105	105	136.5	130	140	6	8	2	1.5	0.44	1.36	0.75	1.88
	145	39	39	32.5	2	1.5	284	382	57.3	2 500	3 300	33019JR	2CE	27.8	105	104	136.5	131	139	7	6.5	2	1.5	0.28	2.16	1.19	2.31
	160	46	46	38	3	3	353	427	56.4	2 300	3 100	T2ED095	2ED	34.6	109	107	146	140	152	7	8	2.5	2.5	0.34	1.77	0.97	3.62
	160	49	49	38	2.5	2	381	473	62.5	2 300	3 100	33119JR	3EE	37.3	107	106	150	138	154	8	11	2	2	0.39	1.54	0.85	3.89
	170	34.5	32	27	3	2.5	289	299	44.0	2 200	3 000	30219JR	3FB	34.9	109	110	158	149	159	5	7.5	2.5	2	0.42	1.43	0.79	3.20
	170	45.5	43	37	3	2.5	389	439	64.1	2 200	3 000	32219JR	3FC	38.9	109	108	158	145	161	5	8.5	2.5	2	0.42	1.43	0.79	4.34
	170	58	58	44	3	2.5	468	582	74.0	2 200	2 900	33219JR	3FE	42.8	109	107	158	144	163	9	14	2.5	2	0.41	1.47	0.81	5.66
	200	49.5	45	32	4	3	398	391	50.4	1 700	2 300	30319DJR	7GB	62.7	113	113	186	157	187	6	17.5	3	2.5	0.83	0.73	0.40	6.68
	200	49.5	45	38	4	3	396	368	49.2	2 000	2 600	30319	—	39.8	113	118	186	172	186	5	11.5	3	2.5	0.35	1.73	0.95	6.32
	200	49.5	45	38	4	3	465	455	60.9	2 000	2 600	30319JR	2GB	40.8	113	118	186	172	186	5	11.5	3	2.5	0.35	1.74	0.96	6.96
	200	71.5	67	55	4	3	534	544	70.2	2 000	2 600	32319	—	49.1	113	115	186	166	186	5	16.5	3	2.5	0.35	1.73	0.95	9.35
	200	71.5	67	55	4	3	646	695	89.2	2 000	2 600	32319JR	2GD	49.8	113	115	186	166	186	5	16.5	3	2.5	0.35	1.74	0.96	10.1
	100	140	25	25	20	1.5	1.5	158	217	32.0	2 400	3 300	32920JR	2CC	24.0	109	108	131	128	135	5	5	1.5	1.5	0.33	1.82	1.00
145		24	22.5	17.5	3	3	146	167	24.6	2 400	3 200	T4CB100	4CB	29.9	112	109	133	132	140	4	6.5	2.5	2.5	0.47	1.27	0.70	1.12
150		32	32	24	2	1.5	233	298	43.8	2 400	3 200	32020JR	4CC	32.6	110	109	141	134	144	6	8	2	1.5	0.46	1.31	0.72	1.95
150		39	39	32.5	2	1.5	290	397	59.0	2 400	3 200	33020JR	2CE	28.6	110	108	141	135	143	7	6.5	2	1.5	0.29	2.09	1.15	2.40
165		47	46	39	3	3	368	458	59.5	2 200	3 000	T2EE100	2EE	35.1	114	112	151	145	157	7	8	2.5	2.5	0.32	1.88	1.04	3.86
165		52	52	40	2.5	2	408	523	67.4	2 200	3 000	33120JR	3EE	40.1	112	111	155	142	159	8	12	2	2	0.41	1.48	0.81	4.29
180		37	34	29	3	2.5	323	338	49.1	2 100	2 800	30220JR	3FB	36.8	114	116	168	157	168	5	8	2.5	2	0.42	1.43	0.79	3.83
180		49	46	39	3	2.5	435	495	63.9	2 100	2 800	32220JR	3FC	42.1	114	114	168	154	171	5	10	2.5	2	0.42	1.43	0.79	5.21
180		63	63	48	3	2.5	540	680	85.8	2 100	2 800	33220JR	3FE	45.7	114	112	168	151	172	10	15	2.5	2	0.40	1.48	0.82	6.92

Single-row tapered roller bearings  
metric series

*d* (100) ~ (110) mm



Boundary dimensions (mm)						Basic load ratings (kN)		Fatigue load limit (kN) <i>C<sub>u</sub></i>	Limiting speeds (min <sup>-1</sup> )		Bearing No.	Dimension series to ISO355 (Refer.)	Load center (mm) <i>a</i>	Mounting dimensions (mm)								Constant <i>e</i>	Axial load factors		(Refer.) Mass (kg)	
<i>d</i>	<i>D</i>	<i>T</i>	<i>B</i>	<i>C</i>	<i>r</i> <sub>min.</sub>	<i>r</i> <sub>1 min.</sub>	<i>C<sub>r</sub></i>		<i>C<sub>0r</sub></i>	Grease lub.				Oil lub.	<i>d<sub>a</sub></i> min.	<i>d<sub>b</sub></i> max.	<i>D<sub>a</sub></i> max.	<i>D<sub>b</sub></i> min.	<i>S<sub>a</sub></i> min.	<i>S<sub>b</sub></i> min.	<i>r<sub>a</sub></i> max.		<i>r<sub>b</sub></i> max.	<i>Y</i> <sub>1</sub>		<i>Y</i> <sub>0</sub>
100	215	51.5	47	34	4	3	397	374	48.5	1 500	2 100	—	65.9	118	121	201	183	204	5	17	3	2.5	0.81	0.74	0.41	8.02
	215	51.5	47	39	4	3	430	400	52.5	1 800	2 400	—	41.4	118	127	201	184	200	6	12.5	3	2.5	0.35	1.73	0.95	7.76
	215	51.5	47	39	4	3	528	521	68.0	1 800	2 400	2GB	42.7	118	127	201	184	200	6	12.5	3	2.5	0.35	1.74	0.96	8.49
	215	56.5	51	35	4	3	465	459	56.4	1 500	2 200	7GB	67.7	118	120	201	183	202	6	17.5	3	2.5	0.83	0.73	0.40	8.72
	215	77.5	73	60	4	3	614	637	79.6	1 800	2 400	—	52.6	118	123	201	177	200	8	17.5	3	2.5	0.35	1.73	0.95	12.2
	215	77.5	73	60	4	3	725	783	96.9	1 800	2 400	2GD	53.9	118	123	201	177	200	8	17.5	3	2.5	0.35	1.74	0.96	13.0
105	145	25	25	20	1.5	1.5	160	224	32.6	2 400	3 100	2CC	25.1	113.5	113	136.5	133	140	5	5	1.5	1.5	0.34	1.75	0.96	1.23
	160	35	35	26	2.5	2	270	344	49.9	2 200	3 000	4DC	34.5	117	116	150	143	154	6	9	2	2	0.44	1.35	0.74	2.45
	160	43	43	34	2.5	2	335	461	67.4	2 200	3 000	2DE	30.9	117	116	150	145	153	7	9	2	2	0.28	2.12	1.17	3.08
	175	56	56	44	2.5	2	453	607	76.0	2 100	2 800	3EE	43.2	117	116	165	150	169	9	12	2	2	0.40	1.48	0.82	5.33
	190	39	36	30	3	2.5	360	380	52.3	2 000	2 600	3FB	39.0	119	122	178	165	178	6	9	2.5	2	0.42	1.43	0.79	4.49
	190	53	50	43	3	2.5	490	567	73.0	2 000	2 700	3FC	44.8	119	120	178	161	180	6	10	2.5	2	0.42	1.43	0.79	6.37
	190	68	68	52	3	2.5	622	790	97.4	2 000	2 600	3FE	48.8	119	117	178	159	182	10	16	2.5	2	0.40	1.49	0.82	8.43
	225	53.5	49	36	4	3	423	396	50.1	1 400	2 000	—	69.1	123	127	211	193	209	6	17	3	2.5	0.81	0.74	0.41	8.76
	225	53.5	49	41	4	3	464	432	56.0	1 700	2 300	—	43.1	123	132	211	193	209	7	12.5	3	2.5	0.35	1.73	0.95	8.74
	225	53.5	49	41	4	3	581	578	73.6	1 700	2 300	2GB	44.1	123	132	211	193	209	7	12.5	3	2.5	0.35	1.74	0.96	9.73
	225	58	53	36	4	3	495	489	59.4	1 500	2 100	7GB	70.3	123	126	211	193	211	6	18	3	2.5	0.83	0.73	0.40	9.72
	225	81.5	77	63	4	3	679	707	86.7	1 800	2 300	—	55.7	123	128	211	185	209	8	18.5	3	2.5	0.35	1.73	0.95	13.9
	225	81.5	77	63	4	3	794	866	107	1 800	2 300	2GD	56.1	123	128	211	185	209	8	18.5	3	2.5	0.35	1.74	0.96	14.9
	110	150	25	25	20	1.5	1.5	162	231	33.3	2 300	3 000	2CC	26.3	119	118	141	138	145	5	5	1.5	1.5	0.36	1.69	0.93
160		27	25.5	19.5	3	3	183	225	32.3	2 200	2 900	4CB	31.8	124	120	146	145	154	5	7.5	2.5	2.5	0.44	1.36	0.75	1.63
170		38	38	29	2.5	2	312	395	56.7	2 100	2 800	4DC	36.1	122	122	160	152	163	7	9	2	2	0.43	1.39	0.77	3.12
170		47	47	37	2.5	2	360	502	64.9	2 100	2 800	2DE	33.4	122	123	160	152	161	7	10	2	2	0.29	2.09	1.15	3.81
180		56	56	43	2.5	2	464	634	78.6	2 000	2 700	3EE	44.5	122	121	170	155	174	9	13	2	2	0.42	1.43	0.79	5.52
200		41	38	32	3	2.5	405	434	58.1	1 900	2 500	3FB	40.8	124	129	188	174	188	6	9	2.5	2	0.42	1.43	0.79	5.33
200		56	53	46	3	2.5	547	640	80.4	1 900	2 500	3FC	46.7	124	126	188	170	190	6	10	2.5	2	0.42	1.43	0.79	7.45
240		54.5	50	36	4	3	456	429	53.5	1 400	1 900	—	71.5	128	135	226	205	222	6	18	3	2.5	0.81	0.74	0.41	10.2
240		54.5	50	42	4	3	509	475	60.5	1 600	2 100	—	44.8	128	141	226	206	222	8	12.5	3	2.5	0.35	1.73	0.95	10.4

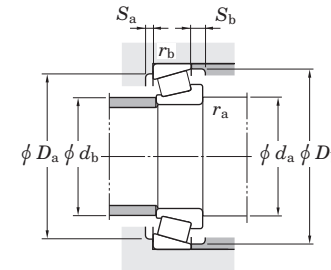
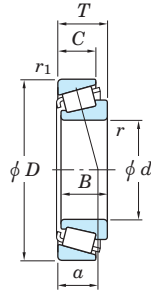






Single-row tapered roller bearings  
metric series

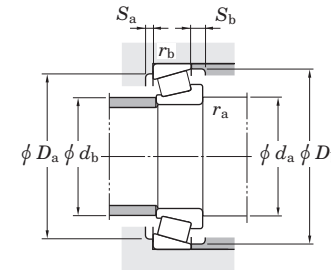
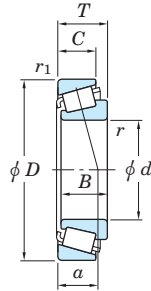
$d$  (170) ~ 200 mm



Boundary dimensions (mm)							Basic load ratings (kN)		Fatigue load limit (kN) $C_u$	Limiting speeds ( $\text{min}^{-1}$ )		Bearing No.	Dimension series to ISO355 (Refer.)	Load center (mm) $a$	Mounting dimensions (mm)								Constant $e$	Axial load factors		(Refer.) Mass (kg)	
$d$	$D$	$T$	$B$	$C$	$r_{\text{min}}$	$r_{1\text{min}}$	$C_r$	$C_{0r}$		Grease lub.	Oil lub.				$d_a$ min.	$d_b$ max.	$D_a$ max.	$D_b$ min.	$S_a$ min.	$S_b$ min.	$r_a$ max.	$r_b$ max.		$Y_1$	$Y_0$		
170	260	57	57	43	3	2.5	661	905	105	1 300	1 700	32034JR	4EC	55.8	184	187	248	230	249	10	14	2.5	2	0.44	1.35	0.74	10.5
	310	57	52	43	5	4	776	867	103	1 100	1 500	30234JR	4GB	61.2	192	202	292	269	288	8	14	4	3	0.44	1.38	0.76	17.8
	310	91	86	71	5	4	1 120	1 380	152	1 100	1 500	32234JR	4GD	76.2	192	195	292	259	294	10	20	4	3	0.44	1.38	0.76	28.9
	360	80	72	50	5	4	953	1 040	115	830	1 200	30334D	—	108.3	192	211	342	310	333	9	30	4	3	0.81	0.74	0.41	34.3
	360	80	72	62	5	4	1 300	1 370	155	1 000	1 300	30334JR	2GB	67.9	192	218	342	306	329	13	18	4	3	0.35	1.74	0.96	37.5
	360	127	120	100	5	4	1 640	1 830	193	1 000	1 300	32334	—	86.1	192	200	342	295	337	14	26	4	3	0.35	1.73	0.95	56.9
180	250	45	45	34	2.5	2	447	735	93.4	1 300	1 700	32936JR	4DC	53.5	192	193	240	225	241	8	11	2	2	0.48	1.25	0.69	6.64
	280	64	64	48	3	2.5	810	1 100	127	1 200	1 600	32036JR	3FD	59.5	194	199	268	247	268	10	16	2.5	2	0.42	1.42	0.78	14.1
	320	57	52	43	5	4	771	870	102	1 100	1 400	30236JR	4GB	63.6	202	211	302	278	297	9	14	4	3	0.45	1.33	0.73	18.3
	320	91	86	71	5	4	1 200	1 520	164	1 100	1 500	32236JR	4GD	77.8	202	204	302	267	303	10	20	4	3	0.45	1.33	0.73	29.9
	380	83	75	52	5	4	1 040	1 150	125	780	1 100	30336D	—	112.8	202	225	362	330	351	10	31	4	3	0.81	0.74	0.41	40.1
	380	83	75	64	5	4	1 130	1 110	126	940	1 300	30336	—	71.0	202	227	362	318	346	13	19	4	3	0.35	1.73	0.95	39.7
	380	134	126	106	5	4	1 760	1 980	206	960	1 300	32336	—	91.8	202	215	362	310	355	14	27	4	3	0.35	1.73	0.95	67.0
190	260	45	45	34	2.5	2	459	789	88.6	1 200	1 600	32938JR	4DC	55.0	202	204	250	235	252	8	11	2	2	0.48	1.26	0.69	6.89
	290	64	64	48	3	2.5	823	1 170	131	1 100	1 500	32038JR	4FD	62.9	204	209	278	257	279	10	16	2.5	2	0.44	1.36	0.75	14.7
	340	60	55	46	5	4	912	1 030	118	1 000	1 300	30238JR	4GB	66.4	212	225	322	298	318	12	13	4	3	0.44	1.38	0.76	21.9
	340	97	92	75	5	4	1 370	1 740	187	1 000	1 300	32238JR	4GD	81.9	212	216	322	286	323	12	22	4	3	0.44	1.38	0.76	36.6
	400	86	78	52	6	5	1 190	1 210	131	740	1 000	30338D	—	119.2	218	232	378	350	372	11	34	5	4	0.81	0.74	0.41	44.8
	400	86	78	65	6	5	1 260	1 250	139	880	1 200	30338	—	73.2	218	241	378	342	370	10	20	5	4	0.35	1.73	0.95	46.2
	400	140	132	109	6	5	1 940	2 190	224	890	1 200	32338	—	96.5	218	225	378	330	375	14	30	5	4	0.35	1.73	0.95	76.6
200	280	51	51	39	3	2.5	608	958	109	1 100	1 500	32940JR	3EC	53.6	214	216	268	257	271	9	12	2.5	2	0.39	1.52	0.84	9.44
	310	70	70	53	3	2.5	949	1 340	146	1 100	1 400	32040JR	4FD	66.9	214	221	298	273	297	11	17	2.5	2	0.43	1.39	0.77	19.1
	360	64	58	48	5	4	991	1 120	126	940	1 200	30240JR	4GB	70.3	222	238	342	315	336	12	15	4	3	0.44	1.38	0.76	26.4
	360	104	98	82	5	4	1 550	1 880	200	960	1 300	32240JR	3GD	84.6	222	225	342	302	340	11	22	4	3	0.41	1.48	0.81	44.2
	420	89	80	56	6	5	1 130	1 230	132	690	970	30340D	—	122.6	228	248	398	365	385	11	33	5	4	0.81	0.74	0.41	50.6
	420	89	80	67	6	5	1 400	1 450	159	820	1 100	30340	—	79.8	228	255	398	354	385	11	21	5	4	0.35	1.73	0.95	53.5
	420	146	138	115	6	5	2 240	2 580	260	830	1 100	32340	—	102.9	228	240	398	345	395	16	30	5	4	0.35	1.73	0.95	91.0

Single-row tapered roller bearings  
metric series

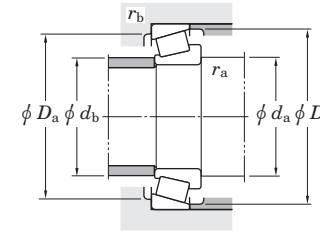
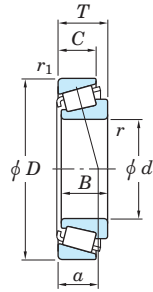
d 220 ~ 360 mm



Boundary dimensions (mm)							Basic load ratings (kN)		Fatigue load limit (kN) C <sub>u</sub>	Limiting speeds (min <sup>-1</sup> )		Bearing No.	Dimension series to ISO355 (Refer.)	Load center (mm) a	Mounting dimensions (mm)								Constant e	Axial load factors		(Refer.) Mass (kg)		
d	D	T	B	C	r <sub>min.</sub>	r <sub>1 min.</sub>	C <sub>r</sub>	C <sub>0r</sub>		Grease lub.	Oil lub.				d <sub>a min.</sub>	d <sub>b max.</sub>	D <sub>a max.</sub>	D <sub>b min.</sub>	S <sub>a min.</sub>	S <sub>b min.</sub>	r <sub>a max.</sub>	r <sub>b max.</sub>		Y <sub>1</sub>	Y <sub>0</sub>			
<b>220</b>	300	51	51	39	3	2.5	621	1 010	112	1 000	1 400	<b>32944JR</b> <b>32044JR</b> <b>30244JR</b>	3EC 4FD —	58.6	234	234	288	275	290	9	12	2.5	2	0.43	1.41	0.78	10.1	
	340	76	76	57	4	3	1 120	1 620	175	940	1 300			72.8	238	243	326	300	326	12	19	3	2.5	0.43	1.39	0.77	25.2	
	400	72	65	54	5	4	1 260	1 440	160	830	1 100			—	76.5	242	263	382	344	371	14	17	4	3	0.44	1.43	0.79	35.9
	400	114	108	90	5	4	1 500	1 930	198	830	1 100	<b>32244</b> <b>30344</b>	— —	95.9	242	260	382	333	377	16	14	4	3	0.43	1.39	0.77	56.8	
	460	97	88	73	6	5	1 570	1 680	181	730	980			84.6	248	282	438	386	420	12	23	5	4	0.35	1.73	0.95	69.0	
<b>240</b>	320	51	51	39	3	2.5	645	1 090	119	940	1 300	<b>32948JR</b> <b>32048JR</b> <b>30248R</b> <b>32248</b>	4EC 4FD — —	64.5	254	254	308	294	311	9	12	2.5	2	0.46	1.31	0.72	10.9	
	360	76	76	57	4	3	1 160	1 720	180	870	1 200			78.5	258	261	346	318	346	12	19	3	2.5	0.46	1.31	0.72	26.8	
	440	79	72	60	5	4	1 540	1 790	191	730	980			—	82.7	262	287	422	377	409	14	18	4	3	0.42	1.43	0.79	49.5
	440	127	120	100	5	4	1 920	2 480	245	740	980			106.1	262	282	422	365	415	16	14	4	3	0.43	1.39	0.77	76.4	
<b>260</b>	360	63.5	63.5	48	3	2.5	926	1 550	163	830	1 100	<b>32952JR</b> <b>32052JR</b> <b>30252</b> <b>32252</b>	3EC 4FC — —	69.6	274	279	348	328	347	11	15.5	2.5	2	0.41	1.48	0.81	18.9	
	400	87	87	65	5	4	1 470	2 170	221	770	1 000			85.0	282	287	382	352	383	14	22	4	3	0.43	1.38	0.76	39.5	
	480	89	80	67	6	5	1 510	1 860	190	650	870			—	93.6	288	310	458	415	450	14	21	5	4	0.42	1.44	0.79	64.9
	480	137	130	106	6	5	2 200	2 870	276	660	880			115.2	288	300	458	400	455	16	30	5	4	0.43	1.39	0.77	102	
<b>280</b>	380	63.5	63.5	48	3	2.5	949	1 630	168	770	1 000	<b>32956JR</b> <b>32056JR</b> <b>30256</b> <b>32256</b>	4EC 4FC — —	75.1	294	298	368	347	368	11	15.5	2.5	2	0.43	1.39	0.76	20.1	
	420	87	87	65	5	4	1 510	2 280	230	720	960			91.1	302	305	402	370	402	14	22	4	3	0.46	1.31	0.72	41.7	
	500	89	80	67	6	5	1 580	1 920	196	610	810			—	96.2	308	325	478	440	475	14	21	5	4	0.42	1.44	0.79	67.6
	500	137	130	106	6	5	2 340	3 150	297	610	810			117.2	308	325	478	420	474	16	30	5	4	0.43	1.39	0.77	108	
<b>300</b>	420	76	76	57	4	3	1 320	2 210	223	680	910	<b>32960JR</b> <b>32060JR</b> <b>30260</b>	3FD 4GD —	79.9	318	324	406	383	405	12	19	3	2.5	0.39	1.52	0.84	32.4	
	460	100	100	74	5	4	1 800	2 660	263	640	850			97.9	322	329	442	404	439	15	26	4	3	0.43	1.38	0.76	57.5	
	540	96	85	71	6	5	1 890	2 360	240	550	730			—	103.9	328	350	518	475	505	14	24	5	4	0.42	1.44	0.79	84.7
<b>320</b>	440	76	76	57	4	3	1 330	2 270	226	640	850	<b>32964JR</b> <b>32064JR</b> <b>30264</b>	3FD 4GD —	85.0	338	342	426	401	426	12	19	3	2.5	0.42	1.44	0.79	34.0	
	480	100	100	74	5	4	1 900	2 810	273	600	800			103.0	342	344	462	418	461	16	26	4	3	0.46	1.31	0.72	58.7	
	580	104	92	75	6	5	2 190	2 770	273	490	660			—	111.9	348	370	558	505	540	14	28	5	4	0.42	1.44	0.79	108
<b>340</b>	460	76	76	57	4	3	1 340	2 340	229	590	790	<b>32968JR</b>	4FD	90.5	358	361	446	420	446	12	19	3	2.5	0.44	1.37	0.75	35.6	
<b>360</b>	480	76	76	57	4	3	1 350	2 400	231	560	740	<b>32972JR</b>	4FD	96.2	378	379	466	438	466	12	19	3	2.5	0.46	1.31	0.72	37.1	

Single-row tapered roller bearings  
inch series

$d$  9.525 ~ (22.225) mm

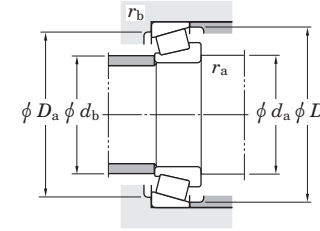
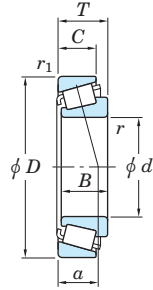


Boundary dimensions (mm)							Basic load ratings (kN)		Fatigue load limit (kN)	Limiting speeds (min <sup>-1</sup> )		Inner ring	Outer ring	Load center (mm)	Mounting dimensions (mm)						Constant $e$	Axial load factors		(Refer.) Mass (kg)	
$d$	$D$	$T$	$B$	$C$	$r_{min.}$	$r_{1 min.}$	$C_r$	$C_{0r}$	$C_u$	Grease lub.	Oil lub.				$a$	$d_a$	$d_b$	$D_a$	$D_b$	$r_{a max.}$		$r_{b max.}$	$e$	$Y_1$	$Y_0$
<b>9.525</b>	31.991	10.008	10.785	7.938	1.2	1.2	13.4	9.30	1.25	14 000	19 000	<b>A2037</b>	<b>A2126</b>	7.1	15.0	13.5	26.0	29.0	1.2	1.2	0.40	1.48	0.82	0.029	0.017
<b>11.986</b>	31.991	10.008	10.785	7.938	0.8	1.2	13.4	9.30	1.25	14 000	19 000	<b>A2047</b>	<b>A2126</b>	7.1	16.5	15.5	26.0	29.0	0.8	1.2	0.40	1.48	0.82	0.023	0.017
<b>12.700</b>	34.988	10.998	10.988	8.730	1.2	1.2	15.7	11.9	1.55	12 000	17 000	<b>A4050</b>	<b>A4138</b>	8.3	18.5	17.0	29.0	32.0	1.2	1.2	0.45	1.33	0.73	0.033	0.022
<b>14.989</b>	34.988	10.998	10.988	8.730	0.8	1.2	15.7	11.9	1.55	12 000	17 000	<b>A4059</b>	<b>A4138</b>	8.3	19.5	19.0	29.0	32.0	0.8	1.2	0.45	1.33	0.73	0.029	0.022
<b>15.875</b>	34.988	10.998	10.998	8.712	1.2	1.2	18.1	14.3	1.90	12 000	16 000	<b>L21549</b>	<b>L21511</b>	7.6	21.5	19.5	29.0	32.5	1.2	1.2	0.32	1.88	1.04	0.031	0.018
	41.275	14.288	14.681	11.112	1.2	2.0	27.3	20.5	2.85	11 000	14 000	<b>03062</b>	<b>03162</b>	9.3	21.5	20.0	34.0	37.5	1.2	2.0	0.31	1.93	1.06	0.060	0.035
	42.862	16.670	16.670	13.495	1.6	1.6	38.2	29.5	4.15	10 000	14 000	<b>17580R</b>	<b>17520</b>	10.9	23.0	21.0	36.5	39.0	1.6	1.6	0.33	1.81	1.00	0.078	0.048
	49.225	19.845	21.539	14.288	0.8	1.2	47.2	37.7	5.40	8 900	12 000	<b>09062</b>	<b>09195</b>	10.6	22.0	21.5	42.0	44.5	0.8	1.2	0.27	2.26	1.24	0.139	0.065
	53.975	22.225	21.839	15.875	0.8	2.4	52.6	41.2	5.65	8 400	11 000	<b>21063</b>	<b>21212</b>	16.6	29.0	26.5	43.0	50.0	0.8	2.4	0.59	1.02	0.56	0.163	0.097
<b>16.000</b>	47.000	21.000	21.000	16.000	1.0	2.0	45.4	37.7	5.05	9 800	13 000	<b>HM81649</b>	<b>HM81610</b>	15.0	27.5	23.0	37.5	43.0	1.0	2.0	0.55	1.10	0.60	0.111	0.080
<b>17.462</b>	39.878	13.843	14.605	10.668	1.2	1.2	31.8	26.0	3.60	11 000	14 000	<b>LM11749R</b>	<b>LM11710</b>	8.6	23.0	21.5	34.0	37.0	1.2	1.2	0.29	2.10	1.15	0.058	0.028
<b>19.050</b>	45.237	15.494	16.637	12.065	1.2	1.2	36.8	30.1	4.25	9 400	13 000	<b>LM11949</b>	<b>LM11910</b>	10.0	25.0	23.5	39.5	41.5	1.2	1.2	0.30	2.00	1.10	0.081	0.044
	49.225	19.845	21.539	14.288	1.2	1.2	47.2	37.7	5.40	8 900	12 000	<b>09078</b>	<b>09195</b>	10.6	25.5	24.0	42.0	44.5	1.2	1.2	0.27	2.26	1.24	0.124	0.065
	49.225	21.209	19.050	17.462	1.2	1.6	47.2	37.7	5.40	8 900	12 000	<b>09067</b>	<b>09196</b>	13.8	25.5	24.0	41.5	44.5	1.2	1.6	0.27	2.26	1.24	0.114	0.084
<b>20.000</b>	50.005	13.495	14.260	9.525	1.6	1.0	33.3	28.8	4.05	7 900	11 000	<b>07079</b>	<b>07196</b>	10.8	27.5	26.0	44.5	47.0	1.6	1.0	0.40	1.49	0.82	0.104	0.034
<b>20.638</b>	49.225	19.845	19.845	15.875	1.6	1.6	45.5	37.7	5.35	8 600	12 000	<b>12580</b>	<b>12520</b>	12.7	28.5	26.0	42.5	45.5	1.6	1.6	0.32	1.86	1.02	0.116	0.067
<b>21.430</b>	50.005	17.526	18.288	13.970	1.2	1.2	48.8	40.7	5.80	8 500	11 000	<b>M12649</b>	<b>M12610</b>	11.1	27.5	25.5	44.0	46.0	1.2	1.2	0.28	2.16	1.19	0.119	0.058
<b>21.987</b>	45.974	15.494	16.637	12.065	1.2	1.2	37.5	34.6	4.85	8 900	12 000	<b>LM12749</b>	<b>LM12711</b>	10.0	27.5	26.0	40.0	42.5	1.2	1.2	0.31	1.96	1.08	0.078	0.043
<b>22.225</b>	50.005	17.526	18.288	13.970	1.2	1.2	48.8	40.7	5.80	8 500	11 000	<b>M12648</b>	<b>M12610</b>	11.1	28.5	26.5	44.0	46.0	1.2	1.2	0.28	2.16	1.19	0.115	0.058
	52.388	19.368	20.168	14.288	1.6	1.6	45.9	37.9	5.45	8 000	11 000	<b>1380</b>	<b>1328</b>	11.6	29.5	29.5	45.0	48.5	1.6	1.6	0.29	2.05	1.13	0.132	0.066
	53.975	19.368	20.168	14.288	1.6	1.6	45.9	37.9	5.45	8 000	11 000	<b>1380</b>	<b>1329</b>	11.6	29.5	29.5	46.0	49.0	1.6	1.6	0.29	2.05	1.13	0.137	0.082

[Remark] Inch series tapered roller bearings with bore diameter larger than 100 mm are shown in catalog "large size ball & roller bearings".

Single-row tapered roller bearings  
inch series

*d* (22.225) ~ (26.988) mm



Boundary dimensions (mm)							Basic load ratings (kN)		Fatigue load limit (kN)	Limiting speeds (min <sup>-1</sup> )		Bearing No.	Load center (mm)	Mounting dimensions (mm)						Constant <i>e</i>	Axial load factors		(Refer.) Mass (kg)			
<i>d</i>	<i>D</i>	<i>T</i>	<i>B</i>	<i>C</i>	<i>r</i> min.	<i>r</i> <sub>1</sub> min.	<i>C<sub>r</sub></i>	<i>C<sub>0r</sub></i>	<i>C<sub>u</sub></i>	Grease lub.	Oil lub.			Inner ring	Outer ring	<i>d<sub>a</sub></i>	<i>d<sub>b</sub></i>	<i>D<sub>a</sub></i>	<i>D<sub>b</sub></i>		<i>r<sub>a</sub></i> max.	<i>r<sub>b</sub></i> max.	<i>Y<sub>1</sub></i>	<i>Y<sub>0</sub></i>	Inner ring	Outer ring
<b>22.225</b>	56.896	19.368	19.837	15.875	1.2	1.2	50.0	43.1	6.20	7 600	10 000	<b>1755</b>	<b>1729</b>	12.5	29.0	27.5	49.0	51.0	1.2	1.2	0.31	1.95	1.07	0.150	0.100	
	57.150	22.225	22.225	17.462	0.8	1.6	65.8	55.7	8.05	7 600	10 000			15.3	29.5	29.0	49.0	52.0	0.8	1.6	0.35	1.73	0.95	0.189	0.105	
	66.421	23.812	25.433	19.050	1.6	1.2	83.8	75.2	11.2	6 500	8 700			13.9	31.5	29.0	58.0	60.0	1.6	1.2	0.25	2.36	1.30	0.295	0.163	
<b>22.606</b>	47.000	15.500	15.500	12.000	1.6	1.0	35.0	32.8	4.45	8 700	12 000	<b>LM72849</b>	<b>LM72810</b>	12.3	30.0	28.0	40.5	44.0	1.6	1.0	0.47	1.27	0.70	0.076	0.047	
<b>23.812</b>	50.292	14.224	14.732	10.668	1.6	1.2	39.1	37.0	5.15	7 800	10 000	<b>L44640R</b>	<b>L44610</b>	10.8	30.5	28.5	44.5	47.0	1.6	1.2	0.37	1.60	0.88	0.099	0.034	
	56.896	19.368	19.837	15.875	0.8	1.2	50.0	43.1	6.20	7 600	10 000			12.5	29.5	28.5	49.0	51.0	0.8	1.2	0.31	1.95	1.07	0.141	0.100	
<b>24.981</b>	50.005	13.495	14.260	9.525	1.6	1.0	33.3	28.8	4.05	7 900	11 000	<b>07098</b>	<b>07196</b>	10.8	31.0	29.0	44.5	47.0	1.6	1.0	0.40	1.49	0.82	0.084	0.034	
	62.000	16.002	16.566	14.288	1.6	1.6	47.4	40.6	5.80	6 700	8 900			12.7	33.0	30.5	54.0	57.0	1.6	1.6	0.38	1.57	0.86	0.162	0.090	
<b>25.000</b>	50.005	13.495	14.260	9.525	1.6	1.0	33.3	28.8	4.05	7 900	11 000	<b>07097</b>	<b>07196</b>	10.8	31.0	29.0	44.5	47.0	1.6	1.0	0.40	1.49	0.82	0.085	0.035	
<b>25.400</b>	50.005	13.495	14.260	9.525	1.0	1.0	33.3	28.8	4.05	7 900	11 000	<b>07100</b>	<b>07196</b>	10.8	30.5	29.5	44.5	47.0	1.0	1.0	0.40	1.49	0.82	0.084	0.035	
	50.005	13.495	14.260	9.525	1.6	1.0	33.3	28.8	4.05	7 900	11 000			10.8	31.5	29.5	44.5	47.0	1.6	1.0	0.40	1.49	0.82	0.082	0.035	
	50.292	14.224	14.732	10.668	1.2	1.2	39.1	37.0	5.15	7 800	10 000			10.8	31.5	29.5	44.5	47.0	1.2	1.2	0.37	1.60	0.88	0.092	0.039	
	51.994	15.011	14.260	12.700	1.0	1.2	33.3	28.8	4.05	7 900	11 000	<b>07100</b>	<b>07204</b>	12.3	30.5	29.5	45.0	48.0	1.0	1.2	0.40	1.49	0.82	0.075	0.065	
	58.738	19.050	19.355	15.080	1.2	1.2	60.8	57.1	8.25	7 000	9 300			13.1	32.5	30.5	52.0	54.0	1.2	1.2	0.33	1.82	1.00	0.179	0.088	
	59.530	23.368	23.114	18.288	0.8	1.6	63.0	57.1	7.95	7 200	9 600			18.2	36.0	32.5	49.5	56.0	0.8	1.6	0.55	1.10	0.60	0.194	0.128	
	61.912	19.050	20.638	14.288	0.8	2.0	55.7	50.7	7.30	6 400	8 600	<b>15101</b>	<b>15243</b>	13.2	32.5	31.5	55.0	58.0	0.8	2.0	0.35	1.71	0.94	0.215	0.080	
	62.000	19.050	20.638	14.288	3.6	1.2	55.7	50.7	7.30	6 400	8 600			13.2	38.0	31.5	55.0	58.0	3.6	1.2	0.35	1.71	0.94	0.215	0.081	
	63.500	19.050	20.638	14.288	0.8	1.2	55.7	50.7	7.30	6 400	8 600			13.2	32.5	31.5	55.0	59.0	0.8	1.2	0.35	1.71	0.94	0.215	0.097	
	64.292	21.432	21.432	16.670	1.6	1.6	69.1	70.7	9.90	6 400	8 500	<b>M86643R</b>	<b>M86610</b>	18.0	38.0	36.5	54.0	61.0	1.6	1.6	0.55	1.10	0.60	0.248	0.127	
	66.421	23.812	25.433	19.050	1.2	1.2	83.8	75.2	11.2	6 500	8 700			13.9	33.5	31.5	58.0	60.0	1.2	1.2	0.25	2.36	1.30	0.272	0.163	
	68.262	22.225	22.225	17.462	0.8	1.6	63.7	61.1	8.80	6 000	8 000			17.1	34.5	33.5	59.0	63.0	0.8	1.6	0.42	1.44	0.79	0.275	0.150	
	72.233	25.400	25.400	19.842	0.8	2.4	83.8	87.4	12.4	5 700	7 600	<b>HM88630</b>	<b>HM88610</b>	20.7	39.5	39.5	60.0	69.0	0.8	2.4	0.55	1.10	0.60	0.391	0.185	
	<b>26.162</b>	66.421	23.812	25.433	19.050	1.6	1.2	83.8	75.2	11.2	6 500	8 700	<b>2682</b>	<b>2631</b>	13.9	34.5	32.0	58.0	60.0	1.6	1.2	0.25	2.36	1.30	0.268	0.163
	<b>26.988</b>	50.292	14.224	14.732	10.668	3.6	1.2	39.1	37.0	5.15	7 800	10 000	<b>L44649R</b>	<b>L44610</b>	10.8	37.5	31.0	44.5	47.0	3.6	1.2	0.37	1.60	0.88	0.083	0.039

[Remark] Inch series tapered roller bearings with bore diameter larger than 100 mm are shown in catalog "large size ball & roller bearings".

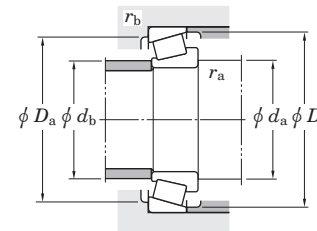
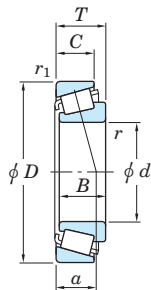






# Single-row tapered roller bearings inch series

$d$  (34.925) ~ (38.100) mm



Boundary dimensions (mm)							Basic load ratings (kN)		Fatigue load limit (kN)	Limiting speeds (min <sup>-1</sup> )		Bearing No. <sup>2)</sup>	Load center (mm)	Mounting dimensions (mm)						Constant	Axial load factors		(Refer.) Mass (kg)			
$d$	$D$	$T$	$B$	$C$	$r_1^{1)}$ min.	$r_1^{1)}$ min.	$C_r$	$C_{0r}$	$C_u$	Grease lub.	Oil lub.			Inner ring	Outer ring	$a$	$d_a$	$d_b$	$D_a$		$D_b$	$r_a$ max.	$r_b$ max.	$e$	$Y_1$	$Y_0$
34.925	72.238	20.638	20.638	15.875	3.6	1.2	62.3	61.3	8.90	5 600	7 400	16137	16284	16.6	46.5	40.5	63.0	67.0	3.6	1.2	0.40	1.49	0.82	0.236	0.144	
	73.025	22.225	22.225	17.462	3.6	3.2	68.8	65.7	9.55	5 500	7 400	02877	02820	18.4	48.5	42.0	62.0	68.0	3.6	3.2	0.45	1.32	0.73	0.262	0.158	
	73.025	22.225	22.225	17.462	0.8	3.2	68.8	65.7	9.55	5 500	7 400	02878	02820	18.4	42.5	42.0	62.0	68.0	0.8	3.2	0.45	1.32	0.73	0.265	0.158	
	73.025	23.812	24.608	19.050	1.6	0.8	90.1	87.3	13.1	5 600	7 400	25877R	25821	15.8	43.0	40.5	65.0	68.0	1.6	0.8	0.29	2.07	1.14	0.310	0.165	
	73.025	26.988	26.975	22.225	3.6	1.6	97.2	94.1	13.9	5 700	7 600	23690	23620	18.8	49.0	42.0	64.0	68.0	3.6	1.6	0.37	1.62	0.89	0.326	0.212	
	76.200	20.638	20.940	15.507	1.6	1.2	71.6	65.9	9.70	5 300	7 000	28137	28300	16.5	43.5	41.0	68.0	71.0	1.6	1.2	0.40	1.49	0.82	0.315	0.137	
	76.200	23.812	25.654	19.050	3.6	3.2	92.6	92.2	13.8	5 400	7 200	2796R	2720	15.9	47.5	41.0	66.0	70.0	3.6	3.2	0.30	1.98	1.09	0.344	0.185	
	76.200	29.370	28.575	23.812	1.6	3.2	101	97.4	14.4	5 400	7 200	31594	31520	21.6	46.0	43.5	64.0	72.0	1.6	3.2	0.40	1.49	0.82	0.388	0.232	
	79.375	29.370	29.771	23.812	3.6	3.2	109	105	15.7	5 200	6 900	3478	3420	20.8	50.0	43.5	67.0	74.0	3.6	3.2	0.37	1.64	0.90	0.462	0.256	
	87.312	30.162	30.886	23.812	3.6	3.2	120	120	18.2	4 600	6 200	3581R	3525	20.5	48.0	45.5	75.0	81.0	3.6	3.2	0.31	1.96	1.08	0.622	0.300	
	95.250	27.783	29.901	22.225	0.8	2.4	129	122	18.8	4 500	5 900	449	432	18.4	44.0	43.5	83.0	87.0	0.8	2.4	0.28	2.11	1.16	0.686	0.384	
	34.980	59.131	15.875	16.764	11.938	SP	1.2	44.9	48.5	6.85	6 400	8 500	L68149	L68110	13.2	45.5	39.0	53.0	56.0	3.5	1.2	0.42	1.44	0.79	0.112	0.056
		59.975	15.875	16.764	11.938	SP	1.2	44.9	48.5	6.85	6 400	8 500	L68149	L68111	13.2	45.5	39.0	53.0	56.0	3.5	1.2	0.42	1.44	0.79	0.112	0.063
35.000	79.375	23.812	25.400	19.050	0.8	0.8	101	105	15.8	5 000	6 700	26883R	26822	16.4	42.5	42.0	71.0	74.0	0.8	0.8	0.32	1.88	1.04	0.414	0.186	
	80.000	21.000	22.403	17.826	0.8	1.2	85.0	74.8	11.4	4 900	6 600	339	332	15.1	42.5	41.5	73.0	75.0	0.8	1.2	0.27	2.20	1.21	0.385	0.144	
35.717	72.233	25.400	25.400	19.842	3.6	2.4	83.8	87.4	12.4	5 700	7 600	HM88648	HM88610	20.7	52.0	42.5	60.0	69.0	3.6	2.4	0.55	1.10	0.60	0.291	0.185	
36.487	73.025	23.812	24.608	19.050	1.6	0.8	90.1	87.3	13.1	5 600	7 400	25880R	25821	15.8	44.0	42.0	65.0	68.0	1.6	0.8	0.29	2.07	1.14	0.294	0.165	
	73.025	23.812	25.654	19.050	3.6	0.8	92.6	92.2	13.8	5 400	7 200	2794R	2735X	15.9	49.0	42.5	66.0	69.0	3.6	0.8	0.30	1.98	1.09	0.344	0.134	
36.512	76.200	29.370	28.575	23.020	3.6	0.8	99.5	107	15.2	5 400	7 200	HM89449	HM89411	23.9	54.0	44.5	65.0	73.0	3.6	0.8	0.55	1.10	0.60	0.386	0.258	
	79.375	23.812	25.400	19.050	0.8	0.8	101	105	15.8	5 000	6 700	26877R	26822	16.4	44.0	43.0	71.0	74.0	0.8	0.8	0.32	1.88	1.04	0.404	0.186	
	79.375	29.370	29.771	23.812	0.8	3.2	109	105	15.7	5 200	6 900	3479	3420	20.8	45.5	44.5	67.0	74.0	0.8	3.2	0.37	1.64	0.90	0.429	0.259	
	85.725	30.162	30.162	23.812	0.8	3.2	135	136	20.3	4 800	6 400	3878	3820	22.9	48.0	47.0	73.0	81.0	0.8	3.2	0.40	1.49	0.82	0.605	0.285	
38.000	63.000	17.000	17.000	13.500	SP	SP	54.7	58.2	8.25	6 000	8 000	JL69349	JL69310	14.6	49.0	41.0	60.0	56.5	3.5	1.2	0.42	1.44	0.79	0.128	0.070	
38.100	63.500	12.700	11.908	9.525	1.6	0.8	32.1	33.1	4.60	5 800	7 700	13889	13830	11.9	45.0	42.5	59.0	60.0	1.6	0.8	0.35	1.73	0.95	0.104	0.045	

[Notes] 1) SP indicates the specially chamfered from.  
2) To the bearings with supplementary code "J" attached at the front of bearing number, tolerances shown in table 7-8 on page A72 are applied.

[Remark] Inch series tapered roller bearings with bore diameter larger than 100 mm are shown in catalog "large size ball & roller bearings".











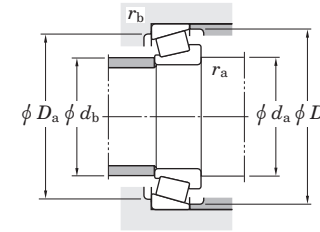
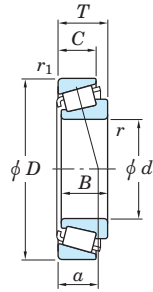






Single-row tapered roller bearings  
inch series

$d$  (60.000) ~ (65.000) mm



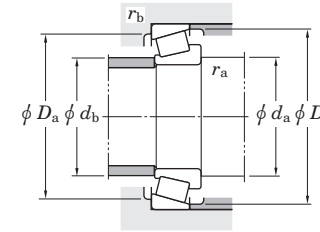
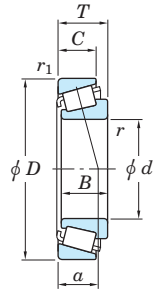
Boundary dimensions (mm)							Basic load ratings (kN)		Fatigue load limit (kN)	Limiting speeds (min <sup>-1</sup> )		Load center (mm)	Mounting dimensions (mm)						Constant $e$	Axial load factors		(Refer.) Mass (kg)			
$d$	$D$	$T$	$B$	$C$	$r_{min.}$	$r_{1 min.}$	$C_r$	$C_{0r}$	$C_u$	Grease lub.	Oil lub.		$a$	$d_a$	$d_b$	$D_a$	$D_b$	$r_{a max.}$		$r_{b max.}$	$e$	$Y_1$	$Y_0$	Inner ring	Outer ring
<b>60.000</b>	107.950	25.400	25.400	19.050	3.6	3.2	116	143	21.6	3 400	4 500	24.7	74.0	68.0	96.0	103.0	3.6	3.2	0.46	1.31	0.72	0.713	0.277		
	110.000	22.000	21.996	18.824	0.8	1.2	109	116	17.7	3 400	4 500		21.3	69.0	68.0	101.0	104.5	0.8		1.2	0.40	1.49	0.82	0.637	0.259
<b>60.325</b>	100.000	25.400	25.400	19.845	3.6	3.2	115	137	20.6	3 700	4 900	22.8	73.0	67.0	89.0	96.0	3.6	3.2	0.43	1.41	0.78	0.533	0.230		
	101.600	25.400	25.400	19.845	3.6	3.2	115	137	20.6	3 700	4 900		22.8	73.0	67.0	89.0	96.0	3.6		3.2	0.43	1.41	0.78	0.533	0.269
	122.238	43.658	43.764	36.512	3.6	3.2	276	318	43.6	3 200	4 300		31.1	78.0	72.0	106.0	116.0	3.6		3.2	0.36	1.67	0.92	1.66	0.807
	127.000	36.512	36.512	26.988	3.6	1.6	209	235	36.2	3 000	4 000		32.9	80.0	73.0	113.0	121.0	3.6		1.6	0.50	1.20	0.66	1.60	0.622
	127.000	36.512	36.512	26.988	1.6	3.2	209	235	36.2	3 000	4 000		32.9	74.0	71.0	110.0	121.0	1.6		3.2	0.50	1.20	0.66	1.62	0.606
	127.000	44.450	44.450	34.925	3.6	3.2	259	269	41.0	3 300	4 400		35.2	82.0	71.0	107.0	119.0	3.6		3.2	0.49	1.23	0.68	1.59	1.02
	127.000	44.450	44.450	34.925	1.6	3.2	259	269	41.0	3 300	4 400		35.2	78.0	71.0	107.0	119.0	1.6		3.2	0.49	1.23	0.68	1.59	1.02
	136.525	46.038	46.038	36.512	3.6	3.2	290	369	49.6	2 800	3 700		37.0	84.0	78.0	118.0	132.0	3.6		3.2	0.47	1.27	0.70	2.56	0.950
<b>61.912</b>	110.000	22.000	21.996	18.824	0.8	1.2	109	116	17.7	3 400	4 500	21.3	70.0	69.0	101.0	104.5	0.8	1.2	0.40	1.49	0.82	0.606	0.259		
<b>63.500</b>	107.950	25.400	25.400	19.050	1.6	3.2	116	143	21.6	3 400	4 500	24.7	73.0	71.0	96.0	103.0	1.6	3.2	0.46	1.31	0.72	0.649	0.277		
	110.000	22.000	21.996	18.824	1.6	1.2	109	116	17.7	3 400	4 500		21.3	73.0	70.0	101.0	104.5	1.6		1.2	0.40	1.49	0.82	0.579	0.259
	110.000	22.000	21.996	18.824	3.6	1.2	109	116	17.7	3 400	4 500		21.3	77.0	70.0	101.0	104.5	3.6		1.2	0.40	1.49	0.82	0.575	0.259
	110.000	25.400	25.400	19.050	3.6	1.2	116	143	21.6	3 400	4 500		24.7	77.0	71.0	99.0	104.0	3.6		1.2	0.46	1.31	0.72	0.644	0.333
	112.712	30.162	30.162	23.812	3.6	3.2	184	207	32.1	3 300	4 500		23.3	77.0	71.0	101.0	107.0	3.6		3.2	0.34	1.77	0.97	0.908	0.355
	120.000	29.794	29.007	24.237	0.8	2.0	148	161	25.0	3 200	4 200		25.7	73.0	72.0	108.0	113.0	0.8		2.0	0.38	1.56	0.86	0.967	0.493
	122.238	38.354	38.100	29.718	3.6	3.2	238	249	39.1	3 200	4 300		27.6	80.0	73.0	108.0	116.0	3.6		3.2	0.34	1.78	0.98	1.36	0.591
	122.238	43.658	43.764	36.512	3.6	3.2	276	318	43.6	3 200	4 300		31.1	81.0	75.0	106.0	116.0	3.6		3.2	0.36	1.67	0.92	1.56	0.807
	127.000	36.512	36.170	28.575	3.6	3.2	196	226	35.3	3 000	4 000		28.6	80.0	73.0	112.0	120.0	3.6		3.2	0.36	1.65	0.91	1.43	0.648
	135.755	53.975	56.007	44.450	4.3	3.2	333	357	49.3	3 000	4 000		34.8	84.0	77.0	117.0	126.0	4.3		3.2	0.32	1.85	1.02	2.29	1.39
	136.525	41.275	41.275	31.750	3.6	3.2	302	308	48.1	2 900	3 800		30.3	82.0	78.0	121.0	129.0	3.6		3.2	0.36	1.67	0.92	2.11	0.796
<b>64.986</b>	112.712	30.162	30.924	23.812	2.4	3.2	184	207	32.1	3 300	4 500	23.3	76.0	72.0	101.0	107.0	2.4	3.2	0.34	1.77	0.97	0.845	0.355		
<b>65.000</b>	105.000	24.000	23.000	18.500	3.0	1.0	120	129	19.6	3 500	4 700	23.8	77.0	71.0	96.0	100.5	3.0	1.0	0.45	1.32	0.73	0.513	0.234		
	110.000	28.000	28.000	22.500	3.0	2.8	170	191	29.4	3 400	4 600		24.5	78.0	72.0	99.0	105.0	3.0		2.8	0.40	1.49	0.82	0.733	0.338

[Note] 1) To the bearings with supplementary code "J" attached at the front of bearing number, tolerances shown in table 7-8 on page A72 are applied.

[Remark] Inch series tapered roller bearings with bore diameter larger than 100 mm are shown in catalog "large size ball & roller bearings".

Single-row tapered roller bearings  
inch series

$d$  (65.000) ~ 68.262 mm



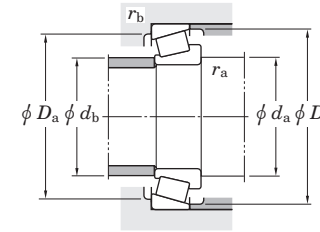
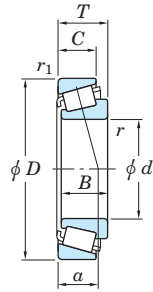
Boundary dimensions (mm)							Basic load ratings (kN)		Fatigue load limit (kN)	Limiting speeds (min <sup>-1</sup> )		Load center (mm)	Mounting dimensions (mm)						Constant e	Axial load factors		(Refer.) Mass (kg)				
$d$	$D$	$T$	$B$	$C$	$r_{min.}$	$r_{1 min.}$	$C_r$	$C_{0r}$	$C_u$	Grease lub.	Oil lub.		Inner ring	Outer ring	$d_a$	$d_b$	$D_a$	$D_b$		$r_{a max.}$	$r_{b max.}$	$Y_1$	$Y_0$	Inner ring	Outer ring	
65.000	120.000	39.000	38.500	32.000	3.0	2.8	236	255	39.7	3 200	4 300	27.9	JH211749 JH211749A	JH211710 JH211710	80.0	74.0	107.0	114.0	3.0	2.8	0.34	1.78	0.98	1.27	0.618	
	120.000	39.000	38.500	32.000	7.1	2.8	236	255	39.7	3 200	4 300				27.9	88.0	74.0	107.0	114.0	7.1	2.8	0.34	1.78	0.98	1.27	0.618
65.088	135.755	53.975	56.007	44.450	3.6	3.2	333	357	49.3	3 000	4 000	34.8	6379 H715340	6320 H715311	84.0	77.5	117.0	126.0	3.6	3.2	0.32	1.85	1.02	2.34	1.37	
	136.525	46.038	46.038	36.512	3.6	3.2	290	369	49.6	2 800	3 700				37.0	88.0	82.0	118.0	132.0	3.6	3.2	0.47	1.27	0.70	2.39	0.950
65.883	122.238	43.658	43.764	36.512	3.6	3.2	276	318	43.6	3 200	4 300	31.1	5595R	5535	83.0	77.0	106.0	116.0	3.6	3.2	0.36	1.67	0.92	1.48	0.807	
66.675	110.000	22.000	21.996	18.824	0.8	1.2	109	116	17.7	3 400	4 500	21.3	395A 395S 3984 39590 39590 33262 HM212049 HM813844 641 6386 6389 H414242 H715341	394A 394A 3925 39520 39521 33462 HM212010 HM813811 633 6320 6320 H414210 H715311	73.0	73.0	101.0	104.5	0.8	1.2	0.40	1.49	0.82	0.524	0.259	
	110.000	22.000	21.996	18.824	3.6	1.2	109	116	17.7	3 400	4 500				21.3	79.0	73.0	101.0	104.5	3.6	1.2	0.40	1.49	0.82	0.519	0.259
	112.712	30.162	30.048	23.812	3.6	0.8	139	164	25.1	3 400	4 500				25.9	80.0	74.0	101.0	106.0	3.6	0.8	0.40	1.49	0.82	0.700	0.454
	112.712	30.162	30.162	23.812	3.6	3.2	184	207	32.1	3 300	4 500				23.3	80.0	74.0	101.0	107.0	3.6	3.2	0.34	1.77	0.97	0.832	0.355
	112.712	30.162	30.162	23.812	3.6	0.8	184	207	32.1	3 300	4 500				23.3	80.0	74.0	103.0	107.0	3.6	0.8	0.34	1.77	0.97	0.832	0.360
	117.475	30.162	30.162	23.812	3.6	3.2	148	179	27.4	3 200	4 200				27.8	81.0	75.0	104.0	112.0	3.6	3.2	0.44	1.38	0.76	0.910	0.436
	122.238	38.100	38.354	29.718	3.6	1.6	238	249	39.1	3 200	4 300				27.3	82.0	75.5	110.0	116.0	3.6	1.6	0.34	1.78	0.98	1.26	0.596
	127.000	36.512	36.512	26.988	3.6	1.6	209	235	36.2	3 000	4 000				32.9	85.0	78.0	113.0	121.0	3.6	1.6	0.50	1.20	0.66	1.42	0.622
	130.175	41.275	41.275	31.750	3.6	3.2	246	267	41.8	3 000	3 900				30.3	83.0	77.0	116.0	124.0	3.6	3.2	0.36	1.66	0.91	1.68	0.703
	135.755	53.975	56.007	44.450	4.3	3.2	333	357	49.3	3 000	4 000				34.8	87.0	77.5	117.0	126.0	4.3	3.2	0.32	1.85	1.02	2.27	1.37
	135.755	53.975	56.007	44.450	6.4	3.2	333	357	49.3	3 000	4 000				34.8	91.0	77.5	117.0	126.0	6.4	3.2	0.32	1.85	1.02	2.15	1.37
	136.525	41.275	41.275	31.750	3.6	3.2	302	308	48.1	2 900	3 800				30.3	85.0	81.0	121.0	129.0	3.6	3.2	0.36	1.67	0.92	2.01	0.796
	136.525	46.038	46.038	36.512	3.6	3.2	290	369	49.6	2 800	3 700				37.0	89.0	83.0	118.0	132.0	3.6	3.2	0.47	1.27	0.70	2.33	0.950
	68.262	110.000	22.000	21.996	18.824	2.4	1.2	109	116	17.7	3 400				4 500	21.3	399A 399AS 33269 570 H414245 H715343 9185	394A 394A 33462 563 H414210 H715311 9121	78.0	74.0	101.0	104.5	2.4	1.2	0.40	1.49
110.000		22.000	21.996	18.824	5.2	1.2	109	116	17.7	3 400	4 500	21.3	83.0	74.0	101.0				104.5	5.2	1.2	0.40	1.49	0.82	0.485	0.259
117.475		30.162	30.162	23.812	3.6	3.2	148	179	27.4	3 200	4 200	27.8	82.0	76.0	104.0				112.0	3.6	3.2	0.44	1.38	0.76	0.870	0.436
127.000		36.512	36.170	28.575	3.6	3.2	196	226	35.3	3 000	4 000	28.6	83.0	77.0	112.0				120.0	3.6	3.2	0.36	1.65	0.91	1.29	0.648
136.525		41.275	41.275	31.750	3.6	3.2	284	308	46.1	2 900	3 800	30.3	86.0	82.0	121.0				129.0	3.6	3.2	0.36	1.67	0.92	1.92	0.788
136.525		46.038	46.038	36.512	3.6	3.2	290	369	49.6	2 800	3 700	37.0	90.0	84.0	118.0				132.0	3.6	3.2	0.47	1.27	0.70	2.27	0.950
152.400		47.625	46.038	31.750	3.6	3.2	306	278	38.3	2 700	3 600	44.5	94.0	81.5	130.0				145.0	3.6	3.2	0.66	0.91	0.50	2.67	1.20

[Note] 1) To the bearings with supplementary code "J" attached at the front of bearing number, tolerances shown in table 7-8 on page A72 are applied.

[Remark] Inch series tapered roller bearings with bore diameter larger than 100 mm are shown in catalog "large size ball & roller bearings".

Single-row tapered roller bearings  
inch series

$d$  69.850 ~ (73.025) mm



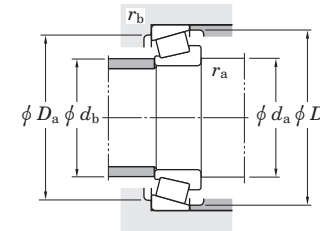
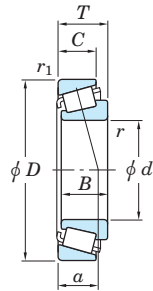
Boundary dimensions (mm)							Basic load ratings (kN)		Fatigue load limit (kN)	Limiting speeds (min <sup>-1</sup> )		Bearing No. <sup>1)</sup>	Load center (mm)	Mounting dimensions (mm)						Constant e	Axial load factors		(Refer.) Mass (kg)		
$d$	$D$	$T$	$B$	$C$	$r_{min.}$	$r_{1 min.}$	$C_r$	$C_{0r}$	$C_u$	Grease lub.	Oil lub.			Inner ring	Outer ring	$d_a$	$d_b$	$D_a$	$D_b$		$r_{a max.}$	$r_{b max.}$	$Y_1$	$Y_0$	Inner ring
<b>69.850</b>	98.425	13.495	13.495	9.525	1.6	1.6	49.1	59.8	8.45	3 500	4 700	<b>LL713049</b>	<b>LL713010</b>	18.4	77.0	74.0	92.0	94.5	1.6	1.6	0.44	1.37	0.75	0.205	0.086
	112.712	22.225	21.996	15.875	1.6	0.8	115	127	19.4	3 300	4 400	<b>LM613449</b>	<b>LM613410</b>	21.9	78.0	76.0	104.0	107.0	1.6	0.8	0.42	1.44	0.79	0.562	0.238
	112.712	25.400	25.400	19.050	1.6	3.2	122	155	23.3	3 200	4 300	<b>29675</b>	<b>29620</b>	26.2	80.0	77.0	101.0	109.0	1.6	3.2	0.49	1.23	0.68	0.676	0.270
	117.475	30.162	30.162	23.812	3.6	3.2	148	179	27.4	3 200	4 200	<b>33275</b>	<b>33462</b>	27.8	84.0	77.0	104.0	112.0	3.6	3.2	0.44	1.38	0.76	0.830	0.436
	120.000	29.002	29.007	23.444	3.6	3.2	148	161	25.0	3 200	4 200	<b>482</b>	<b>472A</b>	24.9	83.0	77.0	106.0	114.0	3.6	3.2	0.38	1.56	0.86	0.791	0.462
	120.000	29.794	29.007	24.237	3.6	2.0	148	161	25.0	3 200	4 200	<b>482</b>	<b>472</b>	25.7	83.0	77.0	108.0	113.0	3.6	2.0	0.38	1.56	0.86	0.791	0.487
	120.000	32.545	32.545	26.195	3.6	3.2	189	218	33.9	3 100	4 200	<b>47487R</b>	<b>47420</b>	26.6	84.0	78.0	107.0	114.0	3.6	3.2	0.36	1.67	0.92	1.01	0.476
	120.650	32.545	32.545	26.195	3.6	0.8	189	218	33.9	3 100	4 200	<b>47487R</b>	<b>47423</b>	26.6	84.0	78.0	109.0	114.0	3.6	0.8	0.36	1.67	0.92	1.01	0.513
	123.825	30.162	29.007	24.605	3.6	3.2	148	161	25.0	3 200	4 200	<b>482</b>	<b>472X</b>	26.0	83.0	77.0	109.0	114.0	3.6	3.2	0.38	1.56	0.86	0.791	0.625
	127.000	36.512	36.170	28.575	3.6	3.2	196	226	35.3	3 000	4 000	<b>566</b>	<b>563</b>	28.6	85.0	78.0	112.0	120.0	3.6	3.2	0.36	1.65	0.91	1.24	0.648
	146.050	41.275	41.275	31.750	3.6	3.2	261	301	45.3	2 600	3 400	<b>655</b>	<b>653</b>	33.4	88.0	82.0	131.0	139.0	3.6	3.2	0.41	1.47	0.81	2.35	0.891
	150.089	44.450	46.672	36.512	3.6	3.2	330	368	50.1	2 500	3 400	<b>745AR</b>	<b>742</b>	32.4	88.0	82.0	134.0	142.0	3.6	3.2	0.33	1.84	1.01	2.79	1.07
	168.275	53.975	56.363	41.275	3.6	3.2	429	467	62.1	2 300	3 100	<b>835R</b>	<b>832</b>	35.0	91.0	84.0	149.0	155.0	3.6	3.2	0.30	2.00	1.10	4.32	1.72
	<b>69.952</b>	121.442	24.608	23.012	17.462	2.0	2.0	113	127	19.4	3 000	4 000	<b>34274</b>	<b>34478</b>	26.8	81.0	78.0	110.0	116.0	2.0	2.0	0.45	1.33	0.73	0.764
115.000		29.000	29.000	23.000	3.0	2.5	155	173	26.6	3 200	4 300	<b>JLM813049</b>	<b>JLM813010</b>	26.1	78.0	77.0	98.0	105.0	1.0	2.5	0.49	1.23	0.68	0.590	0.300
<b>70.000</b>	110.000	26.000	25.000	20.500	1.0	2.5	129	158	23.9	3 300	4 400	<b>JM612949</b>	<b>JM612910</b>	26.2	83.0	77.0	103.0	110.0	3.0	2.5	0.43	1.39	0.77	0.776	0.358
	115.000	29.000	29.000	23.000	3.0	2.5	155	173	26.6	3 200	4 300														
<b>71.438</b>	117.475	30.162	30.162	23.812	3.6	3.2	148	179	27.4	3 200	4 200	<b>33281</b>	<b>33462</b>	27.8	85.0	79.0	104.0	112.0	3.6	3.2	0.44	1.38	0.76	0.789	0.436
	120.000	32.545	32.545	26.195	3.6	3.2	189	218	33.9	3 100	4 200	<b>47490R</b>	<b>47420</b>	26.6	86.0	79.0	107.0	114.0	3.6	3.2	0.36	1.67	0.92	0.964	0.476
	127.000	36.512	36.170	28.575	3.6	3.2	196	226	35.3	3 000	4 000	<b>567A</b>	<b>563</b>	28.6	86.0	80.0	112.0	120.0	3.6	3.2	0.36	1.65	0.91	1.19	0.648
	127.000	36.512	36.512	26.988	3.6	1.6	209	235	36.2	3 000	4 000	<b>HM813849</b>	<b>HM813811</b>	32.9	89.0	81.9	113.0	121.0	3.6	1.6	0.50	1.20	0.66	1.28	0.622
	136.525	41.275	41.275	31.750	3.6	3.2	284	308	46.1	2 900	3 800	<b>H414249</b>	<b>H414210</b>	30.3	89.0	83.3	121.0	129.0	3.6	3.2	0.36	1.67	0.92	1.80	0.788
	136.525	46.038	46.038	36.512	3.6	3.2	290	369	49.6	2 800	3 700	<b>H715345</b>	<b>H715311</b>	37.0	93.0	87.0	118.0	132.0	3.6	3.2	0.47	1.27	0.70	2.15	0.950
<b>73.025</b>	112.712	25.400	25.400	19.050	3.6	3.2	122	155	23.3	3 200	4 300	<b>29685</b>	<b>29620</b>	26.2	86.0	80.0	101.0	109.0	3.6	3.2	0.49	1.23	0.68	0.602	0.270
	117.475	30.162	30.162	23.812	3.6	3.2	148	179	27.4	3 200	4 200	<b>33287</b>	<b>33462</b>	27.8	87.0	80.0	104.0	112.0	3.6	3.2	0.44	1.38	0.76	0.747	0.436
	127.000	36.512	36.170	28.575	3.6	3.2	196	226	35.3	3 000	4 000	<b>567</b>	<b>563</b>	28.6	88.0	81.0	112.0	120.0	3.6	3.2	0.36	1.65	0.91	1.14	0.648
	139.992	36.512	36.098	28.575	3.6	3.2	220	262	39.8	2 700	3 600	<b>576R</b>	<b>572</b>	31.0	90.0	83.0	125.0	133.0	3.6	3.2	0.40	1.49	0.82	1.74	0.779

[Note] 1) To the bearings with supplementary code "J" attached at the front of bearing number, tolerances shown in table 7-8 on page A72 are applied.

[Remark] Inch series tapered roller bearings with bore diameter larger than 100 mm are shown in catalog "large size ball & roller bearings".

Single-row tapered roller bearings  
inch series

$d$  (73.025) ~ 76.200 mm



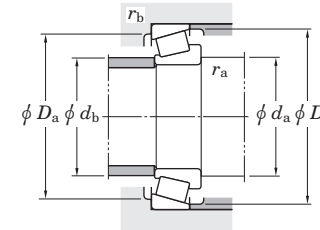
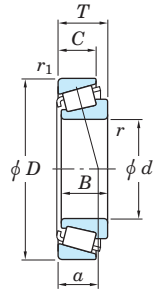
Boundary dimensions (mm)							Basic load ratings (kN)		Fatigue load limit (kN)	Limiting speeds (min <sup>-1</sup> )		Load center (mm)	Mounting dimensions (mm)						Constant $e$	Axial load factors		(Refer.) Mass (kg)						
$d$	$D$	$T$	$B$	$C$	$r_{min.}$	$r_{1 min.}$	$C_r$	$C_{0r}$	$C_u$	Grease lub.	Oil lub.		Inner ring	Outer ring	$d_a$	$d_b$	$D_a$	$D_b$		$r_{a max.}$	$r_{b max.}$	$Y_1$	$Y_0$	Inner ring	Outer ring			
<b>73.025</b>	146.050	41.275	41.275	31.750	3.6	3.2	261	301	45.3	2 600	3 400	33.4	<b>657</b>	<b>653</b>	90.0	85.0	131.0	139.0	3.6	3.2	0.41	1.47	0.81	2.28	0.880			
	149.225	53.975	54.229	44.450	3.6	3.2	357	404	54.4	2 700	3 500				39.3	<b>6460</b>	<b>6420</b>	93.0	87.0	129.0	141.0	3.6	3.2	0.36	1.66	0.91	2.79	1.61
	150.089	44.450	46.672	36.512	3.6	3.2	330	368	50.1	2 500	3 400				32.4	<b>744R</b>	<b>742</b>	91.0	85.0	134.0	142.0	3.6	3.2	0.33	1.84	1.01	2.66	1.07
	161.925	47.625	48.260	38.100	3.6	3.2	342	391	52.4	2 400	3 200				35.5	<b>762</b>	<b>752</b>	92.0	97.0	144.0	150.0	3.6	3.2	0.34	1.76	0.97	3.18	1.61
<b>73.817</b>	112.712	25.400	25.400	19.050	1.6	3.2	122	155	23.3	3 200	4 300	26.2	<b>29688</b>	<b>29620</b>	83.0	81.0	101.0	109.0	1.6	3.2	0.49	1.23	0.68	0.588	0.270			
	127.000	36.512	36.170	28.575	0.8	3.2	196	226	35.3	3 000	4 000				28.6	<b>568</b>	<b>563</b>	83.0	82.0	112.0	120.0	0.8	3.2	0.36	1.65	0.91	1.12	0.648
<b>74.612</b>	139.992	36.512	36.098	28.575	3.6	3.2	220	262	39.8	2 700	3 600	31.0	<b>577R</b>	<b>572</b>	91.0	85.0	125.0	133.0	3.6	3.2	0.40	1.49	0.82	1.69	0.779			
<b>75.000</b>	115.000	25.000	25.000	19.000	3.0	2.8	127	151	23.0	3 100	4 200	25.5	<b>JLM714149</b>	<b>JLM714110</b>	87.0	81.0	104.0	110.0	3.0	2.8	0.46	1.31	0.72	0.612	0.269			
	120.000	31.000	29.500	25.000	3.0	2.8	182	216	33.2	3 100	4 100				30.0	<b>JM714249</b>	<b>JM714210</b>	88.0	82.9	108.0	115.0	3.0	2.8	0.44	1.35	0.74	0.846	0.430
	145.000	51.000	51.000	42.000	3.0	2.5	362	412	55.2	2 700	3 600				36.6	<b>JH415647</b>	<b>JH415610</b>	94.0	89.0	129.0	139.0	3.0	2.5	0.36	1.66	0.91	2.66	1.18
<b>76.200</b>	121.442	24.608	23.012	17.462	3.6	2.0	113	127	19.4	3 000	4 000	26.8	<b>34301</b>	<b>34478</b>	89.0	83.0	110.0	116.0	3.6	2.0	0.45	1.33	0.73	0.617	0.313			
	127.000	30.162	31.000	22.225	3.6	3.2	179	225	32.3	2 400	3 200				27.1	<b>42687</b>	<b>42620</b>	90.0	84.0	114.0	121.0	3.6	3.2	0.42	1.43	0.79	1.05	0.434
	127.000	30.162	31.000	22.225	6.4	3.2	179	225	32.3	2 400	3 200				27.1	<b>42688</b>	<b>42620</b>	96.0	84.0	114.0	121.0	6.4	3.2	0.42	1.43	0.79	1.04	0.434
	133.350	30.162	29.769	22.225	6.4	3.2	167	198	30.0	2 700	3 600				29.8	<b>495AX</b>	<b>492A</b>	98.0	86.0	120.0	128.0	6.4	3.2	0.44	1.35	0.74	1.20	0.430
	133.350	33.338	33.338	26.195	6.4	3.2	193	245	37.2	2 700	3 700				29.2	<b>47678R</b>	<b>47620</b>	97.0	90.0	119.0	128.0	6.4	3.2	0.40	1.48	0.82	1.29	0.577
	133.350	33.338	33.338	26.195	0.8	3.2	193	245	37.2	2 700	3 700				29.2	<b>47680R</b>	<b>47620</b>	86.0	85.0	119.0	128.0	0.8	3.2	0.40	1.48	0.82	1.39	0.577
	135.733	44.450	46.101	34.925	3.6	3.2	267	337	51.0	2 800	3 700				33.0	<b>5760</b>	<b>5735</b>	94.0	88.0	119.0	130.0	3.6	3.2	0.41	1.48	0.81	1.85	0.877
	136.525	30.162	29.769	22.225	3.6	3.2	167	198	30.0	2 700	3 600				29.8	<b>495A</b>	<b>493</b>	92.0	86.0	122.0	130.0	3.6	3.2	0.44	1.35	0.74	1.26	0.544
	139.992	36.512	36.098	28.575	3.6	3.2	220	262	39.8	2 700	3 600				31.0	<b>575R</b>	<b>572</b>	92.0	86.0	125.0	133.0	3.6	3.2	0.40	1.49	0.82	1.64	0.779
	139.992	36.512	36.098	28.575	6.7	3.2	220	262	39.8	2 700	3 600				31.0	<b>575SR</b>	<b>572</b>	99.0	86.0	125.0	133.0	6.7	3.2	0.40	1.49	0.82	1.61	0.779
	149.225	53.975	54.229	44.450	3.6	3.2	357	404	54.4	2 700	3 500				39.3	<b>6461</b>	<b>6420</b>	96.0	89.5	129.0	141.0	3.6	3.2	0.36	1.66	0.91	2.64	1.61
	149.225	53.975	54.229	44.450	9.5	3.2	357	404	54.4	2 700	3 500				39.3	<b>6461A</b>	<b>6420</b>	105.0	90.0	129.0	141.0	9.5	3.2	0.36	1.66	0.91	2.60	1.61
	150.089	44.450	46.672	36.512	3.6	3.2	330	368	50.1	2 500	3 400				32.4	<b>748SR</b>	<b>742</b>	93.0	87.0	134.0	142.0	3.6	3.2	0.33	1.84	1.01	2.51	1.06
	152.400	41.275	41.275	31.750	3.6	3.2	261	301	45.3	2 600	3 400				33.4	<b>659</b>	<b>652</b>	93.0	87.0	134.0	141.0	3.6	3.2	0.41	1.47	0.81	2.16	1.25
	190.500	57.150	57.531	46.038	3.6	3.2	549	602	76.9	2 000	2 700				42.5	<b>HH221430</b>	<b>HH221410</b>	101.0	95.0	171.0	179.0	3.6	3.2	0.33	1.79	0.99	6.33	2.21

[Note] 1) To the bearings with supplementary code "J" attached at the front of bearing number, tolerances shown in table 7-8 on page A72 are applied.

[Remark] Inch series tapered roller bearings with bore diameter larger than 100 mm are shown in catalog "large size ball & roller bearings".

Single-row tapered roller bearings  
inch series

$d$  77.788 ~ (83.345) mm



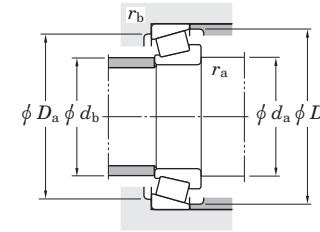
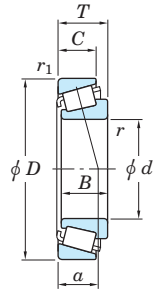
Boundary dimensions (mm)							Basic load ratings (kN)		Fatigue load limit (kN)	Limiting speeds (min <sup>-1</sup> )		Load center (mm)	Mounting dimensions (mm)						Constant e	Axial load factors		(Refer.) Mass (kg)			
$d$	$D$	$T$	$B$	$C$	$r_{min.}$	$r_{1 min.}$	$C_r$	$C_{0r}$	$C_u$	Grease lub.	Oil lub.		Inner ring	Outer ring	$d_a$	$d_b$	$D_a$	$D_b$		$r_{a max.}$	$r_{b max.}$	$Y_1$	$Y_0$	Inner ring	Outer ring
<b>77.788</b>	117.475	25.400	25.400	19.050	3.6	3.2	127	166	25.1	3 100	4 100	<b>LM814849</b>	<b>LM814810</b>	27.6	91.0	85.0	105.0	113.0	3.6	3.2	0.51	1.18	0.65	0.619	0.295
	121.442	24.608	23.012	17.462	3.6	2.0	113	127	19.4	3 000	4 000	<b>34306</b>	<b>34478</b>	26.8	90.0	84.0	110.0	116.0	3.6	2.0	0.45	1.33	0.73	0.583	0.313
	121.442	24.608	23.012	17.462	6.4	2.0	113	127	19.4	3 000	4 000	<b>34307</b>	<b>34478</b>	26.8	96.0	84.0	110.0	116.0	6.4	2.0	0.45	1.33	0.73	0.571	0.313
	127.000	30.162	31.000	22.225	3.6	3.2	179	225	32.3	2 400	3 200	<b>42690</b>	<b>42620</b>	27.1	91.0	85.0	114.0	121.0	3.6	3.2	0.42	1.43	0.79	1.00	0.434
<b>79.375</b>	146.050	41.275	41.275	31.750	3.6	3.2	261	301	45.3	2 600	3 400	<b>661</b>	<b>653</b>	33.4	96.0	90.0	131.0	139.0	3.6	3.2	0.41	1.47	0.81	2.04	0.880
	161.925	47.625	48.260	38.100	7.9	3.2	342	391	52.4	2 400	3 200	<b>756A</b>	<b>752</b>	35.5	106.0	91.0	144.0	150.0	7.9	3.2	0.34	1.76	0.97	2.95	1.59
	190.500	57.150	57.531	46.038	3.6	3.2	549	602	76.9	2 000	2 700	<b>HH221431</b>	<b>HH221410</b>	42.5	103.0	97.0	171.0	179.0	3.6	3.2	0.33	1.79	0.99	6.16	2.21
<b>80.000</b>	130.000	35.000	34.000	28.500	3.2	2.5	211	256	39.3	2 800	3 800	<b>JM515649</b>	<b>JM515610</b>	29.6	94.0	88.0	117.0	125.0	3.2	2.5	0.39	1.54	0.85	1.19	0.575
	200.000	52.761	49.212	34.925	3.6	3.2	433	471	58.8	1 400	1 900	<b>98316</b>	<b>98788</b>	54.5	111.0	105.0	174.0	188.0	3.6	3.2	0.63	0.95	0.52	5.73	2.28
<b>80.962</b>	133.350	30.162	29.769	22.225	3.6	3.2	167	198	30.0	2 700	3 600	<b>496</b>	<b>492A</b>	29.8	95.0	89.0	120.0	128.0	3.6	3.2	0.44	1.35	0.74	1.12	0.429
	133.350	33.338	33.338	26.195	3.6	3.2	193	245	37.2	2 700	3 700	<b>47681R</b>	<b>47620</b>	29.2	95.0	89.0	119.0	128.0	3.6	3.2	0.40	1.48	0.82	1.17	0.577
	139.992	36.512	36.098	28.575	3.6	3.2	220	262	39.8	2 700	3 600	<b>581R</b>	<b>572</b>	31.0	96.0	90.0	125.0	133.0	3.6	3.2	0.40	1.49	0.82	1.47	0.779
	150.089	44.450	46.672	36.512	5.2	3.2	330	368	50.1	2 500	3 400	<b>740R</b>	<b>742</b>	32.4	101.0	91.0	134.0	142.0	5.2	3.2	0.33	1.84	1.01	2.30	1.06
<b>82.550</b>	125.412	25.400	25.400	19.845	3.6	1.6	126	162	24.4	2 900	3 800	<b>27687</b>	<b>27620</b>	24.7	96.0	89.0	115.0	120.0	3.6	1.6	0.42	1.44	0.79	0.710	0.344
	133.350	30.162	29.769	22.225	3.6	3.2	167	198	30.0	2 700	3 600	<b>495</b>	<b>492A</b>	29.8	97.0	90.0	120.0	128.0	3.6	3.2	0.44	1.35	0.74	1.08	0.429
	133.350	33.338	33.338	26.195	3.6	0.8	193	245	37.2	2 700	3 700	<b>47686R</b>	<b>47620A</b>	29.2	97.0	90.0	121.0	128.0	3.6	0.8	0.40	1.48	0.82	1.13	0.577
	133.350	39.688	39.688	32.545	6.7	3.2	222	306	45.9	2 800	3 700	<b>HM516448</b>	<b>HM516410</b>	32.2	105.0	92.0	118.0	128.0	6.7	3.2	0.40	1.49	0.82	1.33	0.763
	139.700	36.512	36.098	28.575	3.6	3.2	220	262	39.8	2 700	3 600	<b>580R</b>	<b>572X</b>	31.0	98.0	91.0	125.0	133.0	3.6	3.2	0.40	1.49	0.82	1.41	0.765
	139.992	36.512	36.098	28.575	3.6	3.2	220	262	39.8	2 700	3 600	<b>580R</b>	<b>572</b>	31.0	98.0	91.0	125.0	133.0	3.6	3.2	0.40	1.49	0.82	1.41	0.779
	139.992	36.512	36.098	28.575	6.7	3.2	220	262	39.8	2 700	3 600	<b>582R</b>	<b>572</b>	31.0	104.0	91.0	125.0	133.0	6.7	3.2	0.40	1.49	0.82	1.40	0.779
	146.050	41.275	41.275	31.750	3.6	3.2	261	301	45.3	2 600	3 400	<b>663</b>	<b>653</b>	33.4	99.0	92.0	131.0	139.0	3.6	3.2	0.41	1.47	0.81	1.91	0.880
	150.089	44.450	46.672	36.512	3.6	3.2	330	368	50.1	2 500	3 400	<b>749AR</b>	<b>742</b>	32.4	99.0	93.0	134.0	142.0	3.6	3.2	0.33	1.84	1.01	2.23	1.06
	150.089	44.450	46.672	36.512	6.7	3.2	330	368	50.1	2 500	3 400	<b>750AR</b>	<b>742</b>	32.4	106.0	93.0	134.0	142.0	6.7	3.2	0.33	1.84	1.01	2.19	1.06
	161.925	47.625	48.260	38.100	3.6	3.2	342	391	52.4	2 400	3 200	<b>757</b>	<b>752</b>	35.5	100.0	94.0	144.0	150.0	3.6	3.2	0.34	1.76	0.97	2.83	1.59
<b>83.345</b>	125.412	25.400	25.400	19.845	0.8	1.6	126	162	24.4	2 900	3 800	<b>27689</b>	<b>27620</b>	24.7	90.0	90.0	115.0	120.0	0.8	1.6	0.42	1.44	0.79	0.746	0.344

[Note] 1) To the bearings with supplementary code "J" attached at the front of bearing number, tolerances shown in table 7-8 on page A72 are applied.

[Remark] Inch series tapered roller bearings with bore diameter larger than 100 mm are shown in catalog "large size ball & roller bearings".

Single-row tapered roller bearings  
inch series

$d$  (83.345) ~ (88.900) mm



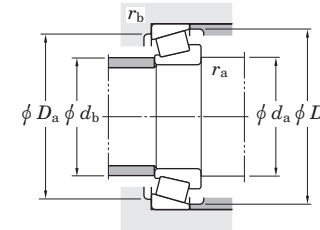
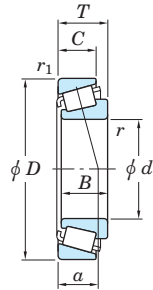
Boundary dimensions (mm)							Basic load ratings (kN)		Fatigue load limit (kN)	Limiting speeds (min <sup>-1</sup> )		Load center (mm)	Mounting dimensions (mm)						Constant e	Axial load factors		(Refer.) Mass (kg)				
$d$	$D$	$T$	$B$	$C$	$r_{min.}$	$r_{1 min.}$	$C_r$	$C_{0r}$	$C_u$	Grease lub.	Oil lub.		$a$	$d_a$	$d_b$	$D_a$	$D_b$	$r_{a max.}$		$r_{b max.}$	$Y_1$	$Y_0$	Inner ring	Outer ring		
<b>83.345</b>	125.412	25.400	25.400	19.845	3.6	1.6	126	162	24.4	2 900	3 800		<b>27690</b>	<b>27620</b>	24.7	96.0	90.0	115.0	120.0	3.6	1.6	0.42	1.44	0.79	0.689	0.344
	125.412	25.400	25.400	19.845	6.4	1.6	126	162	24.4	2 900	3 800		<b>27691</b>	<b>27620</b>	24.7	102.0	90.0	115.0	120.0	6.4	1.6	0.42	1.44	0.79	0.646	0.344
<b>84.138</b>	133.350	30.162	29.769	22.225	3.6	3.2	167	198	30.0	2 700	3 600		<b>498</b>	<b>492A</b>	29.8	98.0	91.0	120.0	128.0	3.6	3.2	0.44	1.35	0.74	1.04	0.429
<b>85.000</b>	130.000	30.000	29.000	24.000	3.0	2.5	179	228	34.5	2 800	3 700		<b>JM716649</b>	<b>JM716610</b>	29.1	98.0	92.0	117.0	125.0	3.0	2.5	0.44	1.35	0.74	0.937	0.456
	140.000	39.000	38.000	31.500	3.0	2.5	254	308	46.4	2 700	3 500		<b>JHM516849</b>	<b>JHM516810</b>	32.8	100.0	93.9	125.0	134.0	3.0	2.5	0.41	1.47	0.81	1.54	0.759
	150.000	46.000	46.000	38.000	3.0	2.5	342	390	53.1	2 500	3 400		<b>JH217249</b>	<b>JH217210</b>	33.6	101.0	95.2	134.0	142.0	3.0	2.5	0.33	1.80	0.99	2.28	1.08
	200.000	52.761	49.212	34.925	3.6	3.2	433	471	58.8	1 400	1 900		<b>98335</b>	<b>98788</b>	54.5	115.0	109.0	174.0	188.0	3.6	3.2	0.63	0.95	0.52	5.47	2.28
<b>85.026</b>	150.089	44.450	46.672	36.512	3.6	3.2	330	368	50.1	2 500	3 400		<b>749R</b>	<b>742</b>	32.4	101.0	95.0	134.0	142.0	3.6	3.2	0.33	1.84	1.01	2.12	1.06
	150.089	44.450	46.672	36.512	5.2	3.2	330	368	50.1	2 500	3 400		<b>749SR</b>	<b>742</b>	32.4	104.0	95.0	134.0	142.0	5.2	3.2	0.33	1.84	1.01	2.08	1.06
<b>85.725</b>	133.350	30.162	29.769	22.225	3.6	3.2	167	198	30.0	2 700	3 600		<b>497</b>	<b>492A</b>	29.8	99.0	93.0	120.0	128.0	3.6	3.2	0.44	1.35	0.74	0.978	0.429
	136.525	30.162	29.769	22.225	6.4	3.2	167	198	30.0	2 700	3 600		<b>497A</b>	<b>493</b>	29.8	105.0	93.0	122.0	130.0	6.4	3.2	0.44	1.35	0.74	0.965	0.544
	142.138	42.862	42.862	34.133	4.8	3.2	276	351	52.4	2 600	3 500		<b>HM617049</b>	<b>HM617010</b>	35.2	106.0	95.7	125.0	137.0	4.8	3.2	0.43	1.39	0.76	1.72	0.902
	146.050	41.275	41.275	31.750	3.6	3.2	261	301	45.3	2 600	3 400		<b>665</b>	<b>653</b>	33.4	102.0	95.0	131.0	139.0	3.6	3.2	0.41	1.47	0.81	1.77	0.880
	146.050	41.275	41.275	31.750	6.4	3.2	261	301	45.3	2 600	3 400		<b>665A</b>	<b>653</b>	33.4	107.0	95.0	131.0	139.0	6.4	3.2	0.41	1.47	0.81	1.76	0.880
	152.400	39.688	36.322	30.162	3.6	3.2	230	287	42.5	2 400	3 300		<b>596</b>	<b>592A</b>	37.1	102.0	96.0	135.0	144.0	3.6	3.2	0.44	1.36	0.75	1.83	1.04
	161.925	47.625	48.260	38.100	3.6	3.2	342	391	52.4	2 400	3 200		<b>758</b>	<b>752</b>	35.5	103.0	97.0	144.0	150.0	3.6	3.2	0.34	1.76	0.97	2.67	1.59
	168.275	41.275	41.275	30.162	3.6	3.2	282	349	50.4	2 200	3 000		<b>677</b>	<b>672</b>	38.6	105.0	99.0	149.0	160.0	3.6	3.2	0.47	1.28	0.70	2.89	1.22
	168.275	53.975	56.363	41.275	3.6	3.2	429	467	62.1	2 300	3 100		<b>841R</b>	<b>832</b>	35.0	104.0	97.0	149.0	155.0	3.6	3.2	0.30	2.00	1.10	3.47	1.72
	<b>88.900</b>	123.825	20.638	20.638	16.670	1.6	1.6	102	145	21.5	2 800	3 700		<b>L217849</b>	<b>L217810</b>	20.7	97.0	94.0	116.0	119.0	1.6	1.6	0.33	1.82	1.00	0.507
152.400		39.688	39.688	30.162	6.4	3.2	311	359	53.5	2 400	3 200		<b>HM518445</b>	<b>HM518410</b>	33.1	110.0	98.0	135.0	146.0	6.4	3.2	0.40	1.49	0.82	2.10	0.768
161.925		47.625	48.260	38.100	3.6	3.2	342	391	52.4	2 400	3 200		<b>759</b>	<b>752</b>	35.5	106.0	99.0	144.0	150.0	3.6	3.2	0.34	1.76	0.97	2.50	1.59
161.925		47.625	48.260	38.100	7.1	3.2	342	391	52.4	2 400	3 200		<b>766</b>	<b>752</b>	35.5	113.0	99.0	144.0	150.0	7.1	3.2	0.34	1.76	0.97	2.48	1.59
161.925		53.975	55.100	42.862	3.6	3.2	395	471	61.4	2 400	3 200		<b>6580R</b>	<b>6535</b>	49.8	109.0	98.0	141.0	154.0	3.6	3.2	0.40	1.50	0.82	3.09	1.65
168.275		41.275	41.275	30.162	3.6	3.2	282	349	50.4	2 200	3 000		<b>679</b>	<b>672</b>	38.6	107.0	101.0	149.0	160.0	3.6	3.2	0.47	1.28	0.70	2.75	1.22
190.500		57.150	57.531	44.450	7.9	3.2	482	565	72.4	2 100	2 700		<b>855R</b>	<b>854</b>	40.0	118.0	103.0	170.0	174.0	7.9	3.2	0.33	1.79	0.99	5.05	2.66

[Note] 1) To the bearings with supplementary code "J" attached at the front of bearing number, tolerances shown in table 7-8 on page A72 are applied.

[Remark] Inch series tapered roller bearings with bore diameter larger than 100 mm are shown in catalog "large size ball & roller bearings".

Single-row tapered roller bearings  
inch series

$d$  (88.900) ~ 99.975 mm



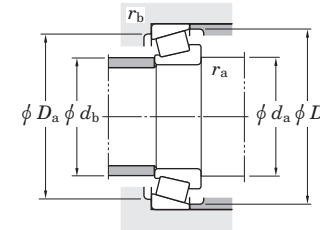
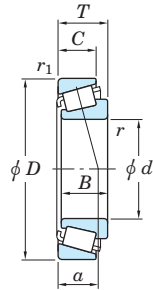
Boundary dimensions (mm)							Basic load ratings (kN)		Fatigue load limit (kN)	Limiting speeds (min <sup>-1</sup> )		Inner ring	Outer ring	Load center (mm)	Mounting dimensions (mm)						Constant $e$	Axial load factors		(Refer.) Mass (kg)			
$d$	$D$	$T$	$B$	$C$	$r_{min.}$	$r_{1 min.}$	$C_r$	$C_{0r}$	$C_u$	Grease lub.	Oil lub.				$a$	$d_a$	$d_b$	$D_a$	$D_b$	$r_{a max.}$		$r_{b max.}$	$Y_1$	$Y_0$	Inner ring	Outer ring	
<b>88.900</b>	190.500	57.150	57.531	46.038	7.9	3.2	549	602	76.9	2 000	2 700	<b>HH221434</b>	<b>HH221410</b>	42.5	120.0	105.0	171.0	179.0	7.9	3.2	0.33	1.79	0.99	5.57	2.21		
	200.000	52.761	49.212	34.925	3.6	3.2	433	471	58.8	1 400	1 900				54.5	118.0	112.0	174.0	188.0	3.6		3.2	0.63	0.95	0.52	5.27	2.28
<b>89.974</b>	146.975	40.000	40.000	32.500	7.1	3.6	259	310	46.6	2 500	3 300	<b>HM218248</b>	<b>HM218210</b>	30.8	112.0	99.0	133.0	141.0	7.1	3.6	0.33	1.80	0.99	1.66	0.784		
<b>90.000</b>	145.000	35.000	34.000	27.000	3.0	2.5	244	291	43.5	2 500	3 400	<b>JM718149</b>	<b>JM718110</b>	32.7	105.0	99.0	131.0	139.0	3.0	2.5	0.44	1.35	0.74	1.47	0.652		
	155.000	44.000	44.000	35.500	3.0	2.5	363	407	54.8	2 400	3 200				34.5	106.0	100.0	140.0	148.0	3.0		2.5	0.34	1.76	0.97	2.37	1.00
	161.925	53.975	55.100	42.862	3.0	3.2	395	471	61.4	2 400	3 200				41.0	102.0	98.0	141.0	154.0	3.0		3.2	0.40	1.50	0.82	3.02	1.65
<b>90.488</b>	161.925	47.625	48.260	38.100	3.6	3.2	342	391	52.4	2 400	3 200	<b>760</b>	<b>752</b>	35.5	107.0	101.0	144.0	150.0	3.6	3.2	0.34	1.76	0.97	2.42	1.59		
<b>92.075</b>	146.050	33.338	34.925	26.195	3.6	3.2	223	293	43.2	2 500	3 300	<b>47890R</b>	<b>47820</b>	32.6	107.0	101.0	131.0	140.0	3.6	3.2	0.45	1.34	0.74	1.46	0.657		
	168.275	41.275	41.275	30.162	3.6	3.2	282	349	50.4	2 200	3 000				38.6	110.0	104.0	149.0	160.0	3.6		3.2	0.47	1.28	0.70	2.61	1.22
	168.275	41.275	41.275	30.162	6.4	3.2	282	349	50.4	2 200	3 000				38.6	116.0	104.0	149.0	160.0	6.4		3.2	0.47	1.28	0.70	2.60	1.22
	180.975	47.625	48.006	38.100	3.6	3.2	362	438	56.6	2 100	2 800				39.5	111.0	105.0	161.0	168.0	3.6		3.2	0.39	1.56	0.86	3.65	1.92
	190.500	57.150	57.531	44.450	7.9	3.2	482	565	72.4	2 100	2 700				39.9	121.0	106.0	170.0	174.0	7.9		3.2	0.33	1.79	0.99	4.86	2.66
<b>95.000</b>	150.000	35.000	34.000	27.000	3.0	2.5	235	294	43.4	2 400	3 300	<b>JM719149</b>	<b>JM719113</b>	33.5	109.0	104.0	135.0	143.0	3.0	2.5	0.44	1.36	0.75	1.43	0.766		
<b>95.250</b>	128.588	15.875	15.083	11.908	1.6	1.6	72.6	93.0	13.1	2 600	3 500	<b>LL319349</b>	<b>LL319310</b>	20.3	103.0	100.0	122.0	125.0	1.6	1.6	0.35	1.71	0.94	0.393	0.147		
	130.175	20.638	21.432	16.670	1.6	1.6	121	167	24.7	2 600	3 500				22.2	107.0	101.0	122.0	125.0	1.6		1.6	0.35	1.72	0.95	0.548	0.246
	146.050	33.338	34.925	26.195	3.6	3.2	223	293	43.2	2 500	3 300				32.6	110.0	103.0	131.0	140.0	3.6		3.2	0.45	1.34	0.74	1.34	0.657
	147.638	35.717	36.322	26.192	5.2	0.8	230	287	42.5	2 400	3 300				33.4	113.0	104.0	135.0	142.0	5.2		0.8	0.44	1.36	0.75	1.45	0.620
	157.162	36.512	36.116	26.195	3.6	3.2	227	288	41.7	2 300	3 000				36.0	112.0	105.0	142.0	153.0	3.6		3.2	0.47	1.26	0.69	1.94	0.694
	168.275	41.275	41.275	30.162	3.6	3.2	282	349	50.4	2 200	3 000				38.6	113.0	106.0	149.0	160.0	3.6		3.2	0.47	1.28	0.70	2.46	1.22
	190.500	57.150	57.531	44.450	7.9	3.2	482	565	72.4	2 100	2 700				39.9	123.0	108.0	170.0	174.0	7.9		3.2	0.33	1.79	0.99	4.64	2.66
	190.500	57.150	57.531	46.038	7.9	3.2	549	602	76.9	2 000	2 700				42.5	125.0	110.0	171.0	179.0	7.9		3.2	0.33	1.79	0.99	5.16	2.21
	<b>98.425</b>	168.275	41.275	41.275	30.162	3.6	3.2	282	349	50.4	2 200				3 000	<b>685</b>	<b>672</b>	38.6	116.0	109.0		149.0	160.0	3.6	3.2	0.47	1.28
	190.500	57.150	57.531	46.038	3.6	3.2	549	602	76.9	2 000	2 700	<b>HH221442</b>	<b>HH221410</b>	42.5	119.0	113.0	171.0	179.0	3.6	3.2	0.33	1.79	0.99	4.97	2.21		
<b>99.975</b>	212.725	66.675	66.675	53.975	3.6	3.2	641	699	87.1	1 800	2 400	<b>HH224334</b>	<b>HH224310</b>	47.6	122.0	117.0	192.0	202.0	3.6	3.2	0.33	1.84	1.01	7.91	3.03		

[Note] 1) To the bearings with supplementary code "J" attached at the front of bearing number, tolerances shown in table 7-8 on page A72 are applied.

[Remark] Inch series tapered roller bearings with bore diameter larger than 100 mm are shown in catalog "large size ball & roller bearings".

Single-row tapered roller bearings  
inch series

$d$  99.982 ~ (107.950) mm



$d$	Boundary dimensions (mm)					Basic load ratings (kN)		Fatigue load limit (kN) $C_u$	Limiting speeds ( $\text{min}^{-1}$ )		Bearing No. <sup>1)</sup>	Load center (mm) $a$	Mounting dimensions (mm)					Constant $e$	Axial load factors		(Refer.) Mass (kg)				
	$D$	$T$	$B$	$C$	$r_{\text{min}}$	$r_{1 \text{ min}}$	$C_r$		$C_{0r}$	Grease lub.			Oil lub.	Inner ring	Outer ring	$d_a$	$d_b$		$D_a$	$D_b$	$r_{a \text{ max}}$	$r_{b \text{ max}}$	$Y_1$	$Y_0$	Inner ring
<b>99.982</b>	190.500	57.150	57.531	46.038	6.4	3.2	549	602	76.9	2 000	2 700	<b>HH221447</b>	<b>HH221410</b>	42.5	126.0	114.0	171.0	179.0	6.4	3.2	0.33	1.79	0.99	4.84	2.21
<b>100.000</b>	155.000	36.000	35.000	28.000	3.0	2.5	256	328	47.7	2 300	3 100	<b>JM720249</b>	<b>JM720210</b>	35.6	110.0	110.0	139.0	148.0	3.0	2.5	0.47	1.27	0.70	1.64	0.763
	160.000	41.000	40.000	32.000	3.0	2.5	298	378	54.6	2 300	3 000	<b>JHM720249</b>	<b>JHM720210</b>	38.3	110.0	111.0	143.0	153.0	3.0	2.5	0.47	1.28	0.70	2.11	0.964
<b>100.012</b>	157.162	36.512	36.116	26.195	3.6	3.2	227	288	41.7	2 300	3 000	<b>52393</b>	<b>52618</b>	36.0	113.0	115.0	142.0	153.0	3.6	3.2	0.47	1.26	0.69	1.74	0.694
<b>101.600</b>	157.162	36.512	36.116	26.195	3.6	3.2	227	288	41.7	2 300	3 000	<b>52400</b>	<b>52618</b>	36.0	114.0	115.0	142.0	153.0	3.6	3.2	0.47	1.26	0.69	1.67	0.694
	157.162	36.512	36.116	26.195	7.9	3.2	227	288	41.7	2 300	3 000	<b>52401</b>	<b>52618</b>	36.0	126.0	111.0	142.0	153.0	7.9	3.2	0.47	1.26	0.69	1.64	0.694
	168.275	41.275	41.275	30.162	3.6	3.2	282	349	50.4	2 200	3 000	<b>687</b>	<b>672</b>	38.6	114.0	115.0	146.0	157.0	3.6	3.2	0.47	1.28	0.70	2.15	1.22
	180.975	47.625	48.006	38.100	3.6	3.2	362	438	56.6	2 100	2 800	<b>780</b>	<b>772</b>	39.5	114.0	120.0	156.0	165.0	3.6	3.2	0.39	1.56	0.86	3.09	1.92
	190.500	57.150	57.531	44.450	7.9	3.2	482	565	72.4	2 100	2 700	<b>861R</b>	<b>854</b>	39.9	129.0	114.0	170.0	174.0	7.9	3.2	0.33	1.79	0.99	4.20	2.66
	190.500	57.150	57.531	46.038	7.9	3.2	549	602	76.9	2 000	2 700	<b>HH221449</b>	<b>HH221410</b>	42.5	123.0	119.0	168.0	178.0	7.9	3.2	0.33	1.79	0.99	4.72	2.21
	200.000	52.761	49.212	34.925	3.6	3.2	433	471	58.8	1 400	1 900	<b>98400</b>	<b>98788</b>	54.5	114.0	123.0	170.0	185.0	3.6	3.2	0.63	0.95	0.52	4.55	2.28
	212.725	66.675	66.675	53.975	7.1	3.2	563	674	84.1	1 800	2 400	<b>941</b>	<b>932</b>	47.6	121.0	135.0	181.0	192.0	7.1	3.2	0.33	1.84	1.01	7.07	4.07
212.725	66.675	66.675	53.975	7.1	3.2	641	699	87.1	1 800	2 400	<b>HH224335</b>	<b>HH224310</b>	47.6	121.0	134.0	189.0	201.0	7.1	3.2	0.33	1.84	1.01	7.76	3.03	
<b>104.775</b>	180.975	47.625	48.006	38.100	3.6	3.2	362	438	56.6	2 100	2 800	<b>782</b>	<b>772</b>	39.5	117.0	120.0	156.0	165.0	3.6	3.2	0.39	1.56	0.86	2.90	1.92
	180.975	47.625	48.006	38.100	6.4	3.2	362	438	56.6	2 100	2 800	<b>786</b>	<b>772</b>	39.5	123.0	120.0	156.0	165.0	6.4	3.2	0.39	1.56	0.86	2.88	1.92
	180.975	47.625	48.006	38.100	7.1	3.2	362	438	56.6	2 100	2 800	<b>787</b>	<b>772</b>	39.5	129.0	116.0	161.0	168.0	7.1	3.2	0.39	1.56	0.86	2.87	1.92
	190.500	47.625	49.212	34.925	3.6	3.2	381	483	60.9	1 900	2 600	<b>71412</b>	<b>71750</b>	40.9	117.0	131.0	167.0	177.0	3.6	3.2	0.42	1.44	0.79	3.96	1.72
<b>106.362</b>	165.100	36.512	36.512	26.988	3.6	3.2	245	325	46.3	2 200	2 900	<b>56418R</b>	<b>56650</b>	38.6	122.0	116.0	149.0	159.0	3.6	3.2	0.50	1.21	0.66	1.84	0.852
<b>107.950</b>	146.050	21.432	21.432	16.670	1.6	1.6	108	167	23.5	2 300	3 100	<b>L521949R</b>	<b>L521910</b>	26.2	116.0	114.0	136.0	141.0	1.6	1.6	0.39	1.53	0.84	0.665	0.325
	158.750	23.020	21.438	15.875	3.6	3.2	130	169	23.9	2 200	3 000	<b>37425</b>	<b>37625</b>	36.5	121.0	121.0	141.0	148.0	3.6	3.2	0.61	0.99	0.54	0.893	0.484
	159.987	34.925	34.925	26.988	3.6	3.2	231	319	45.8	2 200	2 900	<b>LM522546</b>	<b>LM522510</b>	32.9	122.0	116.0	146.0	154.0	3.6	3.2	0.40	1.50	0.82	1.64	0.784
	161.925	34.925	34.925	26.988	3.6	3.2	216	293	41.8	2 200	2 900	<b>48190</b>	<b>48120</b>	39.1	121.0	120.0	145.0	154.0	3.6	3.2	0.51	1.19	0.65	1.57	0.820
	165.100	36.512	36.512	26.988	3.6	3.2	245	325	46.3	2 200	2 900	<b>56425R</b>	<b>56650</b>	38.6	123.0	117.0	149.0	159.0	3.6	3.2	0.50	1.21	0.66	1.76	0.852
	168.275	36.512	36.512	26.988	3.6	3.2	245	325	46.3	2 200	2 900	<b>56425R</b>	<b>56662</b>	38.6	123.0	117.0	150.0	160.0	3.6	3.2	0.50	1.21	0.66	1.76	1.03
	190.500	47.625	49.212	34.925	3.6	3.2	381	483	60.9	1 900	2 600	<b>71425</b>	<b>71750</b>	40.9	121.0	131.0	167.0	177.0	3.6	3.2	0.42	1.44	0.79	3.76	1.72

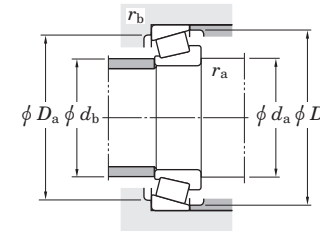
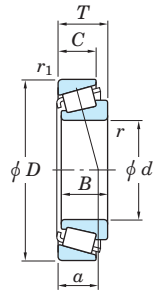
[Note] 1) To the bearings with supplementary code "J" attached at the front of bearing number, tolerances shown in table 7-8 on page A72 are applied.

[Remark] Inch series tapered roller bearings with bore diameter larger than 100 mm are shown in catalog "large size ball & roller bearings".



Single-row tapered roller bearings  
inch series

$d$  (107.950) ~ 127.000 mm



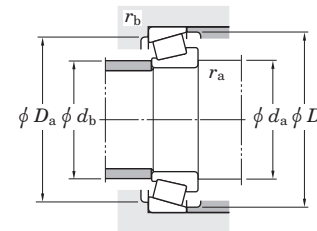
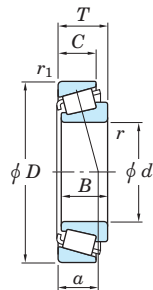
Boundary dimensions (mm)							Basic load ratings (kN)		Fatigue load limit (kN)	Limiting speeds (min <sup>-1</sup> )		Bearing No. <sup>1)</sup>	Load center (mm)	Mounting dimensions (mm)						Constant e	Axial load factors		(Refer.) Mass (kg)		
$d$	$D$	$T$	$B$	$C$	$r_{min.}$	$r_{1 min.}$	$C_r$	$C_{0r}$	$C_u$	Grease lub.	Oil lub.			Inner ring	Outer ring	$d_a$	$d_b$	$D_a$	$D_b$		$r_{a max.}$	$r_{b max.}$	$Y_1$	$Y_0$	Inner ring
<b>107.950</b>	212.725	66.675	66.675	53.975	7.9	3.2	563	674	84.1	1 800	2 400	<b>936</b> <b>HH224340</b>	<b>932</b> <b>HH224310</b>	47.6	137.0	122.0	187.0	193.0	7.9	3.2	0.33	1.84	1.01	6.52	4.07
	212.725	66.675	66.675	53.975	7.9	3.2	641	699	87.1	1 800	2 400			47.6	129.0	134.0	189.0	201.0	7.9	3.2	0.33	1.84	1.01	7.21	3.03
<b>109.538</b>	158.750	23.020	21.438	15.875	3.6	3.2	130	169	23.9	2 200	3 000	<b>37431</b>	<b>37625</b>	36.5	123.0	116.0	143.0	152.0	6.4	6.4	0.61	0.99	0.54	0.848	0.484
<b>109.987</b>	159.987	34.925	34.925	26.988	7.9	3.2	231	319	45.8	2 200	2 900	<b>LM522548</b> <b>LM522549</b>	<b>LM522510</b> <b>LM522510</b>	32.9	131.0	121.0	146.0	154.0	7.9	3.2	0.40	1.50	0.82	1.52	0.784
	159.987	34.925	34.925	26.988	3.6	3.2	231	319	45.8	2 200	2 900			32.9	123.0	121.0	146.0	154.0	3.6	3.2	0.40	1.50	0.82	1.55	0.784
<b>109.992</b>	177.800	41.275	41.275	30.162	3.6	3.2	294	380	53.4	2 000	2 700	<b>64433R</b>	<b>64700</b>	42.8	128.0	121.0	160.0	172.6	3.6	3.2	0.52	1.16	0.64	2.69	1.10
<b>110.000</b>	165.000	35.000	35.000	26.500	3.0	2.5	245	325	46.3	2 200	2 900	<b>JM822049</b> <b>JHM522649</b>	<b>JM822010</b> <b>JHM522610</b>	38.1	121.0	121.0	148.0	157.0	3.0	2.5	0.50	1.21	0.66	1.64	0.826
	180.000	47.000	46.000	38.000	3.0	2.5	385	487	62.3	2 000	2 700			40.6	121.0	125.0	160.0	171.0	3.0	2.5	0.41	1.48	0.81	3.08	1.49
<b>114.300</b>	177.800	41.275	41.275	30.162	3.6	3.2	294	380	53.4	2 000	2 700	<b>64450R</b> <b>68450</b> <b>71450</b>	<b>64700</b> <b>68712</b> <b>71750</b>	42.8	131.0	125.0	160.0	172.0	3.6	3.2	0.52	1.16	0.64	2.45	1.10
	180.975	34.925	31.750	25.400	3.6	3.2	216	247	35.1	2 000	2 700			40.6	127.0	131.0	161.0	170.0	3.6	3.2	0.50	1.21	0.66	1.89	1.04
	190.500	47.625	49.212	34.925	3.6	3.2	381	483	60.9	1 900	2 600			40.9	127.0	131.0	167.0	177.0	3.6	3.2	0.42	1.44	0.79	3.33	1.72
	212.725	66.675	66.675	53.975	7.1	3.2	563	674	84.1	1 800	2 400			47.6	141.0	128.0	187.0	193.0	7.1	3.2	0.33	1.84	1.01	5.96	4.07
	212.725	66.675	66.675	53.975	7.1	3.2	641	699	87.1	1 800	2 400			47.6	134.0	134.0	189.0	201.0	7.1	3.2	0.33	1.84	1.01	6.64	3.03
	273.050	82.550	82.550	53.975	6.4	6.4	885	898	104	1 500	1 900			76.1	133.0	151.0	230.0	252.0	6.4	6.4	0.63	0.95	0.52	15.0	6.97
<b>114.976</b>	212.725	66.675	66.675	53.975	7.1	3.2	641	699	87.1	1 800	2 400	<b>HH224349</b>	<b>HH224310</b>	47.6	135.0	134.0	189.0	201.0	7.1	3.2	0.33	1.84	1.01	6.58	3.03
<b>115.087</b>	190.500	47.625	49.212	34.925	3.6	3.2	381	483	60.9	1 900	2 600	<b>71453</b> <b>71455</b>	<b>71750</b> <b>71750</b>	40.9	133.0	126.0	171.0	181.0	3.6	3.2	0.42	1.44	0.79	3.28	1.72
	190.500	47.625	49.212	34.925	7.9	3.2	381	483	60.9	1 900	2 600			40.9	136.0	131.0	167.0	177.0	7.9	3.2	0.42	1.44	0.79	3.25	1.72
<b>117.475</b>	180.975	34.925	31.750	25.400	3.6	3.2	216	247	35.1	2 000	2 700	<b>68462</b> <b>68463</b>	<b>68712</b> <b>68712</b>	40.6	130.0	131.0	161.0	170.0	3.6	3.2	0.50	1.21	0.66	1.75	1.04
	180.975	34.925	31.750	25.400	7.9	3.2	216	247	35.1	2 000	2 700			40.6	141.0	125.0	163.0	172.0	7.9	3.2	0.50	1.21	0.66	1.61	1.05
<b>120.650</b>	190.500	46.038	46.038	34.925	3.6	1.6	393	512	63.9	1 900	2 500	<b>HM624749</b> <b>HH228340</b>	<b>HM624710</b> <b>HH228310</b>	41.6	146.0	132.0	174.0	184.0	3.6	1.6	0.43	1.41	0.77	3.20	1.44
	254.000	77.788	82.550	61.912	9.5	6.4	895	1 050	125	1 500	2 000			54.3	158.0	142.0	223.0	234.0	9.5	6.4	0.32	1.87	1.03	12.6	6.00
<b>127.000</b>	254.000	77.788	82.550	61.912	9.5	6.4	895	1 050	125	1 500	2 000	<b>HH228349</b>	<b>HH228310</b>	54.3	164.0	148.0	223.0	234.0	9.5	6.4	0.32	1.87	1.03	11.8	6.00

[Note] 1) To the bearings with supplementary code "J" attached at the front of bearing number, tolerances shown in table 7-8 on page A72 are applied.

[Remark] Inch series tapered roller bearings with bore diameter larger than 100 mm are shown in catalog "large size ball & roller bearings".

Single-row tapered roller bearings  
inch series

$d$  133.350 ~ 292.100 mm



Boundary dimensions (mm)							Basic load ratings (kN)		Fatigue load limit (kN)	Limiting speeds (min <sup>-1</sup> )		Bearing No. <sup>1)</sup>	Load center (mm)	Mounting dimensions (mm)						Constant e	Axial load factors		(Refer.) Mass (kg)		
$d$	$D$	$T$	$B$	$C$	$r_{min.}$	$r_{1 min.}$	$C_r$	$C_{0r}$	$C_u$	Grease lub.	Oil lub.			Inner ring	Outer ring	$d_a$	$d_b$	$D_a$	$D_b$		$r_{a max.}$	$r_{b max.}$	$Y_1$	$Y_0$	Inner ring
<b>133.350</b>	177.008	25.400	26.195	20.638	1.6	1.6	176	278	38.2	1 900	2 500	<b>L327249</b>	<b>L327210</b>	29.1	142.0	145.0	164.0	171.0	1.6	1.6	0.35	1.72	0.95	1.14	0.543
<b>142.875</b>	200.025	41.275	39.688	34.130	7.9	3.3	307	491	66.5	1 700	2 200	<b>48684</b>	<b>48620</b>	38.4	166.0	151.0	185.0	193.0	7.9	3.3	0.34	1.78	0.98	2.43	1.38
	200.025	41.275	39.688	34.130	3.6	3.3	307	491	66.5	1 700	2 200	<b>48685</b>	<b>48620</b>	38.4	156.0	157.0	182.0	192.0	3.6	3.3	0.34	1.78	0.98	2.46	1.38
<b>170.000</b>	230.000	39.000	38.000	31.000	3.0	2.5	363	558	72.8	1 400	1 900	<b>JHM534149</b>	<b>JHM534110</b>	43.6	181.0	184.0	214.0	222.0	3.0	2.5	0.38	1.57	0.86	3.17	1.29
	240.000	46.000	44.500	37.000	3.0	2.5	443	666	77.1	1 400	1 800	<b>JM734449</b>	<b>JM734410</b>	50.6	181.0	184.0	220.0	231.0	3.0	2.5	0.44	1.37	0.75	4.31	2.00
<b>171.450</b>	222.250	25.400	24.608	19.050	1.6	1.6	197	299	38.7	1 400	1 900	<b>L435049</b>	<b>L435010</b>	36.0	181.0	179.0	211.0	215.0	1.6	1.6	0.38	1.60	0.88	1.63	0.697
<b>180.000</b>	250.000	47.000	45.000	37.000	3.0	2.5	456	705	81.7	1 300	1 700	<b>JM736149</b>	<b>JM736110</b>	55.2	191.0	193.0	230.0	242.0	3.0	2.5	0.48	1.25	0.69	4.47	2.10
<b>190.000</b>	260.000	46.000	44.000	36.500	3.0	2.5	461	723	81.4	1 200	1 700	<b>JM738249</b>	<b>JM738210</b>	56.0	201.0	203.0	240.0	251.0	3.0	2.5	0.48	1.26	0.69	4.71	2.18
<b>196.850</b>	254.000	28.575	27.783	21.433	1.6	1.6	236	387	48.2	1 200	1 600	<b>L540049</b>	<b>L540010</b>	43.1	206.0	214.0	238.0	245.0	1.6	1.6	0.40	1.51	0.83	2.34	1.02
<b>200.000</b>	300.000	65.000	62.000	51.000	3.6	2.5	773	1 140	124	1 100	1 500	<b>JHM840449</b>	<b>JHM840410</b>	72.1	213.0	218.0	270.0	288.0	3.6	2.5	0.52	1.15	0.63	9.97	5.13
<b>220.878</b>	317.500	47.625	52.388	36.513	3.2	3.2	611	928	103	970	1 300	<b>LM245833</b>	<b>LM245810</b>	50.5	234.0	253.0	296.0	304.0	3.2	3.2	0.33	1.80	0.99	9.56	2.78
<b>228.600</b>	358.775	71.438	71.438	53.975	3.6	3.2	968	1 590	166	840	1 100	<b>M249732</b>	<b>M249710</b>	64.4	242.0	279.0	330.0	343.0	3.6	3.2	0.33	1.80	0.99	20.1	6.44
<b>230.188</b>	317.500	47.625	52.388	36.513	3.2	3.2	611	928	103	970	1 300	<b>LM245846</b>	<b>LM245810</b>	50.5	242.0	238.0	309.0	312.0	3.2	3.2	0.33	1.80	0.99	8.25	2.78
<b>231.775</b>	317.500	47.625	52.388	36.513	3.2	3.2	611	928	103	970	1 300	<b>LM245848</b>	<b>LM245810</b>	50.5	244.0	240.0	309.0	312.0	3.2	3.2	0.33	1.80	0.99	8.02	2.78
	336.550	65.088	65.088	50.800	6.4	3.2	887	1 380	150	920	1 200	<b>M246942</b>	<b>M246910</b>	59.9	258.0	249.0	313.0	322.0	6.4	3.2	0.33	1.80	0.99	13.1	5.44
	358.775	71.438	71.438	53.975	6.4	3.2	968	1 590	166	920	1 200	<b>M249734</b>	<b>M249710</b>	64.4	258.0	253.0	335.0	343.0	6.4	3.2	0.33	1.80	0.99	19.9	6.44
<b>254.000</b>	358.775	71.438	71.438	53.975	3.6	3.2	968	1 590	166	840	1 100	<b>M249749</b>	<b>M249710</b>	64.4	268.0	279.0	330.0	343.0	3.6	3.2	0.33	1.80	0.99	14.8	6.44
<b>257.175</b>	342.900	57.150	57.150	44.450	6.4	3.2	764	1 280	135	870	1 200	<b>M349549</b>	<b>M349510</b>	60.1	276.0	276.0	320.0	330.0	6.4	3.2	0.35	1.73	0.95	9.27	3.99
<b>292.100</b>	374.650	47.625	47.625	34.925	3.6	3.2	587	971	111	760	1 000	<b>L555249</b>	<b>L555210</b>	64.7	306.0	309.0	351.0	360.0	3.6	3.2	0.40	1.49	0.82	7.97	3.53

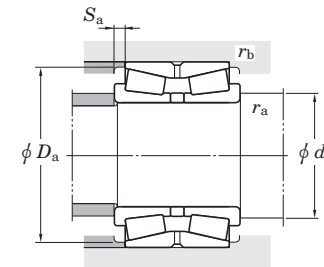
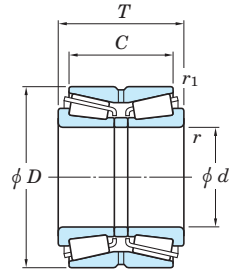
[Note] 1) To the bearings with supplementary code "J" attached at the front of bearing number, tolerances shown in table 7-8 on page A72 are applied.

[Remark] Inch series tapered roller bearings with bore diameter larger than 100 mm are shown in catalog "large size ball & roller bearings".

Double-row tapered roller bearings

TDO type

d 25 ~ (60) mm



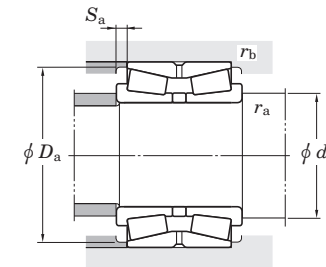
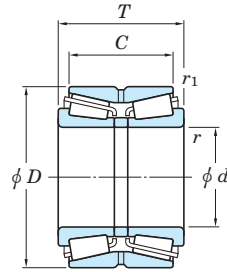
Boundary dimensions (mm)						Basic load ratings (kN)		Fatigue load limit	Limiting speeds (min <sup>-1</sup> )		Bearing No.	Mounting dimensions (mm)					Constant e	Axial load factors			(Refer.) Mass (kg)
d	D	T	C	r min.	r1 min.	Cr	Cor	(kN) Cu	Grease lub.	Oil lub.		da min.	Da min.	Sa min.	ra max.	rb max.		Y2	Y3	Y0	
25	62	40	29.5	1.5	0.6	85.2	84.9	5.80	4 500	6 400	46T30305DJR/29.5	33.5	58.5	5	1.5	0.6	0.83	0.82	1.22	0.8	0.592
30	72	45	31.5	1.5	0.6	109	110	7.70	3 900	5 400	46T30306DJR/31.5	38.5	68	6.5	1.5	0.6	0.83	0.82	1.22	0.8	0.872
35	80	51	35.5	2	0.6	135	138	9.85	3 400	4 800	46T30307DJR/35.5	45	76.5	7.5	2	0.6	0.83	0.82	1.22	0.8	1.2
40	80	45	37.5	1.5	0.6	134	138	10.3	4 000	5 300	46T30208JR/37.5	48.5	75	3.5	1.5	0.6	0.37	1.8	2.68	1.76	0.954
	80	55	43.5	1.5	0.6	166	182	13.6	4 000	5 300	46T32208JR/43.5	48.5	75	5.5	1.5	0.6	0.37	1.8	2.68	1.76	1.19
	90	56	39.5	2	0.6	172	180	13.1	3 000	4 200	46T30308DJR/39.5	50	86.5	8	2	0.6	0.83	0.82	1.22	0.8	1.67
	90	56	45.5	2	0.6	194	202	15.5	3 600	4 900	46T30308JR/45.5	50	82	5	2	0.6	0.35	1.96	2.91	1.91	1.67
45	85	47	37.5	1.5	0.6	144	155	11.6	3 700	4 900	46T30209JR/37.5	53.5	80	4.5	1.5	0.6	0.4	1.67	2.48	1.63	1.1
	85	55	43.5	1.5	0.6	180	207	15.6	3 700	4 900	46T32209JR-1/43.5	53.5	81	5.5	1.5	0.6	0.4	1.67	2.48	1.63	1.31
	100	60	41.5	2	0.6	204	214	15.8	2 700	3 800	46T30309DJR/41.5	55	96	9	2	0.6	0.83	0.82	1.22	0.8	2.15
	100	60	49.5	2	0.6	242	256	19.9	3 300	4 300	46T30309JR/49.5	55	93	5	2	0.6	0.35	1.96	2.91	1.91	2.2
50	90	49	39.5	1.5	0.6	164	183	13.8	3 400	4 600	46T30210JR/39.5	58.5	85	4.5	1.5	0.6	0.42	1.61	2.39	1.57	1.22
	90	55	43.5	1.5	0.6	182	211	15.9	3 500	4 600	46T32210JR/43.5	58.5	85	5.5	1.5	0.6	0.42	1.61	2.39	1.57	1.39
	110	64	51.5	2	0.6	295	305	24.0	3 000	4 000	46T30310JR/51.5	62	102	6	2	0.6	0.35	1.96	2.91	1.91	2.68
	110	73	52.5	2	0.6	247	266	19.8	2 500	3 500	46T30310DJR/52.5	62	105	10	2	0.6	0.83	0.82	1.22	0.8	3.11
	110	90	71.5	2	0.6	378	440	34.2	3 000	4 000	46T32310JR/71.5	62	102	9	2	0.6	0.35	1.96	2.91	1.91	3.95
55	100	51	41.5	2	0.6	203	226	17.3	3 100	4 100	46T30211JR/41.5	65	94	4.5	2	0.6	0.4	1.67	2.48	1.63	1.6
	100	60	48.5	2	0.6	230	266	20.5	3 100	4 100	46T32211JR-1/48.5	65	95	5.5	2	0.6	0.4	1.67	2.48	1.63	1.87
	120	70	49	2	0.6	276	297	22.3	2 300	3 200	46T30311DJR/49	67	113	10.5	2	0.6	0.83	0.82	1.22	0.8	3.54
	120	70	57	2	0.6	320	341	27.0	2 700	3 600	46T30311JR/57	67	111	6.5	2	0.6	0.35	1.96	2.91	1.91	3.57
	120	97	76	2	0.6	429	500	39.1	2 700	3 600	46T32311JR/76	67	111	10.5	2	0.6	0.35	1.96	2.91	1.91	4.98
60	110	53	43.5	2	0.6	228	254	19.7	2 800	3 800	46T30212JR/43.5	70	103	4.5	2	0.6	0.4	1.67	2.48	1.63	2.04
	110	66	54.5	2	0.6	282	334	25.9	2 800	3 800	46T32212JR/54.5	70	104	5.5	2	0.6	0.4	1.67	2.48	1.63	—
	130	74	51	2.5	1	327	359	27.1	2 100	2 900	46T30312DJR/51	74	124	11.5	2.5	1	0.83	0.82	1.22	0.8	4.45
	130	74	59	2.5	1	372	401	31.9	2 500	3 300	46T30312JR/59	74	120	7.5	2.5	1	0.35	1.96	2.91	1.91	4.46

[Remark] Bearings not shown above (e.g. inch series) are shown in catalog "large size ball & roller bearings".

Double-row tapered roller bearings

TDO type

$d$  (60) ~ (90) mm



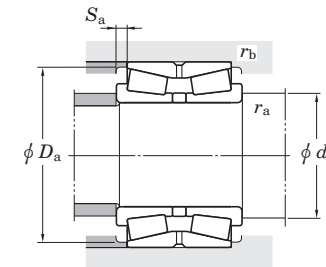
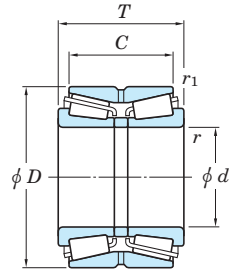
Boundary dimensions (mm)						Basic load ratings (kN)		Fatigue load limit	Limiting speeds (min <sup>-1</sup> )		Bearing No.	Mounting dimensions (mm)					Con-stant	Axial load factors			(Refer.) Mass (kg)	
$d$	$D$	$T$	$C$	$r_{min.}$	$r_{1 min.}$	$C_r$	$C_{Or}$	(kN) $C_u$	Grease lub.	Oil lub.		$d_a$ min.	$D_a$ min.	$S_a$ min.	$r_a$ max.	$r_b$ max.	$e$	$Y_2$	$Y_3$	$Y_0$		
60	130	104	81	2.5	1	524	629	44.1	2 500	3 300		<b>46T32312JR/81</b>	74	120	11.5	2.5	1	0.35	1.96	2.91	1.91	6.45
65	120	56	46.5	2	0.6	275	311	24.3	2 600	3 400		<b>46T30213JR/46.5</b>	75	113	4.5	2	0.6	0.4	1.67	2.48	1.63	—
	120	73	61.5	2	0.6	337	406	31.7	2 600	3 400		<b>46T32213JR/61.5</b>	75	115	5.5	2	0.6	0.4	1.67	2.48	1.63	3.4
	140	79	53	2.5	1	377	417	31.4	1 900	2 700		<b>46T30313DJR/53</b>	79	133	13	2.5	1	0.83	0.82	1.22	0.8	5.3
	140	79	63	2.5	1	437	478	37.6	2 300	3 000		<b>46T30313JR/63</b>	79	130	8	2.5	1	0.35	1.96	2.91	1.91	5.51
	140	108	84	2.5	1	593	714	49.6	2 300	3 100		<b>46T32313JR/84</b>	79	130	12	2.5	1	0.35	1.96	2.91	1.91	7.71
70	125	59	48.5	2	0.6	296	346	27.1	2 400	3 300		<b>46T30214JR/48.5</b>	80	118	5	2	0.6	0.42	1.61	2.39	1.57	—
	125	74	61.5	2	0.6	363	450	35.2	2 400	3 300		<b>46T32214JR/61.5</b>	80	119	6	2	0.6	0.42	1.61	2.39	1.57	3.7
	150	83	57	2.5	1	421	470	34.9	1 800	2 500		<b>46T30314DJR/57</b>	84	142	13	2.5	1	0.83	0.82	1.22	0.8	6.48
	150	83	67	2.5	1	493	546	42.2	2 100	2 800		<b>46T30314JR/67</b>	84	140	8	2.5	1	0.35	1.96	2.91	1.91	6.65
	150	116	92	2.5	1	679	829	57.2	2 200	2 900		<b>46T32314JR/92</b>	84	140	12	2.5	1	0.35	1.96	2.91	1.91	9.46
75	115	30	26	1.5	0.6	89.9	105	7.30	2 500	3 300		<b>46215</b>	83.5	106.5	2	1.5	0.6	0.32	2.12	3.15	2.07	0.994
	115	38	30	1.5	0.6	153	207	15.6	2 500	3 300		<b>46215A</b>	83.5	107.4	4	1.5	0.6	0.32	2.12	3.15	2.07	1.32
	130	62	51.5	2	0.6	305	362	28.2	2 300	3 100		<b>46T30215JR/51.5</b>	85	124	5	2	0.6	0.44	1.55	2.31	1.52	3.12
	130	74	61.5	2	0.6	373	469	36.4	2 300	3 100		<b>46T32215JR/61.5</b>	85	125	6	2	0.6	0.44	1.55	2.31	1.52	3.85
	160	87	69	2.5	1	557	621	44.9	2 000	2 600		<b>46T30315JR/69</b>	89	149	9	2.5	1	0.35	1.96	2.91	1.91	7.8
	160	125	99	2.5	1	779	963	64.6	2 000	2 700		<b>46T32315JR/99</b>	89	149	13	2.5	1	0.35	1.96	2.91	1.91	11.5
80	125	34	30	1.5	0.6	136	155	11.3	2 300	3 100		<b>46216</b>	88.5	116.9	2	1.5	0.6	0.35	1.95	2.90	1.91	1.38
	140	64	51.5	2	0.6	346	405	31.2	2 200	2 900		<b>46T30216JR/51.5</b>	92	132	6	2	0.6	0.42	1.61	2.39	1.57	3.76
	140	78	63.5	2	0.6	434	542	41.5	2 200	2 900		<b>46T32216JR/63.5</b>	92	134	7	2	0.6	0.42	1.61	2.39	1.57	4.71
	170	92	73	2.5	1	630	711	49.9	1 800	2 500		<b>46T30316JR/73</b>	94	159	9.5	2.5	1	0.35	1.96	2.91	1.91	9.44
85	150	70	57	2	0.6	391	463	35.1	2 000	2 700		<b>46T30217JR/57</b>	97	141	6.5	2	0.6	0.42	1.61	2.39	1.57	4.79
	150	86	69	2	0.6	498	630	47.5	2 000	2 700		<b>46T32217JR/69</b>	97	142	8.5	2	0.6	0.42	1.61	2.39	1.57	6.05
	180	98	77	3	1	679	768	53.0	1 700	2 300		<b>46T30317JR/77</b>	103	167	10.5	3	1	0.35	1.96	2.91	1.91	11
	180	137	108	3	1	941	1 170	77.6	1 800	2 400		<b>46T32317JR/108</b>	103	167	14.5	3	1	0.35	1.96	2.91	1.91	16
90	140	37	33	2	0.6	171	199	14.4	2 100	2 800		<b>46218</b>	100	130.6	2	2	0.6	0.35	1.95	2.90	1.91	1.89

[Remark] Bearings not shown above (e.g. inch series) are shown in catalog "large size ball & roller bearings".

Double-row tapered roller bearings

TDO type

d (90) ~ 110 mm



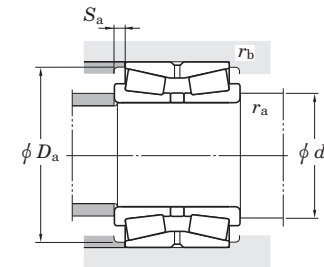
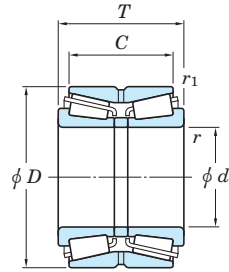
Boundary dimensions (mm)						Basic load ratings (kN)		Fatigue load limit (kN) C <sub>u</sub>	Limiting speeds (min <sup>-1</sup> )		Bearing No.	Mounting dimensions (mm)					Con-stant e	Axial load factors			(Refer.) Mass (kg)
d	D	T	C	r min.	r <sub>1</sub> min.	C <sub>r</sub>	C <sub>0r</sub>		Grease lub.	Oil lub.		d <sub>a</sub> min.	D <sub>a</sub> min.	S <sub>a</sub> min.	r <sub>a</sub> max.	r <sub>b</sub> max.		Y <sub>2</sub>	Y <sub>3</sub>	Y <sub>0</sub>	
<b>90</b>	140	46	37	2	0.6	196	266	19.6	2 000	2 700	<b>46218A</b> <b>46T30218JR/61</b> <b>46T32218JR/77</b> <b>46T30318JR/81</b> <b>46T32318JR/115</b>	100	129.9	4.5	2	0.6	0.32	2.12	3.15	2.07	2.37
	160	74	61	2	0.6	438	522	39.0	1 900	2 500		102	150	6.5	2	0.6	0.42	1.61	2.39	1.57	5.85
	160	94	77	2	0.6	565	724	53.7	1 900	2 500		102	152	8.5	2	0.6	0.42	1.61	2.39	1.57	7.53
	190	102	81	3	1	741	841	57.1	1 600	2 200		108	177	10.5	3	1	0.35	1.96	2.91	1.91	13
	190	144	115	3	1	989	1 230	78.7	1 700	2 200		108	177	14.5	3	1	0.35	1.96	2.91	1.91	18.6
<b>95</b>	170	78	63	2.5	1	496	598	44.0	1 800	2 400	<b>46T30219JR/63</b> <b>46T32219JR/83</b> <b>46T30319JR/85</b> <b>46T32319JR/118</b>	109	159	7.5	2.5	1	0.42	1.61	2.39	1.57	7.01
	170	100	83	2.5	1	667	877	64.1	1 800	2 400		109	161	8.5	2.5	1	0.42	1.61	2.39	1.57	9.25
	200	108	85	3	1	798	909	60.9	1 600	2 100		113	186	11.5	3	1	0.35	1.96	2.91	1.91	14.8
	200	151	118	3	1	1 110	1 390	89.2	1 600	2 100		113	186	16.5	3	1	0.35	1.96	2.91	1.91	21.4
<b>100</b>	150	46	37	2	0.6	226	293	21.3	1 900	2 500	<b>46220A</b> <b>46320</b> <b>46320A</b> <b>46T30220JR/67</b> <b>46T32220JR/87</b> <b>46T30320JR/87</b> <b>46T32320JR/127</b>	110	142	4.5	2	0.6	0.35	1.95	2.90	1.91	2.53
	165	52	46	2.5	0.6	249	305	22.0	1 700	2 300		112	154	3	2	0.6	0.35	1.95	2.90	1.91	4.03
	165	65	52	2.5	0.6	333	443	32.4	1 800	2 300		112	153	6.5	2	0.6	0.35	1.95	2.90	1.91	4.97
	180	83	67	2.5	1	554	676	49.1	1 700	2 200		114	168	8	2.5	1	0.42	1.61	2.39	1.57	8.33
	180	107	87	2.5	1	745	990	63.9	1 700	2 200		114	171	10	2.5	1	0.42	1.61	2.39	1.57	11.1
	215	112	87	3	1	906	1 040	68.0	1 500	1 900		118	200	12.5	3	1	0.35	1.96	2.91	1.91	18.1
	215	162	127	3	1	1 240	1 570	96.9	1 500	2 000		118	200	17.5	3	1	0.35	1.96	2.91	1.91	27.2
<b>105</b>	190	88	70	2.5	1	618	761	52.3	1 600	2 100	<b>46T30221JR/70</b> <b>46T32221JR/95</b> <b>46T30321JR/91</b> <b>46T32321JR/133</b>	119	178	9	2.5	1	0.42	1.61	2.39	1.57	9.87
	190	115	95	2.5	1	840	1 130	73.0	1 600	2 100		119	180	10	2.5	1	0.42	1.61	2.39	1.57	13.5
	225	116	91	3	1	995	1 160	73.6	1 400	1 800		123	209	12.5	3	1	0.35	1.96	2.91	1.91	20.7
	225	170	133	3	1	1 360	1 730	107	1 400	1 900		123	209	18.5	3	1	0.35	1.96	2.91	1.91	30.9
<b>110</b>	170	45	40	2.5	0.6	219	304	21.2	1 700	2 200	<b>46222</b> <b>46322</b> <b>46322A</b> <b>46T30222JR/74</b> <b>46T32222JR/101</b> <b>46T30322JR/93</b> <b>46T32322JR/142</b>	122	158	2.5	2	0.6	0.35	1.95	2.90	1.91	3.58
	180	56	50	2.5	0.6	308	388	27.7	1 600	2 100		122	168	3	2	0.6	0.35	1.95	2.90	1.91	5.13
	180	70	56	2.5	0.6	391	533	38.1	1 600	2 100		122	168	7	2	0.6	0.35	1.92	2.86	1.88	6.43
	200	92	74	2.5	1	695	868	58.1	1 500	2 000		124	188	9	2.5	1	0.42	1.61	2.39	1.57	11.6
	200	121	101	2.5	1	938	1 280	80.4	1 500	2 000		124	190	10	2.5	1	0.42	1.61	2.39	1.57	15.9
	240	118	93	3	1	1 030	1 180	75.2	1 300	1 700		128	222	12.5	3	1	0.35	1.96	2.91	1.91	23.8
	240	181	142	3	1	1 480	1 890	115	1 300	1 700		128	222	19.5	3	1	0.35	1.96	2.91	1.91	37.3

[Remark] Bearings not shown above (e.g. inch series) are shown in catalog "large size ball & roller bearings".

Double-row tapered roller bearings

TDO type

d 120 ~ (150) mm

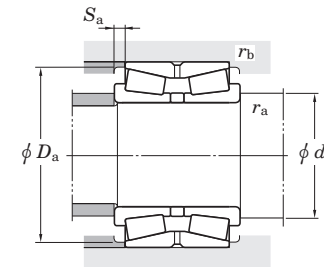
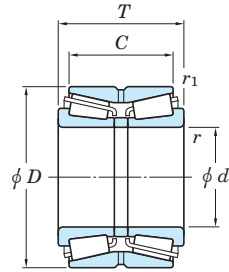


Boundary dimensions (mm)						Basic load ratings (kN)		Fatigue load limit	Limiting speeds (min <sup>-1</sup> )		Bearing No.	Mounting dimensions (mm)					Con-stant	Axial load factors			(Refer.) Mass (kg)
d	D	T	C	r min.	r1 min.	Cr	Cor	(kN) Cu	Grease lub.	Oil lub.		da min.	Da min.	Sa min.	ra max.	rb max.	e	Y2	Y3	Y0	
120	180	46	41	2.5	0.6	232	317	21.8	1 500	2 000	46224 46224A 46324 46324A 46324AS 46T30224JR/78 46T32224JR/109 46T30324JR/101 46T32324JR/145	132	170	2.5	2	0.6	0.35	1.95	2.90	1.91	3.81
	180	58	46	2.5	0.6	309	460	32.2	1 500	2 100		132	169	6	2	0.6	0.35	1.95	2.90	1.91	4.66
	200	62	55	2.5	0.6	367	470	32.8	1 400	1 900		132	184	3.5	2	0.6	0.35	1.95	2.90	1.91	7.28
	200	78	62	2.5	0.6	486	672	47.0	1 400	1 900		132	185	8	2	0.6	0.35	1.95	2.90	1.91	9.14
	200	100	84	2.5	0.6	670	1 010	62.5	1 400	1 900		132	190	8	2	0.6	0.35	1.95	2.90	1.91	12.0
	215	97	78	2.5	1	745	945	61.7	1 400	1 800		134	203	9.5	2.5	1	0.44	1.55	2.31	1.52	13.9
	215	132	109	2.5	1	1 010	1 380	84.0	1 400	1 900		134	204	11.5	2.5	1	0.44	1.55	2.31	1.52	19.8
	260	128	101	3	1	1 220	1 430	89.9	1 200	1 600		138	239	13.5	3	1	0.35	1.96	2.91	1.91	30.6
	260	188	145	4	1.5	1 720	2 210	131	1 200	1 600		142	239	21.5	4	1.5	0.35	1.96	2.91	1.91	45.9
130	200	52	46	2.5	0.6	299	425	28.9	1 400	1 800	46226 46226A 46326 46326A 46T30226JR/78.5 46T32226JR/117.5 46T30326JR/107.5	142	187	3	2	0.6	0.35	1.95	2.90	1.91	5.57
	200	65	52	2.5	0.6	400	618	42.5	1 400	1 900		142	185	6.5	2	0.6	0.35	1.95	2.90	1.91	7.06
	210	64	57	2.5	0.6	404	535	36.8	1 400	1 800		142	196	3.5	2	0.6	0.36	1.87	2.79	1.83	7.81
	210	80	64	2.5	0.6	513	723	49.7	1 300	1 800		142	198	8	2	0.6	0.36	1.87	2.79	1.83	9.57
	230	98	78.5	3	1	809	1 020	65.7	1 300	1 700		148	218	9.5	3	1	0.44	1.55	2.31	1.52	15.7
	230	145	117.5	3	1	1 190	1 660	99.9	1 300	1 700		148	219	14	3	1	0.44	1.55	2.31	1.52	24.1
	280	137	107.5	4	1.5	1 410	1 670	102	1 100	1 400		152	255	15	4	1.5	0.35	1.96	2.91	1.91	38.1
	140	210	53	47	2.5	0.6	299	404	27.3	1 300		1 800	46228 46228A 46328 46328A 46T30228JR/82.5 46T32228JR/125.5 46T30328JR/115.5	152	196	3	2	0.6	0.33	2.03	3.02
210		66	53	2.5	0.6	452	639	43.4	1 300	1 800	152	199		6.5	2	0.6	0.47	1.43	2.12	1.40	7.18
225		68	61	3	1	423	564	38.1	1 200	1 700	154	210		3.5	2.5	1	0.35	1.95	2.90	1.91	9.56
225		85	68	3	1	597	836	56.6	1 200	1 700	154	212		8	2.5	1	0.35	1.95	2.90	1.91	11.8
250		102	82.5	3	1	902	1 140	71.8	1 200	1 500	158	237		9.5	3	1	0.44	1.55	2.31	1.52	19.7
250		153	125.5	3	1	1 360	1 920	112	1 200	1 600	158	238		14	3	1	0.44	1.55	2.31	1.52	30.2
300		145	115.5	4	1.5	1 610	1 920	114	1 000	1 300	162	273		15	4	1.5	0.35	1.96	2.91	1.91	46.6
150		225	56	50	3	1	348	476	31.6	1 200	1 600	46230 46230A 46330 46330A 46T30230JR/87		164	213	3	2.5	1	0.33	2.03	3.02
	225	70	56	3	1	472	703	47.0	1 200	1 600	164		213	7	2.5	1	0.33	2.03	3.02	1.98	8.82
	250	80	71	3	1	587	786	49.2	1 100	1 500	164		233	4.5	2.5	1	0.35	1.95	2.90	1.91	14.6
	250	100	80	3	1	748	1 070	66.2	1 100	1 500	164		234	10	2.5	1	0.35	1.95	2.90	1.91	17.6
	270	109	87	3	1	1 040	1 330	80.9	1 100	1 400	168		255	11	3	1	0.44	1.55	2.31	1.52	24.6

[Remark] Bearings not shown above (e.g. inch series) are shown in catalog "large size ball & roller bearings".

Double-row tapered roller bearings  
TDO type

$d$  (150) ~ (200) mm

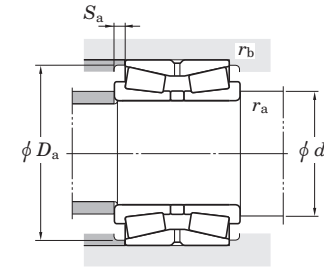
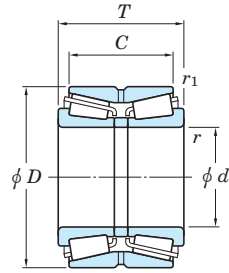


Boundary dimensions (mm)						Basic load ratings (kN)		Fatigue load limit (kN)	Limiting speeds (min <sup>-1</sup> )		Bearing No.	Mounting dimensions (mm)					Constant	Axial load factors			(Refer.) Mass (kg)
$d$	$D$	$T$	$C$	$r_{min.}$	$r_{1 min.}$	$C_r$	$C_{Or}$	$C_u$	Grease lub.	Oil lub.		$d_a$ min.	$D_a$ min.	$S_a$ min.	$r_a$ max.	$r_b$ max.	$e$	$Y_2$	$Y_3$	$Y_0$	
150	270	164	130	3	1	1 510	2 130	122	1 100	1 400	46T32230JR/130 46T30330JR/120	168	254	17	3	1	0.44	1.55	2.31	1.52	38
	320	154	120	4	1.5	1 800	2 160	129	930	1 200		172	292	17	4	1.5	0.35	1.96	2.91	1.91	56
160	240	60	53	3	1	405	565	37.0	1 100	1 500	46232 46232A 46332 46332A 46T30232JR/91 46T32232JR/144	174	228	3.5	2.5	1	0.33	2.03	3.02	1.98	8.71
	240	75	60	3	1	508	756	49.8	1 100	1 500		174	226	7.5	2.5	1	0.33	2.03	3.02	1.98	10.6
	270	86	76	3	1	695	950	57.5	1 000	1 400		174	252	5	2.5	1	0.35	1.95	2.90	1.91	18.8
	270	108	86	3	1	871	1 270	75.1	1 000	1 400		174	252	11	2.5	1	0.35	1.95	2.90	1.91	23.1
	290	115	91	3	1	1 160	1 500	89.3	980	1 300		178	269	12	3	1	0.44	1.55	2.31	1.52	29.9
	290	178	144	3	1	1 700	2 420	137	1 000	1 300		178	274	17	3	1	0.44	1.55	2.31	1.52	47.6
170	260	67	60	3	1	480	642	41.7	1 000	1 400	46234 46234A 46334 46334A 46T30234JR/97 46T32234JR/152	184	243	3.5	2.5	1	0.33	2.03	3.02	1.98	11.4
	260	84	67	3	1	629	969	62.6	1 000	1 400		184	244	8.5	2.5	1	0.33	2.03	3.02	1.98	14.7
	280	88	78	3	1	754	1 050	62.5	970	1 300		184	263	5	2.5	1	0.33	2.06	3.06	2.01	19.8
	280	110	88	3	1	938	1 390	81.5	980	1 300		184	260	11	2.5	1	0.33	2.06	3.06	2.01	24.7
	310	125	97	4	1.5	1 330	1 730	103	900	1 200		192	288	14	4	1.5	0.44	1.55	2.31	1.52	37.5
	310	192	152	4	1.5	1 930	2 760	152	910	1 200		192	294	20	4	1.5	0.44	1.55	2.31	1.52	58.8
180	280	74	66	3	1	582	801	49.4	950	1 300	46236 46236A 46336 46336A 46T30236JR/99 46T32236JR/152	194	263	4	2.5	1	0.33	2.03	3.02	1.98	15.5
	280	93	74	3	1	732	1 080	65.6	960	1 300		194	261	9.5	2.5	1	0.33	2.03	3.02	1.98	19.0
	300	96	85	4	1.5	872	1 240	74.5	910	1 200		198	277	5.5	3	1.5	0.33	2.06	3.06	2.01	25.8
	300	120	96	4	1.5	1 080	1 630	95.1	900	1 200		198	279	12	3	1.5	0.33	2.06	3.06	2.01	31.3
	320	127	99	4	1.5	1 320	1 740	102	860	1 200		202	297	14	4	1.5	0.45	1.5	2.23	1.47	40.1
	320	192	152	4	1.5	2 060	3 030	164	880	1 200		202	303	20	4	1.5	0.45	1.5	2.23	1.47	62.5
190	290	75	67	3	1	610	866	52.9	910	1 200	46238 46238A 46338 46338A 46T30238JR/105 46T32238JR/160	204	272	4	2.5	1	0.32	2.12	3.15	2.07	16.5
	290	94	75	3	1	793	1 170	70.2	900	1 200		204	274	9.5	2.5	1	0.33	2.03	3.02	1.98	20.0
	320	104	92	4	1.5	1 020	1 450	84.1	830	1 100		208	298	6	3	1.5	0.35	1.95	2.90	1.91	31.9
	320	130	104	4	1.5	1 230	1 860	106	840	1 100		208	298	13	3	1.5	0.35	1.95	2.90	1.91	39.0
	340	133	105	4	1.5	1 560	2 060	118	800	1 100		212	318	14	4	1.5	0.44	1.55	2.31	1.52	47.8
	340	204	160	4	1.5	2 340	3 480	187	810	1 100		212	323	22	4	1.5	0.44	1.55	2.31	1.52	75.1
200	310	82	73	3	1	716	1 040	61.6	850	1 100	46240	214	288	4.5	2.5	1	0.32	2.12	3.15	2.07	21.4

[Remark] Bearings not shown above (e.g. inch series) are shown in catalog "large size ball & roller bearings".

Double-row tapered roller bearings  
TDO type

$d$  (200) ~ (300) mm



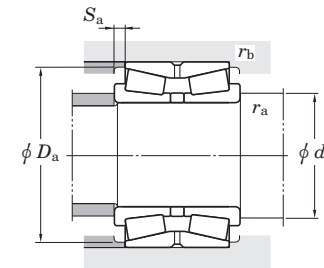
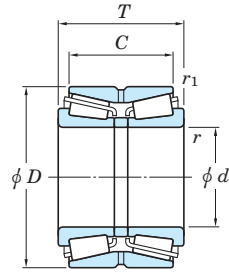
Boundary dimensions (mm)						Basic load ratings (kN)		Fatigue load limit (kN) $C_u$	Limiting speeds ( $\text{min}^{-1}$ )		Bearing No.	Mounting dimensions (mm)					Constant $e$	Axial load factors			(Refer.) Mass (kg)
$d$	$D$	$T$	$C$	$r_{\text{min.}}$	$r_{1\text{ min.}}$	$C_r$	$C_{0r}$		Grease lub.	Oil lub.		$d_a$ min.	$D_a$ min.	$S_a$ min.	$r_a$ max.	$r_b$ max.		$Y_2$	$Y_3$	$Y_0$	
200	310	103	82	3	1	893	1 380	80.2	840	1 100	46240A 46340 46340A 46T30240JR/110 46T32240JR/174	214	289	10.5	2.5	1	0.32	2.12	3.15	2.07	26.3
	340	112	100	4	1.5	1 100	1 580	90.2	780	1 000		218	316	6	3	1.5	0.35	1.95	2.90	1.91	39.6
	340	140	112	4	1.5	1 350	2 040	113	770	1 000		218	319	14	3	1.5	0.35	1.95	2.90	1.91	48.2
	360	142	110	4	1.5	1 700	2 240	126	750	1 000		222	336	16	4	1.5	0.44	1.55	2.31	1.52	56.5
	360	218	174	4	1.5	2 660	3 760	200	770	1 000		222	340	22	4	1.5	0.41	1.66	2.47	1.62	88.2
220	340	90	80	4	1.5	849	1 240	71.0	750	990	46244 46244A 46344 46344A 46T30244JR/114	238	319	5	3	1.5	0.32	2.12	3.15	2.07	27.8
	340	113	90	4	1.5	1 040	1 620	91.5	750	1 000		238	318	11.5	3	1.5	0.32	2.12	3.15	2.07	34.2
	370	120	107	5	1.5	1 260	1 810	101	700	930		242	346	6.5	4	1.5	0.35	1.95	2.90	1.91	49.1
	370	150	120	5	1.5	1 600	2 470	136	710	940		242	343	15	4	1.5	0.35	1.95	2.90	1.91	60.1
	400	150	114	4	1.5	2 170	2 880	160	660	890		242	371	18	4	1.5	0.42	1.61	2.39	1.57	75.8
240	360	92	82	4	1.5	962	1 430	79.7	690	920	46248 46248A 46348 46348A	258	338	5	3	1.5	0.32	2.12	3.15	2.07	29.6
	360	115	92	4	1.5	1 240	1 980	108	690	920		258	341	11.5	3	1.5	0.32	2.12	3.15	2.07	36.9
	400	128	114	5	1.5	1 490	2 180	121	630	840		262	377	7	4	1.5	0.35	1.95	2.90	1.91	59.0
	400	160	128	5	1.5	1 940	3 060	162	630	850		262	373	16	4	1.5	0.35	1.95	2.90	1.91	76.2
260	400	104	92	5	1.5	1 170	1 830	100	610	820	46252 46252A 46352 46352A	282	373	6	4	1.5	0.33	2.03	3.02	1.98	44.6
	400	130	104	5	1.5	1 520	2 480	133	610	810		282	376	13	4	1.5	0.32	2.12	3.15	2.07	54.8
	440	144	128	5	1.5	1 900	2 880	151	560	750		282	410	8	4	1.5	0.35	1.95	2.90	1.91	83.8
	440	180	144	5	1.5	2 430	3 960	204	570	760		282	409	18	4	1.5	0.35	1.95	2.90	1.91	105
280	420	106	94	5	1.5	1 260	1 970	106	570	760	46256 46256A 46356 46356A	302	395	6	4	1.5	0.33	2.03	3.02	1.98	46.9
	420	133	106	5	1.5	1 570	2 610	139	570	760		302	394	13.5	4	1.5	0.33	2.03	3.02	1.98	58.9
	460	146	130	6	2	1 950	2 930	154	530	700		308	430	8	5	2	0.35	1.95	2.90	1.91	90.0
	460	183	146	6	2	2 470	3 940	203	520	690		308	434	18.5	5	2	0.35	1.95	2.90	1.91	111
300	460	118	105	5	1.5	1 630	2 400	127	500	670	46260 46260A 46360 46360A	322	436	6.5	4	1.5	0.32	2.12	3.15	2.07	64.6
	460	148	118	5	1.5	2 050	3 230	165	510	680		322	433	15	4	1.5	0.32	2.12	3.15	2.07	80.2
	500	160	142	6	2	2 320	3 540	183	470	620		328	469	9	5	2	0.35	1.95	2.90	1.91	116
	500	200	160	6	2	2 860	4 630	231	470	630		328	466	20	5	2	0.35	1.95	2.90	1.91	144

[Remark] Bearings not shown above (e.g. inch series) are shown in catalog "large size ball & roller bearings".



Double-row tapered roller bearings  
TDO type

$d$  (300) ~420 mm

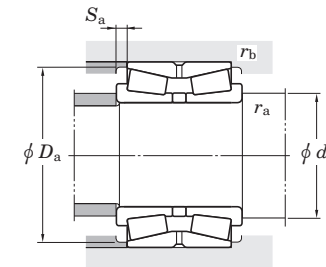
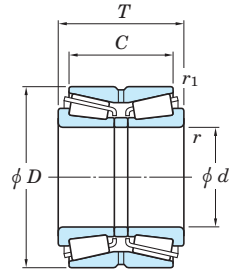


Boundary dimensions (mm)						Basic load ratings (kN)		Fatigue load limit (kN) $C_u$	Limiting speeds ( $\text{min}^{-1}$ )		Bearing No.	Mounting dimensions (mm)					Constant $e$	Axial load factors			(Refer.) Mass (kg)
$d$	$D$	$T$	$C$	$r_{\text{min.}}$	$r_{1 \text{ min.}}$	$C_r$	$C_{0r}$		Grease lub.	Oil lub.		$d_a$ min.	$D_a$ min.	$S_a$ min.	$r_a$ max.	$r_b$ max.		$Y_2$	$Y_3$	$Y_0$	
<b>300</b>	500	200	160	6	1.5	3 140	4 650	237	—	—	<b>46360D</b>	328	475	20	5	1.5	0.40	1.68	2.50	1.64	139
<b>320</b>	480	121	108	5	1.5	1 800	2 700	142	480	640	<b>46264</b>	342	452	6.5	4	1.5	0.32	2.12	3.15	2.07	71.6
	480	151	121	5	1.5	2 060	3 410	171	470	630	<b>46264A</b>	342	454	15	4	1.5	0.32	2.12	3.15	2.07	87.7
	540	176	157	6	2	2 880	4 570	228	420	560	<b>46364</b>	348	502	9.5	5	2	0.35	1.95	2.90	1.91	154
	540	220	176	6	2	3 280	5 390	264	430	570	<b>46364A</b>	348	497	22	5	2	0.35	1.95	2.90	1.91	190
<b>340</b>	520	133	118	6	2	1 940	3 070	157	420	570	<b>46268</b>	368	489	7.5	5	2	0.32	2.12	3.15	2.07	95.3
	520	165	133	6	2	2 420	4 060	203	420	560	<b>46268A</b>	368	491	16	5	2	0.32	2.12	3.15	2.07	117
	580	190	169	6	2	2 980	4 620	227	380	510	<b>46368</b>	368	539	10.5	5	2	0.35	1.95	2.90	1.91	198
	580	238	190	6	2	3 820	6 340	303	370	500	<b>46368A</b>	368	543	24	5	2	0.35	1.95	2.90	1.91	244
<b>360</b>	540	134	120	6	2	2 070	3 290	166	400	530	<b>46272</b>	388	510	7	5	2	0.32	2.12	3.15	2.07	93.0
	540	169	134	6	2	2 530	4 230	210	390	530	<b>46272A</b>	388	512	17.5	5	2	0.32	2.12	3.15	2.07	124
	600	192	171	6	2	3 600	4 880	264	360	480	<b>46372</b>	388	557	10.5	5	2	0.35	1.95	2.90	1.91	206
	600	240	192	6	2	4 590	7 230	345	360	480	<b>46372A</b>	388	568	24	5	2	0.39	1.74	2.59	1.70	254
<b>380</b>	560	135	122	6	2	2 190	3 560	177	370	500	<b>46276</b>	408	530	6.5	5	2	0.32	2.12	3.15	2.07	100
	560	171	135	6	2	2 810	4 670	228	380	500	<b>46276A</b>	408	531	18	5	2	0.39	1.74	2.59	1.70	129
	620	194	173	6	2	3 380	5 220	250	340	450	<b>46376</b>	408	582	10.5	5	2	0.39	1.74	2.59	1.70	215
	620	243	194	6	2	4 390	7 360	342	330	440	<b>46376A</b>	408	587	24.5	5	2	0.35	1.95	2.90	1.91	265
<b>400</b>	600	148	132	6	2	2 350	3 720	183	340	460	<b>46280</b>	428	560	8	5	2	0.32	2.12	3.15	2.07	135
	600	185	148	6	2	3 030	5 150	245	340	460	<b>46280A</b>	428	563	18.5	5	2	0.32	2.12	3.15	2.07	167
	650	200	178	6	3	3 740	5 920	283	320	420	<b>46380</b>	428	605	11	5	2.5	0.35	1.95	2.90	1.91	243
	650	250	200	6	3	5 110	8 850	406	310	420	<b>46380A</b>	428	610	25	5	2.5	0.35	1.95	2.90	1.91	306
<b>420</b>	620	150	134	6	2	2 520	4 130	200	320	420	<b>46284</b>	448	590	8	5	2	0.33	2.03	3.02	1.98	142
	620	188	150	6	2	3 390	5 660	267	320	430	<b>46284A</b>	448	589	19	5	2	0.39	1.74	2.59	1.70	176
	700	224	200	6	3	4 650	6 880	324	290	380	<b>46384</b>	448	656	12	5	2.5	0.39	1.74	2.59	1.70	325
	700	280	224	6	3	6 040	9 620	430	290	380	<b>46384A</b>	448	659	28	5	2.5	0.39	1.74	2.59	1.70	400

[Remark] Bearings not shown above (e.g. inch series) are shown in catalog "large size ball & roller bearings".

Double-row tapered roller bearings  
TDO type

d 440 ~ 500 mm



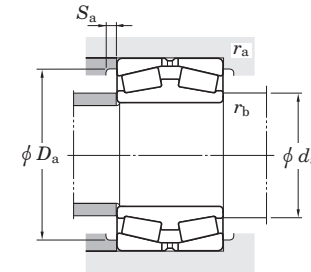
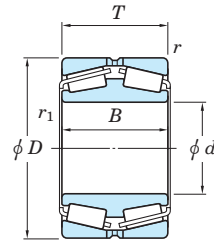
Boundary dimensions (mm)						Basic load ratings (kN)		Fatigue load limit (kN)	Limiting speeds (min <sup>-1</sup> )		Bearing No.	Mounting dimensions (mm)					Constant e	Axial load factors			(Refer.) Mass (kg)
d	D	T	C	r min.	r <sub>1</sub> min.	C <sub>r</sub>	C <sub>0r</sub>	C <sub>u</sub>	Grease lub.	Oil lub.		d <sub>a</sub> min.	D <sub>a</sub> min.	S <sub>a</sub> min.	r <sub>a</sub> max.	r <sub>b</sub> max.		Y <sub>2</sub>	Y <sub>3</sub>	Y <sub>0</sub>	
440	650	157	140	6	3	2 840	4 430	212	300	390	46288	468	622	8.5	5	2.5	0.33	2.03	3.02	1.98	156
	650	196	157	6	3	3 770	6 370	300	300	400		468	620	19.5	5	2.5	0.39	1.74	2.59	1.70	198
	720	226	201	6	3	4 950	8 110	372	270	360		468	676	12.5	5	2.5	0.39	1.74	2.59	1.70	354
	720	283	226	6	3	6 210	10 100	447	270	360		468	679	28.5	5	2.5	0.40	1.68	2.51	1.65	418
460	680	163	145	6	3	3 130	5 340	253	280	370	46292	488	637	9	5	2.5	0.37	1.83	2.72	1.78	196
	680	204	163	6	3	4 040	6 850	317	280	370		488	646	20.5	5	2.5	0.39	1.74	2.59	1.70	232
	760	240	214	7.5	4	5 460	9 000	408	250	330		496	710	13	6	3	0.39	1.74	2.59	1.70	424
	760	300	240	7.5	4	7 130	11 600	504	250	330		496	718	30	6	3	0.39	1.74	2.59	1.70	506
480	700	165	147	6	3	3 180	5 300	247	260	340	46296	508	672	9	5	2.5	0.33	2.03	3.02	1.98	186
	700	206	165	6	3	4 040	7 230	333	260	340		508	666	20.5	5	2.5	0.33	2.03	3.02	1.98	240
	790	248	221	7.5	4	5 820	8 920	405	230	310		516	742	13.5	6	3	0.39	1.74	2.59	1.70	457
	790	310	248	7.5	4	7 530	12 400	528	230	310		516	749	31	6	3	0.39	1.74	2.59	1.70	560
500	720	167	149	6	3	3 230	5 690	265	250	330	462/500	528	679	9	5	2.5	0.40	1.71	2.54	1.67	210
	720	209	167	6	3	4 390	7 850	356	250	330		528	690	21	5	2.5	0.42	1.62	2.41	1.58	258
	830	264	235	7.5	4	6 570	10 900	477	210	280		536	776	14.5	6	3	0.39	1.74	2.59	1.70	559
	830	330	264	7.5	4	8 510	14 000	586	210	280		536	784	33	6	3	0.39	1.74	2.59	1.70	669

[Remark] Bearings not shown above (e.g. inch series) are shown in catalog "large size ball & roller bearings".

# Double-row tapered roller bearings

## TDI type

$d$  100 ~ (220) mm

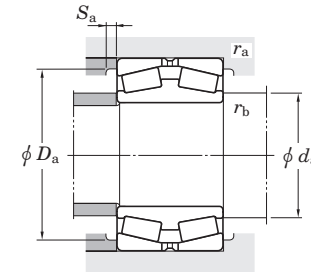
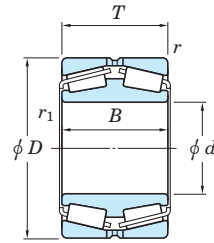


Boundary dimensions (mm)						Basic load ratings (kN)		Fatigue load limit (kN) $C_u$	Limiting speeds ( $\text{min}^{-1}$ )		Bearing No.	Mounting dimensions (mm)					Constant $e$	Axial load factors			(Refer.) Mass (kg)	
$d$	$D$	$B$	$T$	$r_{\text{min.}}$	$r_{1 \text{ min.}}$	$C_r$	$C_{0r}$		Grease lub.	Oil lub.		$d_a$ max.	$D_a$ max.	$S_a$ min.	$r_a$ max.	$r_b$ max.		$Y_2$	$Y_3$	$Y_0$		
100	165	52	52	2	2.5	298	384	28.0	1 800	2 300	45320	119	155	148	3.9	2	2	0.35	1.95	2.90	1.91	4.26
110	180	56	56	2	2.5	378	505	36.1	1 600	2 100	45322	128	170	160	4	2	2	0.35	1.95	2.90	1.91	5.40
120	180	46	46	2	2.5	286	424	29.7	1 500	2 100	45224	138	170	163	4	2	2	0.26	2.55	3.80	2.50	4.08
		200	62	62	2	2.5	444															
130	200	52	52	2	2.5	376	548	37.8	1 400	1 800	45226	152	190	179	4	2	2	0.27	2.47	3.67	2.41	5.96
		210	64	64	2	2.5	476															
140	210	53	53	2	2.5	390	564	38.5	1 300	1 800	45228	159	200	188	4	2	2	0.27	2.47	3.67	2.41	6.45
		225	68	68	2.5	3	611															
150	225	56	56	2.5	3	445	686	45.8	1 200	1 600	45230	174	213	203	4	2	2.5	0.26	2.55	3.80	2.50	7.87
		250	80	80	2.5	3	684															
160	240	60	60	2.5	3	488	705	46.6	1 100	1 500	45232	184	228	217	5	2	2.5	0.24	2.79	4.15	2.73	9.22
		270	86	86	2.5	3	832															
170	260	67	67	2.5	3	654	956	62.1	1 000	1 400	45234	195	248	233	5	2	2.5	0.31	2.21	3.29	2.16	12.4
		280	88	88	2.5	3	834															
180	280	74	74	2.5	3	722	1 050	62.5	950	1 300	45236	208	268	250	5	2	2.5	0.28	2.43	3.61	2.37	16.8
		300	96	96	3	4	992															
190	290	75	75	2.5	3	751	1 130	66.3	900	1 200	45238	219	278	260	5	2	2.5	0.26	2.55	3.80	2.50	17.7
		320	104	104	3	4	1 130															
200	310	82	82	2.5	3	913	1 410	83.1	830	1 100	45240	234	298	280	5	2	2.5	0.26	2.55	3.80	2.50	22.9
		340	112	112	3	4	1 250															
220	340	90	90	3	4	933	1 460	83.4	740	990	45244	259	326	306	5	2.5	3	0.28	2.43	3.61	2.37	28.5

[Remark] Bearings not shown above (e.g. inch series) are shown in catalog "large size ball & roller bearings".

# Double-row tapered roller bearings TDI type

$d$  (220) ~ (420) mm

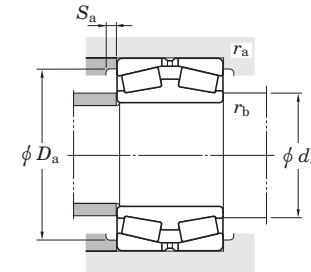
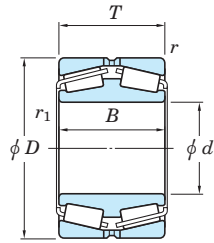


Boundary dimensions (mm)						Basic load ratings (kN)		Fatigue load limit (kN) $C_u$	Limiting speeds (min <sup>-1</sup> )		Bearing No.	Mounting dimensions (mm)					Constant $e$	Axial load factors			(Refer.) Mass (kg)	
$d$	$D$	$B$	$T$	$r_{min.}$	$r_{1 min.}$	$C_r$	$C_{0r}$		Grease lub.	Oil lub.		$d_a$ max.	$D_a$ max.	$S_a$ min.	$r_a$ max.	$r_b$ max.		$Y_2$	$Y_3$	$Y_0$		
<b>220</b>	370	120	120	4	5	1 400	2 060	113	700	930	<b>45344</b>	263	352	324	5	3	4	0.35	1.95	2.90	1.91	50.8
<b>230</b>	350	90	90	3	4	991	1 560	88.6	710	950	<b>45246</b>	267	336	318	6	2.5	3	0.28	2.43	3.61	2.37	30.6
<b>240</b>	360	92	92	3	4	1 150	1 790	99.8	690	920	<b>45248</b>	271	346	325	5	2.5	3	0.32	2.12	3.15	2.07	32.2
	400	128	128	4	5	1 650	2 470	133	630	840	<b>45348</b>	286	382	354	5	3	4	0.35	1.95	2.90	1.91	65.4
<b>260</b>	400	104	104	4	5	1 320	2 120	113	610	810	<b>45252</b>	302	382	360	6	3	4	0.25	2.74	4.08	2.68	48.1
	440	144	144	4	5	2 180	3 440	179	560	750	<b>45352</b>	313	422	386	6	3	4	0.35	1.95	2.90	1.91	92.2
<b>280</b>	420	106	106	4	5	1 490	2 470	133	560	750	<b>45256</b>	321	402	370	6	3	4	0.25	2.69	4.00	2.63	51.9
	460	146	146	5	6	2 310	3 320	175	520	700	<b>45356</b>	323	438	409	6	4	5	0.39	1.74	2.59	1.70	93.1
<b>300</b>	460	118	118	4	5	1 870	3 150	162	500	670	<b>45260</b>	350	442	418	6	3	4	0.25	2.74	4.08	2.68	78.5
	500	160	160	5	6	2 670	4 240	216	470	630	<b>45360</b>	356	478	440	6	4	5	0.35	1.95	2.90	1.91	129
<b>320</b>	480	121	121	4	5	1 830	3 180	161	470	630	<b>45264</b>	368	462	434	6	3	4	0.26	2.55	3.80	2.50	77.8
	540	176	176	5	6	3 380	5 280	264	430	570	<b>45364R</b>	378	518	474	6	4	5	0.32	2.12	3.15	2.07	167
<b>340</b>	520	133	133	5	6	2 380	3 850	186	420	570	<b>45268</b>	398	498	464	6	4	5	0.26	2.55	3.80	2.50	104
	580	190	190	5	6	3 790	5 470	269	390	510	<b>45368</b>	401	558	515	6	4	5	0.32	2.12	3.15	2.07	202
<b>360</b>	540	134	134	5	6	2 370	3 910	196	400	540	<b>45272</b>	408	518	488	11	4	5	0.32	2.12	3.15	2.07	101
	600	192	192	5	6	4 230	6 750	324	360	490	<b>45372</b>	419	578	528	10	4	5	0.32	2.12	3.15	2.07	228
<b>380</b>	560	135	135	5	6	2 300	3 790	185	380	500	<b>45276</b>	428	538	510	6	4	5	0.27	2.47	3.67	2.41	112
	620	194	194	5	6	3 860	6 360	303	340	450	<b>45376</b>	445	598	545	6	4	5	0.32	2.12	3.15	2.07	234
<b>400</b>	600	148	148	5	6	3 020	4 960	239	340	450	<b>45280</b>	452	578	545	6	4	5	0.33	2.03	3.02	1.98	143
	650	200	200	6	6	4 840	7 810	368	320	420	<b>45380</b>	458	622	580	11	5	5	0.39	1.74	2.59	1.70	265
<b>420</b>	620	150	150	5	6	3 010	5 200	248	320	430	<b>45284</b>	475	598	564	6	4	5	0.33	2.03	3.02	1.98	152

[Remark] Bearings not shown above (e.g. inch series) are shown in catalog "large size ball & roller bearings".

Double-row tapered roller bearings  
TDI type

$d$  (420) ~ 500 mm



$d$	Boundary dimensions (mm)					Basic load ratings (kN)		Fatigue load limit (kN) $C_u$	Limiting speeds ( $\text{min}^{-1}$ )		Bearing No.	Mounting dimensions (mm)					Constant $e$	Axial load factors			(Refer.) Mass (kg)	
	$D$	$B$	$T$	$r_{\text{min.}}$	$r_{1\text{ min.}}$	$C_r$	$C_{0r}$		Grease lub.	Oil lub.		$d_{a\text{ max.}}$	$D_{a\text{ max.}}$	$S_{a\text{ min.}}$	$r_{a\text{ max.}}$	$r_{b\text{ max.}}$		$Y_2$	$Y_3$	$Y_0$		
420	700	224	224	6	6	5 430	8 380	389	280	380	45384	488	672	623	7	5	5	0.39	1.74	2.59	1.70	352
440	650	157	157	6	6	3 190	5 500	256	300	390	45288	500	622	592	10	5	5	0.28	2.43	3.61	2.37	182
	720	226	226	6	6	5 750	9 130		417	270		360	506	692	642	7	5		5	0.39	1.74	
460	680	163	163	6	6	3 480	5 660	265	280	370	45292	510	652	616	6	5	5	0.39	1.74	2.59	1.70	197
	760	240	240	7.5	7.5	6 570	10 400		463	250		330	532	724	677	7	6		6	0.39	1.74	
480	700	165	165	6	6	3 830	6 710	307	260	350	45296	531	672	625	6	5	5	0.40	1.68	2.50	1.64	215
500	720	167	167	6	6	4 300	7 350	340	250	330	452/500	545	692	645	8	5	5	0.39	1.74	2.59	1.70	222
	830	264	264	7.5	7.5	7 970	12 300		555	210		280	587	794	729	7	6		6	0.33	2.03	

[Remark] Bearings not shown above (e.g. inch series) are shown in catalog "large size ball & roller bearings".

## Spherical roller bearings

Spherical roller bearings feature a large load rating capacity and self-aligning capability.

This type of bearing is suitable for low- or medium-speed applications which involve heavy or impact loading.

- These bearings are divided into R(RR), RH(RHR) and RHA types, which differ in internal structure. (refer to Table 1.)
- Each type can be produced with a cylindrical bore or tapered bore.

Bearings with a tapered bore can be fit and removed easily using an adapter assembly or withdrawal sleeve.

The rate of taper is equivalent among all bearing series.  
 240 and 241 series ... 1 : 30 (supplementary code "K30")  
 Others ... 1 : 12 (supplementary code "K")

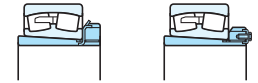
### Spherical roller bearings



Cylindrical bore    Tapered bore

Bore diameter **25 – 500 mm**

### Adapter assemblies

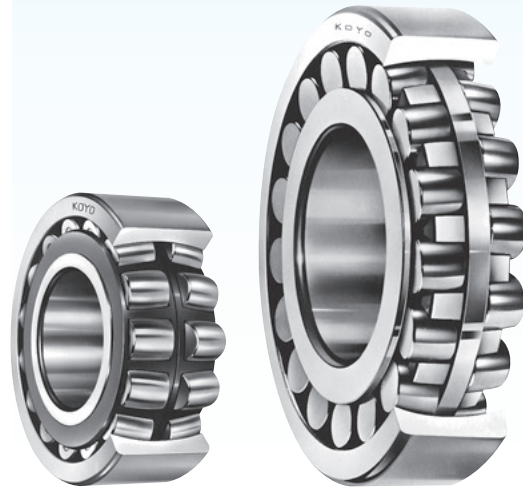


Bore diameter **20 – 470 mm**




### Withdrawal sleeves



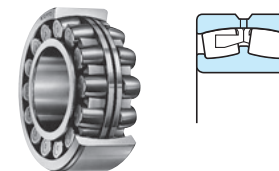
Bore diameter **35 – 480 mm**



**Table 1 Spherical roller bearings : types and structures**

Structure	 R, RR type	 RH, RHR type	 RHA type
Roller	Convex asymmetrical roller	Convex symmetrical roller	Convex symmetrical roller
Cage	Copper alloy prong type machined cage	Pressed steel cage	Copper alloy integral type machined cage
Inner ring (with or without rib)	With center rib	Without center rib (guide ring)	Without center rib (guide ring)
	With ribs on both sides (to prevent rollers from falling)	Without ribs on both sides	With ribs on both sides (to prevent rollers from falling)
Characteristics	Superior to RH, RHR and RHA types in high-speed performance.	The load rating capacity is larger than that of R and RR type. (There are some exceptional cases due to different interior specifications.)	

### ■ Spherical roller bearings for shaker screens



- These bearings consist of convex asymmetric rollers and a prong type, copper alloy, outer ring guided, machined cage. This cage possesses optimum characteristics for use with shaker screens.
- The bearings most commonly used with shaker screens are 223 series spherical roller bearings. They are identified by the supplementary code "ROVS W502." The outer ring outside diameter tolerance of these bearings is held to a small allowable variation.

■ Bearings with lubrication holes and a lubrication groove

- Outer rings can be provided with lubrication holes, a lubrication groove and an anti-rotation pin hole. (Specifications are given in Table 4.)
- Inner rings can also be provided with lubrication holes and a lubrication groove.

**Table 2 Supplementary codes for identification of bearings with lubrication holes, lubrication groove and anti-rotation pin hole (outer ring)**

Supplementary code		Number of lubrication holes	Hole layout
With lubrication holes and lubrication groove	With lubrication holes, lubrication groove and anti-rotation pin hole		
<b>W33</b>	<b>W3N</b>	3 <sup>1)</sup>	3 equally spaced positions <sup>1)</sup>
W33A	W3NA	4	4 equally spaced positions
—	W3NB	5	6 equally spaced positions <sup>2)</sup>
W33C	W3NC	6	6 equally spaced positions
—	W3ND	7	8 equally spaced positions <sup>2)</sup>
W33T	—	8	8 equally spaced positions

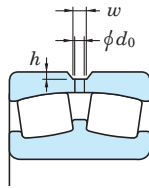
[Notes] 1) Also 4 or 6 holes are provided in smaller size bearings, consult with JTEKT.

2) One hole is used for the antirotation pin.

[Remark] Boldfaced codes indicate JTEKT standards.

**Table 3 Supplementary codes for identification of bearings with lubrication holes and/or lubrication groove**

Supplementary code	Inner ring		Outer ring	
	Number of lubrication holes	Lubrication groove	Number of lubrication holes	Lubrication groove
W513	3	—	3	○
W518	3	—	3	—
W26	3	—	—	—



**Table 4 (1) Lubrication hole and lubrication groove dimensions** Unit : mm

Bore diameter number	Nominal bore diameter d	239			230			240			231			241			222			232			213			223			
		d <sub>0</sub>	w	h	d <sub>0</sub>	w	h	d <sub>0</sub>	w	h	d <sub>0</sub>	w	h	d <sub>0</sub>	w	h	d <sub>0</sub>	w	h	d <sub>0</sub>	w	h	d <sub>0</sub>	w	h	d <sub>0</sub>	w	h	
5	25	—	—	—	—	—	—	—	—	—	—	—	—	—	—	—	—	—	—	—	—	—	—	—	—	—	—	—	—
6	30	—	—	—	—	—	—	—	—	—	—	—	—	—	—	—	—	—	—	—	—	—	—	—	—	—	—	—	—
7	35	—	—	—	—	—	—	—	—	—	—	—	—	—	—	—	—	—	—	—	—	—	—	—	—	—	—	—	—
8	40	—	—	—	—	—	—	—	—	—	—	—	—	—	—	—	—	—	—	—	—	—	—	—	—	—	—	—	—
9	45	—	—	—	—	—	—	—	—	—	—	—	—	—	—	—	—	—	—	—	—	—	—	—	—	—	—	—	—
10	50	—	—	—	—	—	—	—	—	—	—	—	—	—	—	—	—	—	—	—	—	—	—	—	—	—	—	—	—
11	55	—	—	—	—	—	—	—	—	—	—	—	—	—	—	—	—	—	—	—	—	—	—	—	—	—	—	—	—
12	60	—	—	—	—	—	—	—	—	—	—	—	—	—	—	—	—	—	—	—	—	—	—	—	—	—	—	—	—
13	65	—	—	—	—	—	—	—	—	—	—	—	—	—	—	—	—	—	—	—	—	—	—	—	—	—	—	—	—
14	70	—	—	—	—	—	—	—	—	—	—	—	—	—	—	—	—	—	—	—	—	—	—	—	—	—	—	—	—
15	75	—	—	—	—	—	—	—	—	—	—	—	—	—	—	—	—	—	—	—	—	—	—	—	—	—	—	—	—
16	80	—	—	—	—	—	—	—	—	—	—	—	—	—	—	—	—	—	—	—	—	—	—	—	—	—	—	—	—
17	85	—	—	—	—	—	—	—	—	—	—	—	—	—	—	—	—	—	—	—	—	—	—	—	—	—	—	—	—
18	90	—	—	—	—	—	—	—	—	—	—	—	—	—	—	—	—	—	—	—	—	—	—	—	—	—	—	—	—
19	95	—	—	—	—	—	—	—	—	—	—	—	—	—	—	—	—	—	—	—	—	—	—	—	—	—	—	—	—
20	100	—	—	—	4	5	1	—	—	—	—	—	—	—	—	—	—	—	—	—	—	—	—	—	—	—	—	—	—
22	110	—	—	—	5	7	1	—	—	—	—	—	—	—	—	—	—	—	—	—	—	—	—	—	—	—	—	—	—
24	120	—	—	—	5	7	1	5	6	1.4	5	6	1.4	6	8	1.5	5	7	1.5	6	10	1.7	—	—	—	—	—	—	—
26	130	—	—	—	5	7	1.2	6	8	1.5	5	6	1.5	6	8	1.5	5	7	1.5	6	10	1.7	—	—	—	—	—	—	—
28	140	4	5	1	5	7	1.2	6	8	1.5	6	8	1.5	8	10	2	6	8	1.8	8	10	2.5	—	—	—	—	—	—	—
30	150	5	7	1	5	8	1.2	6	8	1.5	6	10	1.5	8	10	2	6	10	1.8	8	10	2.5	—	—	—	—	—	—	—
32	160	5	7	1.2	5	8	1.2	6	8	1.5	8	12	2	10	12	2	10	12	2	10	12	2.5	—	—	—	—	—	—	—
34	170	5	7	1.2	6	10	1.5	8	10	2	8	12	2	10	12	2	12	14	3	10	12	2.5	—	—	—	—	—	—	—
36	180	6	7	1.3	8	12	1.5	10	12	2.5	10	12	2.5	10	12	2	12	14	3	10	12	2.5	—	—	—	—	—	—	—
38	190	5	7	1.2	10	12	2.5	10	12	2.5	10	12	2.5	10	12	2	12	14	3	12	14	3	—	—	—	—	—	—	—
40	200	6	8	1.5	10	12	2.5	10	12	2.5	12	14	3	12	14	3	12	14	3	12	14	3	—	—	—	—	—	—	—
44	220	6	8	1.5	10	12	2.5	10	12	2.5	12	14	3	12	14	3	12	14	3	12	14	3	—	—	—	—	—	—	—
48	240	6	8	1.5	10	12	2.5	10	12	2.5	12	14	3	12	14	3	14	16.5	4	14	16.5	4	—	—	—	—	—	—	—
52	260	10	12	2.5	12	14	3	12	14	3	12	14	3	12	14	3	14	16.5	4	14	16.5	4	—	—	—	—	—	—	—
56	280	10	12	2.5	12	14	3	12	14	3	12	14	3	12	14	3	14	16.5	4	14	16.5	4	—	—	—	—	—	—	—
60	300	10	12	2.5	12	14	3	12	14	3	12	14	3	12	14	3	14	16.5	4	14	16.5	4	—	—	—	—	—	—	—
64	320	10	12	2.5	12	14	3	12	14	3	14	16.5	4	14	16.5	4	14	16.5	4	14	16.5	4	—	—	—	—	—	—	—
68	340	12	14	3	14	16.5	4	14	16.5	4	14	16.5	4	14	16.5	4	14	16.5	4	14	16.5	4	—	—	—	—	—	—	—
72	360	12	14	3	14	16.5	4	14	16.5	4	14	16.5	4	14	16.5	4	14	16.5	4	14	16.5	4	—	—	—	—	—	—	—

**Table 4 (2) Lubrication hole and lubrication groove dimensions** Unit : mm

Bore diameter number	Nominal bore diameter d	239			230			240			231			241			222			232			213			223			
		d <sub>0</sub>	w	h	d <sub>0</sub>	w	h	d <sub>0</sub>	w	h	d <sub>0</sub>	w	h	d <sub>0</sub>	w	h	d <sub>0</sub>	w	h	d <sub>0</sub>	w	h	d <sub>0</sub>	w	h	d <sub>0</sub>	w	h	
76	380	12	14	3	14	16.5	4	14	16.5	4	14	16.5	4	14	16.5	4	—	—	—	14	16.5	4	—	—	—	—	—	—	—
80	400	12	14	3	14	16.5	4	14	16.5	4	14	16.5	4	14	16.5	4	—	—	—	14	16.5	4	—	—	—	—	—	—	—
84	420	12	14	3	14	16.5	4	14	16.5	4	14	16.5	4	14	16.5	4	—	—	—	14	16.5	4	—	—	—	—	—	—	—
88	440	14	16.5	4	14	16.5	4	14	16.5	4	14	16.5	4	14	16.5	4	—	—	—	14	16.5	4	—	—	—	—	—	—	—
92	460	14	16.5	4	14	16.5	4	14	16.5	4	14	16.5	4	14	16.5	4	—	—	—	14	16.5	4	—	—	—	—	—	—	—
96	480	14	16.5	4	14	16.5	4	14	16.5	4	14	16.5	4	14	16.5	4	—	—	—	14	16.5	4	—	—	—	—	—	—	—
/500	500	14	16.5	4	14	16.5	4	14	16.5	4	14	16.5	4	14	16.5	4	—	—	—	14	16.5	4	—	—	—	—	—	—	—

Boundary dimensions As specified in JIS B 1512.

Tolerances As specified in JIS B 1514-1, class 0. (refer to Table 7-3 on pp. A 60 – A 63.) Refer to Table 7-11 on p. A 76 for the tolerance of tapered bores.

Radial internal clearance As specified in JIS B 1520. (refer to Table 10-9 on p. A 108.)

Recommended fits Refer to Table 9-4 on pp. A 91, 92.

Standard cages Refer to Table 5.

Allowable aligning angle Refer to Table 5. (varies depending on bearing series.)

Equivalent radial load Dynamic equivalent radial load  

$$\left( \text{When } \frac{F_a}{F_r} \leq e \right) P_r = F_r + Y_1 F_a \quad \left( \text{When } \frac{F_a}{F_r} > e \right) P_r = 0.67 F_r + Y_2 F_a$$
 Static equivalent radial load  $P_{0r} = F_r + Y_0 F_a$   
 [Note] Refer to the specification table for the values of axial load factors  $Y_1$ ,  $Y_2$  and  $Y_0$  and of constant  $e$ .

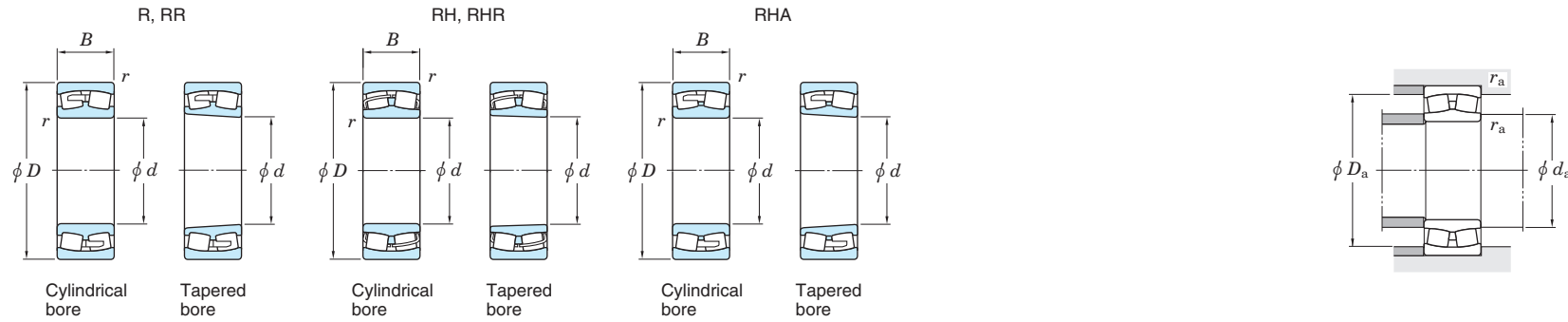
[Remark] If the ratio of axial load to radial load exceeds the value  $e$  given in the specification table ( $F_a/F_r > e$ ), slippage occurs between rollers in rows that are not axial-loaded and the raceway. This may cause smearing, especially when the bearing is large. Consult with JTEKT on the use of bearings under such conditions.

**Table 5 Application of standard cages and allowable aligning angle**

Bearing series	Standard cages		Allowable aligning angle
	Pressed cage	Machined cage	
239 R	—	23930R – 239/500R	0.026 rad (1.5°)
230 R	—	23038R – 230/500R	0.026 rad (1.5°)
RH	23022RH – 23036RH	—	—
RHA	—	23038RHA – 23096RHA	—
240 R(RR)	—	24036R – 240/500R	0.035 rad (2°)
RH	24024RH – 24034RH	—	—
RHA	—	24038RHA – 24096RHA	—
231 R	—	23136R – 231/500R	0.026 rad (1.5°)
RH	23122RH – 23134RH	—	—
RHA	—	23136RHA – 23196RHA	—
241 R(RR)	—	24132R – 241/500R	0.044 rad (2.5°)
RH	24122RH – 24130RH	—	—
RHA	—	24136RHA – 24196RHA	—
222 R(RR)	—	22232RR – 22272R	0.026 rad (1.5°)
RH(RHR)	22205RHR – 22230RH	—	—
RHA	—	22232RHA – 22260RHA	—
232 R	—	23232R – 232/500R	0.044 rad (2.5°)
RH	23218RH – 23230RH	—	—
RHA	—	23232RHA – 23296RHA	—
213 R	—	21322R – 21328R	0.017 rad (1°)

Spherical roller bearings

d 25 ~ 70 mm



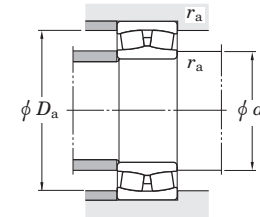
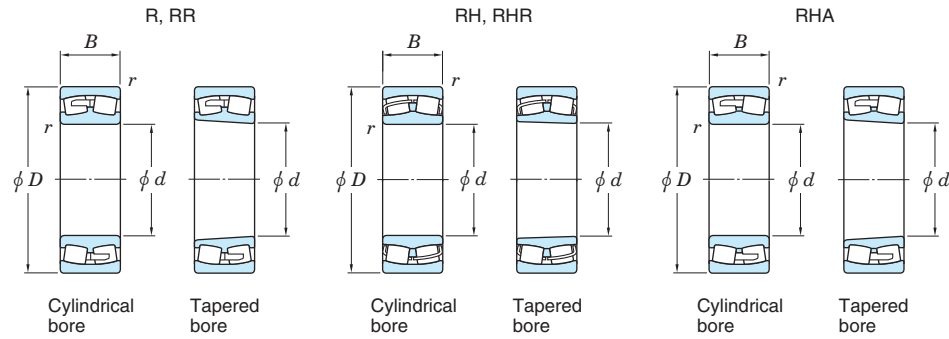
Boundary dimensions (mm)				Basic load ratings (kN)		Fatigue load limit (kN)	Limiting speeds (min <sup>-1</sup> )		Bearing No.		Mounting dimensions (mm)					Constant	Axial load factors			(Refer.) Mass (kg)	
d	D	B	r <sub>min.</sub>	C <sub>r</sub>	C <sub>0r</sub>	C <sub>u</sub>	Grease lub.	Oil lub.	Cylindrical bore	Tapered bore	d <sub>a</sub> min.	d <sub>a</sub> max.	D <sub>a</sub> max.	D <sub>a</sub> min.	r <sub>a</sub> max.	e	Y <sub>1</sub>	Y <sub>2</sub>	Y <sub>0</sub>	Cylindrical bore	Tapered bore
25	52	18	1	56.8	48.1	3.90	7 000	9 300	22205RHR	22205RHRK	31	31	46	46	1	0.35	1.91	2.85	1.87	0.188	0.184
30	62	20	1	76.6	65.9	5.30	5 900	7 900	22206RHR	22206RHRK	36	36.5	56	55.5	1	0.33	2.04	3.04	2.00	0.296	0.290
	72	19	1.1	74.2	62.7	4.80	5 200	7 000	21306RH	21306RHK	37	41.5	65	61.5	1	0.27	2.49	3.71	2.43	0.430	0.424
35	72	23	1.1	100	88.7	7.75	5 000	6 700	22207RHR	22207RHRK	42	42.5	65	64	1	0.32	2.09	3.11	2.04	0.459	0.449
	80	21	1.5	86.8	75.8	5.90	4 500	6 000	21307RH	21307RHK	43.5	46.5	71.5	68.5	1.5	0.27	2.49	3.71	2.43	0.572	0.564
40	80	23	1.1	114	102	9.55	4 500	6 000	22208RHR	22208RHRK	47	49	73	72.5	1	0.28	2.37	3.53	2.32	0.602	0.591
	90	23	1.5	105	92.8	7.55	4 100	5 500	21308RH	21308RHK	48.5	53.5	81.5	77	1.5	0.26	2.55	3.80	2.50	0.781	0.770
	90	33	1.5	170	152	11.8	4 100	5 500	22308RHR	22308RHRK	48.5	51	81.5	78.5	1.5	0.37	1.83	2.72	1.79	1.08	1.06
45	85	23	1.1	119	110	10.2	4 200	5 600	22209RHR	22209RHRK	52	53.5	78	77.5	1	0.26	2.55	3.80	2.50	0.602	0.590
	100	25	1.5	132	121	9.95	3 600	4 900	21309RH	21309RHK	53.5	60	91.5	86	1.5	0.26	2.62	3.90	2.56	1.05	1.04
	100	36	1.5	208	183	13.8	3 700	4 900	22309RHR	22309RHRK	53.5	55.5	91.5	87	1.5	0.37	1.83	2.72	1.79	1.42	1.39
50	90	23	1.1	128	122	12.7	3 900	5 200	22210RHR	22210RHRK	57	58.5	83	82.5	1	0.24	2.79	4.15	2.73	0.648	0.634
	110	27	2	157	147	12.0	3 300	4 400	21310RH	21310RHK	60	67	100	94.5	2	0.25	2.71	4.04	2.65	1.37	1.35
	110	40	2	255	237	17.5	3 300	4 500	22310RHR	22310RHRK	60	62.5	100	95.5	2	0.36	1.85	2.76	1.81	1.92	1.88
55	100	25	1.5	154	144	15.0	3 400	4 600	22211RHR	22211RHRK	63.5	64	91.5	91.5	1.5	0.24	2.84	4.23	2.78	0.867	0.849
	120	29	2	180	165	13.0	3 000	4 100	21311RH	21311RHK	65	71.5	110	101.5	2	0.25	2.71	4.03	2.65	1.69	1.67
	120	43	2	296	264	21.1	3 000	4 000	22311RHR	22311RHRK	65	66	110	104	2	0.36	1.85	2.76	1.81	2.40	2.35
60	110	28	1.5	190	181	18.7	3 100	4 200	22212RHR	22212RHRK	68.5	70	101.5	100	1.5	0.25	2.74	4.08	2.68	1.19	1.17
	130	31	2.1	210	193	15.1	2 800	3 700	21312RH	21312RHK	72	77.5	118	110	2	0.24	2.78	4.14	2.72	2.11	2.08
	130	46	2.1	354	334	24.9	2 800	3 700	22312RHR	22312RHRK	72	73.5	118	113	2	0.36	1.86	2.77	1.82	3.06	2.99
65	120	31	1.5	222	211	20.7	2 900	3 800	22213RHR	22213RHRK	73.5	76	111.5	109	1.5	0.25	2.69	4.00	2.63	1.55	1.52
	140	33	2.1	242	232	19.8	2 600	3 400	21313RH	21313RHK	77	85.5	128	119	2	0.24	2.83	4.21	2.76	2.62	2.58
	140	48	2.1	382	360	30.8	2 600	3 400	22313RHR	22313RHRK	77	79.5	128	122	2	0.34	1.98	2.94	1.93	3.66	3.58
70	125	31	1.5	233	222	24.4	2 700	3 600	22214RHR	22214RHRK	78.5	80	116.5	114	1.5	0.24	2.87	4.27	2.80	1.64	1.61
	150	35	2.1	268	260	21.6	2 400	3 200	21314RH	21314RHK	82	91	138	126.5	2	0.24	2.84	4.23	2.78	3.19	3.15
	150	51	2.1	435	413	35.0	2 400	3 200	22314RHR	22314RHRK	82	85.5	138	131	2	0.34	1.98	2.94	1.93	4.45	4.36

[Remark] Standard cage types used for the above bearings are shown in Table 5 earlier in this section.



Spherical roller bearings

d 75 ~ (110) mm

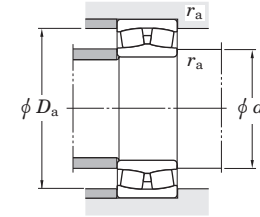
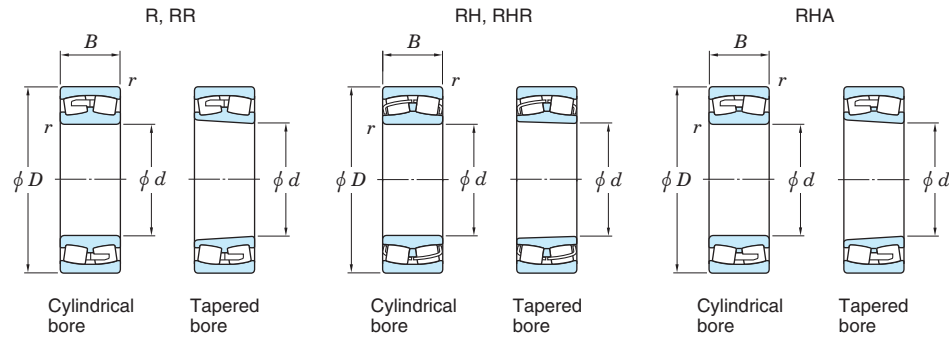


Boundary dimensions (mm)				Basic load ratings (kN)		Fatigue load limit (kN) C <sub>u</sub>	Limiting speeds (min <sup>-1</sup> )		Bearing No.		Mounting dimensions (mm)					Constant e	Axial load factors			(Refer.) Mass (kg)	
d	D	B	r <sub>min.</sub>	C <sub>r</sub>	C <sub>0r</sub>		Grease lub.	Oil lub.	Cylindrical bore	Tapered bore	d <sub>a</sub> min.	d <sub>a</sub> max.	D <sub>a</sub> max.	D <sub>a</sub> min.	r <sub>a</sub> max.		Y <sub>1</sub>	Y <sub>2</sub>	Y <sub>0</sub>	Cylindrical bore	Tapered bore
75	130	31	1.5	241	236	28.2	2 600	3 400	22215RHR	22215RHRK	83.5	85.5	121.5	119	1.5	0.22	3.07	4.57	3.00	1.73	1.69
	160	37	2.1	306	298	24.3	2 200	3 000	21315RH	21315RHK	87	98	148	138	2	0.24	2.87	4.27	2.80	3.81	3.76
	160	55	2.1	492	473	38.4	2 200	3 000	22315RHR	22315RHRK	87	91	148	139.5	2	0.35	1.95	2.90	1.91	5.45	5.33
80	140	33	2	271	271	30.5	2 400	3 200	22216RHR	22216RHRK	90	92	130	128	2	0.22	3.07	4.57	3.00	2.17	2.13
	170	39	2.1	344	339	27.5	2 100	2 800	21316RH	21316RHK	92	104	158	146	2	0.23	2.88	4.29	2.82	4.53	4.47
	170	58	2.1	539	521	41.7	2 100	2 800	22316RHR	22316RHRK	92	97	158	148	2	0.35	1.95	2.90	1.91	6.44	6.30
85	150	36	2	322	324	35.7	2 200	3 000	22217RHR	22217RHRK	95	97	140	137	2	0.22	3.01	4.48	2.94	2.75	2.69
	180	41	3	374	372	29.6	2 000	2 600	21317RH	21317RHK	99	109	166	154	2.5	0.23	2.89	4.33	2.83	5.32	5.25
	180	60	3	601	586	47.8	2 000	2 600	22317RHR	22317RHRK	99	103	166	157	2.5	0.33	2.02	3.00	1.97	7.47	7.31
90	160	40	2	372	381	39.2	2 100	2 800	22218RHR	22218RHRK	100	104	150	145	2	0.24	2.79	4.15	2.73	3.50	3.43
	160	52.4	2	421	482	42.9	2 100	2 800	23218RH	23218RHK	100	103	150	141	2	0.32	2.14	3.19	2.09	4.63	4.50
	190	43	3	413	416	32.9	1 900	2 500	21318RH	21318RHK	104	116	176	162	2.5	0.23	2.91	4.30	2.84	6.20	6.11
	190	64	3	672	662	50.5	1 900	2 500	22318RHR	22318RHRK	104	108	176	166	2.5	0.34	2.00	2.98	1.96	8.82	8.63
95	170	43	2.1	417	422	42.7	2 000	2 600	22219RHR	22219RHRK	107	109	158	154	2	0.24	2.76	4.11	2.70	4.24	4.15
	200	45	3	452	461	36.3	1 800	2 300	21319RH	21319RHK	109	123	186	171	2.5	0.23	2.92	4.35	2.86	7.16	7.06
	200	67	3	733	726	55.6	1 800	2 300	22319RHR	22319RHRK	109	114	186	174	2.5	0.33	2.02	3.00	1.97	10.2	9.98
100	150	37	1.5	262	332	33.7	2 100	2 800	23020RH	23020RHK	117	110	141	138	1.5	0.22	3.01	4.48	2.94	2.34	2.27
	180	46	2.1	470	481	47.6	1 900	2 500	22220RHR	22220RHRK	112	115	168	163	2	0.25	2.74	4.08	2.68	5.11	5.00
	180	60.3	2.1	533	629	53.5	1 900	2 500	23220RH	23220RHK	112	116	168	157	2	0.32	2.09	3.11	2.04	6.85	6.66
	215	47	3	519	524	40.2	1 600	2 200	21320RH	21320RHK	114	131	201	184	2.5	0.22	3.02	4.49	2.95	8.79	8.68
	215	73	3	875	877	63.9	1 600	2 200	22320RHR	22320RHRK	114	121	201	187	2.5	0.35	1.95	2.90	1.91	13.2	12.9
110	170	45	2	377	486	48.4	1 900	2 500	23022RH	23022RHK	120	123	160	156	2	0.24	2.84	4.23	2.78	3.85	3.74
	180	56	2	484	605	53.7	1 800	2 400	23122RH	23122RHK	120	125	170	161	2	0.29	2.36	3.51	2.31	5.72	5.54
	180	69	2	569	778	63.4	1 800	2 400	24122RH	24122RHK30	120	120	170	154	2	0.37	1.84	2.74	1.80	6.98	6.87
	200	53	2.1	612	642	58.7	1 700	2 200	22222RHR	22222RHRK	122	127	188	180	2	0.26	2.64	3.93	2.58	7.37	7.21
	200	69.8	2.1	672	792	65.4	1 700	2 200	23222RH	23222RHK	122	127	188	173	2	0.34	1.99	2.96	1.94	9.76	9.48
	240	50	3	604	616	46.0	1 400	1 900	21322RH	21322RHK	124	147	226	205	2.5	0.21	3.19	4.75	3.12	11.8	11.7

[Remark] Standard cage types used for the above bearings are shown in Table 5 earlier in this section.

Spherical roller bearings

$d$  (110) ~ (150) mm

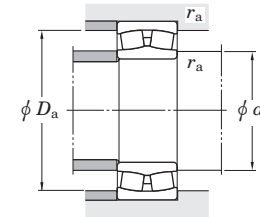
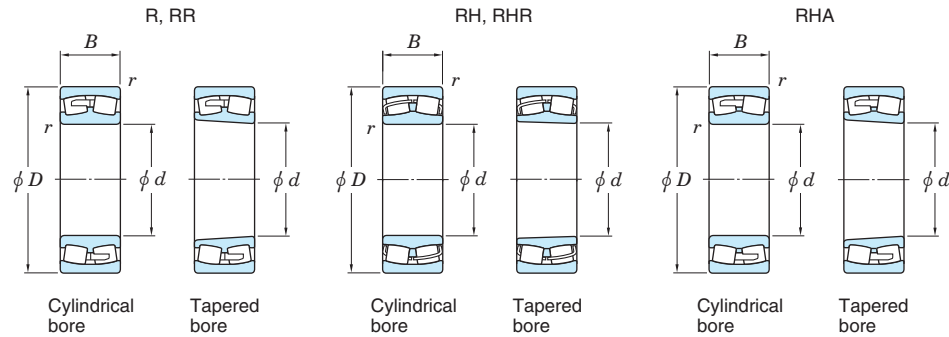


Boundary dimensions (mm)				Basic load ratings (kN)		Fatigue load limit (kN) $C_u$	Limiting speeds (min <sup>-1</sup> )		Bearing No.		Mounting dimensions (mm)					Constant $e$	Axial load factors			(Refer.) Mass (kg)	
$d$	$D$	$B$	$r_{min.}$	$C_r$	$C_{Or}$		Grease lub.	Oil lub.	Cylindrical bore	Tapered bore	$d_a$ min.	$d_a$ max.	$D_a$ max.	$D_a$ min.	$r_a$ max.		$Y_1$	$Y_2$	$Y_0$	Cylindrical bore	Tapered bore
110	240	80	3	1 040	1 040	77.7	1 400	1 900	22322RHR	22322RHRK	124	136	226	208	2.5	0.33	2.03	3.02	1.98	18.1	17.7
	180	46	2	394	524	51.6	1 700	2 300	23024RH	23024RHK	130	132	170	165	2	0.23	2.95	4.40	2.89	4.20	4.07
120	180	60	2	484	709	61.8	1 700	2 300	24024RH	24024RHK30	130	130	170	160	2	0.30	2.23	3.32	2.18	5.43	5.34
	200	62	2	571	714	61.2	1 600	2 200	23124RH	23124RHK	130	137	190	176	2	0.29	2.34	3.49	2.29	7.98	7.74
	200	80	2	733	1 020	78.6	1 600	2 200	24124RH	24124RHK30	130	133	190	172	2	0.38	1.75	2.61	1.72	10.2	10.0
	215	58	2.1	706	764	67.2	1 500	2 000	22224RHR	22224RHRK	132	138	203	193	2	0.26	2.60	3.87	2.54	9.31	9.10
	215	76	2.1	772	956	78.9	1 500	2 100	23224RH	23224RHK	132	139	203	185	2	0.34	1.97	2.94	1.93	12.2	11.8
	260	86	3	1 120	1 130	87.2	1 300	1 800	22324RHR	22324RHRK	134	149	246	228	2.5	0.33	2.03	3.02	1.98	22.8	22.3
	200	52	2	509	674	63.6	1 600	2 100	23026RH	23026RHK	140	145	190	182	2	0.24	2.87	4.27	2.80	6.15	5.97
	200	69	2	625	914	77.3	1 600	2 100	24026RH	24026RHK30	140	143	190	177	2	0.32	2.14	3.18	2.09	8.03	7.90
130	210	64	2	621	799	68.4	1 500	2 000	23126RH	23126RHK	140	147	200	187	2	0.28	2.42	3.61	2.37	8.71	8.44
	210	80	2	754	1 080	91.8	1 500	2 000	24126RH	24126RHK30	140	145	200	184	2	0.36	1.90	2.83	1.86	10.8	10.6
	230	64	3	821	914	74.4	1 400	1 900	22226RHR	22226RHRK	144	148	216	206	2.5	0.26	2.55	3.80	2.50	11.6	11.3
	230	80	3	880	1 090	89.4	1 400	1 900	23226RH	23226RHK	144	151	216	201	2.5	0.33	2.05	3.05	2.00	14.4	14.0
	280	93	4	1 310	1 340	98.6	1 200	1 600	22326RHR	22326RHRK	148	160	262	245	3	0.33	2.03	3.02	1.98	28.5	27.9
	210	53	2	530	723	67.9	1 500	2 000	23028RH	23028RHK	150	155	200	192	2	0.23	2.98	4.44	2.92	6.62	6.42
140	210	69	2	640	957	81.7	1 500	2 000	24028RH	24028RHK30	150	153	200	188	2	0.30	2.28	3.39	2.23	8.49	8.35
	225	68	2.1	710	940	79.6	1 400	1 900	23128RH	23128RHK	152	158	213	201	2	0.28	2.45	3.65	2.40	10.6	10.3
	225	85	2.1	853	1 220	90.7	1 400	1 900	24128RH	24128RHK30	152	153	213	194	2	0.36	1.89	2.82	1.85	13.1	12.9
	250	68	3	947	1 030	85.2	1 300	1 700	22228RHR	22228RHRK	154	158	236	224	2.5	0.26	2.60	3.87	2.54	14.5	14.2
	250	88	3	1 020	1 290	103	1 300	1 700	23228RH	23228RHK	154	161	236	214	2.5	0.34	1.99	2.96	1.95	19.0	18.4
	300	102	4	1 470	1 570	105	1 100	1 500	22328RH	22328RHK	158	172	282	255	3	0.35	1.95	2.90	1.90	35.7	34.9
	210	45	2	418	622	62.5	1 600	2 100	23930R	23930RK	160	170	200	195	2	0.20	3.44	5.12	3.36	5.09	4.93
	150	225	56	2.1	579	797	76.3	1 400	1 800	23030RH	23030RHK	162	166	213	205	2	0.22	3.04	4.53	2.97	8.01
225		75	2.1	724	1 100	90.3	1 400	1 800	24030RH	24030RHK30	162	163	213	199	2	0.30	2.23	3.32	2.18	10.6	10.4
250		80	2.1	902	1 230	102	1 300	1 700	23130RH	23130RHK	162	171	238	216	2	0.30	2.24	3.34	2.19	16.4	15.9
250		100	2.1	1 110	1 590	116	1 300	1 700	24130RH	24130RHK30	162	166	238	213	2	0.38	1.77	2.64	1.73	19.9	19.6

[Remark] Standard cage types used for the above bearings are shown in Table 5 earlier in this section.

Spherical roller bearings

d (150) ~ (180) mm

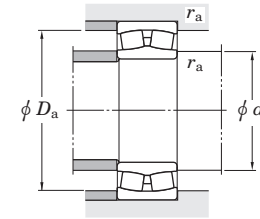
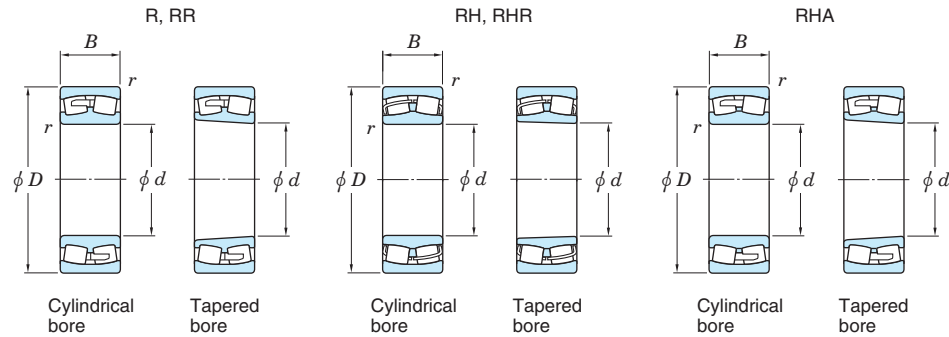


Boundary dimensions (mm)				Basic load ratings (kN)		Fatigue load limit (kN) C <sub>u</sub>	Limiting speeds (min <sup>-1</sup> )		Bearing No.		Mounting dimensions (mm)					Constant e	Axial load factors			(Refer.) Mass (kg)	
d	D	B	r <sub>min.</sub>	C <sub>r</sub>	C <sub>0r</sub>		Grease lub.	Oil lub.	Cylindrical bore	Tapered bore	d <sub>a</sub> min.	d <sub>a</sub> max.	D <sub>a</sub> max.	D <sub>a</sub> min.	r <sub>a</sub> max.		Y <sub>1</sub>	Y <sub>2</sub>	Y <sub>0</sub>	Cylindrical bore	Tapered bore
150	270	73	3	1 080	1 200	102	1 200	1 600	22230RHR	22230RHRK	164	172	256	243	2.5	0.25	2.69	4.00	2.63	18.9	18.5
	270	96	3	1 200	1 540	121	1 200	1 600	23230RH	23230RHK	164	173	256	230	2.5	0.34	1.96	2.93	1.92	24.5	23.8
	320	108	4	1 540	1 600	175	1 200	1 500	22330R	22330RK	168	195	302	273	3	0.38	1.78	2.64	1.74	43.6	42.7
	320	108	4	1 620	1 740	121	1 200	1 500	22330RHA	22330RHAK	168	196	302	273	3	0.35	1.93	2.87	1.88	40.3	39.4
160	220	45	2	426	649	65.4	1 500	2 000	23932R	23932RK	170	179	210	204	2	0.19	3.60	5.37	3.52	5.37	5.20
	240	60	2.1	667	924	86.0	1 300	1 700	23032RH	23032RHK	172	177	228	219	2	0.22	3.01	4.48	2.94	9.74	9.44
	240	80	2.1	829	1 270	103	1 300	1 700	24032RH	24032RHK30	172	175	228	215	2	0.30	2.24	3.34	2.19	12.9	12.7
	270	86	2.1	1 070	1 430	117	1 200	1 600	23132RH	23132RHK	172	182	258	234	2	0.30	2.22	3.30	2.17	20.8	20.2
	270	109	2.1	1 270	1 720	145	1 700	1 300	24132RR	24132RRK30	172	188	258	230	2	0.39	1.72	2.56	1.68	25.9	25.5
	290	80	3	1 110	1 270	127	1 200	1 600	22232R	22232RK	174	199	276	257	2.5	0.28	2.40	3.57	2.35	23.4	22.9
	290	80	3	1 120	1 320	97.1	1 200	1 600	22232RHA	22232RHAK	174	200	276	257	2.5	0.27	2.49	3.71	2.44	21.9	21.4
	290	104	3	1 290	1 650	163	1 200	1 600	23232R	23232RK	174	194	276	245	2.5	0.38	1.79	2.66	1.75	31.0	30.1
	290	104	3	1 370	1 780	139	1 200	1 600	23232RHA	23232RHAK	174	193	276	245	2.5	0.36	1.87	2.78	1.83	29.4	28.5
	340	114	4	1 720	1 790	188	1 100	1 400	22332R	22332RK	178	207	322	290	3	0.38	1.76	2.62	1.72	51.9	51.0
	340	114	4	1 780	1 940	135	1 100	1 400	22332RHA	22332RHAK	178	210	322	290	3	0.35	1.94	2.89	1.90	48.0	47.1
	170	230	45	2	441	691	69.6	1 400	1 900	23934R	23934RK	180	189	220	214	2	0.18	3.78	5.63	3.70	5.67
260		67	2.1	795	1 090	97.9	1 200	1 600	23034RH	23034RHK	182	189	248	236	2	0.23	2.90	4.31	2.83	13.2	12.8
260		90	2.1	1 010	1 540	120	1 200	1 600	24034RH	24034RHK30	182	184	248	227	2	0.32	2.11	3.15	2.07	17.5	17.2
280		88	2.1	1 150	1 550	124	1 100	1 500	23134RH	23134RHK	182	194	268	249	2	0.29	2.30	3.43	2.25	21.9	21.2
280		109	2.1	1 320	1 820	154	1 600	1 200	24134RR	24134RRK30	182	198	268	241	2	0.37	1.80	2.68	1.76	27.2	26.8
310		86	4	1 190	1 390	141	1 100	1 500	22234R	22234RK	188	212	292	271	3	0.29	2.29	3.41	2.24	29.0	28.4
310		86	4	1 260	1 490	109	1 100	1 500	22234RHA	22234RHAK	188	210	292	271	3	0.28	2.45	3.64	2.39	27.1	26.5
310		110	4	1 560	1 920	127	1 100	1 500	23234RR	23234RRK	188	209	292	268	3	0.37	1.85	2.75	1.80	37.2	36.1
310		110	4	1 520	1 940	147	1 100	1 500	23234RHA	23234RHAK	188	207	292	261	3	0.36	1.89	2.82	1.85	35.6	34.6
360		120	4	1 830	1 920	206	1 000	1 300	22334R	22334RK	188	221	342	307	3	0.38	1.77	2.64	1.73	62.0	60.8
360		120	4	1 990	2 200	150	1 000	1 300	22334RHA	22334RHAK	188	222	342	307	3	0.35	1.95	2.91	1.91	57.3	56.1
180		250	52	2	599	939	88.9	1 300	1 700	23936R	23936RK	190	203	240	232	2	0.19	3.55	5.29	3.48	8.22
	280	74	2.1	966	1 330	118	1 100	1 400	23036RH	23036RHK	192	202	268	253	2	0.24	2.84	4.23	2.78	17.4	16.9

[Remark] Standard cage types used for the above bearings are shown in Table 5 earlier in this section.

Spherical roller bearings

d (180) ~ (200) mm

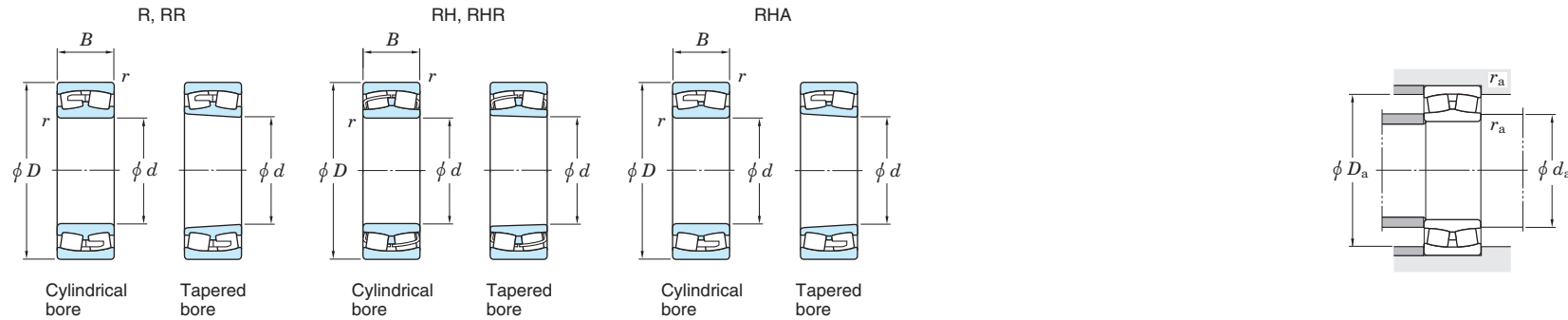


Boundary dimensions (mm)				Basic load ratings (kN)		Fatigue load limit (kN) C <sub>u</sub>	Limiting speeds (min <sup>-1</sup> )		Bearing No.		Mounting dimensions (mm)					Constant e	Axial load factors			(Refer.) Mass (kg)	
d	D	B	r <sub>min.</sub>	C <sub>r</sub>	C <sub>0r</sub>		Grease lub.	Oil lub.	Cylindrical bore	Tapered bore	d <sub>a</sub> min.	d <sub>a</sub> max.	D <sub>a</sub> max.	D <sub>a</sub> min.	r <sub>a</sub> max.		Y <sub>1</sub>	Y <sub>2</sub>	Y <sub>0</sub>	Cylindrical bore	Tapered bore
180	280	100	2.1	1 170	1 710	138	1 600	1 200	24036RR	24036RRK30	192	206	268	246	2	0.34	2.00	2.98	1.96	23.4	23.0
	300	96	3	1 260	1 800	165	1 100	1 500	23136R	23136RK	194	214	286	259	2.5	0.33	2.04	3.04	2.00	28.4	27.5
	300	96	3	1 330	1 790	139	1 100	1 500	23136RHA	23136RHAK	194	215	286	265	2.5	0.31	2.19	3.25	2.14	26.5	25.6
	300	118	3	1 530	2 120	176	1 100	1 500	24136RR	24136RRK30	194	211	286	258	2.5	0.38	1.78	2.65	1.74	34.4	33.9
	300	118	3	1 510	2 240	155	1 100	1 500	24136RHA	24136RHAK30	194	207	286	255	2.5	0.38	1.79	2.66	1.75	31.8	31.2
	320	86	4	1 220	1 450	165	1 100	1 400	22236R	22236RK	198	222	302	281	3	0.28	2.37	3.53	2.32	30.5	29.8
	320	86	4	1 320	1 610	118	1 100	1 400	22236RHA	22236RHAK	198	221	302	281	3	0.26	2.55	3.80	2.50	28.5	27.8
	320	112	4	1 640	2 100	134	1 100	1 400	23236RR	23236RRK	198	219	302	279	3	0.36	1.87	2.78	1.83	39.8	38.6
	320	112	4	1 660	2 170	166	1 100	1 400	23236RHA	23236RHAK	198	220	302	277	3	0.34	1.97	2.93	1.92	37.7	36.5
	380	126	4	2 180	2 360	263	920	1 200	22336R	22336RK	198	237	362	327	3	0.36	1.89	2.81	1.84	71.4	69.9
	380	126	4	2 180	2 410	163	930	1 200	22336RHA	22336RHAK	198	235	362	323	3	0.34	1.97	2.94	1.93	66.0	64.5
	190	260	52	2	608	969	90.7	1 200	1 600	23938R	23938RK	200	212	250	241	2	0.18	3.69	5.50	3.61	8.40
290		75	2.1	923	1 370	132	1 100	1 500	23038R	23038RK	202	221	278	260	2	0.25	2.67	3.97	2.61	18.8	18.2
290		75	2.1	992	1 430	115	1 100	1 500	23038RHA	23038RHAK	202	219	278	260	2	0.25	2.75	4.10	2.69	17.2	16.6
290		100	2.1	1 240	1 840	161	1 100	1 500	24038RR	24038RRK30	202	215	278	257	2	0.33	2.06	3.07	2.02	24.5	24.1
290		100	2.1	1 230	1 920	152	1 100	1 500	24038RHA	24038RHAK30	202	215	278	256	2	0.32	2.14	3.19	2.09	22.4	22.0
320		104	3	1 370	2 000	162	1 000	1 400	23138R	23138RK	204	229	306	275	2.5	0.34	1.96	2.92	1.92	35.5	34.4
320		104	3	1 520	2 080	161	1 000	1 400	23138RHA	23138RHAK	204	227	306	281	2.5	0.31	2.14	3.19	2.10	33.2	32.1
320		128	3	1 750	2 470	198	1 000	1 400	24138RR	24138RRK30	204	223	306	272	2.5	0.39	1.74	2.59	1.70	43.0	42.4
320		128	3	1 770	2 630	179	1 000	1 400	24138RHA	24138RHAK30	204	222	306	272	2.5	0.38	1.76	2.63	1.72	40.1	39.5
340		92	4	1 390	1 730	172	1 000	1 300	22238R	22238RK	208	236	322	296	3	0.29	2.29	3.41	2.24	37.4	36.6
340		92	4	1 420	1 770	128	1 000	1 300	22238RHA	22238RHAK	208	234	322	296	3	0.27	2.52	3.76	2.46	34.9	34.1
340		120	4	1 830	2 370	160	1 000	1 300	23238RR	23238RRK	208	233	322	294	3	0.36	1.86	2.76	1.81	48.5	47.1
340		120	4	1 870	2 470	185	990	1 300	23238RHA	23238RHAK	208	233	322	293	3	0.35	1.94	2.89	1.90	44.9	43.5
400		132	5	2 380	2 610	258	880	1 200	22338R	22338RK	212	248	378	342	4	0.38	1.79	2.66	1.75	84.1	82.4
400		132	5	2 430	2 810	192	870	1 200	22338RHA	22338RHAK	212	251	378	342	4	0.34	1.99	2.97	1.95	77.7	76.0
200		280	60	2.1	753	1 190	109	1 100	1 500	23940R	23940RK	212	226	268	259	2	0.20	3.44	5.13	3.37	12.0
	310	82	2.1	1 120	1 670	155	1 000	1 400	23040R	23040RK	212	235	298	278	2	0.26	2.62	3.90	2.56	24.1	23.4
	310	82	2.1	1 180	1 680	133	1 100	1 400	23040RHA	23040RHAK	212	231	298	278	2	0.25	2.68	3.99	2.62	22.0	21.3

[Remark] Standard cage types used for the above bearings are shown in Table 5 earlier in this section.

Spherical roller bearings

d (200) ~ (240) mm

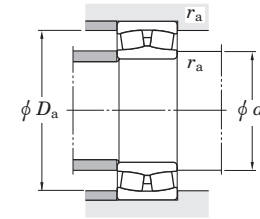
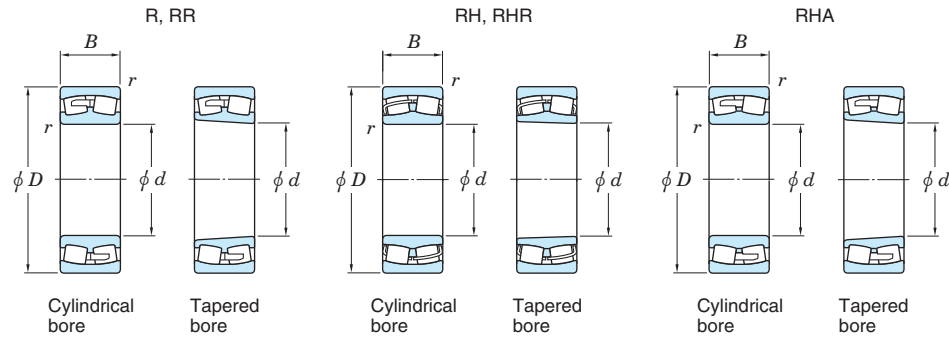


Boundary dimensions (mm)				Basic load ratings (kN)		Fatigue load limit (kN) C <sub>u</sub>	Limiting speeds (min <sup>-1</sup> )		Bearing No.		Mounting dimensions (mm)					Constant e	Axial load factors			(Refer.) Mass (kg)	
d	D	B	r <sub>min.</sub>	C <sub>r</sub>	C <sub>0r</sub>		Grease lub.	Oil lub.	Cylindrical bore	Tapered bore	d <sub>a</sub> min.	d <sub>a</sub> max.	D <sub>a</sub> max.	D <sub>a</sub> min.	r <sub>a</sub> max.		Y <sub>1</sub>	Y <sub>2</sub>	Y <sub>0</sub>	Cylindrical bore	Tapered bore
200	310	109	2.1	1 430	2 110	180	1 100	1 400	24040RR	24040RRK30	212	228	298	273	2	0.33	2.02	3.00	1.97	31.2	30.7
	310	109	2.1	1 440	2 230	173	1 100	1 400	24040RHA	24040RHAK30	212	227	298	272	2	0.33	2.06	3.07	2.02	28.5	28.0
	340	112	3	1 740	2 350	186	980	1 300	23140RR	23140RRK	214	241	326	298	2.5	0.33	2.04	3.03	1.99	43.3	42.0
	340	112	3	1 730	2 340	178	970	1 300	23140RHA	23140RHAK	214	239	326	297	2.5	0.32	2.10	3.13	2.06	40.8	39.5
	340	140	3	2 030	2 820	222	990	1 300	24140RR	24140RRK30	214	234	326	289	2.5	0.40	1.68	2.49	1.64	53.3	52.5
	340	140	3	2 000	2 970	196	990	1 300	24140RHA	24140RHAK30	214	232	326	286	2.5	0.41	1.65	2.46	1.62	49.5	48.7
	360	98	4	1 620	2 050	138	930	1 200	22240RR	22240RRK	218	252	342	316	3	0.30	2.26	3.36	2.21	45.0	44.0
	360	98	4	1 630	2 030	146	940	1 300	22240RHA	22240RHAK	218	247	342	316	3	0.27	2.50	3.72	2.45	42.0	41.0
	360	128	4	1 950	2 610	228	940	1 300	23240R	23240RK	218	244	342	306	3	0.38	1.79	2.67	1.75	58.1	56.4
	360	128	4	2 080	2 780	209	930	1 200	23240RHA	23240RHAK	218	245	342	309	3	0.35	1.92	2.86	1.88	55.1	53.4
	420	138	5	2 510	2 750	288	830	1 100	22340R	22340RK	222	260	398	359	4	0.38	1.80	2.68	1.76	95.4	93.5
	420	138	5	2 570	2 920	193	820	1 100	22340RHA	22340RHAK	222	262	398	356	4	0.34	1.99	2.97	1.95	88.1	86.2
220	300	60	2.1	792	1 300	119	1 000	1 400	23944R	23944RK	232	246	288	279	2	0.18	3.70	5.50	3.61	13.0	12.6
	340	90	3	1 230	1 890	173	940	1 300	23044R	23044RK	234	256	326	301	2.5	0.26	2.55	3.80	2.50	31.5	30.6
	340	90	3	1 370	1 950	148	940	1 200	23044RHA	23044RHAK	234	255	326	307	2.5	0.25	2.69	4.01	2.63	28.8	27.9
	340	118	3	1 660	2 480	208	950	1 300	24044RR	24044RRK30	234	251	326	300	2.5	0.33	2.04	3.04	2.00	40.5	39.8
	340	118	3	1 680	2 630	199	950	1 300	24044RHA	24044RHAK30	234	248	326	297	2.5	0.33	2.08	3.09	2.03	37.0	36.4
	370	120	4	1 810	2 700	205	880	1 200	23144R	23144RK	238	266	352	319	3	0.34	2.00	2.98	1.96	54.8	53.2
	370	120	4	2 000	2 790	208	870	1 200	23144RHA	23144RHAK	238	263	352	324	3	0.31	2.15	3.20	2.10	51.2	49.6
	370	150	4	2 360	3 390	258	880	1 200	24144RR	24144RRK30	238	258	352	315	3	0.39	1.71	2.55	1.67	67.3	66.2
	370	150	4	2 330	3 550	229	880	1 200	24144RHA	24144RHAK30	238	255	352	313	3	0.40	1.69	2.52	1.65	62.0	61.0
	400	108	4	2 000	2 410	257	820	1 100	22244RR	22244RRK	238	276	382	355	3	0.28	2.40	3.57	2.34	60.3	59.0
	400	108	4	1 980	2 440	168	820	1 100	22244RHA	22244RHAK	238	274	382	349	3	0.27	2.52	3.76	2.47	58.8	57.5
	400	144	4	2 350	3 200	259	830	1 100	23244R	23244RK	238	268	382	336	3	0.39	1.71	2.55	1.68	81.6	79.2
	400	144	4	2 520	3 350	239	810	1 100	23244RHA	23244RHAK	238	272	382	346	3	0.36	1.89	2.81	1.85	77.4	75.0
	460	145	5	2 980	3 380	359	720	960	22344R	22344RK	242	290	438	393	4	0.34	2.00	2.99	1.96	124	122
460	145	5	2 960	3 470	226	730	970	22344RHA	22344RHAK	242	290	438	390	4	0.32	2.08	3.09	2.03	115	113	
240	320	60	2.1	814	1 380	128	940	1 300	23948R	23948RK	252	265	308	298	2	0.17	3.95	5.88	3.86	14.0	13.5
	360	92	3	1 480	2 190	161	860	1 100	23048RR	23048RRK	254	276	346	327	2.5	0.25	2.73	4.07	2.67	33.9	32.9

[Remark] Standard cage types used for the above bearings are shown in Table 5 earlier in this section.

Spherical roller bearings

d (240) ~ (280) mm

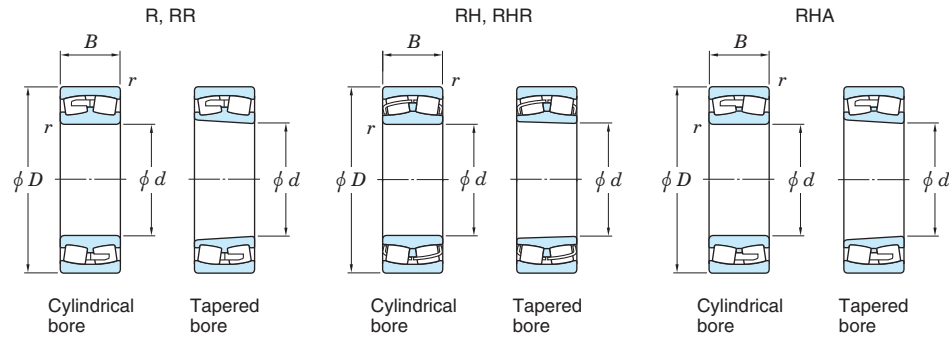


Boundary dimensions (mm)				Basic load ratings (kN)		Fatigue load limit (kN) C <sub>u</sub>	Limiting speeds (min <sup>-1</sup> )		Bearing No.		Mounting dimensions (mm)					Constant e	Axial load factors			(Refer.) Mass (kg)	
d	D	B	r <sub>min.</sub>	C <sub>r</sub>	C <sub>0r</sub>		Grease lub.	Oil lub.	Cylindrical bore	Tapered bore	d <sub>a</sub> min.	d <sub>a</sub> max.	D <sub>a</sub> max.	D <sub>a</sub> min.	r <sub>a</sub> max.		Y <sub>1</sub>	Y <sub>2</sub>	Y <sub>0</sub>	Cylindrical bore	Tapered bore
240	360	92	3	1 470	2 180	166	860	1 100	23048RHA	23048RHAK	254	275	346	327	2.5	0.24	2.83	4.21	2.77	31.9	30.9
	360	118	3	1 750	2 710	228	870	1 200	24048RR	24048RRK30	254	272	346	321	2.5	0.31	2.20	3.27	2.15	43.5	42.9
	360	118	3	1 750	2 840	215	870	1 200	24048RHA	24048RHAK30	254	269	346	321	2.5	0.30	2.24	3.33	2.19	39.6	39.0
	400	128	4	2 280	3 220	213	790	1 100	23148RR	23148RRK	258	287	382	353	3	0.32	2.11	3.14	2.06	67.2	65.1
	400	128	4	2 270	3 200	233	790	1 000	23148RHA	23148RHAK	258	286	382	353	3	0.31	2.19	3.25	2.14	63.1	61.1
	400	160	4	2 640	3 850	287	800	1 100	24148RR	24148RRK30	258	280	382	340	3	0.39	1.75	2.60	1.71	82.7	81.4
	400	160	4	2 670	4 130	262	800	1 100	24148RHA	24148RHAK30	258	278	382	340	3	0.39	1.72	2.56	1.68	76.6	75.3
	440	120	4	2 390	2 940	295	730	970	22248R	22248RK	258	299	422	384	3	0.29	2.35	3.50	2.30	85.0	83.2
	440	120	4	2 400	2 990	202	730	970	22248RHA	22248RHAK	258	299	422	384	3	0.27	2.49	3.71	2.43	79.4	77.6
	440	160	4	3 050	3 970	310	730	970	23248RR	23248RRK	258	295	422	376	3	0.38	1.78	2.64	1.74	110	107
	440	160	4	3 080	4 130	289	730	970	23248RHA	23248RHAK	258	295	422	376	3	0.36	1.87	2.78	1.83	104	101
	500	155	5	3 360	4 200	347	650	870	22348R	22348RK	262	320	478	420	4	0.35	1.94	2.89	1.90	157	154
	500	155	5	3 400	3 990	255	650	870	22348RHA	22348RHAK	262	315	478	426	4	0.32	2.12	3.16	2.07	145	142
	260	360	75	2.1	1 140	1 880	160	820	1 100	23952R	23952RK	272	292	348	333	2	0.19	3.54	5.27	3.46	24.0
400		104	4	1 670	2 570	212	760	1 000	23052R	23052RK	278	304	382	359	3	0.25	2.65	3.95	2.59	50.7	49.3
400		104	4	1 850	2 720	201	760	1 000	23052RHA	23052RHAK	278	302	382	359	3	0.25	2.75	4.10	2.69	46.3	44.9
400		140	4	2 280	3 570	282	770	1 000	24052RR	24052RRK30	278	296	382	352	3	0.33	2.02	3.01	1.98	66.3	65.2
400		140	4	2 270	3 670	265	770	1 000	24052RHA	24052RHAK30	278	292	382	347	3	0.33	2.06	3.07	2.02	60.3	59.4
440		144	4	2 760	3 850	231	710	940	23152RR	23152RRK	278	313	422	387	3	0.33	2.05	3.06	2.01	92.2	89.4
440		144	4	2 790	4 000	285	700	930	23152RHA	23152RHAK	278	311	422	384	3	0.32	2.12	3.16	2.08	87.4	84.6
440		180	4	3 250	4 700	345	720	950	24152RR	24152RRK30	278	304	422	374	3	0.40	1.69	2.51	1.65	114	112
440		180	4	3 210	4 950	309	720	950	24152RHA	24152RHAK30	278	299	422	368	3	0.41	1.66	2.47	1.62	106	105
480		130	5	2 800	3 460	347	650	870	22252R	22252RK	282	326	458	419	4	0.28	2.40	3.57	2.35	110	108
480		130	5	2 790	3 430	226	650	870	22252RHA	22252RHAK	282	324	458	418	4	0.27	2.50	3.72	2.44	103	101
480		174	5	3 440	4 640	326	640	860	23252R	23252RK	282	325	458	408	4	0.40	1.69	2.51	1.65	144	140
480		174	5	3 590	4 900	280	650	860	23252RHA	23252RHAK	282	322	458	408	4	0.36	1.87	2.78	1.83	137	133
540		165	6	3 540	4 380	363	590	780	22352R	22352RK	288	346	512	453	5	0.35	1.94	2.89	1.90	196	192
540	165	6	3 900	4 620	290	580	780	22352RHA	22352RHAK	288	342	512	461	5	0.31	2.15	3.21	2.11	181	177	
280	380	75	2.1	1 160	1 960	165	760	1 000	23956R	23956RK	292	312	368	353	2	0.18	3.74	5.57	3.66	26.0	25.2

[Remark] Standard cage types used for the above bearings are shown in Table 5 earlier in this section.

Spherical roller bearings

d (280) ~ (320) mm

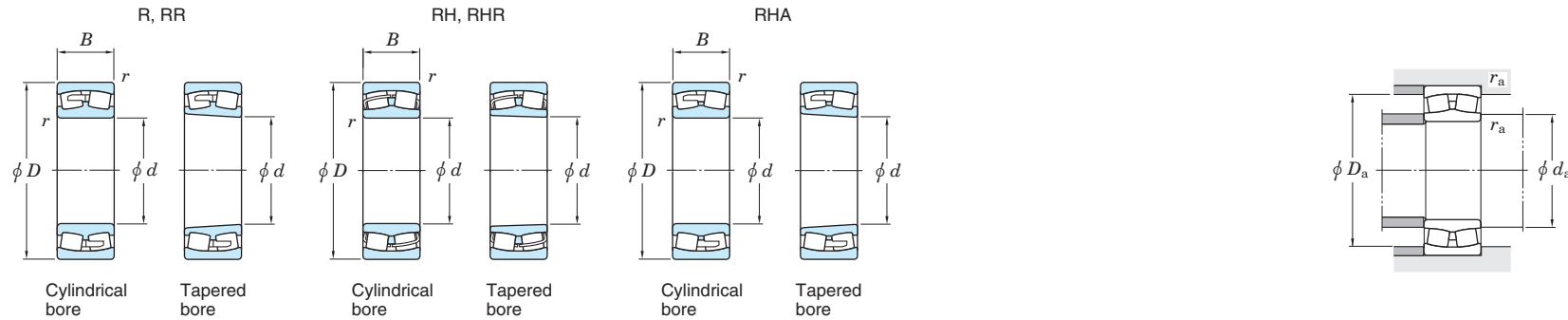


Boundary dimensions (mm)				Basic load ratings (kN)		Fatigue load limit (kN) C <sub>u</sub>	Limiting speeds (min <sup>-1</sup> )		Bearing No.		Mounting dimensions (mm)					Constant e	Axial load factors			(Refer.) Mass (kg)	
d	D	B	r <sub>min.</sub>	C <sub>r</sub>	C <sub>0r</sub>		Grease lub.	Oil lub.	Cylindrical bore	Tapered bore	d <sub>a</sub> min.	d <sub>a</sub> max.	D <sub>a</sub> max.	D <sub>a</sub> min.	r <sub>a</sub> max.		Y <sub>1</sub>	Y <sub>2</sub>	Y <sub>0</sub>	Cylindrical bore	Tapered bore
280	420	106	4	1 790	2 860	235	710	950	23056R	23056RK	298	322	402	377	3	0.25	2.74	4.08	2.68	54.5	52.9
	420	106	4	1 940	2 950	218	700	940	23056RHA	23056RHAK	298	322	402	380	3	0.24	2.87	4.27	2.80	49.8	48.2
	420	140	4	2 370	3 780	291	710	950	24056RR	24056RRK30	298	316	402	373	3	0.31	2.15	3.21	2.11	70.2	69.1
	420	140	4	2 390	4 000	287	710	950	24056RHA	24056RHAK30	298	314	402	372	3	0.31	2.20	3.28	2.15	64.0	62.9
	460	146	5	2 910	4 160	250	660	880	23156RR	23156RRK	302	332	438	407	4	0.32	2.14	3.18	2.09	98.8	95.7
	460	146	5	2 940	4 290	304	650	870	23156RHA	23156RHAK	302	331	438	406	4	0.30	2.22	3.30	2.17	93.4	90.3
	460	180	5	3 390	5 140	370	660	880	24156RR	24156RRK30	302	326	438	396	4	0.38	1.79	2.67	1.75	122	120
	460	180	5	3 320	5 240	322	660	880	24156RHA	24156RHAK30	302	321	438	390	4	0.38	1.76	2.62	1.72	113	112
	500	130	5	2 640	3 380	308	610	810	22256R	22256RK	302	347	478	438	4	0.28	2.42	3.60	2.37	114	112
	500	130	5	2 900	3 670	240	610	810	22256RHA	22256RHAK	302	346	478	440	4	0.26	2.64	3.93	2.58	106	104
	500	176	5	3 370	4 910	323	610	820	23256R	23256RK	302	345	478	421	4	0.37	1.83	2.72	1.79	153	149
	500	176	5	3 770	5 300	365	600	800	23256RHA	23256RHAK	302	343	478	430	4	0.35	1.95	2.91	1.91	145	141
	580	175	6	3 930	4 910	407	530	710	22356R	22356RK	308	372	552	486	5	0.34	1.98	2.95	1.93	229	225
	580	175	6	4 390	5 260	325	530	700	22356RHA	22356RHAK	308	367	552	495	5	0.31	2.19	3.25	2.14	212	208
300	420	90	3	1 610	2 610	220	680	910	23960R	23960RK	314	336	406	387	2.5	0.20	3.42	5.09	3.34	40.0	38.8
	460	118	4	2 190	3 480	286	630	840	23060R	23060RK	318	351	442	412	3	0.25	2.69	4.00	2.63	75.8	73.7
	460	118	4	2 370	3 700	255	630	840	23060RHA	23060RHAK	318	347	442	416	3	0.24	2.79	4.16	2.73	68.9	66.8
	460	160	4	2 950	4 690	354	640	850	24060RR	24060RRK30	318	342	442	406	3	0.33	2.04	3.04	2.00	99.5	97.9
	460	160	4	2 950	4 910	350	640	850	24060RHA	24060RHAK30	318	338	442	404	3	0.32	2.09	3.11	2.04	90.7	89.1
	500	160	5	3 450	5 030	351	590	790	23160RR	23160RRK	322	358	478	439	4	0.32	2.09	3.11	2.04	131	127
	500	160	5	3 430	4 970	345	580	780	23160RHA	23160RHAK	322	357	478	439	4	0.31	2.18	3.25	2.13	123	119
	500	200	5	4 160	6 280	433	590	790	24160RR	24160RRK30	322	349	478	425	4	0.40	1.67	2.49	1.63	162	160
	500	200	5	4 030	6 420	385	590	790	24160RHA	24160RHAK30	322	347	478	424	4	0.39	1.72	2.56	1.68	150	148
	540	140	5	3 360	4 330	412	550	740	22260R	22260RK	322	368	518	467	4	0.27	2.48	3.69	2.43	145	142
	540	140	5	3 320	4 360	284	550	740	22260RHA	22260RHAK	322	370	518	467	4	0.26	2.62	3.90	2.56	135	132
	540	192	5	4 300	5 910	401	540	720	23260R	23260RK	322	370	518	464	4	0.37	1.83	2.72	1.79	197	192
	540	192	5	4 440	6 310	429	540	720	23260RHA	23260RHAK	322	371	518	464	4	0.35	1.93	2.88	1.89	187	182
	620	185	7.5	4 890	5 430	555	470	630	22360R	22360RK	336	390	584	547	6	0.32	2.09	3.10	2.04	289	284
320	440	90	3	1 670	2 870	233	630	840	23964R	23964RK	334	358	426	408	2.5	0.19	3.61	5.38	3.53	43.0	41.7

[Remark] Standard cage types used for the above bearings are shown in Table 5 earlier in this section.

Spherical roller bearings

$d$  (320) ~ (360) mm



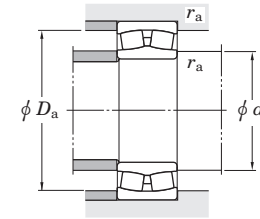
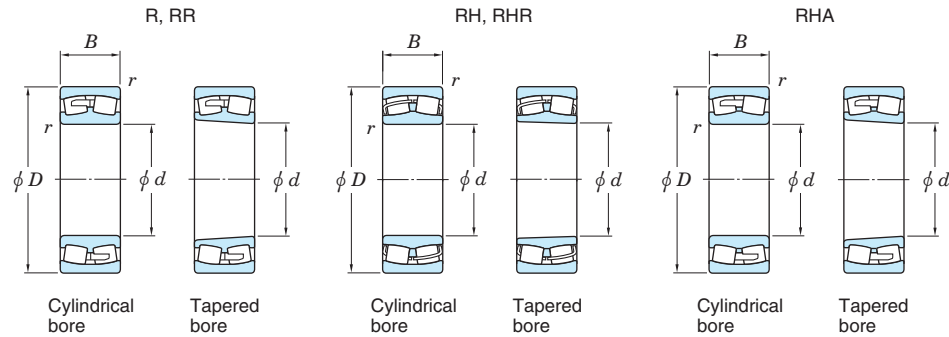
Boundary dimensions (mm)				Basic load ratings (kN)		Fatigue load limit (kN) $C_u$	Limiting speeds (min <sup>-1</sup> )		Bearing No.		Mounting dimensions (mm)					Constant $e$	Axial load factors			(Refer.) Mass (kg)	
$d$	$D$	$B$	$r_{min.}$	$C_r$	$C_{0r}$		Grease lub.	Oil lub.	Cylindrical bore	Tapered bore	$d_a$ min.	$d_a$ max.	$D_a$ max.	$D_a$ min.	$r_a$ max.		$Y_1$	$Y_2$	$Y_0$	Cylindrical bore	Tapered bore
320	480	121	4	2 290	3 740	295	590	790	23064R	23064RK	338	369	462	431	3	0.24	2.76	4.11	2.70	81.2	78.8
	480	121	4	2 490	3 850	278	590	780	23064RHA	23064RHAK	338	367	462	436	3	0.24	2.87	4.27	2.80	74.5	72.1
	480	160	4	3 020	4 920	382	590	790	24064RR	24064RRK30	338	363	462	427	3	0.31	2.16	3.22	2.11	105	103
	480	160	4	3 060	5 230	363	590	790	24064RHA	24064RHAK30	338	360	462	425	3	0.31	2.21	3.29	2.16	93.4	91.4
	540	176	5	3 650	5 700	366	530	700	23164R	23164RK	342	389	518	467	4	0.33	2.04	3.04	2.00	171	166
	540	176	5	4 040	5 960	404	530	700	23164RHA	23164RHAK	342	383	518	472	4	0.32	2.13	3.17	2.08	160	155
	540	218	5	4 680	6 950	486	530	710	24164RR	24164RRK30	342	373	518	460	4	0.39	1.72	2.56	1.68	208	205
	540	218	5	4 550	7 190	429	530	710	24164RHA	24164RHAK30	342	371	518	458	4	0.40	1.70	2.52	1.66	199	196
	580	150	5	3 420	4 540	385	490	660	22264R	22264RK	342	402	558	504	4	0.28	2.41	3.59	2.35	175	171
	580	208	5	4 550	6 550	496	500	670	23264R	23264RK	342	394	558	488	4	0.38	1.76	2.62	1.72	249	242
580	208	5	5 020	7 030	464	490	650	23264RHA	23264RHAK	342	392	558	495	4	0.36	1.90	2.83	1.86	236	229	
340	460	90	3	1 680	2 980	242	590	790	23968R	23968RK	354	377	446	426	2.5	0.18	3.82	5.69	3.74	45.0	43.6
	520	133	5	2 670	4 330	353	530	710	23068R	23068RK	362	397	498	465	4	0.25	2.69	4.00	2.63	108	105
	520	133	5	2 930	4 470	312	530	710	23068RHA	23068RHAK	362	393	498	468	4	0.24	2.80	4.18	2.74	98.7	95.7
	520	180	5	3 680	5 970	432	530	710	24068RR	24068RRK30	362	387	498	460	4	0.33	2.06	3.06	2.01	142	140
	520	180	5	3 720	6 330	430	530	710	24068RHA	24068RHAK30	362	385	498	459	4	0.32	2.11	3.14	2.06	130	128
	580	190	5	4 130	6 430	472	480	640	23168R	23168RK	362	413	558	497	4	0.34	1.97	2.93	1.93	216	210
	580	190	5	4 620	6 720	449	480	640	23168RHA	23168RHAK	362	407	558	503	4	0.32	2.11	3.14	2.06	202	196
	580	243	5	5 570	8 400	564	490	650	24168RR	24168RRK30	362	396	558	490	4	0.41	1.64	2.45	1.61	270	266
	580	243	5	5 490	8 810	449	490	650	24168RHA	24168RHAK30	362	390	558	482	4	0.42	1.61	2.39	1.57	259	255
	620	165	6	4 430	5 430	551	440	590	22268R	22268RK	368	424	592	551	5	0.28	2.43	3.61	2.37	221	216
	620	224	6	5 130	7 560	526	450	600	23268R	23268RK	368	423	592	521	5	0.38	1.77	2.63	1.73	306	297
	620	224	6	5 690	8 030	517	440	590	23268RHA	23268RHAK	368	418	592	532	5	0.36	1.88	2.81	1.84	290	281
	360	480	90	3	1 710	3 060	248	550	730	23972R	23972RK	374	399	466	447	2.5	0.17	3.95	5.88	3.86	46.5
540		134	5	2 860	4 800	375	500	660	23072R	23072RK	382	416	518	484	4	0.24	2.76	4.11	2.70	115	111
540		134	5	3 040	4 770	334	500	660	23072RHA	23072RHAK	382	414	518	489	4	0.23	2.92	4.34	2.85	105	101
540		180	5	3 810	6 300	465	500	660	24072RR	24072RRK30	382	407	518	481	4	0.31	2.15	3.21	2.11	149	147
540		180	5	3 810	6 620	446	500	660	24072RHA	24072RHAK30	382	406	518	480	4	0.30	2.22	3.30	2.17	135	133
600		192	5	4 740	7 040	459	440	590	23172R	23172RK	382	431	578	527	4	0.33	2.07	3.09	2.03	228	221

[Remark] Standard cage types used for the above bearings are shown in Table 5 earlier in this section.



Spherical roller bearings

d (360) ~ 400 mm

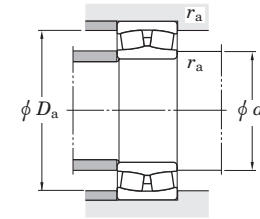
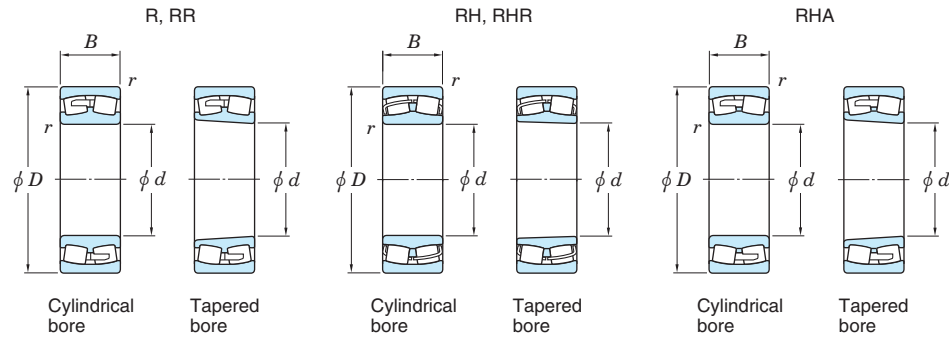


Boundary dimensions (mm)				Basic load ratings (kN)		Fatigue load limit (kN) C <sub>u</sub>	Limiting speeds (min <sup>-1</sup> )		Bearing No.		Mounting dimensions (mm)					Constant e	Axial load factors			(Refer.) Mass (kg)	
d	D	B	r <sub>min.</sub>	C <sub>r</sub>	C <sub>0r</sub>		Grease lub.	Oil lub.	Cylindrical bore	Tapered bore	d <sub>a</sub> min.	d <sub>a</sub> max.	D <sub>a</sub> max.	D <sub>a</sub> min.	r <sub>a</sub> max.		Y <sub>1</sub>	Y <sub>2</sub>	Y <sub>0</sub>	Cylindrical bore	Tapered bore
360	600	192	5	4 830	7 210	474	450	590	23172RHA	23172RHAK	382	429	578	527	4	0.31	2.19	3.25	2.14	213	206
	600	243	5	5 080	7 690	437	450	600	24172R	24172RK30	382	420	578	512	4	0.39	1.74	2.59	1.70	287	283
	600	243	5	5 580	9 180	517	460	610	24172RHA	24172RHAK30	382	413	578	505	4	0.40	1.69	2.51	1.65	274	270
	650	170	6	4 710	5 830	583	410	550	22272R	22272RK	388	447	622	579	5	0.27	2.47	3.68	2.42	248	243
	650	232	6	6 080	8 810	548	410	540	23272R	23272RK	388	446	622	555	5	0.37	1.83	2.72	1.79	346	336
	650	232	6	6 220	9 050	591	410	550	23272RHA	23272RHAK	388	442	622	558	5	0.35	1.92	2.85	1.87	328	318
380	520	106	4	2 220	3 940	295	500	660	23976R	23976RK	398	425	502	481	3	0.19	3.62	5.39	3.54	70.0	67.9
	560	135	5	2 910	4 970	355	470	630	23076R	23076RK	402	433	538	503	4	0.24	2.79	4.16	2.73	122	118
	560	135	5	3 160	5 080	354	460	620	23076RHA	23076RHAK	402	434	538	512	4	0.22	3.03	4.51	2.96	112	108
	560	180	5	3 900	6 590	486	470	620	24076RR	24076RRK30	402	428	538	502	4	0.30	2.26	3.36	2.21	156	154
	560	180	5	3 900	6 910	454	470	620	24076RHA	24076RHAK30	402	426	538	502	4	0.29	2.32	3.45	2.27	142	139
	620	194	5	4 520	7 320	442	420	560	23176R	23176RK	402	454	598	540	4	0.31	2.18	3.24	2.13	240	233
	620	194	5	5 030	7 700	503	420	560	23176RHA	23176RHAK	402	450	598	547	4	0.30	2.26	3.36	2.21	224	217
	620	243	5	5 300	8 220	467	430	570	24176R	24176RK30	402	439	598	529	4	0.38	1.78	2.65	1.74	302	297
	620	243	5	5 870	9 840	561	420	560	24176RHA	24176RHAK30	402	438	598	534	4	0.38	1.78	2.65	1.74	288	283
	680	240	6	6 510	9 500	590	380	500	23276R	23276RK	408	469	652	583	5	0.36	1.85	2.76	1.81	386	375
680	240	6	6 660	9 760	622	380	510	23276RHA	23276RHAK	408	466	652	586	5	0.35	1.94	2.89	1.90	365	354	
400	540	106	4	2 350	4 300	320	470	620	23980R	23980RK	418	443	522	500	3	0.18	3.76	5.59	3.67	73.0	70.7
	600	148	5	3 390	5 790	408	420	560	23080R	23080RK	422	462	578	540	4	0.24	2.84	4.23	2.78	155	151
	600	148	5	3 690	5 860	398	420	560	23080RHA	23080RHAK	422	460	578	543	4	0.23	2.94	4.37	2.87	142	138
	600	200	5	4 820	8 110	444	430	570	24080R	24080RK30	422	450	578	531	4	0.32	2.09	3.12	2.05	206	203
	600	200	5	4 620	8 140	535	420	570	24080RHA	24080RHAK30	422	450	578	534	4	0.31	2.21	3.29	2.16	192	189
	650	200	6	4 730	7 780	521	390	520	23180R	23180RK	428	476	622	564	5	0.31	2.19	3.25	2.14	273	265
	650	200	6	5 410	8 300	542	390	520	23180RHA	23180RHAK	428	473	622	574	5	0.29	2.30	3.43	2.25	255	247
	650	250	6	5 840	9 140	499	390	530	24180R	24180RK30	428	461	622	558	5	0.37	1.82	2.70	1.78	338	333
	650	250	6	6 290	10 600	600	390	520	24180RHA	24180RHAK30	428	462	622	558	5	0.37	1.82	2.71	1.78	322	317
	720	256	6	6 540	9 850	590	350	470	23280R	23280RK	428	496	692	605	5	0.37	1.80	2.69	1.76	468	454
	720	256	6	7 320	10 600	665	350	460	23280RHA	23280RHAK	428	489	692	619	5	0.35	1.92	2.86	1.88	441	427

[Remark] Standard cage types used for the above bearings are shown in Table 5 earlier in this section.

Spherical roller bearings

d 420 ~ (460) mm

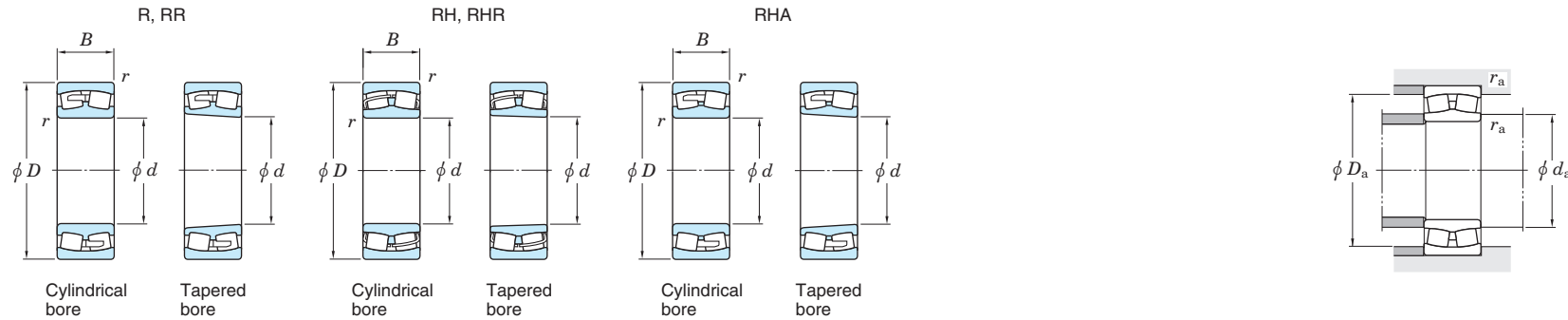


Boundary dimensions (mm)				Basic load ratings (kN)		Fatigue load limit (kN) $C_u$	Limiting speeds (min <sup>-1</sup> )		Bearing No.		Mounting dimensions (mm)					Constant $e$	Axial load factors			(Refer.) Mass (kg)	
$d$	$D$	$B$	$r_{min.}$	$C_r$	$C_{0r}$		Grease lub.	Oil lub.	Cylindrical bore	Tapered bore	$d_a$ min.	$d_a$ max.	$D_a$ max.	$D_a$ min.	$r_a$ max.		$Y_1$	$Y_2$	$Y_0$	Cylindrical bore	Tapered bore
420	560	106	4	2 330	4 320	331	430	580	23984R	23984RK	438	465	542	522	3	0.17	3.91	5.82	3.82	76.0	73.6
	620	150	5	3 500	6 120	412	400	530	23084R	23084RK	442	483	598	560	4	0.23	2.90	4.31	2.83	164	159
	620	150	5	3 820	6 230	425	400	530	23084RHA	23084RHAK	442	480	598	563	4	0.22	3.02	4.49	2.95	150	145
	620	200	5	4 510	7 600	438	400	530	24084R	24084RK30	442	471	598	554	4	0.30	2.23	3.32	2.18	212	209
	620	200	5	4 730	8 490	555	400	530	24084RHA	24084RHAK30	442	471	598	554	4	0.29	2.31	3.44	2.26	198	195
	700	224	6	5 620	9 110	583	350	470	23184R	23184RK	448	506	672	604	5	0.33	2.03	3.02	1.98	363	352
	700	224	6	6 330	9 630	616	350	470	23184RHA	23184RHAK	448	500	672	615	5	0.31	2.19	3.25	2.14	339	328
	700	280	6	6 840	10 600	574	360	480	24184R	24184RK30	448	486	672	593	5	0.40	1.71	2.54	1.67	445	438
	700	280	6	7 420	12 400	685	350	470	24184RHA	24184RHAK30	448	486	672	596	5	0.39	1.72	2.56	1.68	425	418
	760	272	7.5	8 130	11 500	754	320	430	23284R	23284RK	456	514	724	652	6	0.37	1.84	2.74	1.80	556	540
760	272	7.5	8 230	11 900	735	320	430	23284RHA	23284RHAK	456	512	724	652	6	0.36	1.90	2.83	1.86	525	508	
440	600	118	4	2 910	5 330	387	400	530	23988R	23988RK	458	490	582	554	3	0.18	3.75	5.58	3.66	101	97.8
	650	157	6	3 790	6 540	455	370	500	23088R	23088RK	468	501	622	584	5	0.24	2.76	4.11	2.70	188	183
	650	157	6	4 230	6 910	465	370	490	23088RHA	23088RHAK	468	504	622	591	5	0.22	3.04	4.53	2.97	172	167
	650	212	6	4 910	8 320	475	370	490	24088R	24088RK30	468	494	622	579	5	0.29	2.35	3.50	2.30	247	243
	650	212	6	5 290	9 560	618	370	490	24088RHA	24088RHAK30	468	492	622	575	5	0.30	2.28	3.39	2.23	231	227
	720	226	6	5 800	9 600	591	330	440	23188R	23188RK	468	526	692	625	5	0.33	2.08	3.09	2.03	378	366
	720	226	6	6 590	10 300	655	330	440	23188RHA	23188RHAK	468	521	692	636	5	0.30	2.25	3.34	2.20	353	341
	720	280	6	7 080	11 200	589	340	450	24188R	24188RK30	468	507	692	615	5	0.38	1.76	2.62	1.72	460	453
	720	280	6	7 540	12 900	707	330	440	24188RHA	24188RHAK30	468	509	692	616	5	0.38	1.79	2.67	1.75	439	432
	790	280	7.5	8 580	12 300	793	300	400	23288R	23288RK	476	540	754	684	6	0.36	1.86	2.77	1.82	613	595
790	280	7.5	8 670	12 700	776	300	390	23288RHA	23288RHAK	476	539	754	682	6	0.35	1.93	2.88	1.89	580	562	
460	600	90	3	1 800	3 660	306	350	460	23896R	23896RK	476	519	586	568	2.5	0.13	5.06	7.53	4.95	60.4	58.4
	620	118	4	2 890	5 350	404	370	500	23992R	23992RK	478	512	602	577	3	0.17	3.89	5.79	3.80	107	104
	680	163	6	4 060	7 170	480	340	460	23092R	23092RK	488	529	652	613	5	0.23	2.92	4.34	2.85	215	209
	680	163	6	4 520	7 430	497	340	460	23092RHA	23092RHAK	488	527	652	618	5	0.22	3.04	4.53	2.97	197	191
	680	218	6	5 740	10 100	536	340	460	24092R	24092RK30	488	519	652	607	5	0.30	2.23	3.32	2.18	277	272
	680	218	6	5 660	10 300	656	340	460	24092RHA	24092RHAK30	488	518	652	604	5	0.29	2.33	3.46	2.27	259	254
	760	240	7.5	6 510	10 800	648	310	410	23192R	23192RK	496	552	724	656	6	0.33	2.07	3.09	2.03	450	436

[Remark] Standard cage types used for the above bearings are shown in Table 5 earlier in this section.

Spherical roller bearings

d (460) ~ 500 mm

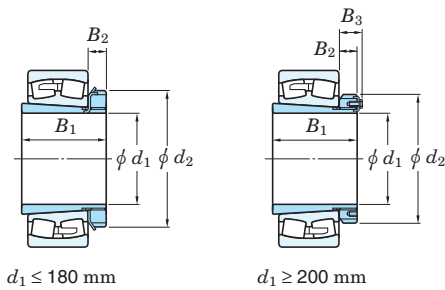


Boundary dimensions (mm)				Basic load ratings (kN)		Fatigue load limit (kN) $C_u$	Limiting speeds (min <sup>-1</sup> )		Bearing No.		Mounting dimensions (mm)					Constant $e$	Axial load factors			(Refer.) Mass (kg)	
$d$	$D$	$B$	$r_{min.}$	$C_r$	$C_{0r}$		Grease lub.	Oil lub.	Cylindrical bore	Tapered bore	$d_a$ min.	$d_a$ max.	$D_a$ max.	$D_a$ min.	$r_a$ max.		$Y_1$	$Y_2$	$Y_0$	Cylindrical bore	Tapered bore
<b>460</b>	760	240	7.5	7 240	11 200	697	300	400	<b>23192RHA</b>	<b>23192RHAK</b>	496	546	724	669	6	0.30	2.22	3.31	2.17	420	406
	760	300	7.5	7 320	12 200	597	310	410	<b>24192R</b>	<b>24192RK30</b>	496	537	724	647	6	0.35	1.95	2.90	1.91	550	541
	760	300	7.5	8 390	14 200	746	310	410	<b>24192RHA</b>	<b>24192RHAK30</b>	496	535	724	651	6	0.38	1.75	2.61	1.72	525	516
	830	296	7.5	9 520	13 700	867	270	370	<b>23292R</b>	<b>23292RK</b>	496	567	794	718	6	0.36	1.85	2.76	1.81	720	699
	830	296	7.5	9 600	14 200	856	270	360	<b>23292RHA</b>	<b>23292RHAK</b>	496	564	794	714	6	0.35	1.92	2.85	1.87	679	658
	<b>480</b>	650	128	5	3 290	6 130	446	350	460	<b>23996R</b>	<b>23996RK</b>	502	534	628	603	4	0.18	3.75	5.59	3.67	123
	700	165	6	4 190	7 540	505	320	430	<b>23096R</b>	<b>23096RK</b>	508	549	672	633	5	0.22	3.01	4.47	2.94	225	218
	700	165	6	4 670	7 860	532	320	430	<b>23096RHA</b>	<b>23096RHAK</b>	508	548	672	639	5	0.22	3.12	4.64	3.05	206	199
	700	218	6	5 540	9 650	514	320	430	<b>24096R</b>	<b>24096RK30</b>	508	539	672	626	5	0.29	2.32	3.45	2.26	287	282
	700	218	6	5 800	10 700	492	320	430	<b>24096RHA</b>	<b>24096RHAK30</b>	508	537	672	626	5	0.28	2.41	3.59	2.35	268	263
	790	248	7.5	6 840	11 500	698	280	380	<b>23196R</b>	<b>23196RK</b>	516	579	754	685	6	0.32	2.09	3.12	2.05	503	488
	790	248	7.5	7 740	12 000	638	280	380	<b>23196RHA</b>	<b>23196RHAK</b>	516	570	754	697	6	0.30	2.24	3.34	2.19	470	455
	790	308	7.5	8 730	14 800	707	280	380	<b>24196R</b>	<b>24196RK30</b>	516	560	754	678	6	0.39	1.74	2.59	1.70	606	597
	790	308	7.5	9 880	15 900	792	290	380	<b>24196RHA</b>	<b>24196RHAK30</b>	516	553	754	684	6	0.38	1.78	2.65	1.74	580	568
	870	310	7.5	10 500	15 100	953	250	340	<b>23296R</b>	<b>23296RK</b>	516	588	834	745	6	0.36	1.85	2.75	1.81	831	807
	870	310	7.5	10 600	15 700	791	250	340	<b>23296RHA</b>	<b>23296RHAK</b>	516	589	834	748	6	0.35	1.91	2.85	1.87	785	761
<b>500</b>	670	128	5	3 330	6 310	447	330	440	<b>239/500R</b>	<b>239/500RK</b>	522	553	648	622	4	0.17	3.87	5.76	3.79	131	127
	720	167	6	4 490	8 090	561	310	410	<b>230/500R</b>	<b>230/500RK</b>	528	568	692	656	5	0.23	2.94	4.37	2.87	235	228
	720	218	6	5 620	10 300	545	310	410	<b>240/500R</b>	<b>240/500RK30</b>	528	561	692	647	5	0.28	2.39	3.56	2.34	297	292
	830	264	7.5	7 750	13 000	708	260	350	<b>231/500R</b>	<b>231/500RK</b>	536	601	794	714	6	0.33	2.05	3.05	2.00	595	577
	830	325	7.5	9 350	15 900	763	260	350	<b>241/500R</b>	<b>241/500RK30</b>	536	591	794	712	6	0.36	1.85	2.76	1.81	712	701
	920	336	7.5	11 000	16 700	908	230	310	<b>232/500R</b>	<b>232/500RK</b>	536	622	884	774	6	0.39	1.74	2.59	1.70	1 020	992

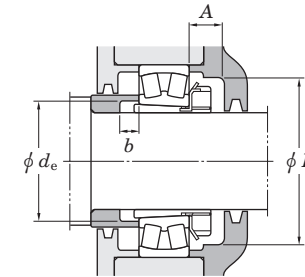
[Remark] Standard cage types used for the above bearings are shown in Table 5 earlier in this section.

Adapter assemblies for spherical roller bearings

$d_1$  20 ~ 65 mm



$d_1$  70 ~ 110 mm

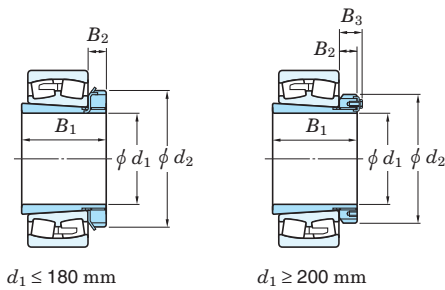


Boundary dimensions (mm)					Brg. bore $d$ (mm)	Designations Bearing + adapter ass'y	Mounting dimensions (mm)				Mass Brg.+adapter ass'y (kg)	(Refer.)			
$d_1$	$B_1$	$d_2$	$B_2$	$B_3$			A min.	K min.	$d_e$ min.	$b$ min.		Adapter sleeve No.	Locknut No.		
20	29	38	8	—	25	22205RHRK+H305X	15	45	29	5	0.269	A305X	AN05		
25	31	45	8	—	30	22206RHRK+H306X 21306RHK+H306X	15	50	34	5	0.404 0.538	A306X A306X	AN06 AN06		
		31	45	8			—								
30	35	52	9	—	35	22207RHRK+H307X 21307RHK+H307X	17	58	39	5	0.610 0.725	A307X A307X	AN07 AN07		
		35	52	9			—								
35	36	58	10	—	40	22208RHRK+H308X 21308RHK+H308X 22308RHRK+H2308X	17	65	44	5	0.793 0.972 1.30	A308X A308X A2308X	AN08 AN08 AN08		
		36	58	10			—								
		46	58	10			—								
40	39	65	11	—	45	22209RHRK+H309X 21309RHK+H309X 22309RHRK+H2309X	17	72	49	8	0.855 1.31 1.70	A309X A309X A2309X	AN09 AN09 AN09		
		39	65	11			—								
		50	65	11			—								
45	42	70	12	—	50	22210RHRK+H310X 21310RHK+H310X 22310RHRK+H2310X	19	76	54	10	0.953 1.67 2.26	A310X A310X A2310X	AN10 AN10 AN10		
		42	70	12			—								
		55	70	12			—								
50	45	75	12	—	55	22211RHRK+H311X 21311RHK+H311X 22311RHRK+H2311X	19	85	60	11	1.22 2.04 2.80	A311X A311X A2311X	AN11 AN11 AN11		
		45	75	12			—								
		59	75	12			—								
55	47	80	13	—	60	22212RHRK+H312X 21312RHK+H312X 22312RHRK+H2312X	20	90	65	9	1.59 2.50 3.50	A312X A312X A2312X	AN12 AN12 AN12		
		47	80	13			—								
		62	80	13			—								
60	50	85	14	—	65	22213RHRK+H313X 21313RHK+H313X 22313RHRK+H2313X	21	96	70	8	2.01 3.07 4.17	A313X A313X A2313X	AN13 AN13 AN13		
		50	85	14			—								
		65	85	14			—								
65	55	98	15	—	75	22215RHRK+H315X 21315RHK+H315X 22315RHRK+H2315X	23	110	80	12	2.58 4.65 6.44	A315X A315X A2315X	AN15 AN15 AN15		
		55	98	15			—								
		73	98	15			—								

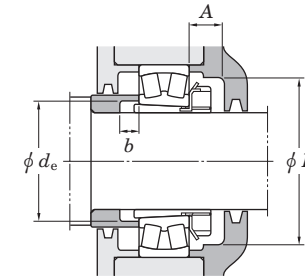
Boundary dimensions (mm)					Brg. bore $d$ (mm)	Designations Bearing + adapter ass'y	Mounting dimensions (mm)				Mass Brg.+adapter ass'y (kg)	(Refer.)			
$d_1$	$B_1$	$d_2$	$B_2$	$B_3$			A min.	K min.	$d_e$ min.	$b$ min.		Adapter sleeve No.	Locknut No.		
70	59	105	17	—	80	22216RHRK+H316X 21316RHK+H316X 22316RHRK+H2316X	25	120	86	12	3.22 5.56 7.64	A316X A316X A2316X	AN16 AN16 AN16		
		59	105	17			—								
		78	105	17			—								
75	63	110	18	—	85	22217RHRK+H317X 21317RHK+H317X 22317RHRK+H2317X	27	128	91	12	3.93 6.49 8.83	A317X A317X A2317X	AN17 AN17 AN17		
		63	110	18			—								
		82	110	18			—								
80	65	120	18	—	90	22218RHRK+H318X 23218RHK+H2318X 21318RHK+H318X 22318RHRK+H2318X	28	139	96	10	4.88 6.20 7.56 10.3	A318X A2318X A318X A2318X	AN18 AN18 AN18 AN18		
		86	120	18			—								
		65	120	18			—								
		86	120	18			—								
85	68	125	19	—	95	22219RHRK+H319X 21319RHK+H319X 22319RHRK+H2319X	29	145	102	9	5.77 8.68 12.0	A319X A319X A2319X	AN19 AN19 AN19		
		68	125	19			—								
		90	125	19			—								
90	71	130	20	—	100	22220RHRK+H320X 23220RHK+H2320X 21320RHK+H320X 22320RHRK+H2320X	30	150	107	8	6.80 8.94 10.5 15.2	A320X A2320X A320X A2320X	AN20 AN20 AN20 AN20		
		97	130	20			—								
		71	130	20			—								
		97	130	20			—								
100	81	145	21	—	110	23122RHK+H3122X 22222RHRK+H322X 23222RHK+H2322X 21322RHK+H322X 22322RHRK+H2322X	32	170	117	7	7.91 9.50 12.4 14.0 20.6	A3122X A322X A2322X A322X A2322X	AN22 AN22 AN22 AN22 AN22		
		77	145	21			—								
		105	145	21			—								
		77	145	21			—								
		105	145	21			—								
110	72	145	22	—	120	23024RHK+H3024X 23124RHK+H3124X 22224RHRK+H3124X 23224RHK+H2324X 22324RHRK+H2324X	33	180	127	7	6.12 10.5 11.9 15.1 25.6	A3024 A3124 A3124 A2324 A2324	ANL24 AN24 AN24 AN24 AN24		
		88	155	22			—								
		88	155	22			—								
		112	155	22			—								
		112	155	22			—								

Adapter assemblies for spherical roller bearings

$d_1$  115 ~ (150) mm



$d_1$  (150) ~ (180) mm

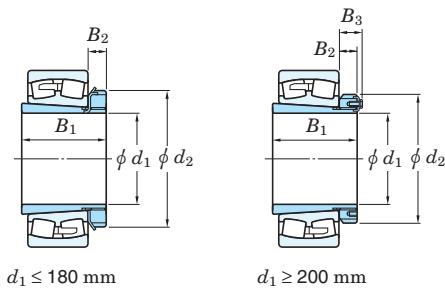


Boundary dimensions (mm)					Brg. bore $d$ (mm)	Designations Bearing + adapter ass'y	Mounting dimensions (mm)				Mass Brg.+adapter ass'y (kg)	(Refer.)	
$d_1$	$B_1$	$d_2$	$B_2$	$B_3$			A min.	K min.	$d_e$ min.	$b$ min.		Adapter sleeve No.	Locknut No.
<b>115</b>	80	155	23	—	130	23026RHK+H3026	34	190	137	8	9.01	A3026	ANL26
	92	165	23	—	130	23126RHK+H3126	34	190	138	8	12.3	A3126	AN26
	92	165	23	—	130	22226RHRK+H3126	34	190	138	8	15.1	A3126	AN26
	121	165	23	—	130	23226RHK+H2326	34	190	142	21	18.8	A2326	AN26
	121	165	23	—	130	22326RHRK+H2326	34	190	142	8	32.7	A2326	AN26
<b>125</b>	82	165	24	—	140	23028RHK+H3028	36	205	147	8	9.79	A3028	ANL28
	97	180	24	—	140	23128RHK+H3128	36	205	149	8	14.9	A3128	AN28
	97	180	24	—	140	22228RHRK+H3128	36	205	149	8	18.8	A3128	AN28
	131	180	24	—	140	23228RHK+H2328	36	205	152	22	24.3	A2328	AN28
	131	180	24	—	140	22328RHK+H2328	36	205	152	8	40.8	A2328	AN28
<b>135</b>	87	180	26	—	150	23030RHK+H3030	37	220	158	8	11.9	A3030	ANL30
	111	195	26	—	150	23130RHK+H3130	37	220	160	8	21.7	A3130	AN30
	111	195	26	—	150	22230RHRK+H3130	37	220	160	15	24.3	A3130	AN30
	139	195	26	—	150	23230RHK+H2330	37	220	163	20	30.8	A2330	AN30
	139	195	26	—	150	22330RHK+H2330	37	220	163	8	46.4	A2330	AN30
<b>140</b>	93	190	28	—	160	23032RHK+H3032	39	230	168	8	15.0	A3032	ANL32
	119	210	28	—	160	23132RHK+H3132	39	230	170	8	27.9	A3132	AN32
	119	210	28	—	160	22232RHK+H3132	39	230	170	14	30.6	A3132	AN32
	119	210	28	—	160	22232RHAK+H3132	39	230	170	14	29.1	A3132	AN32
	147	210	28	—	160	23232RHK+H2332	39	230	174	18	39.6	A2332	AN32
	147	210	28	—	160	23232RHAK+H2332	39	230	174	18	38.0	A2332	AN32
	147	210	28	—	160	22332RHK+H2332	39	230	174	8	60.5	A2332	AN32
	147	210	28	—	160	22332RHAK+H2332	39	230	174	8	56.6	A2332	AN32
<b>150</b>	101	200	29	—	170	23034RHK+H3034	40	250	179	8	19.2	A3034	ANL34
	122	220	29	—	170	23134RHK+H3134	40	250	180	8	30.0	A3134	AN34
	122	220	29	—	170	22234RHK+H3134	40	250	180	10	37.2	A3134	AN34
	122	220	29	—	170	22234RHAK+H3134	40	250	180	10	35.3	A3134	AN34

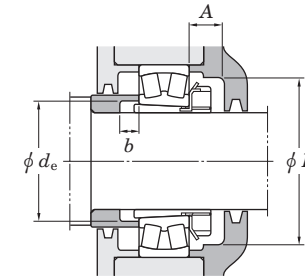
Boundary dimensions (mm)					Brg. bore $d$ (mm)	Designations Bearing + adapter ass'y	Mounting dimensions (mm)				Mass Brg.+adapter ass'y (kg)	(Refer.)		
$d_1$	$B_1$	$d_2$	$B_2$	$B_3$			A min.	K min.	$d_e$ min.	$b$ min.		Adapter sleeve No.	Locknut No.	
<b>150</b>	154	220	29	—	170	23234RRK+H2334	40	250	185	18	47.2	A2334	AN34	
	154	220	29	—	170	23234RHAK+H2334	40	250	185	18	45.3	A2334	AN34	
	154	220	29	—	170	22334RHK+H2334	40	250	185	8	71.5	A2334	AN34	
	154	220	29	—	170	22334RHAK+H2334	40	250	185	8	66.8	A2334	AN34	
<b>160</b>	109	210	30	—	180	23036RHK+H3036	41	260	189	8	24.2	A3036	ANL36	
	131	230	30	—	180	23136RHK+H3136	41	260	191	8	37.1	A3136	AN36	
	131	230	30	—	180	23136RHAK+H3136	41	260	191	8	35.2	A3136	AN36	
	131	230	30	—	180	22236RHK+H3136	41	260	191	18	39.4	A3136	AN36	
	131	230	30	—	180	22236RHAK+H3136	41	260	191	18	37.4	A3136	AN36	
	161	230	30	—	180	23236RRK+H2336	41	260	195	22	50.5	A2336	AN36	
	161	230	30	—	180	23236RHAK+H2336	41	260	195	22	48.4	A2336	AN36	
	161	230	30	—	180	22336RHK+H2336	41	260	195	8	81.8	A2336	AN36	
<b>170</b>	112	220	31	—	190	23038RHK+H3038	43	270	199	9	26.1	A3038	ANL38	
	112	220	31	—	190	23038RHAK+H3038	43	270	199	9	24.5	A3038	ANL38	
	141	240	31	—	190	23138RHK+H3138	43	270	202	9	45.3	A3138	AN38	
	141	240	31	—	190	23138RHAK+H3138	43	270	202	9	43.0	A3138	AN38	
	141	240	31	—	190	22238RHK+H3138	43	270	202	21	47.5	A3138	AN38	
	141	240	31	—	190	22238RHAK+H3138	43	270	202	21	45.0	A3138	AN38	
	169	240	31	—	190	23238RRK+H2338	43	270	206	21	59.2	A2338	AN38	
	169	240	31	—	190	23238RHAK+H2338	43	270	206	21	56.7	A2338	AN38	
	169	240	31	—	190	22338RHK+H2338	43	270	206	9	95.6	A2338	AN38	
	169	240	31	—	190	22338RHAK+H2338	43	270	206	9	89.2	A2338	AN38	
	<b>180</b>	120	240	32	—	200	23040RHK+H3040	46	280	210	10	32.8	A3040	ANL40
		120	240	32	—	200	23040RHAK+H3040	46	280	210	10	30.7	A3040	ANL40
150		250	32	—	200	23140RRK+H3140	46	280	212	10	54.7	A3140	AN40	
150		250	32	—	200	23140RHAK+H3140	46	280	212	10	51.8	A3140	AN40	
150		250	32	—	200	22240RRK+H3140	46	280	212	24	56.3	A3140	AN40	

Adapter assemblies for spherical roller bearings

$d_1$  (180) ~ (240) mm



$d_1$  (240) ~ (300) mm

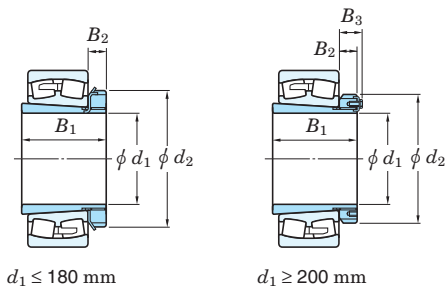


Boundary dimensions (mm)					Brg. bore $d$ (mm)	Designations Bearing + adapter ass'y	Mounting dimensions (mm)				Mass Brg.+adapter ass'y (kg)	(Refer.)	
$d_1$	$B_1$	$d_2$	$B_2$	$B_3$			A min.	K min.	$d_e$ min.	$b$ min.		Adapter sleeve No.	Locknut No.
<b>180</b>	150	250	32	—	200	22240RHAK+H3140	46	280	212	24	53.3	A3140	AN40
	176	250	32	—	200	23240RK+H2340	46	280	216	20	71.0	A2340	AN40
	176	250	32	—	200	23240RHAK+H2340	46	280	216	20	68.0	A2340	AN40
	176	250	32	—	200	22340RK+H2340	46	280	216	10	108	A2340	AN40
	176	250	32	—	200	22340RHAK+H2340	46	280	216	10	101	A2340	AN40
	<b>200</b>	128	260	30	41	220	23044RK+H3044	—	—	231	12	41.4	A3044
128		260	30	41	220	23044RHAK+H3044	—	—	231	12	38.7	A3044	ANL44
158		280	32	44	220	23144RK+H3144	—	—	233	10	68.4	A3144	AN44
158		280	32	44	220	23144RHAK+H3144	—	—	233	10	64.8	A3144	AN44
158		280	32	44	220	22244RRK+H3144	—	—	233	22	76.9	A3144	AN44
158		280	32	44	220	22244RHAK+H3144	—	—	233	22	72.7	A3144	AN44
183		280	32	44	220	23244RK+H2344	—	—	236	11	96.5	A2344	AN44
183		280	32	44	220	23244RHAK+H2344	—	—	236	11	92.3	A2344	AN44
183		280	32	44	220	22344RK+H2344	—	—	236	10	139	A2344	AN44
183		280	32	44	220	22344RHAK+H2344	—	—	236	10	130	A2344	AN44
<b>220</b>	133	290	34	46	240	23048RRK+H3048	—	—	251	11	47.7	A3048	ANL48
	133	290	34	46	240	23048RHAK+H3048	—	—	251	11	44.8	A3048	ANL48
	169	300	34	46	240	23148RRK+H3148	—	—	254	11	83.6	A3148	AN48
	169	300	34	46	240	23148RHAK+H3148	—	—	254	11	79.1	A3148	AN48
	169	300	34	46	240	22248RK+H3148	—	—	254	19	101	A3148	AN48
	169	300	34	46	240	22248RHAK+H3148	—	—	254	19	95.6	A3148	AN48
	196	300	34	46	240	23248RRK+H2348	—	—	257	6	128	A2348	AN48
	196	300	34	46	240	23248RHAK+H2348	—	—	257	6	122	A2348	AN48
	196	300	34	46	240	22348RK+H2348	—	—	257	11	175	A2348	AN48
	196	300	34	46	240	22348RHAK+H2348	—	—	257	11	163	A2348	AN48
<b>240</b>	147	310	34	46	260	23052RK+H3052	—	—	272	13	65.4	A3052	ANL52
	147	310	34	46	260	23052RHAK+H3052	—	—	272	13	61.0	A3052	ANL52
	187	330	36	49	260	23152RRK+H3152	—	—	276	11	114	A3152	AN52

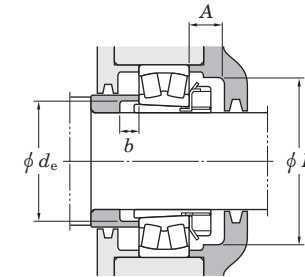
Boundary dimensions (mm)					Brg. bore $d$ (mm)	Designations Bearing + adapter ass'y	Mounting dimensions (mm)				Mass Brg.+adapter ass'y (kg)	(Refer.)		
$d_1$	$B_1$	$d_2$	$B_2$	$B_3$			A min.	K min.	$d_e$ min.	$b$ min.		Adapter sleeve No.	Locknut No.	
<b>240</b>	187	330	36	49	260	23152RHAK+H3152	—	—	276	11	108	A3152	AN52	
	187	330	36	49	260	22252RK+H3152	—	—	276	25	131	A3152	AN52	
	187	330	36	49	260	22252RHAK+H3152	—	—	276	25	124	A3152	AN52	
	208	330	36	49	260	23252RK+H2352	—	—	278	2	165	A2352	AN52	
	208	330	36	49	260	23252RHAK+H2352	—	—	278	2	158	A2352	AN52	
	208	330	36	49	260	22352RK+H2352	—	—	278	11	217	A2352	AN52	
	208	330	36	49	260	22352RHAK+H2352	—	—	278	11	202	A2352	AN52	
	<b>260</b>	152	330	38	50	280	23056RK+H3056	—	—	292	12	71.5	A3056	ANL56
		152	330	38	50	280	23056RHAK+H3056	—	—	292	12	66.8	A3056	ANL56
192		350	38	51	280	23156RRK+H3156	—	—	296	12	123	A3156	AN56	
192		350	38	51	280	23156RHAK+H3156	—	—	296	12	116	A3156	AN56	
192		350	38	51	280	22256RK+H3156	—	—	296	28	138	A3156	AN56	
192		350	38	51	280	22256RHAK+H3156	—	—	296	28	130	A3156	AN56	
221		350	38	51	280	23256RK+H2356	—	—	299	11	178	A2356	AN56	
221		350	38	51	280	23256RHAK+H2356	—	—	299	11	170	A2356	AN56	
221		350	38	51	280	22356RK+H2356	—	—	299	12	254	A2356	AN56	
221		350	38	51	280	22356RHAK+H2356	—	—	299	12	237	A2356	AN56	
<b>280</b>	168	360	42	54	300	23060RK+H3060	—	—	313	12	97.7	A3060	ANL60	
	168	360	42	54	300	23060RHAK+H3060	—	—	313	12	90.8	A3060	ANL60	
	208	380	40	53	300	23160RRK+H3160	—	—	317	12	159	A3160	AN60	
	208	380	40	53	300	23160RHAK+H3160	—	—	317	12	150	A3160	AN60	
	208	380	40	53	300	22260RK+H3160	—	—	317	32	173	A3160	AN60	
	208	380	40	53	300	22260RHAK+H3160	—	—	317	32	163	A3160	AN60	
	240	380	40	53	300	23260RK+H3260	—	—	321	12	227	A3260	AN60	
	240	380	40	53	300	23260RHAK+H3260	—	—	321	12	217	A3260	AN60	
	<b>300</b>	171	380	42	55	320	23064RK+H3064	—	—	334	13	105	A3064	ANL64
171		380	42	55	320	23064RHAK+H3064	—	—	334	13	98.1	A3064	ANL64	
226		400	42	56	320	23164RK+H3164	—	—	339	13	202	A3164	AN64	

Adapter assemblies for spherical roller bearings

$d_1$  (300) ~ 380 mm



$d_1$  400 ~ 470 mm



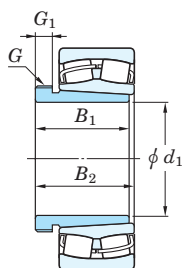
Boundary dimensions (mm)					Brg. bore $d$ (mm)	Designations Bearing + adapter ass'y	Mounting dimensions (mm)				Mass Brg.+adapter ass'y (kg)	(Refer.)	
$d_1$	$B_1$	$d_2$	$B_2$	$B_3$			A min.	K min.	$d_e$ min.	$b$ min.		Adapter sleeve No.	Locknut No.
<b>300</b>	226	400	42	56	320	23164RHAK+H3164	—	—	339	13	191	A3164	AN64
	226	400	42	56	320	22264RK+H3164	—	—	339	39	207	A3164	AN64
	258	400	42	56	320	23264RK+H3264	—	—	343	13	283	A3264	AN64
	258	400	42	56	320	23264RHAK+H3264	—	—	343	13	270	A3264	AN64
<b>320</b>	187	400	45	58	340	23068RK+H3068	—	—	355	14	135	A3068	ANL68
	187	400	45	58	340	23068RHAK+H3068	—	—	355	14	126	A3068	ANL68
	254	440	55	72	340	23168RK+H3168	—	—	360	14	262	A3168	AN68
	254	440	55	72	340	23168RHAK+H3168	—	—	360	14	248	A3168	AN68
	288	440	55	72	340	23268RK+H3268	—	—	364	14	355	A3268	AN68
	288	440	55	72	340	23268RHAK+H3268	—	—	364	14	339	A3268	AN68
<b>340</b>	188	420	45	58	360	23072RK+H3072	—	—	375	14	143	A3072	ANL72
	188	420	45	58	360	23072RHAK+H3072	—	—	375	14	133	A3072	ANL72
	259	460	58	75	360	23172RK+H3172	—	—	380	14	278	A3172	AN72
	259	460	58	75	360	23172RHAK+H3172	—	—	380	14	263	A3172	AN72
	299	460	58	75	360	23272RK+H3272	—	—	385	14	400	A3272	AN72
	299	460	58	75	360	23272RHAK+H3272	—	—	385	14	382	A3272	AN72
<b>360</b>	193	450	48	62	380	23076RK+H3076	—	—	396	15	156	A3076	ANL76
	193	450	48	62	380	23076RHAK+H3076	—	—	396	15	146	A3076	ANL76
	264	490	60	77	380	23176RK+H3176	—	—	401	15	298	A3176	AN76
	264	490	60	77	380	23176RHAK+H3176	—	—	401	15	282	A3176	AN76
	310	490	60	77	380	23276RK+H3276	—	—	405	15	448	A3276	AN76
	310	490	60	77	380	23276RHAK+H3276	—	—	405	15	427	A3276	AN76
<b>380</b>	210	470	52	66	400	23080RK+H3080	—	—	417	15	195	A3080	ANL80
	210	470	52	66	400	23080RHAK+H3080	—	—	417	15	182	A3080	ANL80
	272	520	62	82	400	23180RK+H3180	—	—	421	15	339	A3180	AN80
	272	520	62	82	400	23180RHAK+H3180	—	—	421	15	321	A3180	AN80
	328	520	62	82	400	23280RK+H3280	—	—	427	15	539	A3280	AN80
	328	520	62	82	400	23280RHAK+H3280	—	—	427	15	512	A3280	AN80

Boundary dimensions (mm)					Brg. bore $d$ (mm)	Designations Bearing + adapter ass'y	Mounting dimensions (mm)				Mass Brg.+adapter ass'y (kg)	(Refer.)	
$d_1$	$B_1$	$d_2$	$B_2$	$B_3$			A min.	K min.	$d_e$ min.	$b$ min.		Adapter sleeve No.	Locknut No.
<b>400</b>	212	490	52	66	420	23084RK+H3084	—	—	437	16	205	A3084	ANL84
	212	490	52	66	420	23084RHAK+H3084	—	—	437	16	191	A3084	ANL84
	304	540	70	90	420	23184RK+H3184	—	—	443	16	441	A3184	AN84
	304	540	70	90	420	23184RHA+H3184	—	—	443	16	417	A3184	AN84
	352	540	70	90	420	23284RK+H3284	—	—	448	16	639	A3284	AN84
	352	540	70	90	420	23284RHAK+H3284	—	—	448	16	607	A3284	AN84
<b>410</b>	228	520	60	77	440	23088RK+H3088	—	—	458	17	252	A3088	ANL88
	228	520	60	77	440	23088RHAK+H3088	—	—	458	17	236	A3088	ANL88
	307	560	70	90	440	23188RK+H3188	—	—	464	17	474	A3188	AN88
	307	560	70	90	440	23188RHAK+H3188	—	—	464	17	449	A3188	AN88
	361	560	70	90	440	23288RK+H3288	—	—	469	17	718	A3288	AN88
	361	560	70	90	440	23288RHAK+H3288	—	—	469	17	685	A3288	AN88
<b>430</b>	234	540	60	77	460	23092RK+H3092	—	—	478	17	283	A3092	ANL92
	234	540	60	77	460	23092RHAK+H3092	—	—	478	17	265	A3092	ANL92
	326	580	75	95	460	23192RK+H3192	—	—	485	17	559	A3192	AN92
	326	580	75	95	460	23192RHAK+H3192	—	—	485	17	529	A3192	AN92
	382	580	75	95	460	23292RK+H3292	—	—	491	17	838	A3292	AN92
	382	580	75	95	460	23292RHAK+H3292	—	—	491	17	797	A3292	AN92
<b>450</b>	237	560	60	77	480	23096RK+H3096	—	—	499	18	295	A3096	ANL96
	237	560	60	77	480	23096RHAK+H3096	—	—	499	18	276	A3096	ANL96
	335	620	75	95	480	23196RK+H3196	—	—	505	18	628	A3196	AN96
	335	620	75	95	480	23196RHAK+H3196	—	—	505	18	595	A3196	AN96
	397	620	75	95	480	23296RK+H3296	—	—	512	18	966	A3296	AN96
	397	620	75	95	480	23296RHAK+H3296	—	—	512	18	920	A3296	AN96
<b>470</b>	247	580	68	85	500	230/500RK+H30/500	—	—	519	18	315	A30/500	ANL100
	356	630	80	100	500	231/500RK+H31/500	—	—	527	18	727	A31/500	AN100
	428	630	80	100	500	232/500RK+H32/500	—	—	534	18	1 167	A32/500	AN100

Withdrawal sleeves for spherical roller bearings

$d_1$  35 ~ (75) mm

$d_1$  (75) ~ (115) mm



$d_1$	Boundary dimensions (mm)			$G_1$	Brg. bore $d$ (mm)	Designations Bearing + withdrawal sleeve	Mass Brg.+withdrawal sleeve (kg)	(Refer.) Applicable locknut No.
	$B_1$	$B_2$	$G^{(1)}$ Screw size					
35	29	32	M45×1.5	6	40	22208RHRK+AH308	0.681	AN09
	29	32	M45×1.5	6	40	21308RHK+AH308	0.860	AN09
	40	43	M45×1.5	7	40	22308RHRK+AH2308	1.19	AN09
40	31	34	M50×1.5	6	45	22209RHRK+AH309	0.699	AN10
	31	34	M50×1.5	6	45	21309RHK+AH309	1.14	AN10
	44	47	M50×1.5	7	45	22309RHRK+AH2309	1.55	AN10
45	35	38	M55×2	7	50	22210RHRK+AHX310	0.771	AN11
	35	38	M55×2	7	50	21310RHK+AHX310	1.49	AN11
	50	53	M55×2	9	50	22310RHRK+AHX2310	2.09	AN11
50	37	40	M60×2	7	55	22211RHRK+AHX311	1.01	AN12
	37	40	M60×2	7	55	21311RHK+AHX311	1.83	AN12
	54	57	M60×2	10	55	22311RHRK+AHX2311	2.60	AN12
55	40	43	M65×2	8	60	22212RHRK+AHX312	1.35	AN13
	40	43	M65×2	8	60	21312RHK+AHX312	2.27	AN13
	58	61	M65×2	11	60	22312RHRK+AHX2312	3.29	AN13
60	42	45	M75×2	8	65	22213RHRK+AH313	1.77	AN15
	42	45	M75×2	8	65	21313RHK+AH313	2.84	AN15
	61	64	M75×2	12	65	22313RHRK+AH2313	3.98	AN15
65	43	47	M80×2	8	70	22214RHRK+AH314	1.89	AN16
	43	47	M80×2	8	70	21314RHK+AH314	3.43	AN16
	64	68	M80×2	12	70	22314RHRK+AHX2314	4.82	AN16
70	45	49	M85×2	8	75	22215RHRK+AH315	2.01	AN17
	45	49	M85×2	8	75	21315RHK+AH315	4.07	AN17
	68	72	M85×2	12	75	22315RHRK+AHX2315	5.87	AN17
75	48	52	M90×2	8	80	22216RHRK+AH316	2.49	AN18
	48	52	M90×2	8	80	21316RHK+AH316	4.83	AN18

$d_1$	Boundary dimensions (mm)			$G_1$	Brg. bore $d$ (mm)	Designations Bearing + withdrawal sleeve	Mass Brg.+withdrawal sleeve (kg)	(Refer.) Applicable locknut No.
	$B_1$	$B_2$	$G^{(1)}$ Screw size					
75	71	75	M90×2	12	80	22316RHRK+AHX2316	6.90	AN18
80	52	56	M95×2	9	85	22217RHRK+AHX317	3.12	AN19
	52	56	M95×2	9	85	21317RHK+AHX317	5.68	AN19
	74	78	M95×2	13	85	22317RHRK+AHX2317	7.98	AN19
85	53	57	M100×2	9	90	22218RHRK+AHX318	3.89	AN20
	63	67	M100×2	10	90	23218RHK+AHX3218	5.08	AN20
	53	57	M100×2	9	90	21318RHK+AHX318	6.58	AN20
	79	83	M100×2	14	90	22318RHRK+AHX2318	9.41	AN20
90	57	61	M105×2	10	95	22219RHRK+AHX319	4.68	AN21
	57	61	M105×2	10	95	21319RHK+AHX319	7.59	AN21
	85	89	M105×2	16	95	22319RHRK+AHX2319	10.9	AN21
95	59	63	M110×2	10	100	22220RHRK+AHX320	5.58	AN22
	73	77	M110×2	11	100	23220RHK+AHX3220	7.43	AN22
	59	63	M110×2	10	100	21320RHK+AHX320	9.26	AN22
	90	94	M110×2	16	100	22320RHRK+AHX2320	13.9	AN22
105	68	72	M120×2	11	110	23122RHK+AHX3122	6.30	AN24
	82	91	M115×2	13	110	24122RHK30+AH24122	7.60	AN23
	68	72	M120×2	11	110	22222RHRK+AHX3122	7.97	AN24
	82	86	M125×2	11	110	23222RHK+AHX3222	10.5	AN25
	63	67	M120×2	12	110	21322RHK+AHX322	12.3	AN24
115	98	102	M125×2	16	110	22322RHRK+AHX2322	19.1	AN25
	60	64	M130×2	13	120	23024RHK+AHX3024	4.82	AN26
	73	82	M125×2	13	120	24024RHK30+AH24024	5.99	AN25
	75	79	M130×2	12	120	23124RHK+AHX3124	8.69	AN26
	93	102	M130×2	13	120	24124RHK30+AH24124	11.0	AN26
75	79	M130×2	12	120	22224RHRK+AHX3124	10.1	AN26	

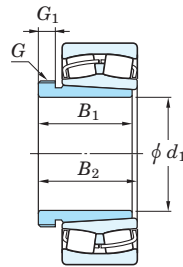
[Note] 1) Basic profile and dimensions of screw thread identified by prefix M are in accordance with JIS B 0205.  
Basic profile and dimensions of screw thread identified by prefix Tr are in accordance with JIS B 0216.



Withdrawal sleeves for spherical roller bearings

$d_1$  (115) ~ (150) mm

$d_1$  (150) ~ 170 mm



$d_1$	Boundary dimensions (mm)			$G_1$	Brg. bore $d$ (mm)	Designations Bearing + withdrawal sleeve	Mass Brg.+withdrawal sleeve (kg)	(Refer.) Applicable locknut No.
	$B_1$	$B_2$	$G^{1)}$ Screw size					
<b>115</b>	90	94	M135×2	13	120	23224RHK+ <b>AHX3224</b>	13.1	AN27
	105	109	M135×2	17	120	22324RHRK+ <b>AHX2324</b>	23.9	AN27
<b>125</b>	67	71	M140×2	14	130	23026RHK+ <b>AHX3026</b>	6.90	AN28
	83	93	M135×2	14	130	24026RHK30+ <b>AH24026</b>	8.74	AN27
	78	82	M140×2	12	130	23126RHK+ <b>AHX3126</b>	9.52	AN28
	94	104	M140×2	14	130	24126RHK30+ <b>AH24126</b>	11.7	AN28
	78	82	M140×2	12	130	22226RHRK+ <b>AHX3126</b>	12.4	AN28
	98	102	M145×2	15	130	23226RHK+ <b>AHX3226</b>	15.6	AN29
	115	119	M145×2	19	130	22326RHRK+ <b>AHX2326</b>	29.9	AN29
<b>135</b>	68	73	M150×2	14	140	23028RHK+ <b>AHX3028</b>	7.43	AN30
	83	93	M145×2	14	140	24028RHK30+ <b>AH24028</b>	9.26	AN29
	83	88	M150×2	14	140	23128RHK+ <b>AHX3128</b>	11.5	AN30
	99	109	M150×2	14	140	24128RHK30+ <b>AH24128</b>	14.1	AN30
	83	88	M150×2	14	140	22228RHRK+ <b>AHX3128</b>	15.4	AN30
	104	109	M155×3	15	140	23228RHK+ <b>AHX3228</b>	20.3	AN31
	125	130	M155×3	20	140	22328RHK+ <b>AHX2328</b>	35.0	AN31
<b>145</b>	72	77	M160×3	15	150	23030RHK+ <b>AHX3030</b>	8.92	AN32
	90	101	M155×3	15	150	24030RHK30+ <b>AH24030</b>	11.4	AN31
	96	101	M165×3	15	150	23130RHK+ <b>AHX3130</b>	17.7	AN33
	115	126	M160×3	15	150	24130RHK30+ <b>AH24130</b>	21.2	AN32
	96	101	M165×3	15	150	22230RHRK+ <b>AHX3130</b>	20.3	AN33
	114	119	M165×3	17	150	23230RHK+ <b>AHX3230</b>	26.0	AN33
	135	140	M165×3	24	150	22330RK+ <b>AHX2330</b>	45.5	AN33
<b>150</b>	77	82	M170×3	16	160	23032RHK+ <b>AHX3032</b>	11.5	AN34
	95	106	M170×3	15	160	24032RHK30+ <b>AH24032</b>	15.0	AN34
	103	108	M180×3	16	160	23132RHK+ <b>AHX3132</b>	23.4	AN36

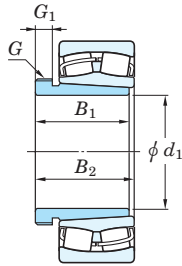
$d_1$	Boundary dimensions (mm)			$G_1$	Brg. bore $d$ (mm)	Designations Bearing + withdrawal sleeve	Mass Brg.+withdrawal sleeve (kg)	(Refer.) Applicable locknut No.
	$B_1$	$B_2$	$G^{1)}$ Screw size					
<b>150</b>	103	108	M180×3	16	160	22232RK+ <b>AH3132</b>	26.1	AN36
	103	108	M180×3	16	160	22232RHAK+ <b>AH3132</b>	24.6	AN36
	124	130	M180×3	20	160	23232RK+ <b>AH3232</b>	35.1	AN36
	124	130	M180×3	20	160	23232RHAK+ <b>AH3232</b>	32.6	AN36
	140	146	M180×3	24	160	22332RK+ <b>AH2332</b>	55.7	AN36
	140	146	M180×3	24	160	22332RHAK+ <b>AH2332</b>	51.8	AN36
<b>160</b>	85	90	M180×3	17	170	23034RHK+ <b>AH3034</b>	15.2	AN36
	106	117	M180×3	16	170	24034RHK30+ <b>AH24034</b>	20.0	AN36
	104	109	M190×3	16	170	23134RHK+ <b>AH3134</b>	24.6	AN38
	125	136	M180×3	16	170	24134RRK30+ <b>AH24134</b>	30.0	AN36
	104	109	M190×3	16	170	22234RK+ <b>AH3134</b>	31.8	AN38
	104	109	M190×3	16	170	22234RHAK+ <b>AH3134</b>	29.9	AN38
	134	140	M190×3	24	170	23234RRK+ <b>AH3234</b>	42.3	AN38
	134	140	M190×3	24	170	23234RHAK+ <b>AH3234</b>	39.4	AN38
<b>170</b>	146	152	M190×3	24	170	22334RK+ <b>AH2334</b>	66.1	AN38
	146	152	M190×3	24	170	22334RHAK+ <b>AH2334</b>	61.4	AN38
	92	98	M190×3	17	180	23036RHK+ <b>AH3036</b>	19.7	AN38
	116	127	M190×3	16	180	24036RRK30+ <b>AH24036</b>	26.1	AN38
	116	122	M200×3	19	180	23136RK+ <b>AH3136</b>	31.7	AN40
	116	122	M200×3	19	180	23136RHAK+ <b>AH3136</b>	29.8	AN40
	134	145	M190×3	16	180	24136RRK30+ <b>AH24136</b>	37.6	AN38
	134	145	M190×3	16	180	24136RHAK30+ <b>AH24136</b>	34.9	AN38
<b>170</b>	105	110	M200×3	17	180	22236RK+ <b>AH2236</b>	33.5	AN40
	105	110	M200×3	17	180	22236RHAK+ <b>AH2236</b>	31.5	AN40
	140	146	M200×3	24	180	23236RRK+ <b>AH3236</b>	45.1	AN40
	140	146	M200×3	24	180	23236RHAK+ <b>AH3236</b>	41.8	AN40
	154	160	M200×3	24	180	22336RK+ <b>AH2336</b>	75.7	AN40
	154	160	M200×3	24	180	22336RHAK+ <b>AH2336</b>	70.3	AN40

[Note] 1) Basic profile and dimensions of screw thread identified by prefix M are in accordance with JIS B 0205.  
Basic profile and dimensions of screw thread identified by prefix Tr are in accordance with JIS B 0216.

Withdrawal sleeves for spherical roller bearings

$d_1$  180 ~ 190 mm

$d_1$  200 ~ 220 mm



$d_1$	Boundary dimensions (mm)			$G_1$	Brg. bore $d$ (mm)	Designations Bearing + withdrawal sleeve	Mass Brg.+withdrawal sleeve (kg)	(Refer.) Applicable locknut No.
	$B_1$	$B_2$	$G^{1)}$ Screw size					
<b>180</b>	96	102	Tr205×4	18	190	23038RK+AH3038	21.5	HNL41
	96	102	Tr205×4	18	190	23038RHAK+AH3038	19.9	HNL41
	118	131	M200×3	18	190	24038RRK30+AH24038	27.6	AN40
	118	131	M200×3	18	190	24038RHAK30+AH24038	25.5	AN40
	125	131	Tr210×4	20	190	23138RK+AH3138	39.3	HN42
	125	131	Tr210×4	20	190	23138RHAK+AH3138	37.0	HN42
	146	159	M200×3	18	190	24138RRK30+AH24138	46.7	AN40
	146	159	M200×3	18	190	24138RHAK30+AH24138	43.8	AN40
	112	117	Tr210×4	18	190	22238RK+AH2238	40.9	HN42
	112	117	Tr210×4	18	190	22238RHAK+AH2238	38.4	HN42
	145	152	Tr210×4	25	190	23238RRK+AH3238	53.3	HN42
	145	152	Tr210×4	25	190	23238RHAK+AH3238	49.4	HN42
	160	167	Tr210×4	26	190	22338RK+AH2338	89.0	HN42
	160	167	Tr210×4	26	190	22338RHAK+AH2338	82.6	HN42
	<b>190</b>	102	108	Tr215×4	19	200	23040RK+AH3040	27.2
102		108	Tr215×4	19	200	23040RHAK+AH3040	25.1	HNL43
127		140	Tr210×4	18	200	24040RRK30+AH24040	34.6	HN42
127		140	Tr210×4	18	200	24040RHAK30+AH24040	31.9	HN42
134		140	Tr220×4	21	200	23140RRK+AH3140	47.9	HN44
134		140	Tr220×4	21	200	23140RHAK+AH3140	45.0	HN44
158		171	Tr210×4	18	200	24140RRK30+AH24140	57.6	HN42
158		171	Tr210×4	18	200	24140RHAK30+AH24140	53.8	HN42
118		123	Tr220×4	19	200	22240RRK+AH2240	48.7	HN44
118		123	Tr220×4	19	200	22240RHAK+AH2240	45.7	HN44
153		160	Tr220×4	25	200	23240RK+AH3240	64.7	HN44
153		160	Tr220×4	25	200	23240RHAK+AH3240	60.1	HN44
170		177	Tr220×4	26	200	22340RK+AH2340	101	HN44
170		177	Tr220×4	26	200	22340RHAK+AH2340	93.4	HN44

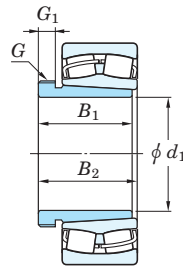
$d_1$	Boundary dimensions (mm)			$G_1$	Brg. bore $d$ (mm)	Designations Bearing + withdrawal sleeve	Mass Brg.+withdrawal sleeve (kg)	(Refer.) Applicable locknut No.	
	$B_1$	$B_2$	$G^{1)}$ Screw size						
<b>200</b>	111	117	Tr235×4	20	220	23044RK+AH3044	38.0	HNL47	
	111	117	Tr235×4	20	220	23044RHAK+AH3044	35.3	HNL47	
	138	152	Tr230×4	20	220	24044RRK30+AH24044	48.1	—	
	138	152	Tr230×4	20	220	24044RHAK30+AH24044	44.7	—	
	145	151	Tr240×4	23	220	23144RK+AH3144	63.6	HN48	
	145	151	Tr240×4	23	220	23144RHAK+AH3144	60.0	HN48	
	170	184	Tr230×4	20	220	24144RRK30+AH24144	76.4	—	
	170	184	Tr230×4	20	220	24144RHAK30+AH24144	71.2	—	
	130	136	Tr240×4	20	220	22244RRK+AH2244	70.8	HN48	
	130	136	Tr240×4	20	220	22244RHAK+AH2244	66.6	HN48	
	181	189	Tr240×4	30	220	23244RK+AH2344	95.1	HN48	
	181	189	Tr240×4	30	220	23244RHAK+AH2344	88.5	HN48	
<b>220</b>	181	189	Tr240×4	30	220	22344RK+AH2344	136	HN48	
	181	189	Tr240×4	30	220	22344RHAK+AH2344	127	HN48	
	<b>220</b>	116	123	Tr260×4	21	240	23048RRK+AH3048	42.6	HNL52
		116	123	Tr260×4	21	240	23048RHAK+AH3048	39.7	HNL52
		138	153	Tr250×4	20	240	24048RRK30+AH24048	51.9	—
		138	153	Tr250×4	20	240	24048RHAK30+AH24048	48.0	—
		154	161	Tr260×4	25	240	23148RRK+AH3148	77.6	HN52
		154	161	Tr260×4	25	240	23148RHAK+AH3148	73.1	HN52
		180	195	Tr260×4	20	240	24148RRK30+AH24148	94.0	HN52
		180	195	Tr260×4	20	240	24148RHAK30+AH24148	87.9	HN52
		144	150	Tr260×4	21	240	22248RK+AH2248	94.3	HN52
		144	150	Tr260×4	21	240	22248RHAK+AH2248	88.7	HN52
189		197	Tr260×4	30	240	23248RRK+AH2348	126	HN52	
189		197	Tr260×4	30	240	23248RHAK+AH2348	117	HN52	
<b>220</b>	189	197	Tr260×4	30	240	22348RK+AH2348	170	HN52	
	189	197	Tr260×4	30	240	22348RHAK+AH2348	158	HN52	

[Note] 1) Basic profile and dimensions of screw thread identified by prefix M are in accordance with JIS B 0205.  
Basic profile and dimensions of screw thread identified by prefix Tr are in accordance with JIS B 0216.

Withdrawal sleeves for spherical roller bearings

$d_1$  240 ~ 260 mm

$d_1$  280 ~ (320) mm



$d_1$	Boundary dimensions (mm)			$G_1$	Brg. bore $d$ (mm)	Designations Bearing + withdrawal sleeve	Mass Brg.+withdrawal sleeve (kg)	(Refer.) Applicable locknut No.
	$B_1$	$B_2$	$G^{1)}$ Screw size					
240	128	135	Tr280×4	23	260	23052RK+AH3052	60.0	HNL56
	128	135	Tr280×4	23	260	23052RHAK+AH3052	55.6	HNL56
	162	178	Tr270×4	22	260	24052RRK30+AH24052	77.0	—
	162	178	Tr270×4	22	260	24052RHAK30+AH24052	71.2	—
	172	179	Tr290×4	26	260	23152RK+AH3152	107	HN58
	172	179	Tr290×4	26	260	23152RHAK+AH3152	101	HN58
	202	218	Tr280×4	22	260	24152RRK30+AH24152	128	—
	202	218	Tr280×4	22	260	24152RHAK30+AH24152	120	—
	155	161	Tr290×4	23	260	22252RK+AH2252	122	HN58
	155	161	Tr290×4	23	260	22252RHAK+AH2252	115	HN58
	205	213	Tr290×4	30	260	23252RK+AH2352	164	HN58
	205	213	Tr290×4	30	260	23252RHAK+AH2352	153	HN58
	205	213	Tr290×4	30	260	22352RK+AH2352	212	HN58
	205	213	Tr290×4	30	260	22352RHAK+AH2352	197	HN58
260	131	139	Tr300×4	24	280	23056RK+AH3056	64.9	HNL60
	131	139	Tr300×4	24	280	23056RHAK+AH3056	60.2	HNL60
	162	179	Tr290×4	22	280	24056RRK30+AH24056	81.9	HN58
	162	179	Tr290×4	22	280	24056RHAK30+AH24056	75.7	HN58
	175	183	Tr310×5	28	280	23156RRK+AH3156	114	HN62
	175	183	Tr310×5	28	280	23156RHAK+AH3156	108	HN62
	202	219	Tr300×4	22	280	24156RRK30+AH24156	136	—
	202	219	Tr300×4	22	280	24156RHAK30+AH24156	128	—
	155	163	Tr310×5	24	280	22256RK+AH2256	127	HN62
	155	163	Tr310×5	24	280	22256RHAK+AH2256	119	HN62
	212	220	Tr310×5	30	280	23256RK+AH2356	175	HN62
	212	220	Tr310×5	30	280	23256RHAK+AH2356	163	HN62
	212	220	Tr310×5	30	280	22356RK+AH2356	247	HN62
	212	220	Tr310×5	30	280	22356RHAK+AH2356	230	HN62

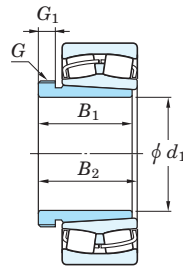
[Note] 1) Basic profile and dimensions of screw thread identified by prefix M are in accordance with JIS B 0205.  
Basic profile and dimensions of screw thread identified by prefix Tr are in accordance with JIS B 0216.

$d_1$	Boundary dimensions (mm)			$G_1$	Brg. bore $d$ (mm)	Designations Bearing + withdrawal sleeve	Mass Brg.+withdrawal sleeve (kg)	(Refer.) Applicable locknut No.	
	$B_1$	$B_2$	$G^{1)}$ Screw size						
280	145	153	Tr320×5	26	300	23060RK+AH3060	88.1	HNL64	
	145	153	Tr320×5	26	300	23060RHAK+AH3060	81.2	HNL64	
	184	202	Tr310×5	24	300	24060RRK30+AH24060	112	HN62	
	184	202	Tr310×5	24	300	24060RHAK30+AH24060	105	HN62	
	192	200	Tr330×5	30	300	23160RRK+AH3160	149	HN66	
	192	200	Tr330×5	30	300	23160RHAK+AH3160	140	HN66	
	224	242	Tr320×5	24	300	24160RRK30+AH24160	180	—	
	224	242	Tr320×5	24	300	24160RHAK30+AH24160	168	—	
	170	178	Tr330×5	26	300	22260RK+AH2260	160	HN66	
	170	178	Tr330×5	26	300	22260RHAK+AH2260	150	HN66	
	228	236	Tr330×5	34	300	23260RK+AH3260	223	HN66	
	228	236	Tr330×5	34	300	23260RHAK+AH3260	208	HN66	
	300	149	157	Tr345×5	27	320	23064RK+AH3064	94.8	HNL69
		149	157	Tr345×5	27	320	23064RHAK+AH3064	88.1	HNL69
184		202	Tr330×5	24	320	24064RRK30+AH24064	120	HN66	
184		202	Tr330×5	24	320	24064RHAK30+AH24064	108	HN66	
209		217	Tr350×5	31	320	23164RK+AH3164	191	HN70	
209		217	Tr350×5	31	320	23164RHAK+AH3164	180	HN70	
242		260	Tr340×5	24	320	24164RRK30+AH24164	226	—	
242		260	Tr340×5	24	320	24164RHAK30+AH24164	217	—	
180		190	Tr350×5	27	320	22264RK+AH2264	191	HN70	
246		254	Tr350×5	36	320	23264RK+AH3264	280	HN70	
246	254	Tr350×5	36	320	23264RHAK+AH3264	260	HN70		
320	162	171	Tr365×5	28	340	23068RK+AH3068	125	HNL73	
	162	171	Tr365×5	28	340	23068RHAK+AH3068	115	HNL73	
	225	234	Tr370×5	33	340	23168RK+AH3168	239	HN74	
	225	234	Tr370×5	33	340	23168RHAK+AH3168	225	HN74	
	269	288	Tr360×5	26	340	24168RRK30+AH24168	293	—	
	269	288	Tr360×5	26	340	24168RHAK30+AH24168	293	—	

Withdrawal sleeves for spherical roller bearings

$d_1$  (320) ~ 380 mm

$d_1$  400 ~ 480 mm



$d_1$	Boundary dimensions (mm)			$G_1$	Brg. bore $d$ (mm)	Designations Bearing + withdrawal sleeve	Mass Brg.+withdrawal sleeve (kg)	(Refer.) Applicable locknut No.
	$B_1$	$B_2$	$G^{1)}$ Screw size					
320	269	288	Tr360x5	26	340	24168RHAK30+AH24168	282	—
	264	273	Tr370x5	38	340	23268RK+AH3268	342	HN74
	264	273	Tr370x5	38	340	23268RHAK+AH3268	317	HN74
340	167	176	Tr385x5	30	360	23072RK+AH3072	132	HNL77
	167	176	Tr385x5	30	360	23072RHAK+AH3072	122	HNL77
	229	238	Tr400x5	35	360	23172RK+AH3172	254	HN80
	232	238	Tr400x5	35	360	23172RHAK+AH3172	239	HN80
	269	289	Tr380x5	26	360	24172RK30+AH24172	313	—
	269	289	Tr380x5	26	360	24172RHAK30+AH24172	300	—
	274	283	Tr400x5	40	360	23272RK+AH3272	388	HN80
	274	283	Tr400x5	40	360	23272RHAK+AH3272	360	HN80
	360	170	180	Tr410x5	31	380	23076RK+AH3076	141
170		180	Tr410x5	31	380	23076RHAK+AH3076	131	HNL82
232		242	Tr420x5	36	380	23176RK+AH3176	269	HN84
240		242	Tr420x5	36	380	23176RHAK+AH3176	253	HN84
271		291	Tr400x5	28	380	24176RK30+AH24176	328	HN80
271		291	Tr400x5	28	380	24176RHAK30+AH24176	314	HN80
284		294	Tr420x5	42	380	23276RK+AH3276	432	HN84
284		294	Tr420x5	42	380	23276RHAK+AH3276	400	HN84
380		183	193	Tr430x5	33	400	23080RK+AH3080	178
	183	193	Tr430x5	33	400	23080RHAK+AH3080	165	HNL86
	240	250	Tr440x5	38	400	23180RK+AH3180	305	HN88
	266	250	Tr440x5	38	400	23180RHAK+AH3180	287	HN88
	278	298	Tr420x5	28	400	24180RK30+AH24180	368	HN84
	278	298	Tr420x5	28	400	24180RHAK30+AH24180	352	HN84
	302	312	Tr440x5	44	400	23280RK+AH3280	521	HN88
	302	312	Tr440x5	44	400	23280RHAK+AH3280	480	HN88

$d_1$	Boundary dimensions (mm)			$G_1$	Brg. bore $d$ (mm)	Designations Bearing + withdrawal sleeve	Mass Brg.+withdrawal sleeve (kg)	(Refer.) Applicable locknut No.
	$B_1$	$B_2$	$G^{1)}$ Screw size					
400	186	196	Tr450x5	34	420	23084RK+AH3084	188	HNL90
	186	196	Tr450x5	34	420	23084RHAK+AH3084	174	HNL90
	266	276	Tr460x5	40	420	23184RK+AH3184	399	HN92
	270	276	Tr460x5	40	420	23184RHAK+AH3184	375	HN92
	321	331	Tr460x5	46	420	23284RK+AH3284	673	HN92
	321	331	Tr460x5	46	420	23284RHAK+AH3284	568	HN92
420	194	205	Tr470x5	35	440	23088RK+AHX3088	215	HNL94
	194	205	Tr470x5	35	440	23088RHAK+AHX3088	199	HNL94
	270	281	Tr480x5	42	440	23188RK+AHX3188	416	HN96
	285	281	Tr480x5	42	440	23188RHAK+AHX3188	391	HN96
	330	341	Tr480x5	48	440	23288RK+AHX3288	678	HN96
	330	341	Tr480x5	48	440	23288RHAK+AHX3288	627	HN96
440	202	213	Tr490x5	37	460	23092RK+AHX3092	244	HNL98
	202	213	Tr490x5	37	460	23092RHAK+AHX3092	226	HNL98
	285	296	Tr510x6	43	460	23192RK+AHX3192	494	HN102
	295	296	Tr510x6	43	460	23192RHAK+AHX3192	464	HN102
	349	360	Tr510x6	50	460	23292RK+AHX3292	795	HN102
	349	360	Tr510x6	50	460	23292RHAK+AHX3292	733	HN102
460	205	217	Tr520x6	38	480	23096RK+AHX3096	257	HNL104
	205	217	Tr520x6	38	480	23096RHAK+AHX3096	238	HNL104
	295	307	Tr530x6	45	480	23196RK+AHX3196	551	HN106
	313	307	Tr530x6	45	480	23196RHAK+AHX3196	518	HN106
	364	376	Tr530x6	52	480	23296RK+AHX3296	914	HN106
	364	376	Tr530x6	52	480	23296RHAK+AHX3296	844	HN106
480	209	221	Tr540x6	40	500	230/500RK+AHX30/500	271	HNL108
	313	325	Tr550x6	47	500	231/500RK+AHX31/500	648	HN110
	393	405	Tr550x6	54	500	232/500RK+AHX32/500	1 015	HN110

[Note] 1) Basic profile and dimensions of screw thread identified by prefix M are in accordance with JIS B 0205.  
Basic profile and dimensions of screw thread identified by prefix Tr are in accordance with JIS B 0216.

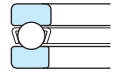
## Thrust ball bearings

Thrust ball bearings are divided into single and double direction types. The former is able to accommodate axial load in one direction, while the latter is able to accommodate it in both directions.

Neither is suitable for applications that involve radial load or high-speed rotation.

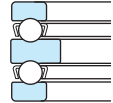
Bearings whose housing race back face is spherical (with a spherical back face or aligning seat race) are designed with a self-aligning capability and can accommodate the effects of inaccurate mounting.

### Single direction thrust ball bearings



Bore diameter 10 – 360 mm

### Double direction thrust ball bearings



Bore diameter 10 – 190 mm



Boundary dimensions	As specified in JIS B 1512.
Tolerances	As specified in JIS B 1514-2. (refer to Table 7-9 on p. A 74.)
Recommended fits	Refer to Table 9-8 on p. A 98.
Standard cages	<ul style="list-style-type: none"> <li>• Pressed steel cage (supplementary code : //)</li> <li>• Copper alloy or carbon steel machined cage (supplementary code : FY or FC)</li> <li>• Polyamide resin molded cage (supplementary code : MG)</li> </ul>

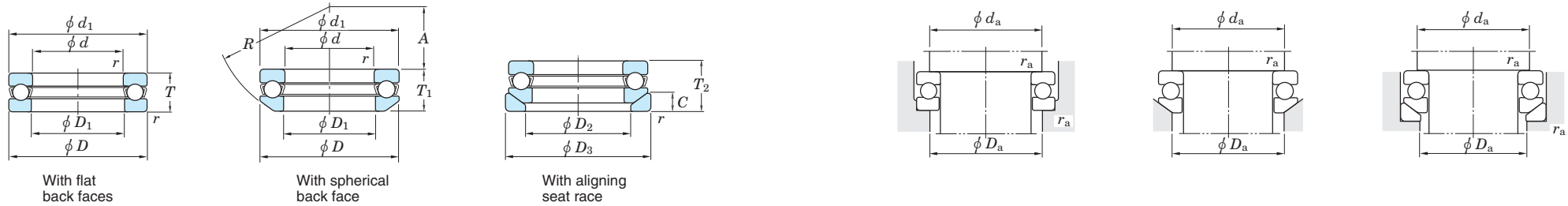
### Application of standard cages

Bearing series	Molded cage	Pressed cage	Machined cage
511	51100 – 51107	51108 – 51132	51134 – 51172
512	51200 – 51207	51208 – 51224	51226 – 51272
532	53200 – 53207	53208 – 53224	53226 – 53272
532 U	53200U – 53207U	53208U – 53224U	53226U – 53272U
513	–	51305 – 51313	51314 – 51340
533	–	53305 – 53313	53314 – 53340
533 U	–	53305U – 53313U	53314U – 53340U
514	–	51405 – 51416	51417 – 51436
534	–	53405 – 53416	53417 – 53420
534 U	–	53405U – 53416U	53417U – 53420U
522	–	52202 – 52224	52226 – 52244
542	–	54202 – 54224	54226 – 54244
542 U	–	54205U – 54224U	54226U – 54244U
523	–	52305 – 52313	52314 – 52340
543	–	54305 – 54313	54314 – 54324
543 U	–	54305U – 54313U	54314U – 54324U
524	–	52405 – 52411	52412 – 52444
544	–	54405 – 54411	54412 – 54420
544 U	–	54405U – 54411U	54412U – 54420U

Required minimum axial load	A certain degree of load is necessary in order for bearings to operate satisfactorily. (refer to p. A 116.)
Allowable misalignment	Misalignment not allowed. (for flat back face type.)
Equivalent axial load	Dynamic equivalent axial load $P_a = F_a$ Static equivalent axial load $P_{0a} = F_a$

Single direction thrust ball bearings

$d$  10 ~ (40) mm

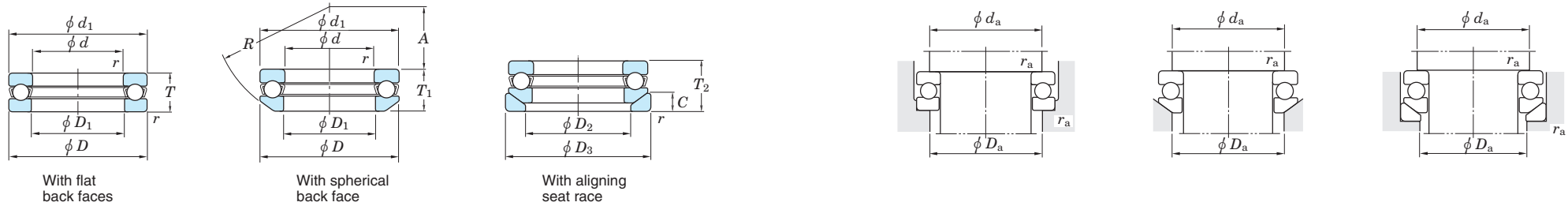


Boundary dimensions (mm)						Basic load ratings (kN)		Fatigue load limit (kN)	Limiting speeds (min <sup>-1</sup> )		Bearing No.			Dimensions (mm)						Mounting dimensions (mm)			(Refer.) Mass (kg)			
$d$	$D$	$T$	$T_1$	$T_2$	$r_{min.}$	$C_a$	$C_{0a}$	$C_u$	Grease lub.	Oil lub.	With flat back faces	With spherical back face	With aligning seat race	$d_1$ max.	$D_1$ min.	$D_2$	$D_3$	$A$	$R$	$C$	$d_a$ min.	$D_a$ max.	$r_a$ max.	With flat back faces	With spherical back face	With aligning seat race
10	24	9	—	—	0.3	12.5	14.0	0.630	6 500	10 000	51100	—	—	24	11	—	—	—	—	—	18	16	0.3	0.020	—	—
	26	11	11.6	13	0.6	15.8	17.1	0.770	5 700	8 800	51200	53200	53200U	26	12	18	28	8.5	22	3.5	20	16	0.6	0.030	0.029	0.037
12	26	9	—	—	0.3	12.9	14.0	0.690	6 500	10 000	51101	—	—	26	13	—	—	—	—	—	20	18	0.3	0.022	—	—
	28	11	11.4	13	0.6	16.5	19.0	0.860	5 400	8 300	51201	53201	53201U	28	14	20	30	11.5	25	3.5	22	18	0.6	0.034	0.031	0.043
15	28	9	—	—	0.3	13.2	15.4	0.760	6 100	9 400	51102	—	—	28	16	—	—	—	—	—	23	20	0.3	0.024	—	—
	32	12	13.3	15	0.6	20.8	24.8	1.10	4 900	7 500	51202	53202	53202U	32	17	24	35	12	28	4	25	22	0.6	0.046	0.048	0.062
17	30	9	—	—	0.3	13.5	18.2	0.820	6 100	9 400	51103	—	—	30	18	—	—	—	—	—	25	22	0.3	0.028	—	—
	35	12	13.2	15	0.6	21.5	27.3	1.25	4 900	7 500	51203	53203	53203U	35	19	26	38	16	32	4	28	24	0.6	0.053	0.055	0.070
20	35	10	—	—	0.3	17.8	24.7	1.10	5 100	7 900	51104	—	—	35	21	—	—	—	—	—	29	26	0.3	0.040	—	—
	40	14	14.7	17	0.6	27.9	37.7	1.70	3 900	6 000	51204	53204	53204U	40	22	30	42	18	36	5	32	28	0.6	0.082	0.080	0.100
25	42	11	—	—	0.6	24.4	37.2	1.70	4 400	6 800	51105	—	—	42	26	—	—	—	—	—	35	32	0.6	0.059	—	—
	47	15	16.7	19	0.6	34.6	50.4	2.30	3 600	5 500	51205	53205	53205U	47	27	36	50	19	40	5.5	38	34	0.6	0.120	0.120	0.152
	52	18	19.8	22	1	44.7	61.4	2.75	3 100	4 800	51305	53305	53305U	52	27	38	55	21	45	6	41	36	1	0.180	0.180	0.224
	60	24	26.4	29	1	69.5	89.4	4.05	2 600	4 000	51405	53405	53405U	60	27	42	62	19	50	8	46	39	1	0.340	0.350	0.442
30	47	11	—	—	0.6	25.5	42.2	1.90	4 300	6 600	51106	—	—	47	32	—	—	—	—	—	40	37	0.6	0.068	—	—
	52	16	17.8	20	0.6	36.7	58.2	2.65	3 400	5 200	51206	53206	53206U	52	32	42	55	22	45	5.5	43	39	0.6	0.150	0.160	0.193
	60	21	22.6	25	1	53.5	78.7	3.55	2 700	4 200	51306	53306	53306U	60	32	45	62	22	50	7	48	42	1	0.270	0.270	0.326
	70	28	30.1	33	1	91.0	126	5.70	2 200	3 400	51406	53406	53406U	70	32	50	75	20	56	9	54	46	1	0.530	0.530	0.660
35	52	12	—	—	0.6	25.5	47.2	2.00	3 900	6 000	51107	—	—	52	37	—	—	—	—	—	45	42	0.6	0.090	—	—
	62	18	19.9	22	1	48.9	78.2	3.55	2 900	4 500	51207	53207	53207U	62	37	48	65	24	50	7	51	46	1	0.220	0.220	0.277
	68	24	25.6	28	1	69.3	105	4.75	2 400	3 700	51307	53307	53307U	68	37	52	72	24	56	7.5	55	48	1	0.390	0.400	0.484
	80	32	34	37	1.1	109	155	7.00	1 900	2 900	51407	53407	53407U	80	37	58	85	23	64	10	62	53	1	0.790	0.790	0.960
40	60	13	—	—	0.6	33.6	62.8	2.85	3 400	5 300	51108	—	—	60	42	—	—	—	—	—	52	48	0.6	0.120	—	—
	68	19	20.3	23	1	58.7	98.3	4.45	2 700	4 200	51208	53208	53208U	68	42	55	72	28.5	56	7	57	51	1	0.270	0.270	0.340
	78	26	28.5	31	1	86.6	135	6.05	2 100	3 300	51308	53308	53308U	78	42	60	82	28	64	8.5	63	55	1	0.550	0.570	0.690

[Remark] Standard cage types used for the above bearings are described earlier in this section.

Single direction thrust ball bearings

$d$  (40) ~ 70 mm

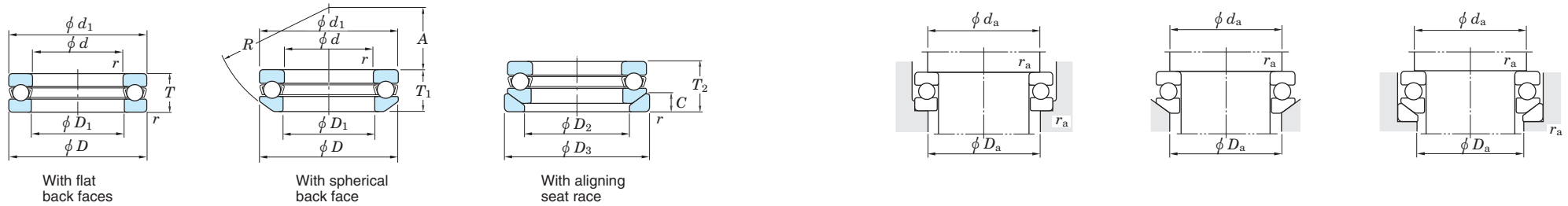


Boundary dimensions (mm)						Basic load ratings (kN)		Fatigue load limit (kN)	Limiting speeds (min <sup>-1</sup> )		Bearing No.			Dimensions (mm)						Mounting dimensions (mm)			(Refer.) Mass (kg)				
$d$	$D$	$T$	$T_1$	$T_2$	$r_{min.}$	$C_a$	$C_{0a}$	$C_u$	Grease lub.	Oil lub.	With flat back faces	With spherical back face	With aligning seat race	$d_1$ max.	$D_1$ min.	$D_2$	$D_3$	$A$	$R$	$C$	$d_a$ min.	$D_a$ max.	$r_a$ max.	With flat back faces	With spherical back face	With aligning seat race	
40	90	36	38.2	42	1.1	141	205	9.25	1 700	2 600	51408	53408	53408U	90	42	65	95	26	72	12	70	60	1	1.14	1.12	1.37	
	45	65	14	—	—	0.6	34.8	69.1	3.10	3 200	5 000	51109	—	—	65	47	—	—	—	—	—	57	53	0.6	0.150	—	—
		73	20	21.3	24	1	59.7	105	4.75	2 600	4 000	51209	53209	53209U	73	47	60	78	26	56	7.5	62	56	1	0.320	0.310	0.397
		85	28	30.1	33	1	100	163	7.40	1 900	3 000	51309	53309	53309U	85	47	65	90	25	64	10	69	61	1	0.690	0.680	0.850
100	39	42.4	46	1.1	162	242	10.9	1 500	2 300	51409	53409	53409U	100	47	72	105	29	80	12.5	78	67	1	1.47	1.50	1.82		
50	70	14	—	—	0.6	35.9	75.4	3.40	3 100	4 800	51110	—	—	70	52	—	—	—	—	—	62	58	0.6	0.160	—	—	
	78	22	23.5	26	1	60.6	111	5.05	2 300	3 600	51210	53210	53210U	78	52	62	82	32.5	64	7.5	67	61	1	0.390	0.380	0.480	
	95	31	34.3	37	1.1	121	202	9.10	1 800	2 700	51310	53310	53310U	95	52	72	100	28	72	11	77	68	1	1.00	1.01	1.24	
	110	43	45.6	50	1.5	185	283	12.8	1 400	2 100	51410	53410	53410U	110	52	80	115	35	90	14	86	74	1.5	1.99	1.97	2.38	
55	78	16	—	—	0.6	43.5	93.1	4.20	2 800	4 300	51111	—	—	78	57	—	—	—	—	—	69	64	0.6	0.240	—	—	
	90	25	27.3	30	1	86.7	159	7.20	2 100	3 200	51211	53211	53211U	90	57	72	95	35	72	9	76	69	1	0.610	0.620	0.770	
	105	35	39.3	42	1.1	149	246	11.1	1 600	2 400	51311	53311	53311U	105	57	80	110	30	80	11.5	85	75	1	1.34	1.41	1.69	
	120	48	50.5	55	1.5	223	359	16.2	1 200	1 900	51411	53411	53411U	120	57	88	125	28	90	15.5	94	81	1.5	2.64	2.57	3.10	
60	85	17	—	—	1	51.8	113	5.10	2 600	4 000	51112	—	—	85	62	—	—	—	—	—	75	70	1	0.290	—	—	
	95	26	28	31	1	92.0	179	8.05	1 900	3 000	51212	53212	53212U	95	62	78	100	32.5	72	9	81	74	1	0.690	0.690	0.850	
	110	35	38.3	42	1.1	154	267	12.1	1 500	2 300	51312	53312	53312U	110	62	85	115	41	90	11.5	90	80	1	1.43	1.47	1.78	
	130	51	54	58	1.5	267	437	19.7	1 100	1 700	51412	53412	53412U	130	62	95	135	34	100	16	102	88	1.5	3.51	3.44	4.13	
65	90	18	—	—	1	52.1	117	5.30	2 400	3 700	51113	—	—	90	67	—	—	—	—	—	80	75	1	0.340	—	—	
	100	27	28.7	32	1	93.6	189	8.50	1 900	2 900	51213	53213	53213U	100	67	82	105	40	80	9	86	79	1	0.770	0.750	0.930	
	115	36	39.4	43	1.1	159	287	13.0	1 400	2 200	51313	53313	53313U	115	67	90	120	38.5	90	12.5	95	85	1	1.57	1.61	1.95	
	140	56	60.2	65	2	290	493	22.0	1 000	1 600	51413	53413	53413U	140	68	100	145	40	112	17.5	110	95	2	4.47	4.47	5.28	
70	95	18	—	—	1	53.8	127	5.70	2 300	3 600	51114	—	—	95	72	—	—	—	—	—	85	80	1	0.360	—	—	
	105	27	28.8	32	1	95.2	199	8.95	1 800	2 800	51214	53214	53214U	105	72	88	110	38	80	9	91	84	1	0.810	0.800	0.990	
	125	40	44.2	48	1.1	167	291	13.1	1 300	2 000	51314	53314	53314U	125	72	98	130	43	100	13	103	92	1	2.06	2.15	2.56	
	150	60	63.6	69	2	312	553	23.8	940	1 450	51414	53414	53414U	150	73	110	155	34	112	19.5	118	102	2	5.48	5.38	6.37	

[Remark] Standard cage types used for the above bearings are described earlier in this section.

Single direction thrust ball bearings

d 75 ~ (120) mm



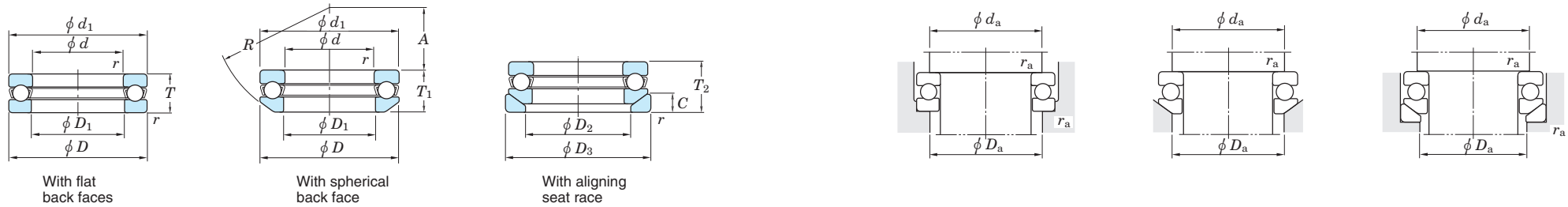
Boundary dimensions (mm)						Basic load ratings (kN)		Fatigue load limit (kN)	Limiting speeds (min <sup>-1</sup> )		Bearing No.			Dimensions (mm)						Mounting dimensions (mm)			(Refer.) Mass (kg)			
d	D	T	T <sub>1</sub>	T <sub>2</sub>	r min.	C <sub>a</sub>	C <sub>0a</sub>	C <sub>u</sub>	Grease lub.	Oil lub.	With flat back faces	With spherical back face	With aligning seat race	d <sub>1</sub> max.	D <sub>1</sub> min.	D <sub>2</sub>	D <sub>3</sub>	A	R	C	d <sub>a</sub> min.	D <sub>a</sub> max.	r <sub>a</sub> max.	With flat back faces	With spherical back face	With aligning seat race
<b>75</b>	100	19	—	—	1	55.5	136	6.15	2 200	3 400	<b>51115</b>	—	—	100	77	—	—	—	—	—	90	85	1	0.420	—	—
	110	27	28.3	32	1	96.7	209	9.40	1 800	2 700	<b>51215</b>	<b>53215</b>	<b>53215U</b>	110	77	92	115	49	90	9.5	96	89	1	0.860	0.850	1.06
	135	44	48.1	52	1.5	192	339	15.0	1 200	1 900	<b>51315</b>	<b>53315</b>	<b>53315U</b>	135	77	105	140	37	100	15	111	99	1.5	2.68	2.72	3.27
	160	65	69	75	2	315	560	23.3	880	1 350	<b>51415</b>	<b>53415</b>	<b>53415U</b>	160	78	115	165	42	125	21	125	110	2	6.75	6.64	7.87
<b>80</b>	105	19	—	—	1	55.8	141	6.35	2 100	3 300	<b>51116</b>	—	—	105	82	—	—	—	—	—	95	90	1	0.430	—	—
	115	28	29.5	33	1	98.1	218	9.85	1 700	2 600	<b>51216</b>	<b>53216</b>	<b>53216U</b>	115	82	98	120	46	90	10	101	94	1	0.950	0.930	1.15
	140	44	47.6	52	1.5	200	368	15.8	1 200	1 800	<b>51316</b>	<b>53316</b>	<b>53316U</b>	140	82	110	145	50	112	15	116	104	1.5	2.82	2.86	3.43
	170	68	72.2	78	2.1	337	621	25.1	810	1 250	<b>51416</b>	<b>53416</b>	<b>53416U</b>	170	83	125	175	36	125	22	133	117	2	7.97	7.84	9.22
<b>85</b>	110	19	—	—	1	57.4	150	6.80	2 100	3 200	<b>51117</b>	—	—	110	87	—	—	—	—	—	100	95	1	0.460	—	—
	125	31	33.1	37	1	119	264	11.6	1 500	2 300	<b>51217</b>	<b>53217</b>	<b>53217U</b>	125	88	105	130	52	100	11	109	101	1	1.29	1.28	1.57
	150	49	53.1	58	1.5	232	419	17.5	1 100	1 700	<b>51317</b>	<b>53317</b>	<b>53317U</b>	150	88	115	155	43	112	17.5	124	111	1.5	3.66	3.63	4.44
	180	72	77	83	2.1	384	753	29.5	780	1 200	<b>51417</b>	<b>53417</b>	<b>53417U</b>	177	88	130	185	47	140	23	141	124	2	9.29	9.20	10.8
<b>90</b>	120	22	—	—	1	74.6	190	8.40	1 900	2 900	<b>51118</b>	—	—	120	92	—	—	—	—	—	108	102	1	0.680	—	—
	135	35	38.5	42	1.1	146	326	13.9	1 400	2 100	<b>51218</b>	<b>53218</b>	<b>53218U</b>	135	93	110	140	45	100	13.5	117	108	1	1.77	1.77	2.19
	155	50	54.6	59	1.5	242	454	18.5	1 000	1 600	<b>51318</b>	<b>53318</b>	<b>53318U</b>	155	93	120	160	40	112	18	129	116	1.5	3.88	3.87	4.71
	190	77	81.2	88	2.1	409	826	31.5	710	1 100	<b>51418</b>	<b>53418</b>	<b>53418U</b>	187	93	140	195	40	140	25.5	149	131	2	11.0	10.7	12.6
<b>100</b>	135	25	—	—	1	106	268	11.2	1 600	2 500	<b>51120</b>	—	—	135	102	—	—	—	—	—	121	114	1	0.990	—	—
	150	38	40.9	45	1.1	183	410	16.6	1 200	1 900	<b>51220</b>	<b>53220</b>	<b>53220U</b>	150	103	125	155	52	112	14	130	120	1	2.36	2.34	2.84
	170	55	59.2	64	1.5	296	595	23.2	940	1 450	<b>51320</b>	<b>53320</b>	<b>53320U</b>	170	103	135	175	46	125	18	142	128	1.5	5.11	5.10	6.05
	210	85	90	98	3	460	983	35.7	620	950	<b>51420</b>	<b>53420</b>	<b>53420U</b>	205	103	155	220	50	160	27	165	145	2.5	14.6	14.5	17.4
<b>110</b>	145	25	—	—	1	109	288	11.5	1 600	2 400	<b>51122</b>	—	—	145	112	—	—	—	—	—	131	124	1	1.08	—	—
	160	38	40.2	45	1.1	191	450	17.6	1 200	1 800	<b>51222</b>	<b>53222</b>	<b>53222U</b>	160	113	135	165	65	125	14	140	130	1	2.57	2.50	3.06
	190	63	67.2	72	2	334	704	25.9	810	1 250	<b>51322</b>	<b>53322</b>	<b>53322U</b>	187	113	150	195	51	140	20.5	158	142	2	7.72	7.63	8.90
	230	95	—	—	3	474	1 070	37.1	550	850	<b>51422</b>	—	—	225	113	—	—	—	—	—	181	159	2.5	19.8	—	—
<b>120</b>	155	25	—	—	1	111	305	11.9	1 500	2 300	<b>51124</b>	—	—	155	122	—	—	—	—	—	141	134	1	1.16	—	—

[Remark] Standard cage types used for the above bearings are described earlier in this section.



Single direction thrust ball bearings

$d$  (120) ~ (180) mm

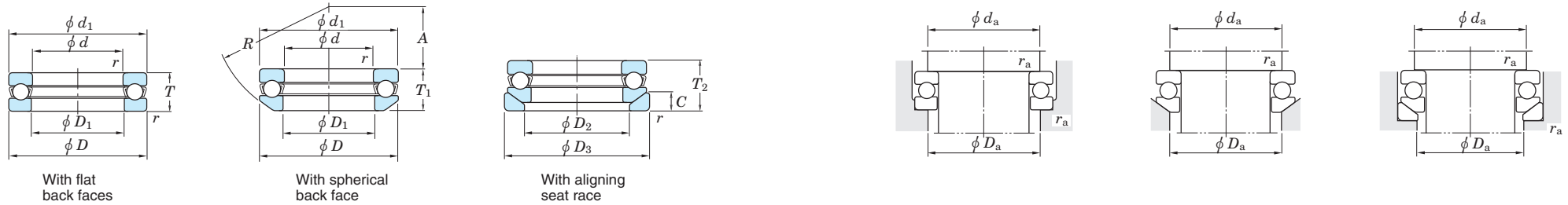


Boundary dimensions (mm)						Basic load ratings (kN)		Fatigue load limit (kN)	Limiting speeds (min <sup>-1</sup> )		Bearing No.			Dimensions (mm)						Mounting dimensions (mm)			(Refer.) Mass (kg)			
$d$	$D$	$T$	$T_1$	$T_2$	$r$ min.	$C_a$	$C_{0a}$	$C_u$	Grease lub.	Oil lub.	With flat back faces	With spherical back face	With aligning seat race	$d_1$ max.	$D_1$ min.	$D_2$	$D_3$	$A$	$R$	$C$	$d_a$ min.	$D_a$ max.	$r_a$ max.	With flat back faces	With spherical back face	With aligning seat race
<b>120</b>	170	39	40.8	46	1.1	192	470	17.7	1 100	1 700	<b>51224</b>	<b>53224</b>	<b>53224U</b>	170	123	145	175	61	125	15	150	140	1	2.86	2.81	3.46
	210	70	74.1	80	2.1	389	869	30.5	710	1 100	<b>51324</b>	<b>53324</b>	<b>53324U</b>	205	123	165	220	63	160	22	173	157	2	10.6	10.4	12.4
	250	102	—	—	4	601	1 460	48.5	520	800	<b>51424</b>	—	—	245	123	—	—	—	—	—	196	174	3	25.0	—	—
<b>130</b>	170	30	—	—	1	130	350	13.0	1 300	2 000	<b>51126</b>	—	—	170	132	—	—	—	—	—	154	146	1	1.87	—	—
	190	45	47.9	53	1.5	254	620	22.2	970	1 500	<b>51226</b>	<b>53226</b>	<b>53226U</b>	187	133	160	195	67	140	17	166	154	1.5	4.09	3.98	4.88
	225	75	80.3	86	2.1	413	958	32.5	650	1 000	<b>51326</b>	<b>53326</b>	<b>53326U</b>	220	134	177	235	53	160	26	186	169	2	13.0	12.7	15.2
	270	110	—	—	4	623	1 540	49.0	490	750	<b>51426</b>	—	—	265	134	—	—	—	—	—	212	188	3	31.4	—	—
<b>140</b>	180	31	—	—	1	133	375	13.5	1 200	1 900	<b>51128</b>	—	—	178	142	—	—	—	—	—	164	156	1	2.02	—	—
	200	46	48.6	55	1.5	234	650	19.6	940	1 450	<b>51228</b>	<b>53228</b>	<b>53228U</b>	197	143	170	210	87	160	17	176	164	1.5	4.46	4.35	5.89
	240	80	84.9	92	2.1	458	1 130	36.9	620	950	<b>51328</b>	<b>53328</b>	<b>53328U</b>	235	144	190	250	68	180	26	199	181	2	15.5	15.1	18.0
	280	112	—	—	4	650	1 680	52.2	450	700	<b>51428</b>	—	—	275	144	—	—	—	—	—	222	198	3	33.9	—	—
<b>150</b>	190	31	—	—	1	137	400	13.9	1 200	1 900	<b>51130</b>	—	—	188	152	—	—	—	—	—	174	166	1	2.15	—	—
	215	50	53.3	60	1.5	266	652	21.8	840	1 300	<b>51230</b>	<b>53230</b>	<b>53230U</b>	212	153	180	225	79	160	20.5	189	176	1.5	5.64	5.45	7.14
	250	80	83.7	92	2.1	451	1 130	36.0	580	900	<b>51330</b>	<b>53330</b>	<b>53330U</b>	245	154	200	260	89.5	200	26	209	191	2	16.3	15.7	18.8
	300	120	—	—	4	711	1 910	57.4	420	650	<b>51430</b>	—	—	295	154	—	—	—	—	—	238	212	3	41.6	—	—
<b>160</b>	200	31	—	—	1	140	425	14.4	1 200	1 800	<b>51132</b>	—	—	198	162	—	—	—	—	—	184	176	1	2.28	—	—
	225	51	54.7	61	1.5	279	718	23.4	810	1 250	<b>51232</b>	<b>53232</b>	<b>53232U</b>	222	163	190	235	74	160	21	199	186	1.5	6.53	6.09	7.90
	270	87	91.7	100	3	512	1 340	41.3	550	850	<b>51332</b>	<b>53332</b>	<b>53332U</b>	265	164	215	280	77	200	29	225	205	2.5	21.0	21.0	23.4
	320	130	—	—	5	852	2 410	70.3	390	600	<b>51432</b>	—	—	315	164	—	—	—	—	—	254	226	4	51.2	—	—
<b>170</b>	215	34	—	—	1.1	168	510	16.7	1 100	1 700	<b>51134</b>	—	—	213	172	—	—	—	—	—	197	188	1	3.25	—	—
	240	55	58.7	65	1.5	326	834	26.3	750	1 150	<b>51234</b>	<b>53234</b>	<b>53234U</b>	237	173	200	250	91	180	21.5	212	198	1.5	8.12	7.69	9.83
	280	87	91.3	100	3	579	1 570	47.4	520	800	<b>51334</b>	<b>53334</b>	<b>53334U</b>	275	174	220	290	105	225	29	235	215	2.5	22.0	22.0	24.5
	340	135	—	—	5	943	2 730	77.2	360	550	<b>51434</b>	—	—	335	174	—	—	—	—	—	270	240	4	60.0	—	—
<b>180</b>	225	34	—	—	1.1	168	525	16.7	1 000	1 600	<b>51136</b>	—	—	222	183	—	—	—	—	—	207	198	1	3.39	—	—
	250	56	58.2	66	1.5	332	874	26.9	710	1 100	<b>51236</b>	<b>53236</b>	<b>53236U</b>	247	183	210	260	112	200	21.5	222	208	1.5	8.68	8.08	10.4
	300	95	99.3	109	3	578	1 580	46.2	490	750	<b>51336</b>	<b>53336</b>	<b>53336U</b>	295	184	240	310	91	225	32	251	229	2.5	28.1	26.9	29.9

[Remark] Standard cage types used for the above bearings are described earlier in this section.

Single direction thrust ball bearings

$d$  (180) ~ 360 mm

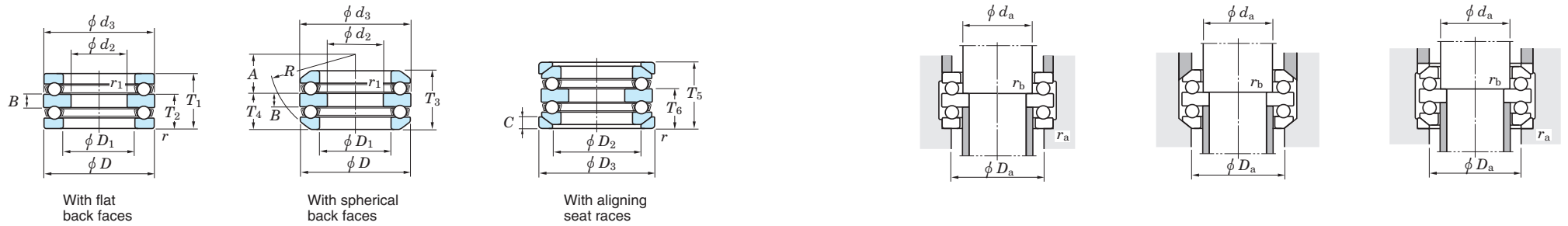


Boundary dimensions (mm)						Basic load ratings (kN)		Fatigue load limit (kN)	Limiting speeds (min <sup>-1</sup> )		Bearing No.			Dimensions (mm)						Mounting dimensions (mm)			(Refer.) Mass (kg)			
$d$	$D$	$T$	$T_1$	$T_2$	$r_{min.}$	$C_a$	$C_{0a}$	$C_u$	Grease lub.	Oil lub.	With flat back faces	With spherical back face	With aligning seat race	$d_1$ max.	$D_1$ min.	$D_2$	$D_3$	$A$	$R$	$C$	$d_a$ min.	$D_a$ max.	$r_a$ max.	With flat back faces	With spherical back face	With aligning seat race
<b>180</b>	360	140	—	—	5	928	2 730	75.1	320	500	<b>51436</b>	—	—	355	184	—	—	—	—	—	286	254	4	69.5	—	—
<b>190</b>	240	37	—	—	1.1	213	655	20.2	970	1 500	<b>51138</b>	—	—	237	193	—	—	—	—	—	220	210	1	3.95	—	—
	270	62	65.7	73	2	385	1 060	31.4	650	1 000	<b>51238</b>	<b>53238</b>	<b>53238U</b>	267	194	230	280	98	200	23	238	222	2	11.7	11.2	13.9
	320	105	111	121	4	679	1 950	55.3	440	680	<b>51338</b>	<b>53338</b>	<b>53338U</b>	315	195	255	330	104	250	33	266	244	3	36.0	36.3	39.7
<b>200</b>	250	37	—	—	1.1	215	675	20.4	940	1 450	<b>51140</b>	—	—	247	203	—	—	—	—	—	230	220	1	4.13	—	—
	280	62	65.3	74	2	392	1 110	32.2	620	950	<b>51240</b>	<b>53240</b>	<b>53240U</b>	277	204	240	290	125	225	23	248	232	2	12.2	11.6	14.8
	340	110	118.4	130	4	745	2 220	61.1	420	650	<b>51340</b>	<b>53340</b>	<b>53340U</b>	335	205	270	350	92	250	38	282	258	3	42.9	42.7	46.7
<b>220</b>	270	37	—	—	1.1	221	740	21.3	880	1 350	<b>51144</b>	—	—	267	223	—	—	—	—	—	250	240	1	4.50	—	—
	300	63	65.6	75	2	428	1 310	36.6	580	900	<b>51244</b>	<b>53244</b>	<b>53244U</b>	297	224	260	310	118	225	25	268	252	2	13.5	12.6	15.9
<b>240</b>	300	45	—	—	1.5	301	1 020	28.0	750	1 150	<b>51148</b>	—	—	297	243	—	—	—	—	—	276	264	1.5	7.38	—	—
	340	78	81.6	92	2.1	553	1 800	47.8	520	800	<b>51248</b>	<b>53248</b>	<b>53248U</b>	335	244	290	350	122	250	30	299	281	2	23.1	20.9	25.6
<b>260</b>	320	45	—	—	1.5	289	990	26.2	710	1 100	<b>51152</b>	—	—	317	263	—	—	—	—	—	296	284	1.5	7.93	—	—
	360	79	82.8	93	2.1	556	1 880	48.1	490	750	<b>51252</b>	<b>53252</b>	<b>53252U</b>	355	264	305	370	152	280	30	319	301	2	25.0	22.6	28.5
<b>280</b>	350	53	—	—	1.5	411	1 430	36.4	640	900	<b>51156</b>	—	—	347	283	—	—	—	—	—	322	308	1.5	12.0	—	—
<b>300</b>	380	62	—	—	2	454	1 610	39.4	540	810	<b>51160</b>	—	—	376	304	—	—	—	—	—	348	332	2	17.5	—	—
	420	95	100.5	112	3	713	2 600	61.9	400	600	<b>51260</b>	<b>53260</b>	<b>53260U</b>	415	304	360	430	164	320	34	371	349	2.5	42.5	39.5	48.0
<b>320</b>	400	63	—	—	2	474	1 760	41.9	540	810	<b>51164</b>	—	—	396	324	—	—	—	—	—	368	352	2	19.0	—	—
	440	95	100.5	112	3	721	2 710	62.9	400	600	<b>51264</b>	<b>53264</b>	<b>53264U</b>	435	325	380	450	157	320	36	391	369	2.5	45.0	42.0	52.0
<b>340</b>	420	64	—	—	2	483	1 860	43.1	500	770	<b>51168</b>	—	—	416	344	—	—	—	—	—	388	372	2	20.5	—	—
	460	96	100.3	113	3	730	2 830	63.8	380	570	<b>51268</b>	<b>53268</b>	<b>53268U</b>	455	345	400	470	199	360	36	411	389	2.5	48.0	45.0	55.0
<b>360</b>	440	65	—	—	2	493	1 960	44.3	500	720	<b>51172</b>	—	—	436	364	—	—	—	—	—	408	392	2	21.5	—	—
	500	110	116.7	130	4	876	3 500	76.1	340	500	<b>51272</b>	<b>53272</b>	<b>53272U</b>	495	365	430	510	172	360	43	443	417	3	70.0	65.0	82.0

[Remark] Standard cage types used for the above bearings are described earlier in this section.

Double direction thrust ball bearings

$d_2$  10 ~ (50) mm

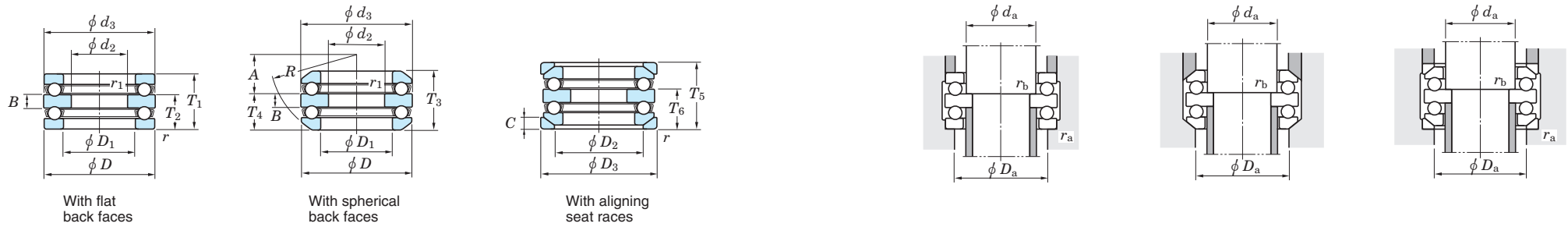


Boundary dimensions (mm)							Basic load ratings (kN)		Fatigue load limit (kN)	Limiting speeds ( $\text{min}^{-1}$ )		Bearing No.			Dimensions (mm)										Mounting dimensions (mm)				(Refer.) Mass (kg)		
$d_2$	$D$	$T_1$	$T_3$	$T_5$	$r_{\text{min}}$	$r_{1 \text{ min}}$	$C_a$	$C_{0a}$	$C_u$	Grease lub.	Oil lub.	With flat back faces	With spherical back faces	With aligning seat races	$d_3$ max.	$D_1$ min.	$D_2$	$D_3$	$T_2$	$T_4$	$T_6$	$A$	$R$	$B$	$C$	$d_a$ min.	$D_a$ max.	$r_a$ max.	$r_b$ max.	With flat back faces	With aligning seat races
10	32	22	24.6	28	0.6	0.3	20.8	24.8	1.10	4 900	7 500	52202	54202	54202U	32	17	24	35	13.5	14.8	16.5	10.5	28	5	4	15	24	0.6	0.3	0.085	0.118
	60	45	49.8	55	1	0.6	69.5	89.4	4.05	2 600	4 000	52405	54405	54405U	60	27	42	62	28	30.4	33	15	50	11	8	25	42	1	0.6	0.630	0.804
20	47	28	31.4	36	0.6	0.3	34.6	50.4	2.30	3 600	5 500	52205	54205	54205U	47	27	36	50	17.5	19.2	21.5	16.5	40	7	5.5	25	36	0.6	0.3	0.230	0.304
	52	34	37.6	42	1	0.3	44.7	61.4	2.75	3 100	4 800	52305	54305	54305U	52	27	38	55	21	22.8	25	18	45	8	6	25	38	1	0.3	0.330	0.428
	70	52	56.2	62	1	0.6	91.0	126	5.70	2 200	3 400	52406	54406	54406U	70	32	50	75	32	34.1	37	16	56	12	9	30	50	1	0.6	1.00	1.25
25	52	29	32.6	37	0.6	0.3	36.7	54.3	2.65	3 400	5 200	52206	54206	54206U	52	32	42	55	18	19.8	22	20	45	7	5.5	30	42	0.6	0.3	0.270	0.346
	60	38	41.2	46	1	0.3	53.5	78.7	3.55	2 700	4 200	52306	54306	54306U	60	32	45	62	23.5	25.1	27.5	19.5	50	9	7	30	45	1	0.3	0.490	0.602
	80	59	63	69	1.1	0.6	109	155	7.00	1 900	2 900	52407	54407	54407U	80	37	58	85	36.5	38.5	41.5	18.5	64	14	10	35	58	1	0.6	1.44	1.79
30	62	34	37.8	42	1	0.3	48.9	83.8	3.55	2 900	4 500	52207	54207	54207U	62	37	48	65	21	22.9	25	21	50	8	7	35	48	1	0.3	0.420	0.544
	68	36	38.6	44	1	0.6	58.7	98.3	4.45	2 700	4 200	52208	54208	54208U	68	42	55	72	22.5	23.8	26.5	25	56	9	7	40	55	1	0.6	0.540	0.680
	68	44	47.2	52	1	0.3	69.3	105	4.75	2 400	3 700	52307	54307	54307U	68	37	52	72	27	28.6	31	21	56	10	7.5	35	52	1	0.3	0.710	0.898
	78	49	54	59	1	0.6	86.6	135	6.05	2 100	3 300	52308	54308	54308U	78	42	60	82	30.5	33	35.5	23.5	64	12	8.5	40	60	1	0.6	1.06	1.34
90	65	69.4	77	1.1	0.6	141	205	9.25	1 700	2 600	52408	54408	54408U	90	42	65	95	40	42.2	46	22	72	15	12	40	65	1	0.6	2.03	2.55	
35	73	37	39.6	45	1	0.6	59.7	105	4.75	2 600	4 000	52209	54209	54209U	73	47	60	78	23	24.3	27	23	56	9	7.5	45	60	1	0.6	0.620	0.784
	85	52	56.2	62	1	0.6	100	163	7.40	1 900	3 000	52309	54309	54309U	85	47	65	90	32	34.1	37	21	64	12	10	45	65	1	0.6	1.29	1.62
	100	72	78.8	86	1.1	0.6	162	242	10.9	1 500	2 300	52409	54409	54409U	100	47	72	105	44.5	47.9	51.5	23.5	80	17	12.5	45	72	1	0.6	2.91	3.42
40	78	39	42	47	1	0.6	60.6	111	5.05	2 300	3 600	52210	54210	54210U	78	52	62	82	24	25.5	28	30.5	64	9	7.5	50	62	1	0.6	0.710	0.890
	95	58	64.6	70	1.1	0.6	121	186	9.10	1 800	2 700	52310	54310	54310U	95	52	72	100	36	39.3	42	23	72	14	11	50	72	1	0.6	1.86	2.35
	110	78	83.2	92	1.5	0.6	185	283	12.8	1 400	2 100	52410	54410	54410U	110	52	80	115	48	50.6	55	30	90	18	14	50	80	1.5	0.6	3.56	4.39
45	90	45	49.6	55	1	0.6	86.7	159	7.20	2 100	3 200	52211	54211	54211U	90	57	72	95	27.5	29.8	32.5	32.5	72	10	9	55	72	1	0.6	1.12	1.44
	105	64	72.6	78	1.1	0.6	149	246	11.1	1 600	2 400	52311	54311	54311U	105	57	80	110	39.5	43.8	46.5	25.5	80	15	11.5	55	80	1	0.6	2.51	3.21
	120	87	92	101	1.5	0.6	223	359	16.2	1 200	1 900	52411	54411	54411U	120	57	88	125	53.5	56	60.5	22.5	90	20	15.5	55	88	1.5	0.6	4.70	5.62
50	95	46	50	56	1	0.6	92.0	179	8.05	1 900	3 000	52212	54212	54212U	95	62	78	100	28	30	33	30.5	72	10	9	60	78	1	0.6	1.25	1.57
	110	64	70.6	78	1.1	0.6	154	267	12.1	1 500	2 300	52312	54312	54312U	110	62	85	115	39.5	42.8	46.5	36.5	90	15	11.5	60	85	1	0.6	2.68	3.37
	130	93	99	107	1.5	0.6	267	397	19.7	1 100	1 700	52412	54412	54412U	130	62	95	135	57	60	64	28	100	21	16	60	95	1.5	0.6	6.33	7.60

[Remark] Standard cage types used for the above bearings are described earlier in this section.

# Double direction thrust ball bearings

$d_2$  (50) ~ 95 mm

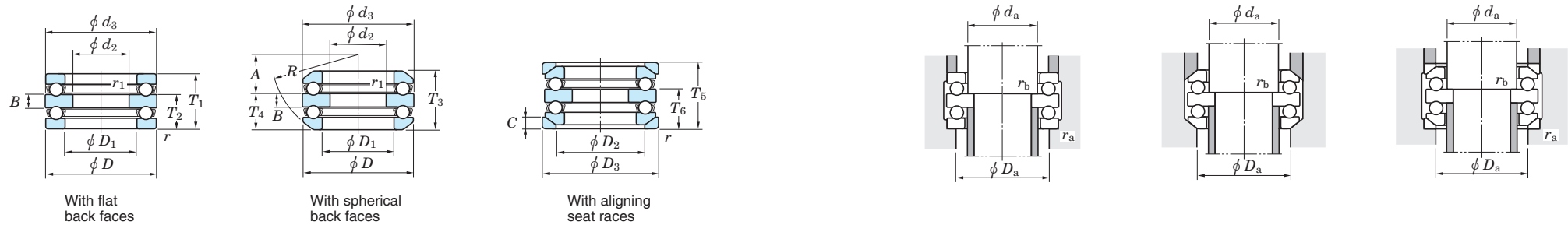


Boundary dimensions (mm)				Basic load ratings (kN)		Fatigue load limit (kN) $C_u$	Limiting speeds ( $\text{min}^{-1}$ )		Bearing No.			Dimensions (mm)									Mounting dimensions (mm)				(Refer.) Mass (kg)						
$d_2$	$D$	$T_1$	$T_3$	$T_5$	$r_{\text{min}}$		$r_{1 \text{ min}}$	$C_a$	$C_{0a}$	Grease lub.	Oil lub.	With flat back faces	With spherical back faces	With aligning seat races	$d_3$ max.	$D_1$ min.	$D_2$	$D_3$	$T_2$	$T_4$	$T_6$	$A$	$R$	$B$	$C$	$d_a$ min.	$D_a$ max.	$r_a$ max.	$r_b$ max.	With flat back faces	With aligning seat races
<b>50</b>	140	101	109.4	119	2	1	290	493	22.0	1 000	1 600	<b>52413</b>	<b>54413</b>	<b>54413U</b>	140	68	100	145	62	66.2	71	34	112	23	17.5	65	100	2	1	8.03	9.72
<b>55</b>	100	47	50.4	57	1	0.6	93.6	189	8.50	1 900	2 900	<b>52213</b>	<b>54213</b>	<b>54213U</b>	100	67	82	105	28.5	30.2	33.5	38.5	80	10	9	65	82	1	0.6	1.36	1.70
	105	47	50.6	57	1	1	95.2	189	8.95	1 800	2 800	<b>52214</b>	<b>54214</b>	<b>54214U</b>	105	72	88	110	28.5	30.3	33.5	36.5	80	10	9	70	88	1	1	1.48	1.84
	115	65	71.8	79	1.1	0.6	159	287	13.0	1 400	2 200	<b>52313</b>	<b>54313</b>	<b>54313U</b>	115	67	90	120	40	43.4	47	34.5	90	15	12.5	65	90	1	0.6	2.90	3.66
	125	72	80.4	88	1.1	1	167	339	13.1	1 300	2 000	<b>52314</b>	<b>54314</b>	<b>54314U</b>	125	72	98	130	44	48.2	52	39	100	16	13	70	98	1	1	3.90	4.78
	150	107	114.2	125	2	1	312	553	23.8	940	1 450	<b>52414</b>	<b>54414</b>	<b>54414U</b>	150	73	110	155	65.5	69.1	74.5	28.5	112	24	19.5	70	110	2	1	9.71	11.6
<b>60</b>	110	47	49.6	57	1	1	96.7	209	9.40	1 800	2 700	<b>52215</b>	<b>54215</b>	<b>54215U</b>	110	77	92	115	28.5	29.8	33.5	47.5	90	10	9.5	75	92	1	1	1.57	1.96
	135	79	87.2	95	1.5	1	192	396	15.0	1 200	1 900	<b>52315</b>	<b>54315</b>	<b>54315U</b>	135	77	105	140	48.5	52.6	56.5	32.5	100	18	15	75	105	1.5	1	4.83	6.08
	160	115	123	135	2	1	315	560	23.3	880	1 350	<b>52415</b>	<b>54415</b>	<b>54415U</b>	160	78	115	165	70.5	74.5	80.5	36.5	125	26	21	75	115	2	1	11.8	14.3
<b>65</b>	115	48	51	58	1	1	98.1	218	9.85	1 700	2 600	<b>52216</b>	<b>54216</b>	<b>54216U</b>	115	82	98	120	29	30.5	34	45	90	10	10	80	98	1	1	1.69	2.09
	140	79	86.2	95	1.5	1	200	424	15.8	1 200	1 800	<b>52316</b>	<b>54316</b>	<b>54316U</b>	140	82	110	145	48.5	52.1	56.5	45.5	112	18	15	80	110	1.5	1	5.06	6.36
	170	120	128.4	140	2.1	1	337	621	25.1	810	1 250	<b>52416</b>	<b>54416</b>	<b>54416U</b>	170	83	125	175	73.5	77.7	83.5	30.5	125	27	22	80	125	2	1	14.0	16.6
	180	128	138	150	2.1	1.1	384	753	29.5	780	1 200	<b>52417</b>	<b>54417</b>	<b>54417U</b>	179.5	88	130	185	78.5	83.5	89.5	40.5	140	29	23	85	130	2	1	17.5	19.7
<b>70</b>	125	55	59.2	67	1	1	119	251	11.6	1 500	2 300	<b>52217</b>	<b>54217</b>	<b>54217U</b>	125	88	105	130	33.5	35.6	39.5	49.5	100	12	11	85	105	1	1	2.34	2.90
	150	87	95.2	105	1.5	1	232	489	17.5	1 100	1 700	<b>52317</b>	<b>54317</b>	<b>54317U</b>	150	88	115	155	53	57.1	62	39	112	19	17.5	85	115	1.5	1	6.43	8.03
	190	135	143.4	157	2.1	1.1	409	826	31.5	710	1 100	<b>52418</b>	<b>54418</b>	<b>54418U</b>	189.5	93	140	195	82.5	86.7	93.5	34.5	140	30	25.5	90	140	2	1	19.6	22.8
<b>75</b>	135	62	69	76	1.1	1	146	326	13.9	1 400	2 100	<b>52218</b>	<b>54218</b>	<b>54218U</b>	135	93	110	140	38	41.5	45	42	100	14	13.5	90	110	1	1	3.22	4.07
	155	88	97.2	106	1.5	1	242	524	18.5	1 000	1 600	<b>52318</b>	<b>54318</b>	<b>54318U</b>	155	93	120	160	53.5	58.1	62.5	36.5	112	19	18	90	120	1.5	1	6.60	8.44
<b>80</b>	210	150	160	176	3	1.1	460	983	35.7	620	950	<b>52420</b>	<b>54420</b>	<b>54420U</b>	209.5	103	155	220	91.5	96.5	104.5	43.5	160	33	27	100	155	2.5	1	26.6	32.0
<b>85</b>	150	67	72.8	81	1.1	1	183	410	16.6	1 200	1 900	<b>52220</b>	<b>54220</b>	<b>54220U</b>	150	103	125	155	41	43.9	48	49	112	15	14	100	125	1	1	4.29	5.25
	170	97	105.4	115	1.5	1	296	596	23.2	940	1 450	<b>52320</b>	<b>54320</b>	<b>54320U</b>	170	103	135	175	59	63.2	68	42	125	21	18	100	135	1.5	1	8.90	10.8
<b>90</b>	230	166	—	—	3	1.1	474	1 070	37.1	550	850	<b>52422</b>	—	—	229	113	—	—	101.5	—	—	—	—	37	—	110	170	2.5	1	34.9	—
<b>95</b>	160	67	71.4	81	1.1	1	191	431	17.6	1 200	1 800	<b>52222</b>	<b>54222</b>	<b>54222U</b>	160	113	135	165	41	43.2	48	62	125	15	14	110	135	1	1	4.68	5.66
	190	110	118.4	128	2	1	334	754	25.9	810	1 250	<b>52322</b>	<b>54322</b>	<b>54322U</b>	189.5	113	150	195	67	71.2	76	47	140	24	20.5	110	150	2	1	13.8	16.3
	250	177	—	—	4	1.5	601	1 460	48.5	520	800	<b>52424</b>	—	—	249	123	—	—	108.5	—	—	—	—	40	—	120	185	3	1.5	44.2	—

[Remark] Standard cage types used for the above bearings are described earlier in this section.

# Double direction thrust ball bearings

$d_2$  100 ~ 190 mm

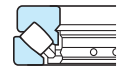


Boundary dimensions (mm)						Basic load ratings (kN)		Fatigue load limit (kN)	Limiting speeds ( $\text{min}^{-1}$ )		Bearing No.			Dimensions (mm)										Mounting dimensions (mm)				(Refer.) Mass (kg)			
$d_2$	$D$	$T_1$	$T_3$	$T_5$	$r_{\text{min}}$	$r_1$	$C_a$	$C_{0a}$	$C_u$	Grease lub.	Oil lub.	With flat back faces	With spherical back faces	With aligning seat races	$d_3$ max.	$D_1$ min.	$D_2$	$D_3$	$T_2$	$T_4$	$T_6$	$A$	$R$	$B$	$C$	$d_a$ min.	$D_a$ max.	$r_a$ max.	$r_b$ max.	With flat back faces	With aligning seat races
100	170	68	71.6	82	1.1	1.1	192	472	17.7	1 100	1 700	52224	54224	54224U	170	123	145	175	41.5	43.3	48.5	58.5	125	15	15	120	145	1	1	5.24	6.44
	210	123	131.2	143	2.1	1.1	389	931	30.5	710	1 100	52324	54324	54324U	209.5	123	165	220	75	79.1	85	58	160	27	22	120	165	2	1	17.2	22.9
	270	192	—	—	4	2	623	1 540	49.0	490	750	52426	—	—	269	134	—	—	117	—	—	—	—	42	—	130	200	3	2	56.5	—
110	190	80	85.8	96	1.5	1.1	254	622	22.2	970	1 500	52226	54226	54226U	189.5	133	160	195	49	51.9	57	63	140	18	17	130	160	1.5	1	7.72	9.29
	225	130	—	—	2.1	1.1	413	1 030	32.5	650	1 000	52326	—	—	224	134	—	—	80	—	—	—	—	30	—	130	177	2	1	22.1	—
	280	196	—	—	4	2	650	1 680	52.2	450	700	52428	—	—	279	144	—	—	120	—	—	—	—	44	—	140	206	3	2	60.6	—
120	200	81	86.2	99	1.5	1.1	234	669	19.6	940	1 450	52228	54228	54228U	199.5	143	170	210	49.5	52.1	58.5	83.5	160	18	17	140	170	1.5	1	8.31	10.5
	240	140	—	—	2.1	1.1	458	1 130	36.9	620	950	52328	—	—	239	144	—	—	85.5	—	—	—	—	31	—	140	190	2	1	27.8	—
	300	209	—	—	4	2	711	1 910	57.4	420	650	52430	—	—	299	154	—	—	127.5	—	—	—	—	46	—	150	225	3	2	73.9	—
130	215	89	95.6	109	1.5	1.1	266	768	21.8	840	1 300	52230	54230	54230U	214.5	153	180	225	54.5	57.8	64.5	74.5	160	20	20.5	150	180	1.5	1	10.6	13.6
	250	140	—	—	2.1	1.1	451	1 200	36.0	580	900	52330	—	—	249	154	—	—	85.5	—	—	—	—	31	—	150	200	2	1	29.2	—
	320	226	—	—	5	2	852	2 410	70.3	390	600	52432	—	—	319	164	—	—	138	—	—	—	—	50	—	160	240	4	2	90.3	—
135	340	236	—	—	5	2.1	943	2 730	77.2	360	550	52434	—	—	339	174	—	—	143	—	—	—	—	50	—	170	255	4	2	108	—
140	225	90	97.4	110	1.5	1.1	279	803	23.4	810	1 250	52232	54232	54232U	224.5	163	190	235	55	58.7	65	70	160	20	21	160	190	1.5	1	12.2	14.6
	270	153	—	—	3	1.1	512	1 570	41.3	550	850	52332	—	—	269	164	—	—	93	—	—	—	—	33	—	160	215	2.5	1	37.7	—
	360	245	—	—	5	3	928	2 730	75.1	320	500	52436	—	—	359	184	—	—	148.5	—	—	—	—	52	—	180	270	4	2.5	126	—
150	240	97	104.4	117	1.5	1.1	326	874	26.3	750	1 150	52234	54234	54234U	239.5	173	200	250	59	62.7	69	87	180	21	21.5	170	200	1.5	1	15.2	17.8
	250	98	102.4	118	1.5	2	332	986	26.9	710	1 100	52236	54236	54236U	249	183	210	260	59.5	61.7	69.5	108.5	200	21	21.5	180	210	1.5	2	15.9	19.6
	280	153	—	—	3	1.1	579	1 570	47.4	520	800	52334	—	—	279	174	—	—	93	—	—	—	—	33	—	170	220	2.5	1	39.6	—
	300	165	—	—	3	2	578	1 580	46.2	490	750	52336	—	—	299	184	—	—	101	—	—	—	—	37	—	180	240	2.5	2	50.9	—
160	270	109	116.4	131	2	2	385	1 010	31.4	650	1 000	52238	54238	54238U	269	194	220	280	66.5	70.2	77.5	93.5	200	24	23	190	230	2	2	21.6	25.2
	320	183	—	—	4	2	679	1 950	55.3	440	680	52338	—	—	319	195	—	—	111.5	—	—	—	—	40	—	190	255	3	2	64.9	—
170	280	109	115.6	133	2	2	392	1 110	32.2	620	950	52240	54240	54240U	279	204	240	290	66.5	69.8	78.5	120.5	225	24	23	200	240	2	2	22.7	27.3
	340	192	—	—	4	2	745	2 220	61.1	420	650	52340	—	—	339	205	—	—	117	—	—	—	—	42	—	200	270	3	2	77.8	—
190	300	110	115.2	134	2	2	428	1 310	36.6	580	900	52244	54244	54244U	299	224	260	310	67	69.6	79	114	225	24	25	220	260	2	2	23.9	29.5

[Remark] Standard cage types used for the above bearings are described earlier in this section.

## Spherical thrust roller bearings

### Spherical thrust roller bearings



Bore diameter **60 – 500 mm**

Spherical thrust roller bearings are designed to carry high axial loads. They can also support radial load if magnitude is no more than 55 % of the axial load being carried.

These bearings are not suitable for high-speed rotation.

Having a spherical housing race raceway surface, these bearings are self-aligning, adjusting to axial inclination.

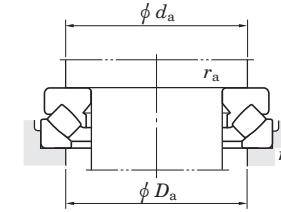
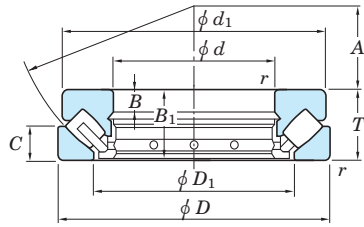
They are usually used with oil lubrication.



Boundary dimensions	As specified in JIS B 1512.
Tolerances	As specified in JIS B 1514-2, class 0. (refer to table 7-10 on p. A 75.)
Recommended fits	Refer to Table 9-8 on p. A 98.
Required minimum axial load	A certain degree of load is necessary in order for bearings to operate satisfactorily. (refer to p. A 116.)
Standard cage	Copper alloy machined cage (supplementary code : FY)
Allowable aligning angle	0.035 – 0.052 rad (2° – 3°) in general, depending on bearing series.
Equivalent axial load	Dynamic equivalent axial load $P_a = 1.2F_r + F_a$ Static equivalent axial load $P_{0a} \doteq 2.7F_r + F_a$ (Note : $F_r / F_a \leq 0.55$ )

Spherical thrust roller bearings

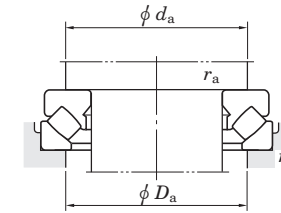
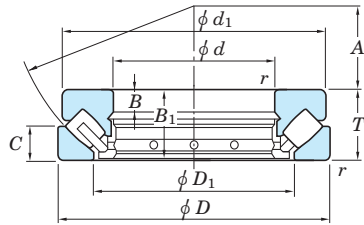
$d$  60 ~ 160 mm



Boundary dimensions (mm)				Basic load ratings (kN)		Limiting speed (min <sup>-1</sup> )	Bearing No.	Dimensions (mm)						Mounting dimensions (mm)			(Refer.) Mass (kg)
$d$	$D$	$T$	$r_{min.}$	$C_a$	$C_{0a}$	Oil lub.		$d_1$	$D_1$	$B$	$B_1$	$C$	$A$	$d_a$ min.	$D_a$ max.	$r_a$ max.	
<b>60</b>	130	42	1.5	399	884	2 700	<b>29412R</b>	123	89	15	39.5	20	38	90	108	1.5	2.75
<b>65</b>	140	45	2	450	1 020	2 500	<b>29413R</b>	133	96	16	42.5	21	42	100	115	2	3.41
<b>70</b>	150	48	2	485	1 100	2 300	<b>29414R</b>	142	103	17	45.5	23	44	105	125	2	4.16
<b>75</b>	160	51	2	584	1 360	2 100	<b>29415R</b>	152	109	18	48	24	47	115	132	2	4.98
<b>80</b>	170	54	2.1	631	1 480	2 000	<b>29416R</b>	162	117	19	51	26	50	120	140	2	5.95
<b>85</b>	150	39	1.5	400	1 000	2 600	<b>29317R</b>	143.5	114	13	37	19	50	115	135	1.5	2.87
	180	58	2.1	714	1 700	1 900	<b>29417R</b>	170	125	21	55	28	54	130	150	2	7.19
<b>90</b>	155	39	1.5	412	1 050	2 500	<b>29318R</b>	148.5	117	13	37	19	52	120	140	1.5	3.06
	190	60	2.1	821	2 010	1 800	<b>29418R</b>	180	132	22	57	29	56	135	157	2	8.28
<b>100</b>	170	42	1.5	481	1 270	2 300	<b>29320R</b>	163	129	14	40	20.8	58	130	150	1.5	3.91
	210	67	3	911	2 220	1 650	<b>29420R</b>	200	146	24	64	32	62	150	175	2.5	11.2
<b>110</b>	190	48	2	628	1 690	2 000	<b>29322R</b>	182	143	16	45.5	23	64	145	165	2	5.67
	230	73	3	1 120	2 810	1 500	<b>29422R</b>	220	162	26	69	35	69	165	190	2.5	14.7
<b>120</b>	210	54	2.1	759	2 030	1 800	<b>29324R</b>	200	159	18	51	26	70	160	180	2	7.90
	250	78	4	1 300	3 270	1 350	<b>29424R</b>	236	174	29	74	37	74	180	205	3	18.5
<b>130</b>	225	58	2.1	894	2 440	1 700	<b>29326R</b>	215	171	19	55	28	76	170	195	2	9.45
	270	85	4	1 490	3 870	1 250	<b>29426R</b>	255	189	31	81	41	81	195	225	3	23.5
<b>140</b>	240	60	2.1	898	2 490	1 600	<b>29328R</b>	230	183	20	57	29	82	185	205	2	11.1
	280	85	4	1 560	4 080	1 250	<b>29428R</b>	268	199	31	81	41	86	205	235	3	24.6
<b>150</b>	250	60	2.1	965	2 740	1 550	<b>29330R</b>	240	194	20	57	29	87	195	215	2	11.7
	300	90	4	1 730	4 620	1 100	<b>29430R</b>	285	214	32	86	44	92	220	250	3	29.6
<b>160</b>	270	67	3	1 150	3 070	1 400	<b>29332R</b>	260	208	23	64	32	92	210	235	2.5	15.4
	320	95	5	1 990	5 370	1 050	<b>29432R</b>	306	229	34	91	45	99	230	265	4	35.9

Spherical thrust roller bearings

$d$  170 ~ 320 mm

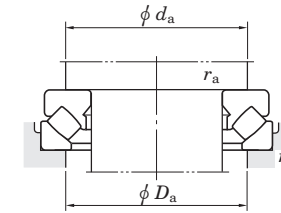
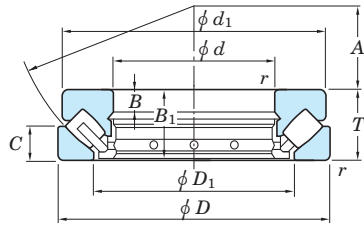


Boundary dimensions (mm)				Basic load ratings (kN)		Limiting speed (min <sup>-1</sup> )	Bearing No.	Dimensions (mm)						Mounting dimensions (mm)			(Refer.) Mass (kg)
$d$	$D$	$T$	$r_{min.}$	$C_a$	$C_{0a}$	Oil lub.		$d_1$	$D_1$	$B$	$B_1$	$C$	$A$	$d_a$ min.	$D_a$ max.	$r_a$ max.	
170	280	67	3	1 190	3 180	1 350	29334R 29434R	270	216	23	64	32	96	220	245	2.5	15.4
	340	103	5	2 180	5 880	950		324	243	37	99	50	104	245	285	4	44.0
180	300	73	3	1 380	3 170	1 250	29336R 29436R	290	232	25	69	35	103	235	260	2.5	20.7
	360	109	5	2 450	6 590	900		342	255	39	105	52	110	260	300	4	52.2
190	320	78	4	1 570	4 230	1 150	29338R 29438R	308	246	27	74	38	110	250	275	3	25.1
	380	115	5	2 790	7 690	850		360	271	41	111	55	117	275	320	4	61.4
200	280	48	2	641	2 170	1 600	29240 29340R 29440R	271	236	15	45	24	108	235	255	2	8.90
	340	85	4	1 810	5 040	1 050		325	261	29	81	41	116	265	295	3	31.2
	400	122	5	3 060	8 470	800		380	286	43	117	59	122	290	335	4	73.0
220	300	48	2	670	2 340	1 550	29244 29344R 29444R	292	254	15	45	24	117	260	275	2	10.0
	360	85	4	1 840	5 240	1 000		345	280	29	81	41	125	285	315	3	33.3
	420	122	6	3 160	8 990	750		400	308	43	117	58	132	310	355	5	74.2
240	340	60	2.1	1 030	3 670	1 250	29248 29348A 29448R	330	283	19	57	30	130	285	305	2	16.7
	380	85	4	1 790	5 330	950		365	300	29	81	41	135	300	330	3	35.5
	440	122	6	3 260	9 510	700		420	326	43	117	59	142	330	375	5	83.0
260	360	60	2.1	1 050	3 720	1 200	29252 29352 29452R	350	302	19	57	30	139	305	325	2	18.5
	420	95	5	1 960	6 040	850		405	329	32	91	45	148	330	365	4	51.5
	480	132	6	3 760	11 100	650		460	357	48	127	64	154	360	405	5	110
280	380	60	2.1	1 030	3 730	1 150	29256 29356 29456R	370	323	19	57	30	150	325	345	2	19.5
	440	95	5	2 200	6 870	800		423	348	32	91	46	158	350	390	4	53.2
	520	145	6	4 560	13 600	550		495	387	52	140	68	166	390	440	5	137
300	420	73	3	1 330	4 880	950	29260 29360 29460R	405	353	21	69	38	162	355	380	2.5	30.5
	480	109	5	2 470	7 780	700		460	379	37	105	50	168	380	420	4	74.9
	540	145	6	4 670	14 900	550		515	402	52	140	70	175	410	460	5	146
320	440	73	3	1 780	6 480	900	29264R 29364 29464R	430	372	21	69	38	172	375	400	2.5	32.7
	500	109	5	2 890	9 380	650		482	399	37	105	53	180	400	440	4	78.0
	580	155	7.5	5 190	16 100	500		555	435	55	149	75	191	435	495	6	179



Spherical thrust roller bearings

$d$  340 ~ 500 mm



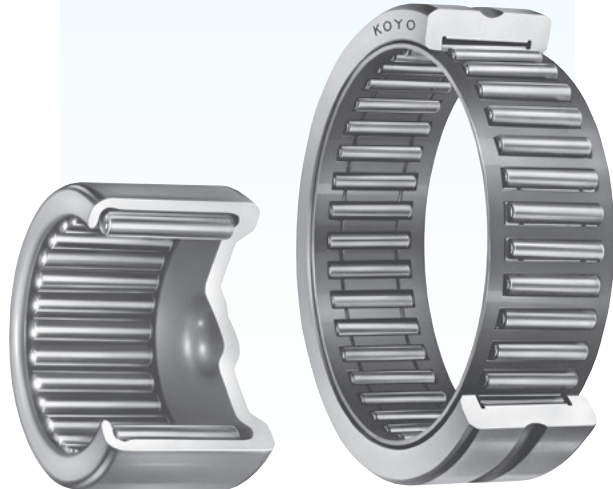
Boundary dimensions (mm)				Basic load ratings (kN)		Limiting speed (min <sup>-1</sup> )	Bearing No.	Dimensions (mm)						Mounting dimensions (mm)			(Refer.) Mass (kg)
$d$	$D$	$T$	$r_{min.}$	$C_a$	$C_{0a}$	Oil lub.		$d_1$	$D_1$	$B$	$B_1$	$C$	$A$	$d_a$ min.	$D_a$ max.	$r_a$ max.	
340	460	73	3	1 800	6 420	900	29268R 29368R 29468R	445	395	21	69	37	183	395	420	2.5	34.7
	540	122	5	3 810	12 700	600		520	428	41	117	59	192	430	470	4	106
	620	170	7.5	6 190	19 400	450		590	462	61	164	82	201	465	530	6	224
360	500	85	4	1 650	6 080	750	29272 29372R 29472R	485	423	25	81	44	194	420	455	3	51.8
	560	122	5	3 890	13 200	550		540	448	41	117	59	202	450	495	4	110
	640	170	7.5	6 440	20 600	450		610	480	61	164	82	210	485	550	6	231
380	520	85	4	1 750	6 610	700	29276 29376R 29476R	505	441	27	81	42	202	440	475	3	52.8
	600	132	6	4 430	15 000	500		580	477	44	127	63	216	480	525	5	141
	670	175	7.5	6 780	22 000	410		640	504	63	168	85	230	510	575	6	263
400	540	85	4	1 980	7 610	700	29280 29380R 29480R	526	460	27	81	42	212	460	490	3	55.3
	620	132	6	4 630	16 100	500		596	494	44	127	64	225	500	550	5	144
	710	185	7.5	7 750	25 300	380		680	534	67	178	89	236	540	610	6	315
420	580	95	5	2 310	8 750	600	29284 29384R 29484R	564	489	30	91	46	225	490	525	4	75.4
	650	140	6	5 070	17 700	450		626	520	48	135	68	235	525	575	5	169
	730	185	7.5	7 960	26 500	370		700	556	67	178	89	244	560	630	6	330
440	600	95	5	2 340	8 970	600	29288 29388R 29488R	585	508	30	91	49	235	510	545	4	77.9
	680	145	6	5 360	18 800	420		655	548	49	140	70	245	550	600	5	190
	780	206	9.5	9 100	30 000	320		745	588	74	199	100	260	595	670	8	423
460	620	95	5	2 460	9 620	550	29292 29392 29492R	605	530	30	91	46	245	530	570	4	81.0
	710	150	6	4 580	15 800	400		685	567	51	144	72	257	575	630	5	216
	800	206	9.5	9 360	31 600	300		765	608	74	199	100	272	615	690	8	438
480	650	103	5	2 880	11 600	500	29296 29496R	635	556	33	99	55	259	555	595	4	89.0
	850	224	9.5	10 900	36 300	270		810	638	81	216	108	280	645	730	8	548
500	870	224	9.5	10 800	36 400	270	294/500R	830	661	81	216	107	290	670	750	8	562

## Needle roller bearings

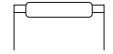
Needle roller bearings are small in sectional height, therefore useful in making machinery smaller and lighter. This type of bearing is used in a wide range of machinery, such as automobiles, motor cycles, electric machines, machine tools, aerospace and office equipment.

- Compact, highly rigid and superior in load carrying performance, compared with other types of bearings.
- Excellent for carrying oscillating loads; contains many small diameter rollers.
- Widely employed in stud type and yoke type track rollers used as guide rollers in cam mechanisms or linear motion units. Allowable loads of these truck rollers are examined with load ratings different from those of general bearings. For detailed information, contact us.  
Also used in miniature one-way clutches in the clutch mechanisms of office equipment, such as copying machines.

The catalog also covers bearings employing rollers other than those prescribed in JIS B 1506 "rollers for roller bearings".



### Needle roller and cage assemblies



Bore diameter of a needle roller and cage assembly

Metric series **3 – 110 mm**

Inch series **9.525 – 127.000 mm**

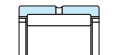
### Drawn cup needle roller bearings



Metric series Roller set bore dia. **3 – 60 mm**

Inch series Roller set bore dia. **3.175 – 69.850 mm**

### Heavy-duty needle roller bearings



Metric series Roller set bore dia. **5 – 175 mm**

Inch series Roller set bore dia. **15.875 – 88.900 mm**

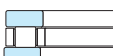
### Needle roller thrust bearings



Metric series Bore dia. **6 – 160 mm**

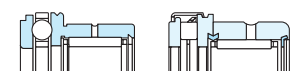
Inch series Bore dia. **6.350 – 104.780 mm**

### Cylindrical roller thrust bearings



Bore dia. **15 – 90 mm**

### Combined needle roller bearings



Roller set bore dia. **10 – 70 mm**

### Inner rings



Metric series Bore dia. **5 – 180 mm**

Inch series Bore dia. **9.525 – 76.2 mm**

### Miniature one-way clutches (Refer.)



Roller set bore dia. **4 – 12 mm**

For details, refer to JTEKT separate catalog "Needle Roller Bearings" (CAT. NO. B2020E)



**Table 1 (1) Types of needle roller bearing**

**(1) Radial Needle Roller and Cage Assemblies**

Metric Series Inch Series

Single-Row, Double-Row



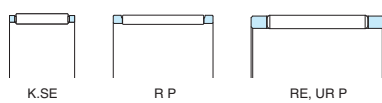
Single-Row

Metric Series

Assemblies for Crank Pin End Applications



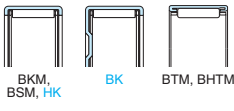
Assemblies for Wrist Pin End Applications



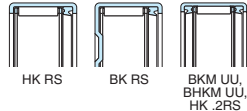
**(2) Drawn Cup Needle Roller Bearings**

Metric Series (Caged)

Open Ends, Closed One End

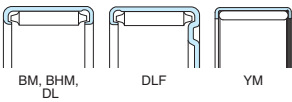


Sealed



(Full Complement)

Open Ends, Closed One End

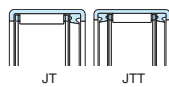


Inch Series (Caged)

Open Ends, Closed One End

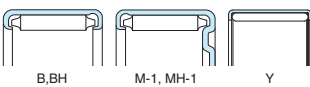


Sealed



(Full Complement)

Open Ends, Closed One End

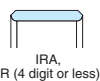


Extra-Precision



Inner Rings

Inch Series



The needle roller bearings explained in this catalog are indicated in blue. For additional details on Koyo's Needle Roller Bearing product line please refer to Catalog B2020E.

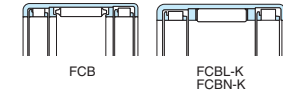
**(3) Drawn Cup Roller Clutches**

Metric Series

Clutches

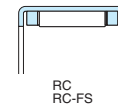


Clutch and Bearing Assemblies

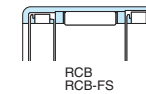


Inch Series

Clutches



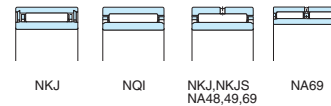
Clutch and Bearing Assemblies



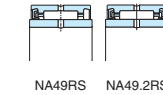
**(4) Heavy-Duty Needle Roller Bearings**

Metric Series (Caged, With Inner Ring)

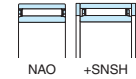
Unsealed



Sealed

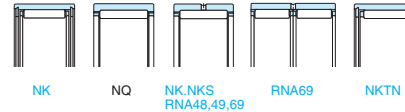


Without Flanges

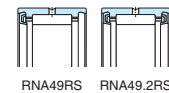


(Without Inner Ring)

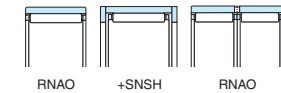
Unsealed



Sealed

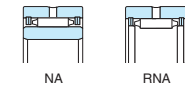


Without Flanges



(Full Complement) Inch Series (Without Inner Ring) Inner Rings

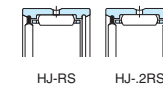
With Inner Ring Without Inner Ring



Unsealed



Sealed



Inch Series



Table 1 (2) Types of needle roller bearing

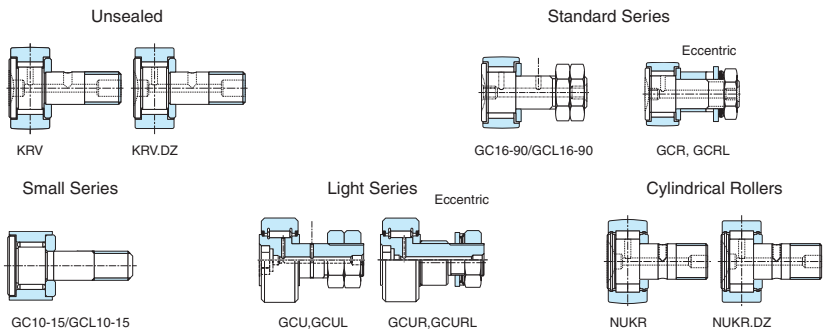
(5) Track Rollers

[Stud-Type]

Metric Series (Caged)

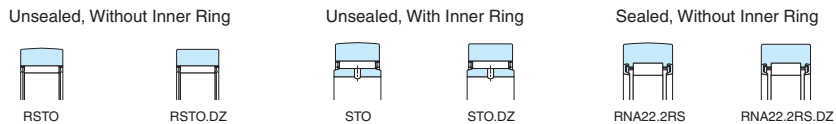


(Full Complement)

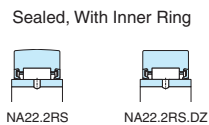


[Yoke-Type]

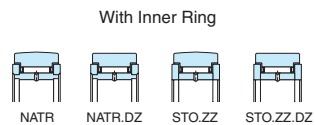
Metric Series (Caged, Without End Washers)



(Caged, Without End Washers)



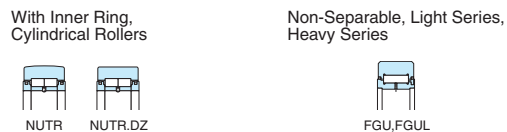
(Caged, With End Washers)



(Full Complement, With End Washers)



(Full Complement, With Metal Seals)

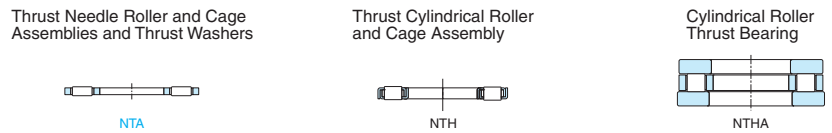


(6) Thrust Bearings, Assemblies, Washers

Metric Series

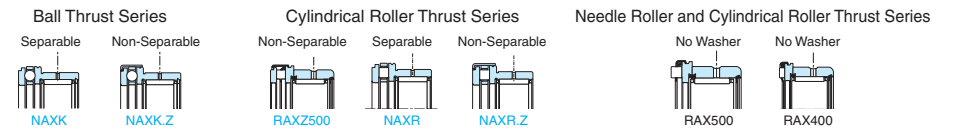


Inch Series

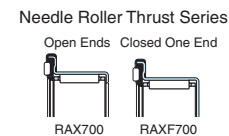


(7) Combined Needle Roller Bearings

Metric Series (Heavy-Duty, Without Inner Ring)



(Drawn Cup, Without Inner Ring)

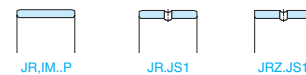


(8) Needle Rollers, Accessories

Inner Rings (Caged)

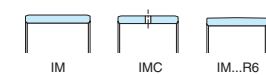
<Metric Series>

For Drawn Cup Needle Roller Bearings, Heavy-Duty

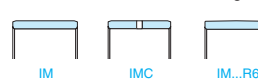


(Full Complement)

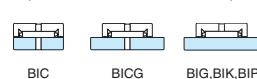
For Drawn Cup Needle Roller Bearings



For Machine-Tool Quality Precision-Combined Bearings



For RNA Bearings (With Oil Holes, Extra Wide)



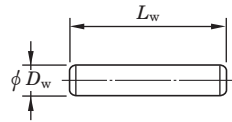
End Washer

For Metric Series NAO and RNAO Bearings



[Tolerances of needle roller bearings]

Table 2 Tolerance grades of needle rollers (JIS B 1506)



Unit :  $\mu\text{m}$

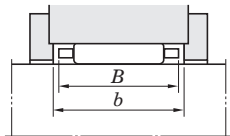
Class	Single <sup>1)</sup> plane diameter variation $V_{Dwp}$ max.	Deviation <sup>1)</sup> from circular form $\Delta_{Rw}$ max.	Gauge lot <sup>1)</sup> diameter variation $V_{DwL}$ max.
2	1	1	2
3	1.5	1.5	3
5	2	2.5	5

Class	Actual <sup>2)</sup> length deviation $\Delta_{Lws}$	Recommended gauge $S$
2	h 13	0/- 2, - 1/- 3, - 2/- 4, - 3/- 5, - 4/- 6, - 5/- 7, - 6/- 8, - 7/- 9, - 8/- 10
3		0/- 3, - 1.5/- 4.5, - 3/- 6, - 4.5/- 7.5, - 6/- 9, - 7/- 10
5		0/- 5, - 3/- 8, - 5/- 10

[Notes] 1) Values apply only at middle of roller length.  
2) Applied tolerance differs according to  $L_w$  division.

[Remark] Along the entire length of the roller, all the actually measured diameters should not exceed the actual maximum diameter at the middle of the entire length of the roller by the lengths shown below.  
a) Class 2 : 0.5  $\mu\text{m}$     b) Class 3 : 0.8  $\mu\text{m}$   
c) Class 5 : 1  $\mu\text{m}$

Table 3 Tolerance of needle roller cage width B (JIS B 1536-3)



Bearing type	B deviation (mm)	
	upper	lower
K, K...ZW	- 0.2	- 0.55
WJ, WJC	0	- 0.38

[Remark] Values in Italics are prescribed in JTEKT standards.

[Reference] The guide width (b) should satisfy the equation :  $b = B + (H11)$

Table 4 Metric series drawn cup needle roller bearing gauge specifications (caged)

Unit : mm

Nominal bore diameter	Ring gage <sup>1)</sup>	Needle roller complement bore diameter	
		max.	min.
3	6.484	3.024	3.006
4	7.984	4.028	4.010
5	8.984	5.028	5.010
6	9.984	6.028	6.010
7	10.980	7.031	7.013
8	11.980	8.031	8.013
9	12.980	9.031	9.013
10	13.980	10.031	10.013
12	15.980	12.034	12.016
12	17.980	12.034	12.016
13	18.976	13.034	13.016
14	19.976	14.034	14.016
15	20.976	15.034	15.016
16	21.976	16.034	16.016
17	22.976	17.034	17.016
18	23.976	18.034	18.016
20	25.976	20.041	20.020
22	27.976	22.041	22.020
25	31.972	25.041	25.020
28	34.972	28.041	28.020
30	36.972	30.041	30.020
35	41.972	35.050	35.025
40	46.972	40.050	40.025
45	51.967	45.050	45.025
50	57.967	50.050	50.025
60	67.967	60.060	60.030

[Note] 1) The ring gage sizes are in accordance with ISO N6 lower limit.

Table 5 Inch series drawn cup needle roller bearing gauge specifications (caged)

Unit : mm

Bearing bore designation	Nominal shaft diameter	Nominal bore diameter	Ring gage	Needle roller complement bore diameter	
				max.	min.
2	3.175	3.175	6.363	3.218	3.195
2 1/2	3.970	3.967	7.155	4.013	3.99
3	4.763	4.763	8.730	4.806	4.783
4	6.350	6.350	11.125	6.411	6.388
5	7.938	7.938	12.713	7.998	7.976
H 5	H 7.938	7.938	14.300	7.998	7.976
6	9.525	9.525	14.300	9.586	9.563
H 6	H 9.525	9.525	15.888	9.586	9.563
7	11.113	11.113	15.888	11.174	11.151
H 7	H 11.113	11.113	17.475	11.174	11.151
8	12.700	12.700	17.475	12.761	12.738
H 8	H12.700	12.700	19.063	12.761	12.738
9	14.288	14.288	19.063	14.349	14.326
H 9	H 14.288	14.288	20.650	14.349	14.326
10	15.875	15.875	20.650	14.349	15.913
H 10	H 15.875	15.875	22.238	14.349	15.913
11	17.463	17.463	22.238	17.524	17.501
H 11	H 17.463	17.463	23.825	17.524	17.501
12	19.050	19.050	25.387	19.086	19.063
H 12	H 19.050	19.050	26.975	19.086	19.063
13	20.638	20.638	26.975	20.673	20.650
H 13	H 20.638	20.638	28.562	20.673	20.650
14	22.225	22.225	28.562	22.261	22.238
H 14	H 22.225	22.225	30.150	22.261	22.238
15	23.813	23.813	30.150	23.848	23.825
16	25.400	25.400	31.737	25.436	25.413
H 16	H 25.400	25.400	33.325	25.436	25.413
17	26.988	26.988	33.325	27.023	27.000
18	28.575	28.575	34.912	28.611	28.588
H 18	H 28.575	28.575	38.087	28.611	28.588
19	30.163	30.163	38.087	30.198	30.175
20	31.750	31.750	38.087	31.786	31.763
H 20	H 31.750	31.750	41.262	31.786	31.763
21	33.338	33.338	41.262	33.376	33.350
22	34.925	34.925	41.262	34.963	34.938
H 22	H 34.925	34.925	44.437	34.963	34.938
24	38.100	38.100	47.612	38.141	38.113
26	41.275	41.275	50.787	41.316	41.288
28	44.450	44.450	53.962	44.493	44.463
30	47.625	47.625	57.137	47.668	47.638
32	50.800	50.800	60.312	50.846	50.815
H 33	H 52.388	52.388	64.280	52.436	52.400
34	53.975	53.975	63.487	54.026	53.990
36	57.150	57.150	66.662	57.201	57.165
42	66.675	66.675	76.187	66.736	66.700
44	69.850	69.850	79.362	69.911	69.875
56	88.900	88.900	101.587	88.961	88.925
88	139.700	139.700	152.375	139.774	139.725

[Remark] Bearing bore should be checked with "go" and "no go" plug gages. The "go" gage size is the minimum needle roller complement bore diameter. The "no go" gage size is larger than the maximum needle roller complement bore diameter by 0.0001 in.

Table 6 Metric series caged needle roller complement bore diameter for bearings without inner rings

Unit : mm

$F_w$		$\Delta F_{w \text{ min.}}$	
over	up to	max.	min.
3	6	+ 0.018	+ 0.010
6	10	+ 0.022	+ 0.013
10	18	+ 0.027	+ 0.016
18	30	+ 0.033	+ 0.020
30	50	+ 0.041	+ 0.025
50	80	+ 0.049	+ 0.030
80	120	+ 0.058	+ 0.036
120	180	+ 0.068	+ 0.043
180	250	+ 0.079	+ 0.050
250	315	+ 0.088	+ 0.056
315	400	+ 0.098	+ 0.062

Table 7 Metric series heavy-duty needle roller bearing tolerances = JIS B 1415 (ISO 492) =

(1) Inner ring

Unit : μm

Nominal bore diameter <i>d</i> (mm)		Single plane mean bore diameter deviation $\Delta_{dmp}$						Single plane bore diameter variation $V_{dsp}$			Mean bore diameter variation $V_{dmp}$			Radial runout of assembled bearing inner ring $K_{ia}$			$S_d$	Single inner ring width deviation $\Delta B_s$						Inner ring width variation $V_{Bs}$		
		class 0		class 6		class 5		class 0	class 6	class 5								class 0	class 6	class 5	class 5	class 0		class 6		class 5
		upper	lower	upper	lower	upper	lower	max.	max.	max.	max.	max.	max.	upper	lower	upper	lower	upper	lower	max.	max.	max.				
2.5	10	0	-8	0	-7	0	-5	10	9	5	6	5	3	10	6	4	7	0	-120	0	-120	0	-40	15	15	5
10	18	0	-8	0	-7	0	-5	10	9	5	6	5	3	10	7	4	7	0	-120	0	-120	0	-80	20	20	5
18	30	0	-10	0	-8	0	-6	13	10	6	8	6	3	13	8	4	8	0	-120	0	-120	0	-120	20	20	5
30	50	0	-12	0	-10	0	-8	15	13	8	9	8	4	15	10	5	8	0	-120	0	-120	0	-120	20	20	5
50	80	0	-15	0	-12	0	-9	19	15	9	11	9	5	20	10	5	8	0	-150	0	-150	0	-150	25	25	6
80	120	0	-20	0	-15	0	-10	25	19	10	15	11	5	25	13	6	9	0	-200	0	-200	0	-200	25	25	7
120	150	0	-25	0	-18	0	-13	31	23	13	19	14	7	30	18	8	10	0	-250	0	-250	0	-250	30	30	8
150	180	0	-25	0	-18	0	-13	31	23	13	19	14	7	30	18	8	10	0	-250	0	-250	0	-250	30	30	8
180	250	0	-30	0	-22	0	-15	38	28	15	23	17	8	40	20	10	11	0	-300	0	-300	0	-300	30	30	10

$S_d$  : Perpendicularity of inner ring face with respect to the bore

(2) Outer ring

Unit : μm

Nominal outside diameter <i>D</i> (mm)		Single plane mean outside diameter deviation $\Delta_{Dmp}$						Single plane outside diameter variation $V_{Dsp}$			Mean outside diameter variation $V_{Dmp}$			Radial runout of assembled bearing outer ring $K_{ea}$			$S_D$	$\Delta C_s$		Ring width variation $V_{Cs}$				
		class 0		class 6		class 5		class 0 <sup>1)</sup>	class 6 <sup>1)</sup>	class 5										class 0 <sup>1)</sup>	class 6 <sup>1)</sup>	class 5	class 5	class 0, 6, 5
		upper	lower	upper	lower	upper	lower	max.	max.	max.	max.	max.	max.	max.	upper	lower	max.	max.	max.					
6	18	0	-8	0	-7	0	-5	10	9	5	6	5	3	15	8	5	8					5		
18	30	0	-9	0	-8	0	-6	12	10	6	7	6	3	15	9	6	8					5		
30	50	0	-11	0	-9	0	-7	14	11	7	8	7	4	20	10	7	8					5		
50	80	0	-13	0	-11	0	-9	16	14	9	10	8	5	25	13	8	8	Shall conform to the tolerance $\Delta B_s$ on <i>d</i> of the same bearing	Shall conform to the tolerance $V_{Bs}$ on <i>d</i> of the same bearing			6		
80	120	0	-15	0	-13	0	-10	19	16	10	11	10	5	35	18	10	9							8
120	150	0	-18	0	-15	0	-11	23	19	11	14	11	6	40	20	11	10							8
150	180	0	-25	0	-18	0	-13	31	23	13	19	14	7	45	23	13	10							8
180	250	0	-30	0	-20	0	-15	38	25	15	23	15	8	50	25	15	11					10		
250	315	0	-35	0	-25	0	-18	44	31	18	26	19	9	60	30	18	13					11		

[Note] 1) Shall be applied when locating snap ring is not fitted.

$S_D$  : Perpendicularity of outer ring outside surface with respect to the face

$\Delta C_s$  : Deviation of a single outer ring width

**Table 8 Inch series heavy-duty needle roller bearing (HJ outer ring)**

(1) Outside diameter and width tolerances Unit : mm				(2) Roller complement bore tolerance Unit : mm					
Nominal outside diameter $D$		Single plane mean outside diameter deviation ( $D_{mp}$ ) <sup>1)</sup>		Deviation from nominal of width (C)		Nominal roller complement bore diameter $F_w$		Deviation from nominal of the smallest single diameter of the roller complement bore ( $F_m$ ) <sup>1)</sup>	
over	up to	max.	min.	max.	min.	over	up to	max.	min.
19.050	50.800	+0	-0.013			12.700	15.875	+0.043	+0.020
50.800	82.550	+0	-0.015	+0	-0.013	15.875	28.575	+0.046	+0.023
82.550	120.650	+0	-0.020			28.575	41.275	+0.048	+0.025
						41.275	47.625	+0.050	+0.025
						47.625	69.850	+0.053	+0.028
						69.850	76.200	+0.058	+0.028
						76.200	101.600	+0.060	+0.030

[Note] 1) "Single mean diameter" is defined as the mean diameter in a single radial plane.

[Note] 1) "The smallest single diameter of the roller complement bore" is defined as the diameter of the cylinder which, when used as a bearing inner ring, results in zero radial internal clearance in the bearing on at least one diameter.

**Table 9 Inch series heavy-duty needle roller bearing (IR inner ring)**

(1) Bore and width tolerances Unit : mm				(2) Outside diameter tolerance Unit : mm					
Nominal bore diameter $d$		Single plane mean bore diameter deviation ( $d_{mp}$ ) <sup>1)</sup>		Deviation from nominal of width (B)		Nominal outside diameter $F$		Single plane mean outside diameter deviation ( $F_{mp}$ ) <sup>1)</sup>	
over	up to	max.	min.	max.	min.	over	up to	max.	min.
7.938	19.050	+0	-0.010			12.700	15.875	-0.013	-0.023
19.050	50.800	+0	-0.013	+0.25	+0.12	15.875	25.400	-0.018	-0.031
50.800	82.550	+0	-0.015			25.400	28.575	-0.023	-0.036
						28.575	34.925	-0.023	-0.036
						34.925	47.625	-0.025	-0.038
						47.625	76.200	-0.028	-0.040
						76.200	95.250	-0.033	-0.046

[Note] 1) "Single mean diameter" is defined as the mean diameter in a single radial plane.

[Note] 1) "Single mean diameter" is defined as the mean diameter in a single radial plane.

**Table 10 Tolerance for metric series thrust needle roller and cage assemblies (type code : FNT)**

(1) Bore diameter Unit : mm				(2) Outside diameter Unit : mm			
Nominal bore diameter $D_{c1}$		Smallest single bore diameter deviation (E11)		Nominal outside diameter $D_c$		Largest single outside diameter deviation (c12)	
over	up to	upper	lower	over	up to	upper	lower
3	6	+0.095	+0.020	18	30	-0.110	-0.320
6	10	+0.115	+0.025	30	40	-0.120	-0.370
10	18	+0.142	+0.032	40	50	-0.130	-0.380
18	30	+0.170	+0.040	50	65	-0.140	-0.440
30	50	+0.210	+0.050	65	80	-0.150	-0.450
50	80	+0.250	+0.060	80	100	-0.170	-0.520
80	120	+0.292	+0.072	100	120	-0.180	-0.530
120	180	+0.335	+0.085	120	140	-0.200	-0.600
				140	160	-0.210	-0.610
				160	180	-0.230	-0.630
				180	200	-0.240	-0.700

**Table 11 Tolerance for metric series thrust needle roller and cage assemblies (type code : AXK)**

(1) Bore diameter Unit : mm				(2) Outside diameter Unit : mm			
Nominal bore diameter $D_{c1}$		Smallest single bore diameter deviation (E12)		Nominal outside diameter $D_c$		Largest single outside diameter deviation (c13)	
over	up to	upper	lower	over	up to	upper	lower
3	6	+0.140	+0.020	18	30	-0.110	-0.440
6	10	+0.175	+0.025	30	40	-0.120	-0.510
10	18	+0.212	+0.032	40	50	-0.130	-0.520
18	30	+0.250	+0.040	50	65	-0.140	-0.600
30	50	+0.300	+0.050	65	80	-0.150	-0.610
50	80	+0.360	+0.060	80	100	-0.170	-0.710
80	120	+0.422	+0.072	100	120	-0.180	-0.720
120	180	+0.485	+0.085	120	140	-0.200	-0.830
				140	160	-0.210	-0.840
				160	180	-0.230	-0.860
				180	200	-0.240	-0.960

**Table 12 Tolerance for metric series thrust washers (type code : AS series)**

(1) Bore diameter Unit : mm				(2) Outside diameter Unit : mm			
Nominal bore diameter $d$		Smallest single bore diameter deviation (E13)		Nominal outside diameter $d_1$		Largest single outside diameter deviation (e13)	
over	up to	upper	lower	over	up to	upper	lower
3	6	+0.200	+0.020	18	30	-0.040	-0.370
6	10	+0.245	+0.025	30	50	-0.050	-0.440
10	18	+0.302	+0.032	50	80	-0.060	-0.520
18	30	+0.370	+0.040	80	120	-0.072	-0.612
30	50	+0.440	+0.050	120	180	-0.085	-0.715
50	80	+0.520	+0.060	180	250	-0.100	-0.820
80	120	+0.612	+0.072				
120	180	+0.715	+0.085				

**Table 13 Tolerance for metric series thrust washers (type code : LS series)**

(1) Bore diameter Unit : mm				(2) Outside diameter Unit : mm			
Nominal bore diameter $d$		Smallest single bore diameter deviation (E12)		Nominal outside diameter $d_1$		Largest single outside diameter deviation (a12)	
over	up to	upper	lower	over	up to	upper	lower
3	6	+0.140	+0.020	18	30	-0.300	-0.510
6	10	+0.175	+0.025	30	40	-0.310	-0.560
10	18	+0.212	+0.032	40	50	-0.320	-0.570
18	30	+0.250	+0.040	50	65	-0.340	-0.640
30	50	+0.300	+0.050	65	80	-0.360	-0.660
50	80	+0.360	+0.060	80	100	-0.380	-0.730
80	120	+0.422	+0.072	100	120	-0.410	-0.760
120	180	+0.485	+0.085	120	140	-0.460	-0.860
				140	160	-0.520	-0.920
				160	180	-0.580	-0.980
				180	200	-0.660	-1.120

[Remark] Thickness tolerances for series LS heavy thrust washers are given in bearing tables.

**Table 14 Tolerance for metric series shaft piloted washers of thrust bearings (type code : WS.811 and WS.812)**

Unit : mm

Nominal bore diameter <i>d</i>		Tolerance class P0				Tolerance class P6				Tolerance class P5			
		Deviations $\Delta_{dmp}$		Variation $V_{dsp}$	$S_i^{(1)}$	Deviations $\Delta_{dmp}$		Variation $V_{dsp}$	$S_i^{(1)}$	Deviations $\Delta_{dmp}$		Variation $V_{dsp}$	$S_i^{(1)}$
		upper	lower	max.		min.	upper	lower		max.	min.	upper	
over	up to												
	<b>18</b>	+0	-0.008	0.006	0.010	+0	-0.008	0.006	0.005	+0	-0.008	0.006	0.003
<b>18</b>	<b>30</b>	+0	-0.010	0.008	0.010	+0	-0.010	0.008	0.005	+0	-0.010	0.008	0.003
<b>30</b>	<b>50</b>	+0	-0.012	0.009	0.010	+0	-0.012	0.009	0.006	+0	-0.012	0.009	0.003
<b>50</b>	<b>80</b>	+0	-0.015	0.011	0.010	+0	-0.015	0.011	0.007	+0	-0.015	0.011	0.004
<b>80</b>	<b>120</b>	+0	-0.020	0.015	0.015	+0	-0.020	0.015	0.008	+0	-0.020	0.015	0.004
<b>120</b>	<b>180</b>	+0	-0.025	0.019	0.015	+0	-0.025	0.019	0.009	+0	-0.025	0.019	0.005
<b>180</b>	<b>250</b>	+0	-0.030	0.023	0.020	+0	-0.030	0.023	0.010	+0	-0.030	0.023	0.005
<b>250</b>	<b>315</b>	+0	-0.035	0.026	0.025	+0	-0.035	0.026	0.013	+0	-0.035	0.026	0.007
<b>315</b>	<b>400</b>	+0	-0.040	0.030	0.030	+0	-0.040	0.030	0.015	+0	-0.040	0.030	0.007
<b>400</b>	<b>500</b>	+0	-0.045	0.034	0.030	+0	-0.045	0.034	0.018	+0	-0.045	0.034	0.009

[Note] 1) The values of the wall thickness variation  $S_{e1}$  for the housing piloted washer are identical to  $S_i$  for the shaft - piloted washers.

$\Delta_{dmp}$  : Single plane mean bore diameter deviation

$V_{dsp}$  : Single plane bore diameter variation

$S_i$  : Wall thickness variation

**Table 15 Tolerance for metric series housing piloted washers of thrust bearings (type code : GS.811 and GS.812)**

Unit : mm

Nominal outside diameter <i>D</i>		Tolerance class P0			Tolerance class P6			Tolerance class P5		
		Deviations $\Delta_{Dmp}$		Variation $V_{Dsp}$	Deviations $\Delta_{Dmp}$		Variation $V_{Dsp}$	Deviations $\Delta_{Dmp}$		Variation $V_{Dsp}$
		upper	lower	max.	upper	lower	max.	upper	lower	max.
over	up to									
	<b>30</b>	+0	-0.013	0.010	+0	-0.013	0.010	+0	-0.013	0.010
<b>30</b>	<b>50</b>	+0	-0.016	0.012	+0	-0.016	0.012	+0	-0.016	0.012
<b>50</b>	<b>80</b>	+0	-0.019	0.014	+0	-0.019	0.014	+0	-0.019	0.014
<b>80</b>	<b>120</b>	+0	-0.022	0.017	+0	-0.022	0.017	+0	-0.022	0.017
<b>120</b>	<b>180</b>	+0	-0.025	0.019	+0	-0.025	0.019	+0	-0.025	0.019
<b>180</b>	<b>250</b>	+0	-0.030	0.023	+0	-0.030	0.023	+0	-0.030	0.023
<b>250</b>	<b>315</b>	+0	-0.035	0.026	+0	-0.035	0.026	+0	-0.035	0.026
<b>315</b>	<b>400</b>	+0	-0.040	0.030	+0	-0.040	0.030	+0	-0.040	0.030
<b>400</b>	<b>500</b>	+0	-0.045	0.034	+0	-0.045	0.034	+0	-0.045	0.034

[Note]  $\Delta_{Dmp}$  : Single plane mean outside diameter deviation

$V_{Dsp}$  : Single plane outside diameter variation

**Table 16 Tolerance for inch series thrust needle roller and cage assemblies (type code : NTA)**

Unit : mm

Needle roller diameter (nominal) $D_w$	Deviations			
	Bore diameter $D_{c1}$		Outside diameter $D_c$	
	upper	lower	upper	lower
1.981	+0.178	+0.051	-0.254	-0.508
3.175	+0.254	+0.051	-0.254	-0.635

**Table 17 Tolerance for inch series thrust washers (type code : TRA, TRB, etc.)**

(1) Bore diameter Unit : mm

Nominal bore diameter <i>d</i>		Deviations	
over	up to	upper	lower
<b>6.000</b>	<b>57.200</b>	+0.300	+0.050
<b>57.200</b>	<b>133.400</b>	+0.430	+0.050

(2) Outside diameter Unit : mm

Nominal Outside diameter $d_1$		Deviations	
over	up to	upper	lower
<b>6.000</b>	<b>133.400</b>	-0.025	-0.760

**Table 18 Tolerance for combined needle roller bearings (thrust component thickness ( $C_1$ ))**

Unit : mm

Bearing series	Tolerance	
	upper	lower
NAXK, NAXK.Z	+0	-0.200
NAXR, NAXR.Z	+0	-0.200
RAXZ	+0.100	-0.110



[Recommended fit and internal clearance]

**Table 19 Recommended fit for metric series radial needle roller and cage assemblies**

Condition	Tolerance zone class		Housing bore
	Shaft		
Radial clearance	$F_w \leq 50 \text{ mm}$	$F_w > 50 \text{ mm}$	
Smaller than normal	j 5	h 5	G 6
Normal	h 5	g 5	
Larger than normal	g 6	f 6	

**Table 20 Recommended fit for metric series drawn cup needle roller bearings**

Bearing type	Operating condition	Shaft fit (recommended internal radial clearances)	Housing fit (recommended internal radial clearances)
HK, BK (caged)	One piece heavy section steel or cast iron housing	h5 (h6)	N6 (N7)
	Housing material of low rigidity	h5 (h6)	R6 (R7)
	Outer ring rotation (one piece heavy section steel or cast iron housing)	f5 (f6)	R6 (R7)
	Oscillating Motion	j5 (j6)	<sup>1)</sup>

[Note] <sup>1)</sup> Tolerance dependent on housing design.  
 [Remark] When the bearing is provided with an inner ring, the shaft tolerance class h5 should be selected.

**Table 23 Recommended fit for metric series needle roller thrust bearings**

Bearing components	Shaft tolerance (shaft piloting)	Housing tolerance (housing piloting)
Needle roller and cage assembly. Types : AXK, FNT	h8	H8
Thin thrust washer. Type : AS	h8	H8
Heavy thrust washer. Type : LS	h8	H8
Shaft-piloted thrust washer. Type : WS.811	h6 (j6)	Clearance
Housing-piloted thrust washer. Type : GS.811	Clearance	H7 (K7)

**Table 24 Recommended fit for metric series cylindrical roller thrust bearings**

Bearing components	Shaft tolerance (shaft piloting)	Housing tolerance (housing piloting)	Piloting components
Thrust cylindrical roller and cage assembly. Types : K.811 and K.812	h8	H10	Shaft
Heavy thrust washer. Type : LS	h10	H11	Shaft
Shaft-piloted thrust washer. Types : WS.811, WS.812	h6 (j6)	Clearance	Shaft
Housing-piloted thrust washer. Types : GS.811, GS.812	Clearance	H7 (K7)	Housing

**Table 21 Recommended fit for inch series drawn cup needle roller bearings**

Bearing design	Shaft			Housing		
	Classification	max.	min.	Classification	max.	min.
J, JTT <sup>1)</sup>	$F_w \leq 5.556 \text{ mm (7/32")}$	0	-0.008 mm (-0.0003")	$D \leq 7.144 \text{ mm (9/32")}$	+0.013 mm (-0.0005")	0
	$5.556 \text{ mm (7/32")} < F_w \leq 50.006 \text{ mm (1 31/32")}$	0	-0.013 mm (-0.0005")			
	$50.006 \text{ mm (1 31/32")} < F_w \leq 119.856 \text{ mm (4 23/32")}$	0	-0.015 mm (-0.0006")	$7.144 \text{ mm (9/32")} < D$	+0.013 mm (-0.0005")	+0.013 mm (-0.0005")
	$119.856 \text{ mm (4 23/32")} < F_w \leq 180.181 \text{ mm (7 3/32")}$	0	-0.018 mm (-0.0007")			

[Note] <sup>1)</sup> Special fits  
 When  $D = 8.733 \text{ mm (0.3438")}$  : housing fit : -0.003 mm (-0.0001") maximum, -0.015 mm (-0.0006") minimum  
 When  $D = 22.212 \text{ mm (0.8745")}$  : housing fit : +0.025 mm (+0.0010") maximum, 0 mm (0") minimum  
 When  $D = 152.400 \text{ mm (6.0000")}$  : housing fit : +0.025 mm (+0.0010") maximum, -0.025 mm (-0.0010") minimum

**Table 22 Recommended fit for metric series heavy-duty needle roller bearings**

**Without inner ring**

Rotation conditions	Nominal housing bore diameter $D$ (mm)	ISO tolerance zone for housing		Nominal shaft diameter $F'$ shaft (mm)	ISO tolerance zone for shaft	
		caged	full		caged	full
Load stationary relative to housing	all diameters	H7 (J7)	J6	all diameters	h6 (h5)	h5
General work with larger clearance		K7	—		g6	—
Load rotates relative to housing		N7	M6		f6	g5

[Remark] Care should be taken that the selected bearing internal clearance is appropriate for the operating conditions.



[Shaft and housing specifications]

**Table 25 Specifications of shafts and housings (needle roller and cage assemblies, drawn cup needle roller bearings, and heavy-duty needle roller bearings)**

	Shaft		Housing bore	
	Raceway surface	Fitting surface	Raceway surface	Fitting surface
Roundness	· Shaft diameter $\leq$ 25 mm : 2.5 $\mu$ m or less · Shaft diameter > 25 mm : 2.5 $\mu$ m $\times$ (shaft diameter /25 mm) or less	One-half the shaft diameter tolerance or less	8 $\mu$ m or one-half the bore tolerance or less	One-half the bore tolerance or less
Variation of mean diameter (Cylindricity)	Within the range of the bearing width, 5 $\mu$ m or less per 25 mm or one-half the bearing tolerance or less (whichever is smaller)	One-half the shaft diameter tolerance or less	Within the range of the bearing width, 5 $\mu$ m or less per 25 mm or one-half the bearing tolerance or less (whichever is smaller)	Within the length of the outer ring, 13 $\mu$ m or one-half the diameter tolerance (whichever is smaller) or less
Surface roughness	0.2 a or less	0.8 a or less	0.2 a or less	1.6 a or less
Hardness	58 HRC or harder <sup>1)</sup>	—	58 HRC or harder <sup>1)</sup>	—
Shaft slope	13 $\mu$ m or less per 25 mm		—	

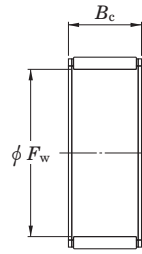
[Note] 1) During the carburizing or induction-hardening of case hardened steel, not only must the surface hardness requirement specified above be met, but the case depth of HV 550 (52.3 HRC) must be met in the range of 0.08  $D_w$  to 0.10  $D_w$  mm. ( $D_w$  : roller diameter)

**Table 26 Needle roller thrust bearing mounting surface specifications**

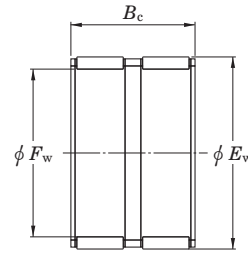
Flatness (dishing or coning)		Maximum angle : Arctan 0.001
Squareness		Maximum angle : Arctan 0.0005
Roughness (Ra)		0.2 a or less
Hardness		58 HRC or harder (refer to the note for Table 25 above regarding depth.)

**Radial needle roller and cage assemblies**  
**single-row, double-row assemblies**  
**metric series**  
**K, K ZW series**

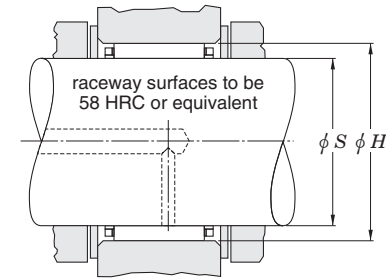
Shaft dia. 3 ~ (10) mm



K



K ZW

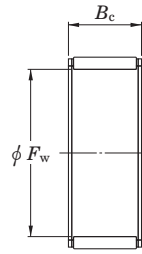


Boundary dimensions (mm)				Bearing No.	Basic load ratings (kN)		Fatigue load limit (kN) C <sub>u</sub>	Cage material <sup>1)</sup> P / S	Limiting speeds (min <sup>-1</sup> )		(Refer.) Mass (kg)	Recommended dimensions (mm)			
Shaft dia.	F <sub>w</sub>	E <sub>w</sub>	B <sub>c</sub> -0.20 -0.55		C <sub>r</sub>	C <sub>0r</sub>			Grease lub.	Oil lub.		S (Shaft)		H (Housing)	
												max.	min.	max.	min.
3	3	5	7	K3X5X7TN	1.56	1.29	0.200	P	48 000	74 000	0.0002	3.000	2.996	5.004	5.012
4	4	7	7	K4X7X7TN	1.83	1.32	0.200	P	34 000	52 000	0.0005	4.000	3.995	7.014	7.005
5	5	8	8	K5X8X8TN	2.18	1.71	0.260	P	31 000	47 000	0.0007	5.000	4.995	8.014	8.005
	5	8	10	K5X8X10TN	3.04	2.63	0.400	P	31 000	47 000	0.0008	5.000	4.995	8.014	8.005
	5	9	13	K5X9X13TN	4.29	3.55	0.540	P	26 000	40 000	0.002	5.000	4.995	9.014	9.005
6	6	9	8	K6X9X8H	3.19	2.90	0.420	S	29 000	44 000	0.0008	6.000	5.995	9.014	9.005
	6	9	8	K6X9X8TN	2.47	2.07	0.310	P	29 000	44 000	0.001	6.000	5.995	9.014	9.005
	6	9	10	K6X9X10TN	3.07	2.74	0.420	P	29 000	44 000	0.001	6.000	5.995	9.014	9.005
7	7	10	8	K7X10X8TN	2.74	2.44	0.370	P	28 000	42 000	0.001	7.000	6.994	10.014	10.005
	7	10	10	K7X10X10TN	3.40	3.22	0.490	P	28 000	42 000	0.001	7.000	6.994	10.014	10.005
	7	11	15	K7X11X15TN	6.44	6.24	0.940	P	23 000	35 000	0.003	7.000	6.994	11.017	11.006
8	8	11	8	K8X11X8FV	3.23	3.11	0.470	S	26 000	41 000	0.002	8.000	7.994	11.017	11.006
	8	11	8	K8X11X8TN	2.34	2.05	0.300	P	26 000	41 000	0.001	8.000	7.994	11.017	11.006
	8	11	10	K8X11X10H	4.57	4.89	0.740	S	26 000	41 000	0.002	8.000	7.994	11.017	11.006
	8	11	10	K8X11X10FV	4.01	4.11	0.630	S	26 000	41 000	0.002	8.000	7.994	11.017	11.006
	8	11	10	K8x11x10TN	3.84	3.91	0.600	P	26 000	41 000	0.001	8.000	7.994	11.006	11.017
	8	11	13	K8x11x13TN	5.18	5.75	0.870	P	26 000	41 000	0.002	8.000	7.994	11.006	11.017
	8	11	13	K8X11X13H	5.22	5.78	0.880	S	26 000	41 000	0.003	8.000	7.994	11.017	11.006
9	9	12	10	K9X12X10FH	4.27	4.60	0.700	S	26 000	40 000	0.003	9.000	8.994	12.017	12.006
	9	12	10	K9X12X10FV	4.27	4.60	0.700	S	26 000	40 000	0.002	9.000	8.994	12.017	12.006
	9	12	13	K9X12X13FH	5.57	6.47	0.980	S	26 000	40 000	0.003	9.000	8.994	12.017	12.006
	9	12	13	K9X12X13FV	5.57	6.47	0.980	S	26 000	40 000	0.003	9.000	8.994	12.017	12.006
	9	13	8	K9X13X8H	3.96	3.50	0.530	S	21 000	32 000	0.003	9.000	8.994	13.017	13.006
10	10	13	10	K10X13X10H	5.40	6.43	0.980	S	25 000	39 000	0.002	10.000	9.994	13.017	13.006
	10	13	10	K10X13X10TN	4.29	4.77	0.730	P	25 000	39 000	0.002	10.000	9.994	13.017	13.006
	10	13	13	K10X13X13	5.90	7.16	1.10	S	25 000	39 000	0.003	10.000	9.994	13.017	13.006

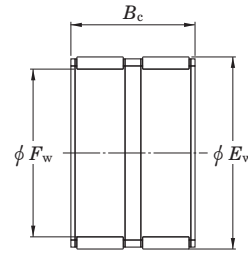
[Note] 1) Cage material: P: polymer cage, S: steel cage

**Radial needle roller and cage assemblies**  
**single-row, double-row assemblies**  
**metric series**  
**K, K ZW series**

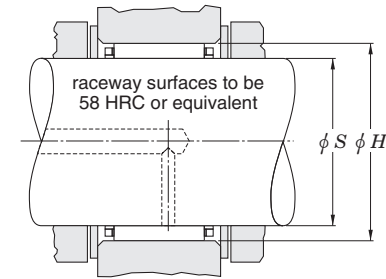
Shaft dia. (10) ~ (15) mm



K



K ZW

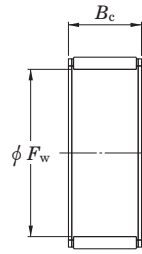


Shaft dia.	Boundary dimensions (mm)			Bearing No.	Basic load ratings (kN)		Fatigue load limit (kN) C <sub>u</sub>	Cage material <sup>1)</sup> P / S	Limiting speeds (min <sup>-1</sup> )		(Refer.) Mass (kg)	Recommended dimensions (mm)			
	F <sub>w</sub>	E <sub>w</sub>	B <sub>c</sub> -0.20 -0.55		C <sub>r</sub>	C <sub>0r</sub>			Grease lub.	Oil lub.		S (Shaft)		H (Housing)	
												max.	min.	max.	min.
10	10	13	16	K10X13X16	7.43	9.64	1.50	S	25 000	39 000	0.004	10.000	9.994	13.017	13.006
	10	14	10	K10X14X10H	6.12	6.29	0.960	S	20 000	31 000	0.003	10.000	9.994	14.017	14.006
	10	14	13	K10X14X13H	7.88	8.71	1.35	S	20 000	31 000	0.004	10.000	9.994	14.017	14.006
	10	16	12	K10X16X12F	8.39	7.47	1.15	S	15 000	24 000	0.006	10.000	9.994	16.017	16.006
	10	16	12	K10X16X12TN	7.50	6.40	0.970	P	15 000	24 000	0.005	10.000	9.994	16.017	16.006
12	12	15	10	K12X15X10H	5.85	7.51	1.15	S	24 000	37 000	0.003	12.000	11.992	15.017	15.006
	12	15	13	K12X15X13H	6.78	9.03	1.40	S	24 000	37 000	0.004	12.000	11.992	15.017	15.006
	12	16	13	K12X16X13H	7.49	8.51	1.60	S	19 000	30 000	0.006	12.000	11.992	16.017	16.006
	12	17	13	K12X17X13	8.93	9.29	1.20	S	16 000	25 000	0.008	12.000	11.992	17.017	17.006
	12	18	12	K12X18X12H	9.76	9.40	1.40	S	14 000	22 000	0.009	12.000	11.992	18.017	18.006
13	13	17	10	K13X17X10	7.22	8.33	1.25	S	19 000	29 000	0.004	13.000	12.992	17.017	17.006
	13	18	15	K13X18X15F	10.8	12.1	1.85	S	16 000	25 000	0.008	13.000	12.992	18.017	18.006
14	14	18	8	K14X18X8	5.39	5.82	0.880	S	19 000	29 000	0.004	14.000	13.992	18.017	18.006
	14	18	10	K14X18X10	7.17	8.41	1.30	S	19 000	29 000	0.005	14.000	13.992	18.017	18.006
	14	18	13	K14X18X13	9.73	12.5	1.90	S	19 000	29 000	0.006	14.000	13.992	18.017	18.006
	14	18	15	K14X18X15	10.5	13.8	2.15	S	19 000	29 000	0.007	14.000	13.992	18.017	18.006
	14	18	17	K14X18X17H	12.4	17.1	2.65	S	19 000	29 000	0.008	14.000	13.992	18.017	18.006
	14	19	13	K14X19X13H	10.2	11.4	1.75	S	16 000	24 000	0.008	14.000	13.992	19.020	19.007
	14	19	18	K14X19X18F	13.2	16.0	2.50	S	16 000	24 000	0.011	14.000	13.992	19.020	19.007
	14	20	12	K14X20X12	10.5	10.6	1.60	S	14 000	21 000	0.009	14.000	13.992	20.020	20.007
15	15	18	14	K15X18X14TN	7.92	11.9	1.80	P	13 000	23 000	0.003	15.000	14.992	18.017	18.006
	15	18	16	K15X18X16F	8.36	12.6	1.95	S	13 000	23 000	0.005	15.000	14.992	18.017	18.006
	15	18	17	K15X18X17	8.08	12.1	1.85	S	23 000	36 000	0.005	15.000	14.992	18.017	18.006
	15	19	10	K15X19X10	7.87	9.69	1.45	S	18 000	28 000	0.005	15.000	14.992	19.020	19.007
	15	19	13	K15X19X13	9.66	12.6	1.90	S	18 000	28 000	0.007	15.000	14.992	19.020	19.007
	15	19	17	K15X19X17H	12.3	17.2	2.65	S	18 000	28 000	0.009	15.000	14.992	19.020	19.007
	15	19	22	K15X19X22ZW	12.2	17.0	2.60	S	18 000	28 000	0.010	15.000	14.992	19.020	19.007

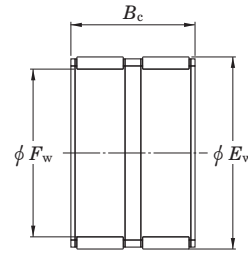
[Note] 1) Cage material: P: polymer cage, S: steel cage

**Radial needle roller and cage assemblies**  
**single-row, double-row assemblies**  
**metric series**  
**K, K ZW series**

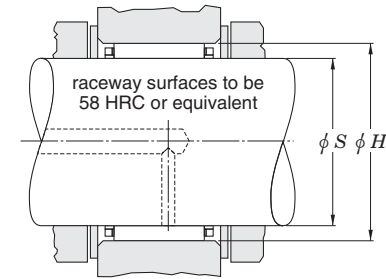
Shaft dia. (15) ~ (18) mm



K



K ZW

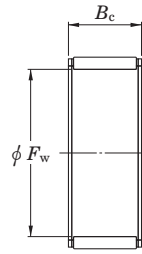


Shaft dia.	Boundary dimensions (mm)			Bearing No.	Basic load ratings (kN)		Fatigue load limit (kN) C <sub>u</sub>	Cage material <sup>1)</sup> P / S	Limiting speeds (min <sup>-1</sup> )		(Refer.) Mass (kg)	Recommended dimensions (mm)			
	F <sub>w</sub>	E <sub>w</sub>	B <sub>c</sub> -0.20 -0.55		C <sub>r</sub>	C <sub>0r</sub>			Grease lub.	Oil lub.		S (Shaft)		H (Housing)	
												max.	min.	max.	min.
15	15	20	13	K15X20X13H	9.93	11.3	1.80	S	16 000	24 000	0.008	15.000	14.992	20.020	20.007
	15	21	15	K15X21X15	13.4	14.8	2.30	S	14 000	21 000	0.013	15.000	14.992	21.020	21.007
	15	21	21	K15X21X21H	18.0	21.7	3.40	S	14 000	21 000	0.018	15.000	14.992	21.020	21.007
16	16	20	8	K16X20X8F	6.37	7.51	1.15	S	18 000	28 000	0.005	16.000	15.992	20.020	20.007
	16	20	10	K16X20X10H	7.82	9.76	1.50	S	18 000	28 000	0.006	16.000	15.992	20.020	20.007
	16	20	13	K16X20X13	10.1	13.5	2.05	S	18 000	28 000	0.007	16.000	15.992	20.020	20.007
	16	20	14	K16X20X14	10.8	14.8	2.25	S	18 000	28 000	0.007	16.000	15.992	20.020	20.007
	16	20	17	K16X20X17H	12.9	18.5	2.85	S	18 000	28 000	0.008	16.000	15.992	20.020	20.007
	16	20	20	K16X20X20	13.4	19.5	3.05	S	18 000	28 000	0.011	16.000	15.992	20.020	20.007
	16	22	12	K16X22X12	11.2	11.9	1.80	S	19 000	29 000	0.010	16.000	15.992	22.020	22.007
	16	22	16	K16X22X16H	14.9	17.2	2.70	S	19 000	29 000	0.014	16.000	15.992	22.020	22.007
	16	22	20	K16X22X20	18.6	22.9	3.60	S	19 000	29 000	0.017	16.000	15.992	22.020	22.007
17	16	24	20	K16X24X20	20.2	21.4	3.45	S	20 000	30 000	0.025	16.000	15.992	24.020	24.007
	17	20	10	K17X20X10	5.96	8.53	1.30	S	16 000	25 000	0.004	17.000	16.992	20.020	20.007
	17	21	10	K17X21X10	8.12	10.4	1.60	S	17 000	26 000	0.006	17.000	16.992	21.020	21.007
	17	21	12.8	K17X21X13H	10.5	14.5	2.20	S	17 000	26 000	0.008	17.000	16.992	21.020	21.007
	17	21	15	K17X21X15	11.4	16.1	2.50	S	17 000	26 000	0.008	17.000	16.992	21.020	21.007
	17	21	17	K17X21X17H	13.4	19.8	3.05	S	17 000	26 000	0.011	17.000	16.992	21.020	21.007
	17	22	20	K17X22X20FH	17.0	23.3	3.65	S	17 000	27 000	0.015	17.000	16.992	22.020	22.007
	17	23	15	K17X23X15F	14.1	16.3	2.55	S	18 000	27 000	0.010	17.000	16.992	23.020	23.007
18	18	22	8	K18X22X8F	6.32	7.70	1.15	S	16 000	24 000	0.005	18.000	17.992	22.020	22.007
	18	22	10	K18X22X10H	8.41	11.1	1.70	S	16 000	24 000	0.006	18.000	17.992	22.020	22.007
	18	22	13	K18X22X13H	10.8	15.4	2.35	S	16 000	24 000	0.008	18.000	17.992	22.020	22.007
	18	22	14	K18X22X14	11.6	16.8	2.55	S	16 000	24 000	0.009	18.000	17.992	22.020	22.007
	18	22	14	K18X22X14FV	11.3	16.3	2.45	S	16 000	24 000	0.009	18.000	17.992	22.020	22.007
	18	22	17	K18X22X17H	13.3	19.9	3.10	S	16 000	24 000	0.009	18.000	17.992	22.020	22.007
	18	22	20	K18X22X20F	15.0	23.4	3.65	S	16 000	24 000	0.011	18.000	17.992	22.020	22.007
	18	24	12	K18X24X12	11.8	13.1	1.95	S	17 000	25 000	0.011	18.000	17.992	24.020	24.007

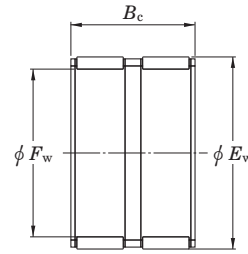
[Note] 1) Cage material: P: polymer cage, S: steel cage

**Radial needle roller and cage assemblies**  
**single-row, double-row assemblies**  
**metric series**  
**K, K ZW series**

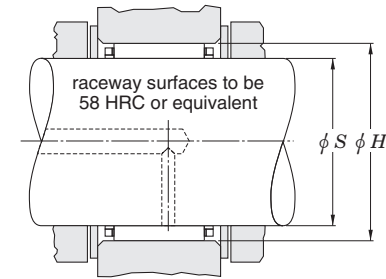
Shaft dia. (18) ~ (22) mm



K



K ZW

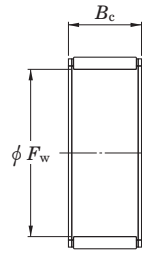


Shaft dia.	Boundary dimensions (mm)			Bearing No.	Basic load ratings (kN)		Fatigue load limit (kN) C <sub>u</sub>	Cage material <sup>1)</sup> P / S	Limiting speeds (min <sup>-1</sup> )		(Refer.) Mass (kg)	Recommended dimensions (mm)			
	F <sub>w</sub>	E <sub>w</sub>	B <sub>c</sub>		C <sub>r</sub>	C <sub>0r</sub>			Grease lub.	Oil lub.		S (Shaft)		H (Housing)	
			-0.20 -0.55									max.	min.	max.	min.
18	18	24	20	K18X24X20H	19.4	24.9	3.90	S	16 000	25 000	0.019	18.000	17.992	24.020	24.007
	18	25	22	K18X25X22H	23.3	28.6	4.50	S	17 000	26 000	0.025	18.000	17.992	25.020	25.007
	18	26	12	K18X26X12FV	13.8	13.5	2.10	S	11 000	17 000	0.020	18.000	17.992	26.020	26.007
	18	26	20	K18X26X20F	21.7	24.1	3.85	S	17 000	26 000	0.027	18.000	17.992	26.020	26.007
19	19	23	13	K19X23X13	10.8	15.5	2.35	S	15 000	23 000	0.008	19.000	18.991	23.020	23.007
	19	23	17	K19X23X17	13.4	20.6	3.20	S	15 000	23 000	0.011	19.000	18.991	23.020	23.007
20	20	24	8	K20X24X8F	7.31	9.60	1.50	S	14 000	22 000	0.005	20.000	19.991	24.020	24.007
	20	24	10	K20X24X10H	8.97	12.5	2.05	S	14 000	22 000	0.006	20.000	19.991	24.020	24.007
	20	24	12	K20X24X12	10.7	15.7	2.40	S	14 000	22 000	0.008	20.000	19.991	24.020	24.007
	20	24	13	K20X24X13H	11.5	17.3	1.30	S	14 000	22 000	0.009	20.000	19.991	24.020	24.007
	20	24	14	K20X24X14	12.4	18.9	2.85	S	14 000	22 000	0.009	20.000	19.991	24.020	24.007
	20	24	17	K20X24X17H	14.8	23.7	3.65	S	14 000	22 000	0.011	20.000	19.991	24.020	24.007
	20	26	12	K20X26X12	13.0	15.3	2.30	S	15 000	23 000	0.012	20.000	19.991	26.020	26.007
	20	26	13	K20X26X13H	13.4	15.9	2.35	S	15 000	23 000	0.014	20.000	19.991	26.020	26.007
	20	26	17	K20X26X17H	19.3	25.5	4.00	S	15 000	23 000	0.017	20.000	19.991	26.020	26.007
	20	26	20	K20X26X20	20.3	27.2	4.25	S	15 000	23 000	0.020	20.000	19.991	26.020	26.007
	20	28	20	K20X28X20H	24.6	29.0	2.70	S	15 000	23 000	0.028	20.000	19.991	28.020	28.007
	20	28	25	K20X28X25H	29.7	37.0	5.80	S	15 000	23 000	0.036	20.000	19.991	28.020	28.007
	20	30	30	K20X30X30H	38.9	45.8	7.20	S	16 000	24 000	0.055	20.000	19.991	30.020	30.007
	20	32	36	K20X32X36H	49.9	57.0	9.15	S	16 000	25 000	0.082	20.000	19.991	32.025	32.009
21	21	25	17	K21X25X17H	14.3	23.1	3.60	S	14 000	21 000	0.013	21.000	20.991	25.020	25.007
22	22	26	10	K22X26X10H	9.81	14.5	2.20	S	13 000	20 000	0.007	22.000	21.991	26.020	26.007
	22	26	13	K22X26X13H	11.8	18.3	2.95	S	13 000	20 000	0.012	22.000	21.991	26.020	26.007
	22	26	17	K22X26X17H	15.6	26.3	4.05	S	13 000	20 000	0.012	22.000	21.991	26.020	26.007
	22	26	18	K22X26X18H	15.3	25.5	4.00	S	13 000	20 000	0.017	22.000	21.991	26.020	26.007
	22	28	13	K22X28X13	13.9	17.1	2.60	S	13 000	20 000	0.015	22.000	21.991	28.020	28.007
	22	28	17	K22X28X17H	18.2	24.2	3.80	S	13 000	20 000	0.020	22.000	21.991	28.020	28.007

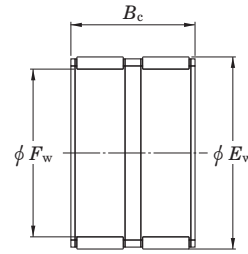
[Note] 1) Cage material: P: polymer cage, S: steel cage

**Radial needle roller and cage assemblies**  
**single-row, double-row assemblies**  
**metric series**  
**K, K ZW series**

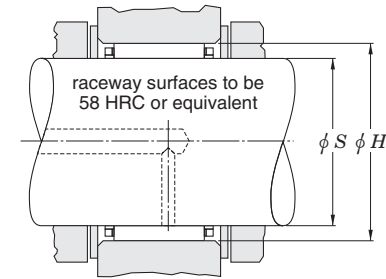
Shaft dia. (22) ~ (25) mm



K



K ZW

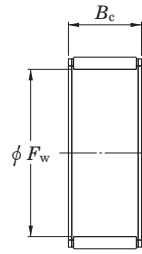


Shaft dia.	Boundary dimensions (mm)			Bearing No.	Basic load ratings (kN)		Fatigue load limit (kN) C <sub>u</sub>	Cage material <sup>1)</sup> P / S	Limiting speeds (min <sup>-1</sup> )		(Refer.) Mass (kg)	Recommended dimensions (mm)			
	F <sub>w</sub>	E <sub>w</sub>	B <sub>c</sub> -0.20 -0.55		C <sub>r</sub>	C <sub>0r</sub>			Grease lub.	Oil lub.		S (Shaft)		H (Housing)	
												max.	min.	max.	min.
22	22	30	15	K22X30X15H	19.7	22.3	3.45	S	14 000	21 000	0.023	22.000	21.991	30.020	30.007
	22	30	20	K22X30X20FV	24.4	29.4	4.70	S	14 000	21 000	0.031	22.000	21.991	30.020	30.007
	22	32	24	K22X32X24F	33.1	37.9	6.05	S	14 000	22 000	0.046	22.000	21.991	32.025	32.009
	22	32	30	K22X32X30H	41.8	51.3	8.05	S	14 000	22 000	0.057	22.000	21.991	32.025	32.009
23	23	28	24	K23X28X24F	22.4	36.2	5.70	S	12 000	19 000	0.023	23.000	22.991	28.020	28.007
	23	35	16	K23X35X16H	25.9	25.1	3.90	S	14 000	21 000	0.040	23.000	22.991	35.025	35.009
24	24	28	10	K24X28X10H	9.67	14.6	2.20	S	12 000	18 000	0.027	24.000	23.991	28.020	28.007
	24	28	13	K24X28X13H	12.5	20.2	3.05	S	12 000	18 000	0.010	24.000	23.991	28.020	28.007
	24	28	16	K24X28X16F	12.6	20.4	3.10	S	12 000	18 000	0.012	24.000	23.991	28.020	28.007
	24	28	17	K24X28X17H	15.4	26.4	4.10	S	12 000	18 000	0.013	24.000	23.991	28.020	28.007
	24	30	10	K24X30X10TN	11.3	13.5	2.05	P	12 000	19 000	0.008	24.000	23.991	30.020	30.007
	24	30	17	K24X30X17H	19.8	27.7	4.35	S	12 000	19 000	0.020	24.000	23.991	30.020	30.007
	24	30	22	K24X30X22	25.0	37.3	5.80	S	12 000	19 000	0.024	24.000	23.991	30.020	30.007
	24	36	23	K24X36X23H	37.1	40.1	6.40	S	13 000	20 000	0.070	24.000	23.991	36.025	36.009
25	25	29	10	K25X29X10H	9.61	14.6	2.25	S	11 000	17 000	0.008	25.000	24.991	29.020	29.007
	25	29	13	K25X29X13H	12.8	21.1	3.20	S	11 000	17 000	0.010	25.000	24.991	29.020	29.007
	25	29	17	K25X29X17H	15.1	26.2	4.10	S	11 000	17 000	0.016	25.000	24.991	29.020	29.007
	25	30	13	K25X30X13	14.6	21.4	3.25	S	11 000	17 000	0.012	25.000	24.991	30.020	30.007
	25	30	17	K25X30X17H	18.8	29.8	4.60	S	11 000	17 000	0.016	25.000	24.991	30.020	30.007
	25	30	18	K25X30X18	20.6	33.4	5.30	S	11 000	17 000	0.017	25.000	24.991	30.020	30.007
	25	30	20	K25X30X20H	21.9	36.1	5.65	S	11 000	17 000	0.019	25.000	24.991	30.020	30.007
	25	30	24	K25X30X24H	24.8	42.4	6.60	S	11 000	17 000	0.024	25.000	24.991	30.020	30.007
	25	30	26	K25X30X26ZW	23.0	38.6	5.90	S	11 000	17 000	0.027	25.000	24.991	30.020	30.007
	25	31	14	K25X31X14H	16.8	22.7	3.45	S	12 000	18 000	0.017	25.000	24.991	31.025	31.009
	25	31	17	K25X31X17H	19.7	27.8	4.35	S	12 000	18 000	0.020	25.000	24.991	31.025	31.009
	25	31	21	K25X31X21H	25.1	38.0	5.95	S	12 000	18 000	0.026	25.000	24.991	31.025	31.009
	25	31	24	K25X31X24FH	25.3	38.5	6.05	S	12 000	18 000	0.031	25.000	24.991	31.025	31.009
	25	32	16	K25X32X16	19.8	25.3	4.00	S	12 000	18 000	0.027	25.000	24.991	32.025	32.009

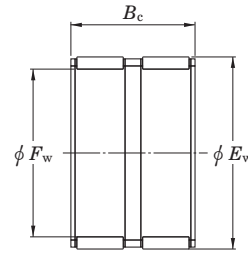
[Note] 1) Cage material: P: polymer cage, S: steel cage

**Radial needle roller and cage assemblies**  
**single-row, double-row assemblies**  
**metric series**  
**K, K ZW series**

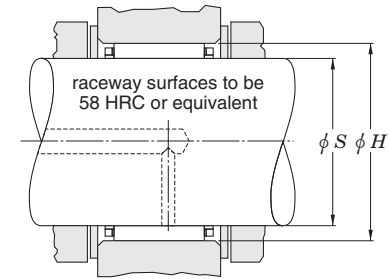
Shaft dia. (25) ~ 29 mm



K



K ZW



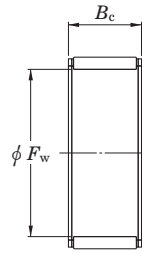
Shaft dia.	Boundary dimensions (mm)			Bearing No.	Basic load ratings (kN)		Fatigue load limit (kN) C <sub>u</sub>	Cage material <sup>1)</sup> P / S	Limiting speeds (min <sup>-1</sup> )		(Refer.) Mass (kg)	Recommended dimensions (mm)			
	F <sub>w</sub>	E <sub>w</sub>	B <sub>c</sub> -0.20 -0.55		C <sub>r</sub>	C <sub>0r</sub>			Grease lub.	Oil lub.		S (Shaft)		H (Housing)	
												max.	min.	max.	min.
25	25	33	20	K25X33X20H	28.8	37.6	5.95	S	12 000	18 000	0.035	25.000	24.991	33.025	33.009
	25	33	24	K25X33X24H	32.3	43.5	6.85	S	12 000	18 000	0.038	25.000	24.991	33.025	33.009
	25	33	25	K25X33X25H	33.0	44.6	7.00	S	12 000	18 000	0.041	25.000	24.991	33.025	33.009
	25	35	23.7	K25X35X23,7H	35.9	42.3	6.90	S	12 000	19 000	0.050	25.000	24.991	35.025	35.009
	25	35	25	K25X35X25H	37.8	46.2	7.25	S	12 000	19 000	0.054	25.000	24.991	35.025	35.009
	25	35	30	K25X35X30H	44.6	57.2	9.00	S	12 000	19 000	0.060	25.000	24.991	35.025	35.009
	25	35	36	K25X35X36H	52.4	70.4	11.0	S	12 000	19 000	0.074	25.000	24.991	35.025	35.009
	25	37	20	K25X37X20H	32.5	34.1	5.45	S	12 000	19 000	0.055	25.000	24.991	37.025	37.009
26	26	30	10	K26X30X10F	9.46	14.5	2.20	S	11 000	16 000	0.007	26.000	25.991	30.020	30.007
	26	30	13	K26X30X13	12.3	20.4	3.10	S	10 000	16 000	0.011	26.000	25.991	30.020	30.007
	26	30	17	K26X30X17	15.0	26.3	3.10	S	10 000	16 000	0.014	26.000	25.991	30.020	30.007
	26	30	22	K26X30X22ZW	16.7	30.2	4.60	S	10 000	16 000	0.018	26.000	25.991	30.020	30.007
28	28	32	21	K28X32X21F	18.7	35.7	5.55	S	9 900	15 000	0.018	28.000	27.991	32.025	32.009
	28	33	13	K28X33X13F	14.1	21.4	3.25	S	10 000	15 000	0.015	28.000	27.991	33.025	33.009
	28	33	17	K28X33X17H	19.8	33.0	5.10	S	10 000	15 000	0.018	28.000	27.991	33.025	33.009
	28	33	27	K28X33X27	29.0	53.8	8.30	S	10 000	15 000	0.027	28.000	27.991	33.025	33.009
	28	34	17	K28X34X17	21.1	31.5	6.30	S	10 000	16 000	0.022	28.000	27.991	34.025	34.009
	28	34	20	K28X34X20H	24.4	37.8	7.65	S	10 000	16 000	0.025	28.000	27.991	34.025	34.009
	28	35	15	K28X35X15H	19.5	25.6	3.95	S	10 000	16 000	0.025	28.000	27.991	35.025	35.009
	28	35	16	K28X35X16H	21.5	29.1	4.60	S	10 000	16 000	0.026	28.000	27.991	35.025	35.009
	28	35	27	K28X35X27H	35.2	54.7	8.50	S	10 000	16 000	0.042	28.000	27.991	35.025	35.009
	28	36	20	K28X36X20FV	27.8	37.0	5.95	S	10 000	16 000	0.039	28.000	27.991	36.025	36.009
	28	38	25	K28X38X25,5	40.9	52.7	8.25	S	11 000	16 000	0.059	28.000	27.991	38.025	38.009
	28	40	18	K28X40X18H	33.6	36.5	5.90	S	11 000	17 000	0.060	28.000	27.991	40.025	40.009
	28	40	25	K28X40X25H	45.5	54.0	8.55	S	11 000	17 000	0.072	28.000	27.991	40.025	40.009
	28	40	30	K28X40X30H	54.3	67.8	10.7	S	11 000	17 000	0.100	28.000	27.991	40.025	40.009
28	41	25	K28X41X25H	49.2	57.1	9.05	S	11 000	17 000	0.082	28.000	27.991	41.025	41.009	
29	29	34	27	K29X34X27F	28.9	54.0	8.40	S	9 700	15 000	0.033	29.000	28.991	34.025	34.009

[Note] 1) Cage material: P: polymer cage, S: steel cage

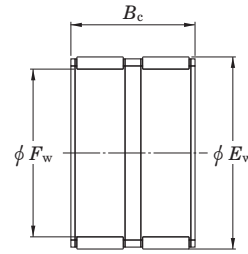


Radial needle roller and cage assemblies  
single-row, double-row assemblies  
metric series  
K, K ZW series

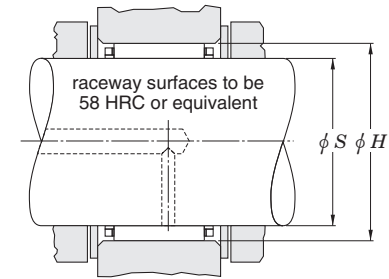
Shaft dia. 30 ~ (34) mm



K



K ZW

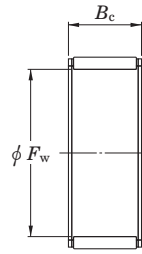


Shaft dia.	Boundary dimensions (mm)			Bearing No.	Basic load ratings (kN)		Fatigue load limit (kN) C <sub>u</sub>	Cage material <sup>1)</sup> P / S	Limiting speeds (min <sup>-1</sup> )		(Refer.) Mass (kg)	Recommended dimensions (mm)			
	F <sub>w</sub>	E <sub>w</sub>	B <sub>c</sub> -0.20 -0.55		C <sub>r</sub>	C <sub>0r</sub>			Grease lub.	Oil lub.		S (Shaft)		H (Housing)	
												max.	min.	max.	min.
30	30	34	13	K30X34X13	13.5	24.1	3.65	S	9 200	14 000	0.011	30.000	29.991	34.025	34.009
	30	35	13	K30X35X13H	15.6	24.9	3.80	S	9 300	14 000	0.017	30.000	29.991	35.025	35.009
	30	35	17	K30X35X17H	20.2	34.6	5.35	S	9 300	14 000	0.022	30.000	29.991	35.025	35.009
	30	35	20	K30X35X20H	23.5	41.9	6.55	S	9 300	14 000	0.023	30.000	29.991	35.025	35.009
	30	35	22.8	K30X35X23F	25.6	46.8	7.40	S	9 300	14 000	0.028	30.000	29.991	35.025	35.009
	30	35	27	K30X35X27H	30.6	59.0	9.10	S	9 300	14 000	0.032	30.000	29.991	35.025	35.009
	30	35	27	K30X35X27HZW	19.9	33.6	5.10	S	9 300	14 000	0.033	30.000	29.991	35.025	35.009
	30	36	14	K30X36X14	18.0	26.2	4.00	S	9 500	15 000	0.020	30.000	29.991	36.025	36.009
	30	37	17.8	K30X37X18	24.3	34.8	6.00	S	9 600	15 000	0.033	30.000	29.991	37.025	37.009
	30	40	30	K30X40X30H	49.2	67.8	10.6	S	9 900	15 000	0.077	30.000	29.991	40.025	40.009
	30	42	30	K30X42X30H	54.2	68.6	10.8	S	10 000	16 000	0.096	30.000	29.991	42.025	42.009
	30	44	26	K30X44X26H	52.4	59.9	9.55	S	10 000	16 000	0.095	30.000	29.991	44.025	44.009
32	32	36	15	K32X36X15F	11.6	20.2	3.10	S	8 600	13 000	0.015	32.000	31.989	36.025	36.009
	32	37	13	K32X37X13	15.2	24.4	4.00	S	8 700	13 000	0.018	32.000	31.989	37.025	37.009
	32	37	17	K32X37X17H	20.0	34.8	5.40	S	8 700	13 000	0.020	32.000	31.989	37.025	37.009
	32	37	27	K32X37X27	29.3	56.8	8.85	S	8 700	13 000	0.035	32.000	31.989	37.025	37.009
	32	38	20	K32X38X20H	27.3	45.7	7.15	S	8 800	14 000	0.030	32.000	31.989	38.025	38.009
	32	38	26	K32X38X26H	33.2	58.8	9.15	S	8 800	14 000	0.037	32.000	31.989	38.025	38.009
	32	39	16	K32X39X16H	23.0	33.0	5.20	S	8 900	14 000	0.030	32.000	31.989	39.025	39.009
	32	39	18	K32X39X18H	25.8	38.2	6.05	S	8 900	14 000	0.033	32.000	31.989	39.025	39.009
	32	40	25	K32X40X25H	37.9	57.2	8.90	S	9 000	14 000	0.052	32.000	31.989	40.025	40.009
	32	40	36	K32X40X36H	52.3	86.4	13.6	S	9 000	14 000	0.080	32.000	31.989	40.025	40.009
	32	42	42	K32X42X42H	69.2	108	17.1	S	9 200	14 000	0.110	32.000	31.989	42.025	42.009
	32	46	18	K32X46X18H	39.2	41.9	6.80	S	9 600	15 000	0.075	32.000	31.989	46.025	46.009
	32	46	32	K32X46X32H	67.0	83.4	13.1	S	9 600	15 000	0.140	32.000	31.989	46.025	46.009
	32	46	40	K32X46X40H	81.7	108	12.2	S	9 600	15 000	0.158	32.000	31.989	46.025	46.009
	33	33	51	23	K33X51X23H	55.9	57.6	9.35	S	9 600	15 000	0.140	33.000	32.989	51.029
34	34	38	11	K34X38X11	12.2	21.9	3.35	S	8 100	12 000	0.011	34.000	33.989	38.025	38.009

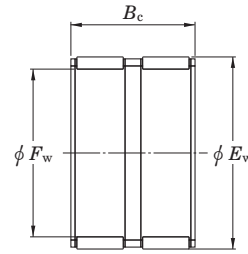
[Note] 1) Cage material: P: polymer cage, S: steel cage

**Radial needle roller and cage assemblies**  
**single-row, double-row assemblies**  
**metric series**  
**K, K ZW series**

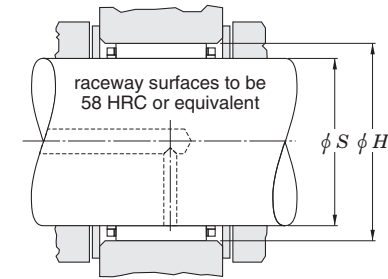
Shaft dia. (34) ~ (38) mm



K



K ZW

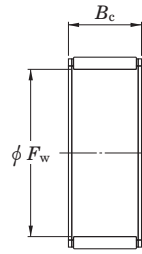


Shaft dia.	Boundary dimensions (mm)			Bearing No.	Basic load ratings (kN)		Fatigue load limit (kN) C <sub>u</sub>	Cage material <sup>1)</sup> P / S	Limiting speeds (min <sup>-1</sup> )		(Refer.) Mass (kg)	Recommended dimensions (mm)			
	F <sub>w</sub>	E <sub>w</sub>	B <sub>c</sub> -0.20 -0.55		C <sub>r</sub>	C <sub>0r</sub>			Grease lub.	Oil lub.		S (Shaft)		H (Housing)	
												max.	min.	max.	min.
34	34	44	26	<b>K34X44X26FH</b>	42.9	58.9	9.40	S	8 600	13 000	0.080	34.000	33.989	44.025	44.009
35	35	40	13	<b>K35X40X13H</b>	16.2	27.2	4.15	S	7 900	12 000	0.018	35.000	34.989	40.025	40.009
	35	40	17	<b>K35X40X17H</b>	22.1	40.8	6.35	S	7 900	12 000	0.025	35.000	34.989	40.025	40.009
	35	40	19	<b>K35X40X19H</b>	23.2	43.2	6.80	S	7 900	12 000	0.025	35.000	34.989	40.025	40.009
	35	40	25	<b>K35X40X25H</b>	28.4	56.2	8.70	S	7 900	12 000	0.035	35.000	34.989	40.025	40.009
	35	40	27	<b>K35X40X27H</b>	29.8	59.6	9.20	S	7 900	12 000	0.037	35.000	34.989	40.025	40.009
	35	42	16	<b>K35X42X16AH</b>	24.5	36.8	5.80	S	8 100	12 000	0.031	35.000	34.989	42.025	42.009
	35	42	18	<b>K35X42X18</b>	27.5	42.6	6.75	S	8 100	12 000	0.035	35.000	34.989	42.025	42.009
	35	42	20	<b>K35X42X20H</b>	30.4	48.5	7.65	S	8 100	12 000	0.037	35.000	34.989	42.025	42.009
	35	42	30	<b>K35X42X30FH</b>	40.5	70.0	10.9	S	8 100	12 000	0.061	35.000	34.989	42.025	42.009
	35	45	20	<b>K35X45X20FH</b>	36.5	49.9	8.00	S	8 400	13 000	0.059	35.000	34.989	45.025	45.009
	35	45	30	<b>K35X45X30F</b>	51.2	74.5	11.7	S	8 400	13 000	0.100	35.000	34.989	45.025	45.009
	35	45	35	<b>K35X45X35H</b>	62.1	95.5	15.0	S	8 400	13 000	0.085	35.000	34.989	45.025	45.009
	35	45	41	<b>K35X45X41</b>	70.8	113	17.7	S	8 400	13 000	0.120	35.000	34.989	45.025	45.009
	35	45	49	<b>K35X45X49H</b>	82.5	138	21.4	S	8 400	13 000	0.143	35.000	34.989	45.025	45.009
	35	45	49	<b>K35X45X49HZW</b>	71.8	115	18.1	S	8 400	13 000	0.143	35.000	34.989	45.025	45.009
	35	50	23	<b>K35X50X23H</b>	53.0	60.3	9.75	S	8 700	13 000	0.110	35.000	34.989	50.025	50.009
35	50	40	<b>K35X50X40F</b>	79.7	102	16.2	S	8 700	13 000	0.200	35.000	34.989	50.025	50.009	
36	36	40	29	<b>K36X40X29TN</b>	21.2	45.2	7.15	P	7 600	12 000	0.029	36.000	35.989	40.025	40.009
	36	42	16	<b>K36X42X16</b>	22.8	37.7	5.95	S	7 800	12 000	0.027	36.000	35.989	42.025	42.009
37	37	42	13	<b>K37X42X13H</b>	16.9	29.4	4.50	S	7 500	11 000	0.017	37.000	36.989	42.025	42.009
	37	42	17	<b>K37X42X17H</b>	21.9	41.0	6.35	S	7 500	11 000	0.025	37.000	36.989	42.025	42.009
	37	42	27	<b>K37X42X27F</b>	32.1	66.9	10.4	S	7 500	11 000	0.039	37.000	36.989	42.025	42.009
	37	44	19	<b>K37X44X19H</b>	29.7	48.0	7.65	S	7 600	12 000	0.039	37.000	36.989	44.025	44.009
38	38	41	9	<b>K38X41X9TN</b>	5.93	11.0	1.65	P	7 100	11 000	0.004	38.000	37.989	41.025	41.009
	38	43	17	<b>K38X43X17H</b>	21.8	41.0	6.35	S	7 300	11 000	0.032	38.000	37.989	43.025	43.009
	38	43	27	<b>K38X43X27</b>	31.9	67.0	10.4	S	7 300	11 000	0.041	38.000	37.989	43.025	43.009

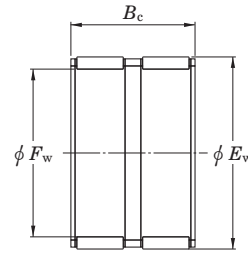
[Note] 1) Cage material: P: polymer cage, S: steel cage

**Radial needle roller and cage assemblies**  
**single-row, double-row assemblies**  
**metric series**  
**K, K ZW series**

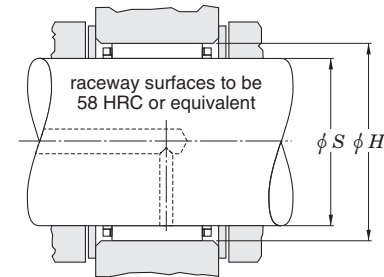
Shaft dia. (38) ~ 42 mm



K



K ZW

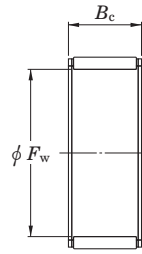


Shaft dia.	Boundary dimensions (mm)			Bearing No.	Basic load ratings (kN)		Fatigue load limit (kN) C <sub>u</sub>	Cage material <sup>1)</sup> P / S	Limiting speeds (min <sup>-1</sup> )		(Refer.) Mass (kg)	Recommended dimensions (mm)				
	F <sub>w</sub>	E <sub>w</sub>	B <sub>c</sub> -0.20 -0.55		C <sub>r</sub>	C <sub>0r</sub>			Grease lub.	Oil lub.		S (Shaft)		H (Housing)		
												max.	min.	max.	min.	
38	38	46	19.8	K38X46X20H	33.3	51.0	8.10	S	7 500	12 000	0.055	38.000	37.989	46.025	46.009	
	38	46	32	K38X46X32H	55.2	98.1	15.3	S	7 500	12 000	0.090	38.000	37.989	46.025	46.009	
	38	50	25	K38X50X25	53.0	70.8	11.2	S	7 800	12 000	0.100	38.000	37.989	50.025	50.009	
	38	50	33	K38X50X33H	68.3	98.2	15.4	S	7 800	12 000	0.126	38.000	37.989	50.025	50.009	
	38	50	40	K38X50X40FH	76.2	113	17.8	S	7 800	12 000	0.170	38.000	37.989	50.025	50.009	
	40	40	45	13	K40X45X13H	17.6	31.7	4.80	S	6 900	11 000	0.022	40.000	39.989	45.025	45.009
40		45	18	K40X45X18H	25.1	50.4	8.00	S	6 900	11 000	0.031	40.000	39.989	45.025	45.009	
40		45	21	K40X45X21H	23.3	45.2	8.50	S	6 900	11 000	0.033	40.000	39.989	45.025	45.009	
40		45	27	K40X45X27H	32.7	70.2	10.8	S	6 900	11 000	0.040	40.000	39.989	45.025	45.009	
40		45	27	K40X45X27TN	33.3	72.1	11.2	P	6 900	11 000	0.030	40.000	39.989	45.025	45.009	
40		45	29	K40X45X29H	34.7	75.9	11.7	S	6 900	11 000	0.050	40.000	39.989	45.025	45.009	
40		46	17	K40X46X17	25.2	44.0	6.95	S	7 000	11 000	0.033	40.000	39.989	46.025	46.009	
40		47	18	K40X47X18	28.0	45.6	7.25	S	7 000	11 000	0.041	40.000	39.989	47.025	47.009	
40		47	20	K40X47X20	31.1	52.1	8.25	S	7 000	11 000	0.042	40.000	39.989	47.025	47.009	
40		48	20	K40X48X20FV1	35.5	56.3	8.45	S	7 100	11 000	0.052	40.000	39.989	48.025	48.009	
40		48	20	K40X48X20H	35.5	56.3	8.95	S	7 100	11 000	0.050	40.000	39.989	48.025	48.009	
40		48	35	K40X48X35H	57.3	104	16.3	S	7 100	11 000	0.098	40.000	39.989	48.025	48.009	
40		50	27	K40X50X27H	53.0	81.0	12.7	S	7 200	11 000	0.084	40.000	39.989	50.025	50.009	
40		55	45	K40X55X45H	103	146	23.0	S	7 500	12 000	0.221	40.000	39.989	55.029	55.010	
40		56	26	K40X56X26H	63.7	75.7	12.0	S	7 600	12 000	0.138	40.000	39.989	56.029	56.010	
41		41	48	31	K41X48X31HZW	38.0	68.1	10.6	S	6 800	11 000	0.067	41.000	40.989	48.025	48.009
42		42	47	13	K42X47X13H	18.7	34.9	5.30	S	6 500	10 000	0.027	42.000	41.989	47.025	47.009
		42	47	17	K42X47X17H	22.8	45.2	7.30	S	6 500	10 000	0.028	42.000	41.989	47.025	47.009
	42	47	27	K42X47X27H	33.8	74.7	11.6	S	6 500	10 000	0.041	42.000	41.989	47.025	47.009	
	42	48	24	K42X48X24F	33.1	63.9	10.1	S	6 600	10 000	0.046	42.000	41.989	48.025	48.009	
	42	50	13	K42X50X13H	20.9	28.9	4.45	S	6 700	10 000	0.035	42.000	41.989	50.025	50.009	
	42	50	20	K42X50X20H	35.2	56.6	9.00	S	6 700	10 000	0.054	42.000	41.989	50.025	50.009	
	42	50	30	K42X50X30H	51.3	91.9	14.4	S	6 700	10 000	0.080	42.000	41.989	50.025	50.009	

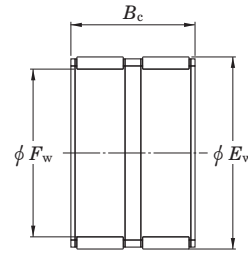
[Note] 1) Cage material: P: polymer cage, S: steel cage

**Radial needle roller and cage assemblies**  
**single-row, double-row assemblies**  
**metric series**  
**K, K ZW series**

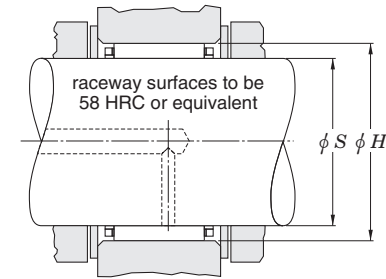
Shaft dia. 43 ~ (47) mm



K



K ZW

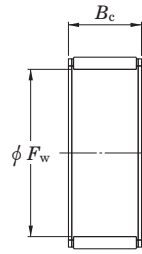


Shaft dia.	Boundary dimensions (mm)			Bearing No.	Basic load ratings (kN)		Fatigue load limit (kN) C <sub>u</sub>	Cage material <sup>1)</sup> P / S	Limiting speeds (min <sup>-1</sup> )		(Refer.) Mass (kg)	Recommended dimensions (mm)			
	F <sub>w</sub>	E <sub>w</sub>	B <sub>c</sub> -0.20 -0.55		C <sub>r</sub>	C <sub>0r</sub>			Grease lub.	Oil lub.		S (Shaft)		H (Housing)	
												max.	min.	max.	min.
43	43	48	17	K43X48X17FH	23.0	45.8	6.85	S	6 400	9 800	0.036	43.000	42.989	48.025	48.009
	43	48	27	K43X48X27H	34.8	78.0	12.1	S	6 400	9 800	0.050	43.000	42.989	48.025	48.009
44	44	50	22	K44X50X22H	31.6	60.6	9.45	S	6 400	9 900	0.046	44.000	43.989	50.025	50.009
	44	50	30	K44X50X30,5HZW	35.5	70.5	10.7	S	6 400	9 900	0.068	44.000	43.989	50.025	50.009
45	45	50	13	K45X50X13H	18.4	35.1	5.35	S	6 100	9 400	0.022	45.000	44.989	50.025	50.009
	45	50	15	K45X50X15H	19.4	37.3	5.75	S	6 100	9 400	0.028	45.000	44.989	50.025	50.009
	45	50	17	K45X50X17H	24.9	51.8	8.05	S	6 100	9 400	0.030	45.000	44.989	50.025	50.009
	45	50	20	K45X50X20F	27.0	57.4	9.00	S	6 100	9 400	0.040	45.000	44.989	50.025	50.009
	45	50	21	K45X50X21CH	24.6	50.4	7.85	S	6 100	9 400	0.036	45.000	44.989	50.025	50.009
	45	50	27	K45X50X27FH	34.2	77.4	12.0	S	6 100	9 400	0.043	45.000	44.989	50.025	50.009
	45	50	27	K45X50X27TN	31.8	70.7	11.0	P	6 100	9 400	0.048	45.000	44.989	50.025	50.009
	45	52	18	K45X52X18H	30.1	52.0	8.25	S	6 200	9 500	0.045	45.000	44.989	52.029	52.010
	45	52	21	K45X52X21F	35.0	63.2	9.90	S	6 200	9 500	0.055	45.000	44.989	52.029	52.010
	45	53	20	K45X53X20H	36.0	59.5	9.45	S	6 200	9 600	0.054	45.000	44.989	53.029	53.010
	45	53	24.8	K45X53X25H	45.9	81.5	12.7	S	6 200	9 600	0.072	45.000	44.989	53.029	53.010
	45	53	25	K45X53X25F	42.5	73.7	11.7	S	6 200	9 600	0.075	45.000	44.989	53.029	53.010
	45	53	28	K45X53X28H	49.3	89.2	13.9	S	6 200	9 600	0.078	45.000	44.989	53.029	53.010
	45	55	20	K45X55X20H	42.0	62.2	10.0	S	6 400	9 800	0.074	45.000	44.989	55.029	55.010
	45	59	18	K45X59X18H	47.8	58.9	9.60	S	6 600	10 000	0.107	45.000	44.989	59.029	59.010
	45	59	18	K45X59X18TN	45.7	55.4	9.00	P	6 600	10 000	0.097	45.000	44.989	59.029	59.010
	45	59	36	K45X59X36H	82.4	118	18.6	S	6 600	10 000	0.181	45.000	44.989	59.029	59.010
45	60	30	K45X60X30H	75.5	101	16.0	S	6 600	10 000	0.171	45.000	44.989	60.029	60.010	
45	60	45	K45X60X45H	108	160	25.2	S	6 600	10 000	0.280	45.000	44.989	60.029	60.010	
46	46	53	36	K46X53X36HZW	48.6	96.7	15.3	S	6 100	9 300	0.100	46.000	45.989	53.029	53.010
47	47	52	15	K47X52X15FH	20.1	39.8	6.15	S	5 800	8 900	0.030	47.000	46.989	52.029	52.010
	47	52	17	K47X52X17H	24.2	50.4	7.85	S	5 800	8 900	0.032	47.000	46.989	52.029	52.010
	47	52	27	K47X52X27H	36.6	85.9	13.3	S	5 800	8 900	0.045	47.000	46.989	52.029	52.010

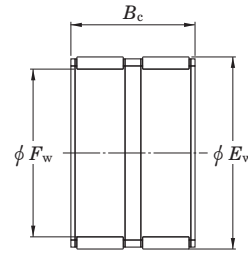
[Note] 1) Cage material: P: polymer cage, S: steel cage

**Radial needle roller and cage assemblies**  
**single-row, double-row assemblies**  
**metric series**  
**K, K ZW series**

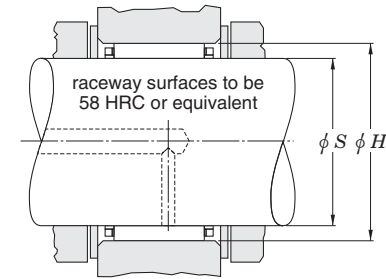
Shaft dia. (47) ~ (55) mm



K



K ZW

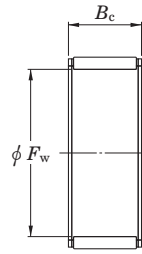


Shaft dia.	Boundary dimensions (mm)			Bearing No.	Basic load ratings (kN)		Fatigue load limit (kN) C <sub>u</sub>	Cage material <sup>1)</sup> P / S	Limiting speeds (min <sup>-1</sup> )		(Refer.) Mass (kg)	Recommended dimensions (mm)			
	F <sub>w</sub>	E <sub>w</sub>	B <sub>c</sub> -0.20 -0.55		C <sub>r</sub>	C <sub>0r</sub>			Grease lub.	Oil lub.		S (Shaft)		H (Housing)	
												max.	min.	max.	min.
47	47	55	28	K47X55X28FV1	48.9	89.5	14.0	S	6 000	9 200	0.092	47.000	46.989	55.029	55.010
48	48	53	17	K48X53X17H K48X54X19H	25.7	54.9	8.55 9.85	S	5 700	8 700	0.032 0.042	48.000	47.989	53.029	53.010
		48	54		19										
49	49	55	32	K49X55X32HZW K49X65X38H	40.2	86.4	13.4 22.7	S	5 600	8 600	0.080 0.244	49.000	48.989	55.029	55.010
		49	65		38										
50	50	55	17	K50X55X17H	25.5	55.0	8.55	S	5 400	8 400	0.032	50.000	49.989	55.029	55.010
	50	55	20	K50X55X20H	30.2	68.5	10.7	S	5 400	8 400	0.038	50.000	49.989	55.029	55.010
	50	55	30	K50X55X30	38.2	92.4	14.4	S	5 400	8 400	0.057	50.000	49.989	55.029	55.010
	50	55	30	K50X55X30FV1	38.2	92.4	14.4	S	5 400	8 400	0.057	50.000	49.989	55.029	55.010
	50	56	23	K50X56X23	35.5	74.1	11.7	S	5 500	8 500	0.051	50.000	49.989	56.029	56.010
	50	57	18	K50X57X18FH	31.3	56.4	8.95	S	5 500	8 500	0.050	50.000	49.989	57.029	57.010
	50	58	20	K50X58X20H	38.8	67.8	10.8	S	5 600	8 600	0.065	50.000	49.989	58.029	58.010
	50	58	25	K50X58X25H	46.5	85.6	13.4	S	5 600	8 600	0.081	50.000	49.989	58.029	58.010
	50	58	35	K50X58X35H	64.9	131	20.6	S	5 600	8 600	0.105	50.000	49.989	58.029	58.010
	50	62	30	K50X62X30H	64.6	98.1	15.5	S	5 800	8 900	0.136	50.000	49.989	62.029	62.010
	50	66	30	K50X66X30H	80.9	109	17.4	S	5 900	9 100	0.192	50.000	49.989	66.029	66.010
	50	70	32	K50X70X32H	103	129	20.6	S	6 100	9 300	0.224	50.000	49.989	70.029	70.010
52	52	57	12	K52X57X12	18.4	36.7	5.60	S	5 200	8 000	0.022	52.000	51.987	57.029	57.010
	52	57	17	K52X57X17H	21.4	44.3	6.90	S	5 200	8 000	0.035	52.000	51.987	57.029	57.010
	52	60	24	K52X60X24	47.1	88.3	13.9	S	5 400	8 200	0.078	52.000	51.987	60.029	60.010
55	55	60	17	K55X60X17	26.0	58.3	9.10	S	4 900	7 600	0.037	55.000	54.987	60.029	60.010
	55	60	20	K55X60X20H	30.7	72.4	11.3	S	4 900	7 600	0.042	55.000	54.987	60.029	60.010
	55	60	27	K55X60X27H	40.1	102	15.7	S	4 900	7 600	0.055	55.000	54.987	60.029	60.010
	55	60	30	K55X60X30FH	40.6	103	16.1	S	4 900	7 600	0.068	55.000	54.987	60.029	60.010
	55	61	26	K55X61X26H	44.3	102	15.9	S	5 000	7 600	0.063	55.000	54.987	61.029	61.010
	55	62	18	K55X62X18H	33.2	62.8	10.0	S	5 000	7 700	0.055	55.000	54.987	62.029	62.010
	55	63	15	K55X63X15F	30.5	51.5	8.00	S	5 000	7 800	0.054	55.000	54.987	63.029	63.010

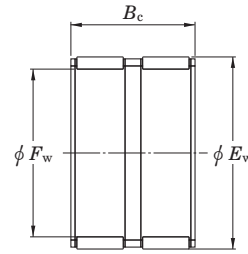
[Note] 1) Cage material: P: polymer cage, S: steel cage

**Radial needle roller and cage assemblies**  
**single-row, double-row assemblies**  
**metric series**  
**K, K ZW series**

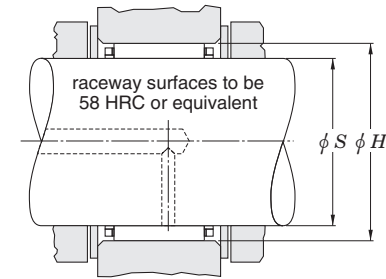
Shaft dia. (55) ~ 68 mm



K



K ZW

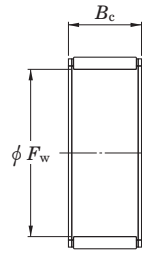


Shaft dia.	Boundary dimensions (mm)			Bearing No.	Basic load ratings (kN)		Fatigue load limit (kN) C <sub>u</sub>	Cage material <sup>1)</sup> P / S	Limiting speeds (min <sup>-1</sup> )		(Refer.) Mass (kg)	Recommended dimensions (mm)			
	F <sub>w</sub>	E <sub>w</sub>	B <sub>c</sub> -0.20 -0.55		C <sub>r</sub>	C <sub>0r</sub>			Grease lub.	Oil lub.		S (Shaft)		H (Housing)	
												max.	min.	max.	min.
55	55	63	20	<b>K55X63X20</b>	40.3	73.5	11.7	S	5 000	7 800	0.072	55.000	54.987	63.029	63.010
	55	63	25	<b>K55X63X25</b>	49.8	96.5	15.1	S	5 000	7 800	0.080	55.000	54.987	63.029	63.010
	55	63	32	<b>K55X63X32</b>	62.3	129	20.0	S	5 000	7 800	0.108	55.000	54.987	63.029	63.010
58	58	63	17	<b>K58X63X17F</b>	27.0	62.6	9.80	S	4 700	7 200	0.037	58.000	57.987	63.029	63.010
	58	64	19	<b>K58X64X19H</b>	32.9	70.6	11.3	S	4 700	7 200	0.037	58.000	57.987	64.029	64.010
	58	65	18	<b>K58X65X18H</b>	34.3	67.1	10.7	S	4 700	7 300	0.058	58.000	57.987	65.029	65.010
60	60	65	20	<b>K60X65X20H</b>	31.9	78.1	12.2	S	4 500	6 900	0.046	60.000	59.987	65.029	65.010
	60	65	26.8	<b>K60X65X27FH</b>	39.5	103	16.0	S	4 500	6 900	0.059	60.000	59.987	65.029	65.010
	60	65	29.8	<b>K60X65X30FH</b>	42.9	114	17.8	S	4 500	6 900	0.085	60.000	59.987	65.029	65.010
	60	65	30	<b>K60X65X30</b>	42.9	114	17.8	S	4 500	6 900	0.070	60.000	59.987	65.029	65.010
	60	68	17	<b>K60X68X17F</b>	34.2	61.4	9.50	S	4 600	7 100	0.066	60.000	59.987	68.029	68.010
	60	68	20	<b>K60X68X20H</b>	41.8	79.2	12.6	S	4 600	7 100	0.066	60.000	59.987	68.029	68.010
	60	68	23	<b>K60X68X23H</b>	49.0	97.2	15.4	S	4 600	7 100	0.089	60.000	59.987	68.029	68.010
	60	68	25	<b>K60X68X25</b>	51.6	104	16.3	S	4 600	7 100	0.091	60.000	59.987	68.029	68.010
	60	68	30	<b>K60X68X30ZW</b>	46.4	90.1	13.9	S	4 600	7 100	0.119	60.000	59.987	68.029	68.010
63	63	71	20	<b>K63X71X20</b>	41.4	79.4	12.7	S	4 400	6 700	0.070	63.000	62.987	71.029	71.010
64	64	70	16	<b>K64X70X16</b>	26.4	55.1	8.55	S	4 200	6 500	0.049	64.000	63.987	70.029	70.010
65	65	70	20	<b>K65X70X20CH</b>	28.6	69.2	10.8	S	4 100	6 400	0.050	65.000	64.987	70.029	70.010
	65	70	30	<b>K65X70X30</b>	44.4	123	19.1	S	4 100	6 400	0.075	65.000	64.987	70.029	70.010
	65	73	23	<b>K65X73X23H</b>	48.2	97.7	15.5	S	4 200	6 500	0.091	65.000	64.987	73.029	73.010
	65	73	30	<b>K65X73X30H</b>	60.1	129	20.3	S	4 200	6 500	0.116	65.000	64.987	73.029	73.010
68	68	74	20	<b>K68X74X20FH</b>	37.5	88.1	13.2	S	4 000	6 100	0.062	68.000	67.987	74.029	74.010
	68	74	28	<b>K68X74X28CH</b>	44.8	110	17.1	S	4 000	6 100	0.082	68.000	67.987	74.029	74.010
	68	74	30	<b>K68X74X30H</b>	47.6	119	18.5	S	4 000	6 100	0.098	68.000	67.987	74.029	74.010
	68	74	35	<b>K68X74X35HZW</b>	45.1	111	17.1	S	4 000	6 100	0.120	68.000	67.987	74.029	74.010
	68	76	20	<b>K68X76X20</b>	43.8	87.8	14.0	S	4 000	6 200	0.086	68.000	67.987	76.029	76.010

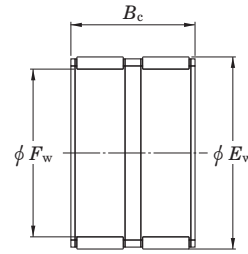
[Note] 1) Cage material: P: polymer cage, S: steel cage

**Radial needle roller and cage assemblies**  
**single-row, double-row assemblies**  
**metric series**  
**K, K ZW series**

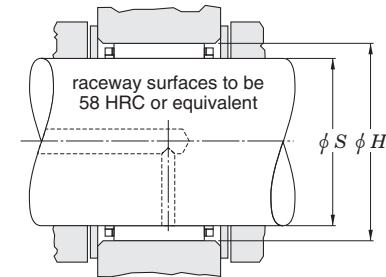
Shaft dia. 70 ~ 95 mm



K



K ZW

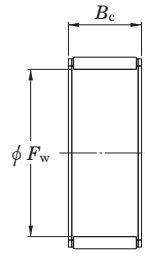


Shaft dia.	Boundary dimensions (mm)			Bearing No.	Basic load ratings (kN)		Fatigue load limit (kN) C <sub>u</sub>	Cage material <sup>1)</sup> P / S	Limiting speeds (min <sup>-1</sup> )		(Refer.) Mass (kg)	Recommended dimensions (mm)			
	F <sub>w</sub>	E <sub>w</sub>	B <sub>c</sub> -0.20 -0.55		C <sub>r</sub>	C <sub>0r</sub>			Grease lub.	Oil lub.		S (Shaft)		H (Housing)	
												max.	min.	max.	min.
70	70	76	20	K70X76X20	36.1	84.7	13.5	S	3 900	5 900	0.065	70.000	69.987	76.029	76.010
	70	76	30	K70X76X30	51.6	134.0	20.9	S	3 900	5 900	0.097	70.000	69.987	76.029	76.010
	70	78	20	K70X78X20H	43.6	87.9	14.0	S	3 900	6 000	0.090	70.000	69.987	78.029	78.010
	70	78	23	K70X78X23F	49.8	104.0	16.6	S	3 900	6 000	0.115	70.000	69.987	78.029	78.010
	70	78	24.8	K70X78X25F	49.8	104.0	16.6	S	3 900	6 000	0.115	70.000	69.987	78.029	78.010
	70	78	30	K70X78X30H	62.2	139.0	21.8	S	3 900	6 000	0.140	70.000	69.987	78.029	78.010
	70	78	46	K70X78X46ZW	78.4	187.0	29.5	S	3 900	6 000	0.188	70.000	69.987	78.029	78.010
	70	85	40	K70X85X40F	118	203	32.4	S	4 100	6 300	0.338	70.000	69.987	85.034	85.012
	70	88	30	K70X88X30H	115	175	28.1	S	4 100	6 400	0.205	70.000	69.987	88.034	88.012
72	72	80	20	K72X80X20	44.4	90.7	14.5	S	3 800	5 800	0.084	72.000	71.987	80.029	80.010
73	73	79	20	K73X79X20	37.0	88.7	14.1	S	3 700	5 700	0.068	73.000	72.987	79.029	79.010
75	75	81	20	K75X81X20F	37.4	90.7	14.5	S	3 600	5 500	0.075	75.000	74.987	81.034	81.012
	75	83	23	K75X83X23	52.5	114.0	18.2	S	3 600	5 600	0.104	75.000	74.987	83.034	83.012
	75	83	30	K75X83X30	60.9	138	21.7	S	3 600	5 600	0.141	75.000	74.987	83.034	83.012
	75	83	30	K75X83X30FH	60.9	138	21.7	S	3 600	5 600	0.141	75.000	74.987	83.034	83.012
80	80	86	20	K80X86X20H	38.6	96.7	15.4	S	3 400	5 200	0.072	80.000	79.987	86.034	86.012
	80	88	25	K80X88X25FV1	54.0	121	19.2	S	3 400	5 200	0.134	80.000	79.987	88.034	88.012
	80	88	30	K80X88X30	67.5	161	25.4	S	3 400	5 200	0.153	80.000	79.987	88.034	88.012
85	85	92	20	K85X92X20H	39.9	91.7	14.6	S	3 200	4 900	0.085	84.988	84.973	92.034	92.012
	85	93	25	K85X93X25F	58.8	138	21.7	S	3 200	4 900	0.128	84.988	84.973	93.034	93.012
	85	93	30	K85X93X30H	69.4	170.4	26.8	S	3 200	4 900	0.166	84.988	84.973	93.034	93.012
90	90	97	20	K90X97X20	46.3	114	18.1	S	3 000	4 600	0.095	89.988	89.973	97.034	97.012
	90	98	25	K90X98X25F	54.8	128	20.3	S	3 000	4 600	0.134	89.988	89.973	98.034	98.012
	90	98	30	K90X98X30	63.6	155	24.3	S	3 000	4 600	0.168	89.988	89.973	98.034	98.012
95	95	103	20	K95X103X20	49.3	114	18.3	S	2 800	4 400	0.130	94.988	94.973	103.034	103.012
	95	103	30	K95X103X30F	71.0	183	28.6	S	2 800	4 400	0.180	94.988	94.973	103.034	103.012

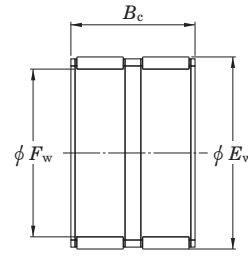
[Note] 1) Cage material: P: polymer cage, S: steel cage

**Radial needle roller and cage assemblies**  
**single-row, double-row assemblies**  
**metric series**  
**K, K ZW series**

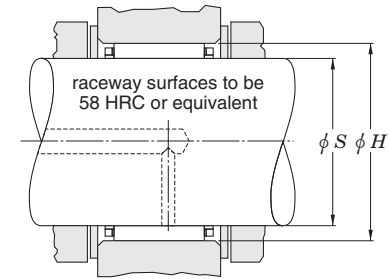
Shaft dia. 100 ~ 110 mm



K



K ZW



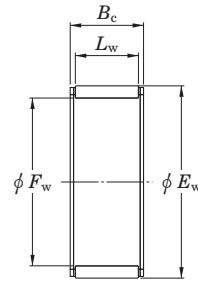
Shaft dia.	Boundary dimensions (mm)			Bearing No.	Basic load ratings (kN)		Fatigue load limit (kN) <i>C<sub>u</sub></i>	Cage material <sup>1)</sup> P / S	Limiting speeds (min <sup>-1</sup> )		(Refer.) Mass (kg)	Recommended dimensions (mm)			
	<i>F<sub>w</sub></i>	<i>E<sub>w</sub></i>	<i>B<sub>c</sub></i> -0.20 -0.55		<i>C<sub>r</sub></i>	<i>C<sub>0r</sub></i>			Grease lub.	Oil lub.		<i>S</i> (Shaft)		<i>H</i> (Housing)	
	max.	min.										max.	min.	max.	min.
100	100	108	30	<b>K100X108X30</b>	72.4	191	29.5	S	2 700	4 200	0.210	99.988	99.973	108.034	108.012
110	110	118	24	<b>K110X118X24</b>	64.0	168	25.6	S	2 400	3 800	0.165	109.988	109.973	118.034	118.012
	110	118	30	<b>K110X118X30H</b>	75.3	207	31.2	S	2 400	3 800	0.200	109.988	109.973	118.034	118.012

[Note] 1) Cage material: P: polymer cage, S: steel cage

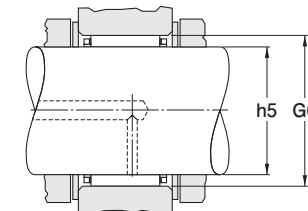


**Radial needle roller and cage assemblies**  
**single-row assemblies**  
**inch series**

Shaft dia.  $\frac{3}{8} \sim (1 \frac{1}{2})$  in  
 (9.525 ~ (38.100) mm)



WJ, WJC



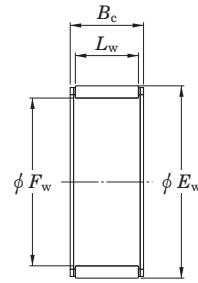
raceway surfaces to be  
 58 HRC or equivalent

Boundary dimensions (mm)				Bearing No.	Basic load ratings (kN)		Fatigue load limit (kN) $C_u$	Limiting speeds (min <sup>-1</sup> )		Recommended dimensions (mm)				(Refer.) Mass (kg)
Shaft dia. (in)	$F_w$	$E_w$	$B_c$ $^{+0}_{-0.38}$		$C_r$	$C_{Or}$		Grease lub.	Oil lub.	Shaft dia. (h5)		Housing bore dia. (G6)		
									max.	min.	max.	min.		
$\frac{3}{8}$	9.525	12.700	9.53	<b>WJC-060806</b>	3.87	4.00	0.600	24 000	37 000	9.525	9.520	12.715	12.705	0.003
$\frac{1}{2}$	12.700	15.875	12.70	<b>WJC-081008</b>	6.23	8.01	1.65	23 000	35 000	12.700	12.692	15.890	15.880	0.005
$\frac{9}{16}$	14.288	17.463	12.70	<b>WJC-091108</b>	6.81	9.25	1.40	22 000	34 000	14.288	14.280	17.478	17.468	0.006
$\frac{5}{8}$	15.875	19.050	12.70	<b>WJC-101208</b>	7.03	9.96	1.50	18 000	27 000	15.875	15.867	19.070	19.058	0.006
	15.875	22.225	15.88	<b>WJ-101410</b>	15.6	17.8	2.80	19 000	29 000	15.875	15.867	22.245	22.233	0.012
	15.875	22.225	22.23	<b>WJ-101414</b>	21.3	26.4	4.10	19 000	29 000	15.875	15.867	22.245	22.233	0.017
$\frac{3}{4}$	19.050	25.400	25.40	<b>WJ-121616</b>	26.8	37.2	5.80	16 000	24 000	19.050	19.040	25.420	25.408	0.023
$\frac{13}{16}$	20.638	26.988	22.23	<b>WJ-131714</b>	25.1	35.0	5.50	14 000	22 000	20.638	20.627	27.008	26.995	0.021
$\frac{7}{8}$	22.225	28.575	25.40	<b>WJ-141816</b>	29.2	43.5	6.75	13 000	20 000	22.225	22.215	28.595	28.583	0.026
1	25.400	33.338	19.05	<b>WJ-162112</b>	28.1	37.1	5.90	12 000	18 000	25.400	25.390	33.363	33.348	0.029
	25.400	33.338	25.40	<b>WJ-162116</b>	36.8	52.5	8.20	12 000	18 000	25.400	25.390	33.363	33.348	0.038
	25.400	33.338	31.75	<b>WJ-162120</b>	44.5	67.2	10.5	12 000	18 000	25.400	25.390	33.363	33.348	0.048
$1 \frac{1}{8}$	28.575	38.100	25.40	<b>WJ-182416</b>	42.4	57.8	9.05	10 000	16 000	28.575	28.565	38.125	38.110	0.041
	28.575	38.100	31.75	<b>WJ-182420</b>	52.0	74.7	11.7	10 000	16 000	28.575	28.565	38.125	38.110	0.065
$1 \frac{1}{4}$	31.750	41.275	19.05	<b>WJ-202612</b>	33.4	43.7	7.05	9 300	14 000	31.750	31.740	41.300	41.285	0.043
	31.750	41.275	25.40	<b>WJ-202616</b>	44.1	62.3	9.80	9 300	14 000	31.750	31.740	41.300	41.285	0.061
	31.750	41.275	31.75	<b>WJ-202620</b>	53.8	81.0	12.6	9 300	14 000	31.750	31.740	41.300	41.285	0.071
	31.750	41.275	38.10	<b>WJ-202624</b>	63.6	99.6	15.6	9 300	14 000	31.750	31.740	41.300	41.285	0.085
$1 \frac{3}{8}$	34.925	44.450	25.40	<b>WJ-222816</b>	45.8	67.2	10.5	8 300	13 000	34.925	34.915	44.475	44.460	0.067
	34.925	44.450	31.75	<b>WJ-222820</b>	56.0	87.2	13.6	8 300	13 000	34.925	34.915	44.475	44.460	0.077
$1 \frac{1}{2}$	38.100	47.625	25.40	<b>WJ-243016</b>	47.2	71.6	11.3	7 600	12 000	38.100	38.090	47.650	47.635	0.078
	38.100	47.625	31.75	<b>WJ-243020</b>	57.8	93.0	14.5	7 600	12 000	38.100	38.090	47.650	47.635	0.083

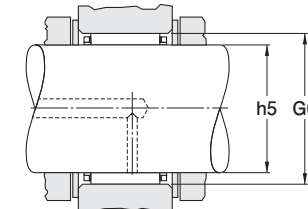
(Remarks) 1) Load ratings are based on a minimum raceway hardness of 58 HRC or equivalent.  
 2) Minimum axial clearance should be 0.02 mm (0.008 in).

**Radial needle roller and cage assemblies**  
**single-row assemblies**  
**inch series**

Shaft dia. (1 1/2) ~ 3 in  
 ((38.100) ~ 76.200 mm)



WJ, WJC



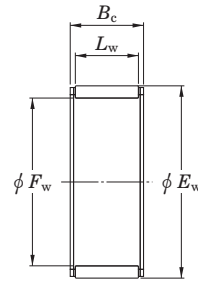
raceway surfaces to be  
58 HRC or equivalent

Shaft dia. (in)	Boundary dimensions (mm)			Bearing No.	Basic load ratings (kN)		Fatigue load limit (kN) Cu	Limiting speeds (min <sup>-1</sup> )		Recommended dimensions (mm)				(Refer.) Mass (kg)
	Fw	Ew	Bc +0 -0.38		Cr	Cor		Grease lub.	Oil lub.	Shaft dia. (h5)		Housing bore dia. (G6)		
										max.	min.	max.	min.	
1 1/2	38.100	47.625	38.10	<b>WJ-243024</b>	68.1	114.8	18.0	7 600	12 000	38.100	38.090	47.650	47.635	0.100
	38.100	47.625	44.45	<b>WJ-243028</b>	77.4	135.7	21.2	7 600	12 000	38.100	38.090	47.650	47.635	0.134
1 3/4	44.450	53.975	19.05	<b>WJ-283412</b>	39.5	59.6	9.60	6 400	9 900	44.450	44.440	54.003	53.985	0.058
	44.450	53.975	25.40	<b>WJ-283416</b>	52.0	85.0	13.4	6 400	9 900	44.450	44.440	54.003	53.985	0.084
	44.450	53.975	38.10	<b>WJ-283424</b>	74.7	136	21.3	6 400	9 900	44.450	44.440	54.003	53.985	0.115
2	50.800	60.325	19.05	<b>WJ-323812</b>	42.8	69.0	11.1	5 600	8 600	50.800	50.787	60.353	60.335	0.065
	50.800	60.325	25.40	<b>WJ-323816</b>	56.5	98.0	15.5	5 600	8 600	50.800	50.787	60.353	60.335	0.105
	50.800	60.325	31.75	<b>WJ-323820</b>	69.0	127	20.0	5 600	8 600	50.800	50.787	60.353	60.335	0.108
	50.800	60.325	38.10	<b>WJ-323824</b>	81.0	157	24.6	5 600	8 600	50.800	50.787	60.353	60.335	0.130
2 1/16	52.388	61.913	25.40	<b>WJ-333916</b>	57.8	102	16.2	5 400	8 300	52.388	52.375	61.940	61.923	0.099
2 1/8	53.975	63.500	25.40	<b>WJ-344016</b>	52.5	92.08	14.6	5 200	8 000	53.975	53.962	63.528	63.510	0.089
	53.975	63.500	38.10	<b>WJ-344024</b>	78.3	153	24.0	5 200	8 000	53.975	53.962	63.528	63.510	0.137
2 3/16	55.563	65.088	19.05	<b>WJ-354112</b>	44.5	75.17	12.2	5 000	7 800	55.563	55.550	65.115	65.098	0.070
	55.563	65.088	25.40	<b>WJ-354116</b>	57.8	107	16.9	5 000	7 800	55.563	55.550	65.115	65.098	0.094
2 1/4	57.150	66.675	25.40	<b>WJ-364216</b>	53.8	96.08	15.2	4 900	7 500	57.150	57.137	66.703	66.685	0.096
	57.150	66.675	31.75	<b>WJ-364220</b>	67.6	128	20.1	4 900	7 500	57.150	57.137	66.703	66.685	0.120
2 3/8	60.325	69.850	38.10	<b>WJ-384424</b>	81.4	167	26.1	4 600	7 100	60.325	60.312	69.878	69.860	0.151
2 1/2	63.500	73.025	25.40	<b>WJ-404616</b>	55.6	104	16.5	4 400	6 700	63.500	63.487	73.053	73.035	0.106
	63.500	73.025	31.75	<b>WJ-404620</b>	69.8	139	21.8	4 400	6 700	63.500	63.487	73.053	73.035	0.132
	63.500	73.025	38.10	<b>WJ-404624</b>	83.2	173	27.2	4 400	6 700	63.500	63.487	73.053	73.035	0.179
2 3/4	69.850	79.375	25.40	<b>WJ-445016</b>	57.8	112.54	17.8	4 000	6 100	69.850	69.837	79.403	79.385	0.116
3	76.200	85.725	25.40	<b>WJ-485416</b>	59.6	120.55	19.1	3 600	5 600	76.200	76.187	85.761	85.738	0.126
	76.200	85.725	38.10	<b>WJ-485424</b>	85.4	191.72	29.9	3 600	5 600	76.200	76.187	85.761	85.738	0.189

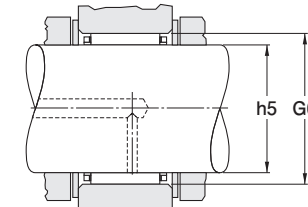
[Remarks] 1) Load ratings are based on a minimum raceway hardness of 58 HRC or equivalent.  
 2) Minimum axial clearance should be 0.02 mm (0.008 in).

Radial needle roller and cage assemblies  
single-row assemblies  
inch series

Shaft dia. 3 1/4 ~ 5 in  
(82.550 ~ 127.000 mm)



WJ, WJC



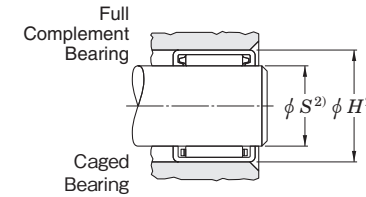
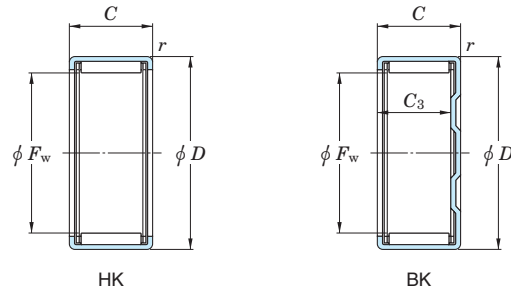
raceway surfaces to be  
58 HRC or equivalent

Shaft dia. (in)	Boundary dimensions (mm)			Bearing No.	Basic load ratings (kN)		Fatigue load limit (kN) Cu	Limiting speeds (min <sup>-1</sup> )		Recommended dimensions (mm)				(Refer.) Mass (kg)
	Fw	Ew	Bc +0 -0.38		Cr	Cor		Grease lub.	Oil lub.	Shaft dia. (h5)		Housing bore dia. (G6)		
										max.	min.	max.	min.	
3 1/4	82.550	92.075	25.40	<b>WJ-525816</b>	61.4	128.55	20.4	3 300	5 100	82.550	82.535	92.111	92.088	0.136
	82.550	92.075	38.10	<b>WJ-525824</b>	88.1	204.62	31.9	3 300	5 100	82.550	82.535	92.111	92.088	0.220
3 1/2	88.900	98.425	25.40	<b>WJ-566216</b>	63.2	136.56	21.7	3 100	4 700	88.900	88.885	98.461	98.438	0.146
	88.900	101.600	25.40	<b>WJ-566416</b>	79.6	150.35	23.9	3 100	4 800	88.900	88.885	101.636	101.613	0.197
	88.900	101.600	38.10	<b>WJ-566424</b>	113	237.53	37.4	3 100	4 800	88.900	88.885	101.636	101.613	0.296
4	101.600	114.300	25.40	<b>WJ-647216</b>	83.6	166.59	30.9	2 700	4 200	101.600	101.585	114.336	114.313	0.224
	101.600	114.300	38.10	<b>WJ-647224</b>	119	263.33	40.6	2 700	4 200	101.600	101.585	114.336	114.313	0.335
5	127.000	152.400	38.10	<b>WJ-809624</b>	211	365.20	51.9	2 200	3 400	127.000	126.982	152.438	152.415	1.018

[Remarks] 1) Load ratings are based on a minimum raceway hardness of 58 HRC or equivalent.  
2) Minimum axial clearance should be 0.02 mm (0.008 in).

**Drawn cup needle roller bearings**  
**caged,**  
**open ends, closed one end**  
**metric series**  
**HK, BK series**

Shaft dia. 3 ~ (10) mm



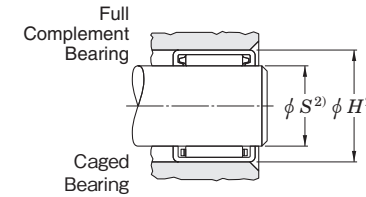
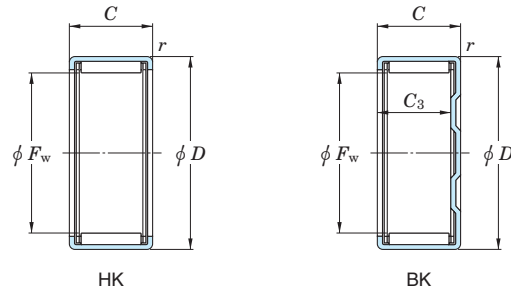
Shaft surface to be 58 HRC or equivalent

Shaft dia.	Boundary dimensions (mm)					Bearing No.	Basic load ratings (kN)		Fatigue load limit (kN)	Limiting speeds (min <sup>-1</sup> )		(Refer.) Mass (kg)	Inspection gage	Mounting inner ring (pages B458 to B467)
	F <sub>w</sub>	D	C <sub>+0</sub> -0.3	C <sub>min.</sub>	r <sub>min.</sub>		C <sub>r</sub>	C <sub>0r</sub>	C <sub>u</sub>	Grease lub.	Oil lub.			
3	3	6.5	6	5.20	0.30	<b>BK0306</b>	1.20	0.78	0.130	30 000	46 000	0.001	Table 4	
	3	6.5	6	—	0.30	<b>HK0306</b>	1.60	1.14	0.130	30 000	46 000	0.001	Table 4	
4	4	8	8	6.40	0.40	<b>BK0408</b>	1.83	1.32	0.200	25 000	39 000	0.002	Table 4	
	4	8	8	—	0.40	<b>HK0408</b>	1.88	1.38	0.200	25 000	39 000	0.002	Table 4	
5	5	9	9	7.40	0.40	<b>BK0509</b>	2.52	2.07	0.320	23 000	36 000	0.002	Table 4	
	5	9	9	—	0.40	<b>HK0509</b>	2.52	2.07	0.320	23 000	36 000	0.002	Table 4	
6	6	10	8	6.40	0.40	<b>BK0608</b>	2.34	1.95	0.290	22 000	33 000	0.002	Table 4	
	6	10	8	—	0.40	<b>HK0608</b>	2.34	1.95	0.290	22 000	33 000	0.002	Table 4	
	6	10	9	7.40	0.40	<b>BK0609</b>	3.14	2.85	0.290	22 000	33 000	0.003	Table 4	
	6	10	9	—	0.40	<b>HK0609</b>	3.14	2.85	0.290	22 000	33 000	0.002	Table 4	
7	7	11	9	7.40	0.40	<b>BK0709</b>	3.24	3.10	0.470	21 000	32 000	0.003	Table 4	
	7	11	9	—	0.40	<b>HK0709</b>	3.23	3.05	0.470	21 000	32 000	0.003	Table 4	
8	8	12	8	6.40	0.40	<b>BK0808</b>	2.90	2.73	0.400	20 000	31 000	0.003	Table 4	
	8	12	8	—	0.40	<b>HK0808</b>	2.90	2.73	0.400	20 000	31 000	0.003	Table 4	
	8	12	10	8.40	0.40	<b>BK0810</b>	3.93	4.14	0.600	20 000	31 000	0.004	Table 4	JR5x8x12
	8	12	10	—	0.40	<b>HK0810</b>	3.95	4.07	0.600	20 000	31 000	0.004	Table 4	JR5x8x12
9	9	13	10	8.40	0.40	<b>BK0910</b>	4.57	5.07	0.770	19 000	30 000	0.004	Table 4	JR6x9x12
	9	13	10	—	0.40	<b>HK0910</b>	4.57	5.07	0.770	19 000	30 000	0.004	Table 4	JR6x9x12
	9	13	12	10.40	0.40	<b>BK0912</b>	5.65	6.65	1.00	19 000	30 000	0.005	Table 4	JR6x9x12
	9	13	12	—	0.40	<b>HK0912</b>	5.65	6.65	1.00	19 000	30 000	0.005	Table 4	JR6x9x12
10	10	14	10	8.40	0.40	<b>BK1010</b>	4.78	5.51	0.840	19 000	29 000	0.004	Table 4	JR7x10x10,5
	10	14	10	—	0.40	<b>HK1010</b>	4.78	5.51	0.840	19 000	29 000	0.004	Table 4	JR7x10x10,5
	10	14	12	10.40	0.40	<b>BK1012</b>	5.90	7.23	1.10	19 000	29 000	0.006	Table 4	JR7x10x12
	10	14	12	—	0.40	<b>HK1012</b>	5.90	7.23	1.10	19 000	29 000	0.005	Table 4	JR7x10x12

[Notes] 1) Drawn cup needle roller bearings with two needle roller and cage assemblies and one lubricating hole.  
 2) For the recommended mounting dimensions see Table 20.

**Drawn cup needle roller bearings**  
**caged,**  
**open ends, closed one end**  
**metric series**  
**HK, BK series**

Shaft dia. (10) ~ (18) mm



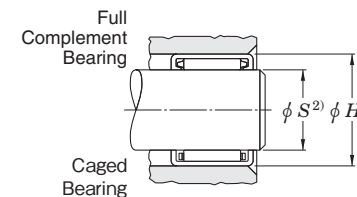
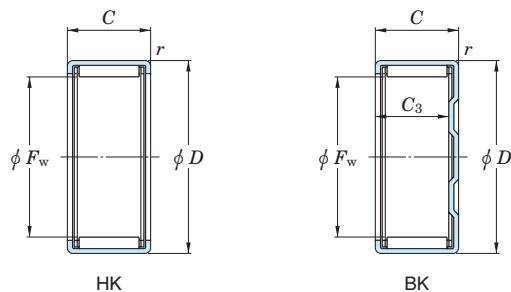
Shaft surface to be 58 HRC or equivalent

Shaft dia.	Boundary dimensions (mm)					Bearing No.	Basic load ratings (kN)		Fatigue load limit (kN)	Limiting speeds (min <sup>-1</sup> )		(Refer.) Mass (kg)	Inspection gage	Mounting inner ring (pages B458 to B467)
	F <sub>w</sub>	D	C +0 -0.3	C <sub>3</sub> min.	r min.		C <sub>r</sub>	C <sub>0r</sub>	C <sub>u</sub>	Grease lub.	Oil lub.			
10	10	14	15	13.40	0.40	BK1015	7.49	9.81	1.50	19 000	29 000	0.006	Table 4	JR7x10x16
	10	14	15	—	0.40	HK1015	7.49	9.81	1.50	19 000	29 000	0.006	Table 4	JR7x10x16
12	12	16	10	8.40	0.4	BK1210	4.96	6.08	0.890	18 000	28 000	0.006	Table 4	JR8x12x10,5
	12	16	10	—	0.4	HK1210	4.96	6.08	0.890	18 000	28 000	0.006	Table 4	JR8x12x10,5
	12	18	12	9.30	1	BK1212	6.61	7.29	1.10	14 000	22 000	0.012	Table 4	JR8x12x12,5
	12	18	12	—	1	HK1212	6.61	7.29	1.10	14 000	22 000	0.01	Table 4	JR8x12x12,5
13	13	19	12	9.30	1	BK1312	6.92	7.89	1.20	14 000	22 000	0.012	Table 4	JR10x13x12,5
	13	19	12	—	1	HK1312	6.92	7.89	1.20	14 000	22 000	0.01	Table 4	JR10x13x12,5
14	14	20	12	9.30	1	BK1412	7.21	8.50	1.30	14 000	21 000	0.014	Table 4	JR10x14x12
	14	20	12	—	1	HK1412	7.21	8.50	1.30	14 000	21 000	0.011	Table 4	JR10x14x12
15	15	21	12	9.30	1	BK1512	7.16	8.57	1.40	14 000	21 000	0.015	Table 4	JR12x15x12,5
	15	21	12	—	1	HK1512	7.49	9.11	1.40	14 000	21 000	0.012	Table 4	JR12x15x12,5
	15	21	16	13.30	1	BK1516	10.70	14.4	2.20	14 000	21 000	0.019	Table 4	JR12x15x16,5
	15	21	16	—	1	HK1516	10.70	14.4	2.20	14 000	21 000	0.018	Table 4	JR12x15x16,5
	15	21	22	19.30	1	BK1522 <sup>1)</sup>	13.50	19.4	2.95	14 000	21 000	0.022	Table 4	JR12x15x22,5
	15	21	22	—	1	HK1522 <sup>1)</sup>	13.50	19.4	2.95	14 000	21 000	0.024	Table 4	JR12x15x22,5
16	16	22	12	9.30	1	BK1612	7.76	9.72	1.50	14 000	21 000	0.016	Table 4	JR12x16x12
	16	22	12	—	1	HK1612	7.76	9.72	1.50	14 000	21 000	0.012	Table 4	JR12x16x12
	16	22	16	13.30	1	BK1616	11.1	15.3	2.35	14 000	21 000	0.02	Table 4	JR12x16x16
	16	22	16	—	1	HK1616	11.1	15.3	2.35	14 000	21 000	0.016	Table 4	JR12x16x16
	16	22	22	19.30	1	BK1622 <sup>1)</sup>	13.4	19.5	2.95	14 000	21 000	0.028	Table 4	JR12x16x22
	16	22	22	—	1	HK1622 <sup>1)</sup>	13.40	19.5	2.95	14 000	21 000	0.022	Table 4	JR12x16x22
17	17	23	12	9.30	1	BK1712	8.12	10.4	1.60	13 000	20 000	0.018	Table 4	
	17	23	12	—	1	HK1712	8.12	10.4	1.60	13 000	20 000	0.013	Table 4	
18	18	24	12	9.30	1	BK1812	8.41	11.11	1.70	12 000	18 000	0.017	Table 4	

[Notes] 1) Drawn cup needle roller bearings with two needle roller and cage assemblies and one lubricating hole.  
 2) For the recommended mounting dimensions see Table 20.

**Drawn cup needle roller bearings**  
**caged,**  
**open ends, closed one end**  
**metric series**  
**HK, BK series**

Shaft dia. (18) ~ (25) mm



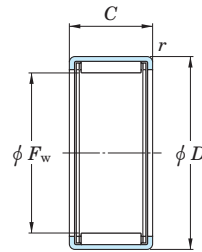
Shaft surface to be  
58 HRC or equivalent

Shaft dia.	Boundary dimensions (mm)					Bearing No.	Basic load ratings (kN)		Fatigue load limit (kN)	Limiting speeds (min <sup>-1</sup> )		(Refer.) Mass (kg)	Inspection gage	Mounting inner ring (pages B458 to B467)
	$F_w$	$D$	$C$ +0 -0.3	$C_3$ min.	$r$ min.		$C_r$	$C_{Or}$	$C_u$	Grease lub.	Oil lub.			
18	18	24	12	—	1	HK1812	8.41	11.11	1.70	12 000	18 000	0.015	Table 4	JR15x18x16,5 JR15x18x16,5
	18	24	16	13.30	1	BK1816	11.6	16.8	2.55	12 000	18 000	0.022	Table 4	
	18	24	16	—	1	HK1816	11.6	16.8	2.55	12 000	18 000	0.018	Table 4	
20	20	26	12	9.3	1	BK2012	8.97	12.5	1.90	11 000	16 000	0.017	Table 4	JR15x20x12 JR15x20x12 JR17x20x16,5 JR17x20x16,5 JR17x20x20,5 JR17x20x20,5 JR17x20x30,5 JR17x20x30,5
	20	26	12	—	1	BK2012	8.97	12.5	1.90	11 000	16 000	0.015	Table 4	
	20	26	16	13.3	1	BK2016	12.40	18.90	2.85	11 000	16 000	0.024	Table 4	
	20	26	16	—	1	HK2016	12.40	18.90	2.85	11 000	16 000	0.022	Table 4	
	20	26	20	17.3	1	BK2020	15.50	25.30	3.95	11 000	16 000	0.027	Table 4	
	20	26	20	—	1	HK2020	15.90	26.20	3.95	11 000	16 000	0.025	Table 4	
	20	26	30	27.3	1	BK2030 <sup>1)</sup>	21.20	37.80	5.75	11 000	16 000	0.043	Table 4	
	20	26	30	—	1	HK2030 <sup>1)</sup>	21.20	37.80	5.75	11 000	16 000	0.041	Table 4	
22	22	28	10	8.4	1	BK2210	7.06	9.49	1.45	9 600	15 000	0.013	Table 4	JR17x22x13 JR17x22x13 JR17x22x13 JR17x22x16 JR17x22x16 JR17x22x23 JR17x22x23
	22	28	10	—	1	HK2210	7.06	9.49	1.45	9 600	15 000	0.013	Table 4	
	22	28	12	9.3	1	BK2212	9.81	14.50	2.20	9 600	15 000	0.02	Table 4	
	22	28	12	—	1	HK2212	9.81	14.50	2.20	9 600	15 000	0.015	Table 4	
	22	28	16	13.3	1	BK2216	13.10	20.90	3.20	9 600	15 000	0.027	Table 4	
	22	28	16	—	1	HK2216	13.10	20.90	3.20	9 600	15 000	0.022	Table 4	
	22	28	20	17.3	1	BK2220	15.30	25.50	4.00	9 600	15 000	0.028	Table 4	
	22	28	20	—	1	HK2220	15.30	25.50	4.00	9 600	15 000	0.026	Table 4	
25	25	32	12	9.30	1	BK2512	10.90	14.70	2.25	8 500	13 000	0.025	Table 4	JR20x25x17 JR20x25x17 JR20x25x20,5 JR20x25x20,5 JR20x25x26,5 JR20x25x26,5
	25	32	12	—	1	HK2512	10.90	14.70	2.25	8 500	13 000	0.021	Table 4	
	25	32	16	13.3	1	BK2516	15.60	23.50	3.55	8 500	13 000	0.031	Table 4	
	25	32	16	—	1	HK2516	15.60	23.50	3.55	8 500	13 000	0.028	Table 4	
	25	32	20	17.3	1	BK2520	20.60	33.40	5.30	8 500	13 000	0.043	Table 4	
	25	32	20	—	1	HK2520	20.60	33.40	5.30	8 500	13 000	0.040	Table 4	
	25	32	26	23.3	1	BK2526	25.70	44.40	6.95	8 500	13 000	0.051	Table 4	
	25	32	26	—	1	HK2526	25.70	44.40	6.95	8 500	13 000	0.046	Table 4	

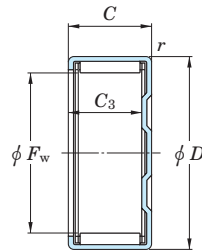
[Notes] 1) Drawn cup needle roller bearings with two needle roller and cage assemblies and one lubricating hole.  
 2) For the recommended mounting dimensions see Table 20.

**Drawn cup needle roller bearings**  
**caged,**  
**open ends, closed one end**  
**metric series**  
**HK, BK series**

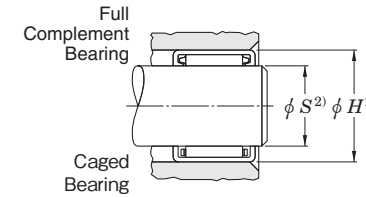
Shaft dia. (25) ~ (45) mm



HK



BK



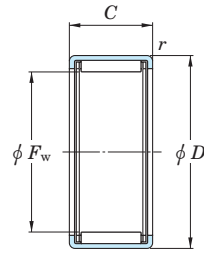
Shaft surface to be  
58 HRC or equivalent

Shaft dia.	Boundary dimensions (mm)					Bearing No.	Basic load ratings (kN)		Fatigue load limit (kN)	Limiting speeds (min <sup>-1</sup> )		(Refer.) Mass (kg)	Inspection gage	Mounting inner ring (pages B458 to B467)
	F <sub>w</sub>	D	C <sub>+0</sub> -0.3	C <sub>3</sub> min.	r min.		C <sub>r</sub>	C <sub>0r</sub>	C <sub>u</sub>	Grease lub.	Oil lub.			
25	25	32	38	35.3	1	<b>BK2538</b> <sup>1)</sup>	35.30	66.90	10.6	8 500	13 000	0.077	Table 4	JR20x25x38,5
	25	32	38	—	1	<b>HK2538</b> <sup>1)</sup>	35.30	66.90	10.6	8 500	13 000	0.068	Table 4	JR20x25x38,5
28	28	35	16	13.30	1	<b>BK2816</b>	15.9	24.9	3.85	7 500	12 000	0.038	Table 4	JR22x28x17
	28	35	16	—	1	<b>HK2816</b>	15.9	24.9	3.85	7 500	12 000	0.032	Table 4	JR22x28x17
	28	35	20	17.3	1	<b>BK2820</b>	20.9	35.3	5.60	7 500	12 000	0.047	Table 4	JR22x28x20,5
	28	35	20	—	1	<b>HK2820</b>	20.9	35.3	5.60	7 500	12 000	0.040	Table 4	JR22x28x20,5
30	30	37	12	9.3	1	<b>BK3012</b>	11.6	16.8	2.90	7 000	11 000	0.031	Table 4	JR25x30x17
	30	37	12	—	1	<b>HK3012</b>	12.0	17.7	2.70	7 000	11 000	0.024	Table 4	
	30	37	16	13.30	1	<b>BK3016</b>	16.8	27.3	4.20	7 000	11 000	0.041	Table 4	
	30	37	16	—	1	<b>HK3016</b>	16.8	27.3	4.20	7 000	11 000	0.032	Table 4	JR25x30x17
	30	37	20	17.3	1	<b>BK3020</b>	22.4	39.6	6.25	7 000	11 000	0.053	Table 4	JR25x30x20,5
	30	37	20	—	1	<b>HK3020</b>	22.4	39.6	6.25	7 000	11 000	0.042	Table 4	JR25x30x20,5
	30	37	26	23.3	1	<b>BK3026</b>	27.4	51.2	7.95	7 000	11 000	0.067	Table 4	JR25x30x26,5
	30	37	26	—	1	<b>HK3026</b>	27.4	51.2	7.95	7 000	11 000	0.054	Table 4	JR25x30x26,5
	30	37	38	35.3	1	<b>BK3038</b> <sup>1)</sup>	38.4	79.2	12.5	7 000	11 000	0.093	Table 4	JR25x30x38,5
30	37	38	—	1	<b>HK3038</b> <sup>1)</sup>	38.4	79.2	12.5	7 000	11 000	0.075	Table 4	JR25x30x38,5	
35	35	42	12	—	1	<b>HK3512</b>	13.0	20.6	2.90	5 900	9 100	0.028	Table 4	JR30x35x17
	35	42	16	—	1	<b>HK3516</b>	17.4	29.9	4.60	5 900	9 100	0.037	Table 4	
	35	42	20	17.3	1	<b>BK3520</b>	24.5	46.8	7.40	5 900	9 100	0.065	Table 4	
	35	42	20	—	1	<b>HK3520</b>	24.5	46.8	7.40	5 900	9 100	0.049	Table 4	
40	40	47	12	—	1	<b>HK4012</b>	14.7	25.3	3.40	5 200	7 900	0.033	Table 4	JR35x40x17
	40	47	16	—	1	<b>HK4016</b>	18.9	34.8	5.35	5 200	7 900	0.042	Table 4	
	40	47	20	17.3	1	<b>BK4020</b>	25.1	50.4	8.00	5 200	7 900	0.070	Table 4	
	40	47	20	—	1	<b>HK4020</b>	25.1	50.4	8.00	5 200	7 900	0.060	Table 4	
45	45	52	12	—	1	<b>HK4512</b>	14.1	24.8	3.75	4 600	7 000	0.036	Table 4	

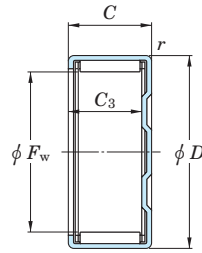
[Notes] 1) Drawn cup needle roller bearings with two needle roller and cage assemblies and one lubricating hole.  
 2) For the recommended mounting dimensions see Table 20.

**Drawn cup needle roller bearings**  
**caged,**  
**open ends, closed one end**  
**metric series**  
**HK, BK series**

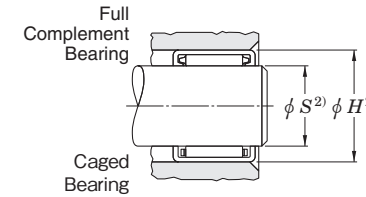
Shaft dia. (45) ~ 60 mm



HK



BK



Shaft surface to be  
58 HRC or equivalent

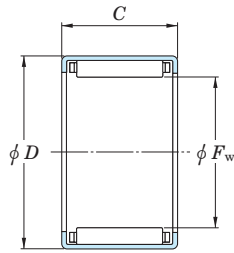
Shaft dia.	Boundary dimensions (mm)					Bearing No.	Basic load ratings (kN)		Fatigue load limit (kN)	Limiting speeds (min <sup>-1</sup> )		(Refer.) Mass (kg)	Inspection gage	Mounting inner ring (pages B458 to B467)
	F <sub>w</sub>	D	C +0 -0.3	C <sub>3</sub> min.	r min.		C <sub>r</sub>	C <sub>0r</sub>	C <sub>u</sub>	Grease lub.	Oil lub.			
45	45	52	16	—	1	<b>HK4516</b>	19.8	38.5	5.95	4 600	7 000	0.048	Table 4	JR40x45x17
	45	52	20	17.3	1	<b>BK4520</b>	26.3	55.4	8.80	4 600	7 000	0.079	Table 4	JR40x45x20,5
	45	52	20	—	1	<b>HK4520</b>	27.2	58.2	8.80	4 600	7 000	0.059	Table 4	JR40x45x20,5
50	50	58	12	—	1	<b>HK5012</b>	17.0	28.7	4.40	4 100	6 300	0.045	Table 4	
	50	58	20	—	1	<b>HK5020</b>	30.9	62.2	8.80	4 100	6 300	0.072	Table 4	JR45x50x20
	50	58	25	—	1	<b>HK5025</b>	35.5	74.1	11.7	4 100	6 300	0.092	Table 4	JR45x50x25,5
55	55	63	20	—	1	<b>HK5520</b>	31.0	64.4	10.0	3 700	5 700	0.079	Table 4	
60	60	68	12	—	1	<b>HK6012</b>	18.6	34.4	5.25	3 400	5 200	0.060	Table 4	
	60	68	20	—	1	<b>HK6020</b>	32.5	70.2	10.9	3 400	5 200	0.090	Table 4	

[Notes] 1) Drawn cup needle roller bearings with two needle roller and cage assemblies and one lubricating hole.  
 2) For the recommended mounting dimensions see Table 20.

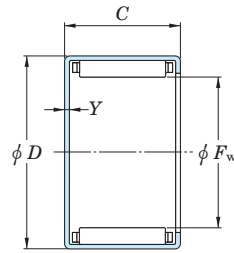


**Drawn cup needle roller bearings**  
**caged,**  
**open ends, closed one end**  
**inch series**  
**J, JH, MJ-1,**  
**MJH-1 series**

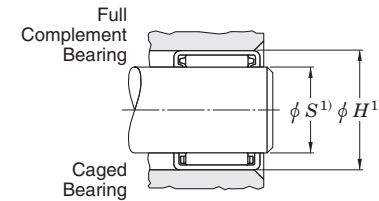
Shaft dia. 1/8 ~ 1/2 in  
 (3.175 ~ 12.700 mm)



J, JH



MJ-1, MJH-1



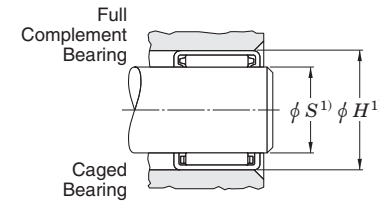
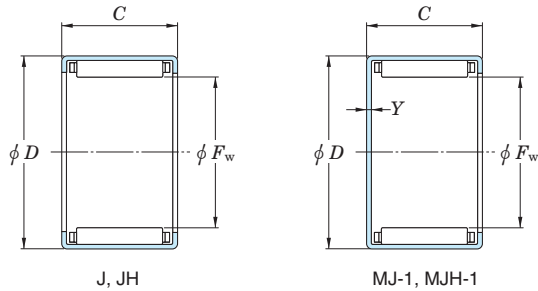
Shaft surface to be  
 58 HRC or equivalent

Shaft dia. (in)	Boundary dimensions (mm)				Bearing No.		Basic load ratings (kN)		Fatigue load limit (kN)	Limiting speeds (min <sup>-1</sup> )		(Refer.) Mass (kg)		Inspection gage
	$F_w$	$D$	$C$ <sub>+0 -0.3</sub>	$Y$ max.	With open ends	With closed end	$C_r$	$C_{Or}$	$C_u$	Grease lub.	Oil lub.	With open ends	With closed end	
1/8	3.175	6.350	4.78	—	<b>JP-23-F</b>	—	0.89	0.62	0.100	33 000	51 000	0.001	—	Table 5
	3.175	6.350	6.35	—	<b>JP-24-F</b>	—	1.33	1.02	0.150	33 000	51 000	0.001	—	Table 5
5/32	3.970	7.142	4.78	—	<b>JP-2 1/2 3F</b>	—	0.93	0.62	0.110	31 000	47 000	0.001	—	Table 5
3/16	4.763	8.733	4.77	—	<b>JP-33-F</b>	—	1.07	0.71	0.120	25 000	38 000	0.001	—	Table 5
	4.763	8.733	6.35	—	<b>JP-34-F</b>	—	1.60	1.25	0.200	25 000	38 000	0.001	—	Table 5
	4.763	8.733	9.53	1.02	<b>J-36</b>	<b>MJ-361</b>	2.27	1.91	0.290	25 000	38 000	0.002	0.002	Table 5
1/4	6.350	11.113	7.92	1.02	<b>J-45</b>	<b>MJ-451</b>	2.22	1.73	0.300	20 000	30 000	0.003	0.003	Table 5
	6.350	11.113	11.13	1.02	<b>J-47</b>	<b>MJ-471</b>	3.38	3.02	0.450	20 000	30 000	0.004	0.004	Table 5
5/16	7.938	12.700	7.92	—	<b>J-55</b>	—	2.40	2.00	0.340	18 000	28 000	0.003	—	Table 5
	7.938	12.700	11.13	1.02	<b>J-57</b>	<b>MJ-571</b>	4.05	3.91	0.590	18 000	28 000	0.004	0.005	Table 5
	7.938	14.288	11.13	1.02	<b>JH-57</b>	<b>MJH-571</b>	4.63	3.78	0.570	14 000	22 000	0.006	0.007	Table 5
3/8	9.525	14.288	7.92	1.02	<b>J-65</b>	<b>MJ-651</b>	2.76	2.49	0.430	18 000	27 000	0.004	0.004	Table 5
	9.525	14.288	9.53	1.02	<b>J-66</b>	<b>MJ-661</b>	3.51	3.47	0.530	18 000	27 000	0.004	0.005	Table 5
	9.525	14.288	12.70	1.02	<b>J-68</b>	<b>MJ-681</b>	5.20	5.74	0.860	18 000	27 000	0.005	0.006	Table 5
	9.525	15.875	12.70	—	<b>JH-68</b>	—	6.58	6.09	0.920	13 000	20 000	0.008	—	Table 5
7/16	11.113	15.875	12.70	1.02	<b>J-78</b>	<b>MJ-781</b>	6.36	7.70	1.15	17 000	26 000	0.006	0.007	Table 5
	11.113	17.463	12.70	—	<b>JH-78</b>	—	7.12	6.89	1.05	13 000	19 000	0.009	—	Table 5
1/2	12.700	17.463	7.92	1.02	<b>J-85</b>	<b>MJ-851</b>	3.47	3.65	0.630	16 000	25 000	0.005	0.005	Table 5
	12.700	17.463	9.53	1.02	<b>J-86</b>	<b>MJ-861</b>	4.67	5.38	0.830	16 000	25 000	0.005	0.006	Table 5
	12.700	17.463	12.70	1.02	<b>J-88</b>	<b>MJ-881</b>	6.32	7.92	1.20	16 000	25 000	0.007	0.008	Table 5
	12.700	17.463	19.05	—	<b>J-812</b>	—	10.23	14.72	2.25	16 000	25 000	0.010	—	Table 5
	12.700	19.050	11.13	1.02	<b>JH-87</b>	<b>MJH-871</b>	6.41	6.18	0.950	12 000	19 000	0.009	0.010	Table 5
	12.700	19.050	12.70	1.02	<b>JH-88</b>	<b>MJH-881</b>	7.56	7.70	1.15	12 000	19 000	0.010	0.012	Table 5
	12.700	19.050	19.05	—	<b>JH-812</b>	—	12.32	14.41	2.25	12 000	19 000	0.015	—	Table 5

[Note] 1) For the recommended mounting dimensions see Table 21.

**Drawn cup needle roller bearings**  
**caged,**  
**open ends, closed one end**  
**inch series**  
**J, JH, MJ-1,**  
**MJH-1 series**

Shaft dia.  $\frac{9}{16} \sim \frac{7}{8}$  in  
 (14.288 ~ 22.225 mm)



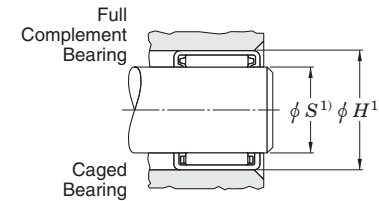
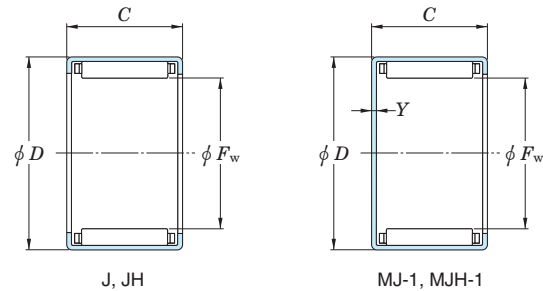
Shaft surface to be  
 58 HRC or equivalent

Shaft dia. (in)	Boundary dimensions (mm)				Bearing No.		Basic load ratings (kN)		Fatigue load limit (kN)	Limiting speeds (min <sup>-1</sup> )		(Refer.) Mass (kg)		Inspection gage
	$F_w$	$D$	$C$ $^{+0}_{-0.3}$	$Y$ max.	With open ends	With closed end	$C_r$	$C_{Or}$	$C_u$	Grease lub.	Oil lub.	With open ends	With closed end	
$\frac{9}{16}$	14.288	19.050	11.13	1.02	<b>J-97</b>	<b>MJ-971</b>	5.47	6.81	1.05	16 000	25 000	0.007	0.009	Table 5
	14.288	19.050	12.70	1.02	<b>J-98</b>	<b>MJ-981</b>	6.23	8.01	1.20	16 000	25 000	0.008	0.009	Table 5
	14.288	19.050	15.88	—	<b>J-910</b>	—	5.83	7.21	1.75	16 000	25 000	0.010	—	Table 5
	14.288	20.638	12.70	1.02	<b>JH-98</b>	<b>MJH-981</b>	8.01	8.50	1.30	12 000	18 000	0.011	0.014	Table 5
$\frac{5}{8}$	15.875	20.638	12.70	1.02	<b>J-108</b>	<b>MJ-1081</b>	6.72	9.12	1.40	13 000	21 000	0.009	0.010	Table 5
	15.875	20.638	15.88	1.02	<b>J-1010</b>	<b>MJ-10101</b>	8.81	12.94	1.95	13 000	21 000	0.010	0.013	Table 5
	15.875	20.638	19.05	1.02	<b>J-1012</b>	<b>MJ-10121</b>	11.74	18.86	2.90	13 000	21 000	0.013	0.015	Table 5
	15.875	22.212	15.88	1.02	<b>JH-1010</b>	<b>MJH-10101</b>	11.57	14.10	2.15	14 000	21 000	0.015	0.017	Table 5
	15.875	22.212	25.40	1.02	<b>JH-1016</b>	<b>MJH-10161</b>	19.79	28.11	4.35	14 000	21 000	0.024	0.028	Table 5
$\frac{11}{16}$	17.463	22.212	19.05	1.02	<b>J-1112</b>	<b>MJ-11121</b>	12.46	20.91	3.20	12 000	19 000	0.014	0.016	Table 5
	17.463	23.813	15.88	1.02	<b>JH-1110</b>	<b>MJH-11101</b>	12.05	15.21	2.30	13 000	19 000	0.016	0.019	Table 5
	17.463	23.813	19.05	—	<b>JH-1112</b>	—	16.15	22.20	3.10	13 000	19 000	0.019	—	Table 5
$\frac{3}{4}$	19.050	25.400	9.53	—	<b>J-126</b>	—	6.49	7.03	1.10	11 000	18 000	0.010	—	Table 5
	19.050	25.400	12.70	—	<b>J-128</b>	—	9.92	12.19	1.85	11 000	18 000	0.014	—	Table 5
	19.050	25.400	15.88	1.02	<b>J-1210</b>	<b>MJ-12101</b>	12.50	16.32	2.50	11 000	18 000	0.017	0.020	Table 5
	19.050	25.400	19.05	1.02	<b>J-1212</b>	<b>MJ-12121</b>	15.52	21.62	3.35	11 000	18 000	0.020	0.025	Table 5
	19.050	26.988	19.05	1.02	<b>JH-1212</b>	<b>MJH-12121</b>	19.08	23.58	3.70	12 000	18 000	0.026	0.031	Table 5
$\frac{13}{16}$	20.638	26.988	22.23	—	<b>J-1314</b>	—	19.31	29.31	4.55	10 000	16 000	0.025	—	Table 5
	20.638	28.575	19.05	1.27	<b>JH-1312</b>	<b>MJH-13121</b>	18.77	24.55	3.85	11 000	16 000	0.028	0.034	Table 5
$\frac{7}{8}$	22.225	28.575	9.53	—	<b>J-146</b>	—	7.21	8.41	1.30	9 700	15 000	0.012	—	Table 5
	22.225	28.575	12.70	—	<b>J-148</b>	—	10.94	14.50	2.20	9 700	15 000	0.015	—	Table 5
	22.225	28.575	19.05	1.02	<b>J-1412</b>	<b>MJ-14121</b>	17.88	27.18	4.20	9 700	15 000	0.024	0.028	Table 5
	22.225	28.575	25.40	1.02	<b>J-1416</b>	<b>MJ-14161</b>	23.66	38.97	6.05	9 700	15 000	0.031	0.059	Table 5
	22.225	30.163	19.05	1.27	<b>JH-1412</b>	<b>MJH-14121</b>	18.33	24.55	3.75	9 800	15 000	0.030	0.036	Table 5
	22.225	30.163	25.40	1.27	<b>JH-1416</b>	<b>MJH-14161</b>	25.40	37.37	5.80	9 800	15 000	0.040	0.048	Table 5

[Note] 1) For the recommended mounting dimensions see Table 21.

**Drawn cup needle roller bearings**  
**caged,**  
**open ends, closed one end**  
**inch series**  
**J, JH, MJ-1,**  
**MJH-1 series**

Shaft dia. 1 ~ (1 3/4) in  
 (25.400 ~ (44.450) mm)



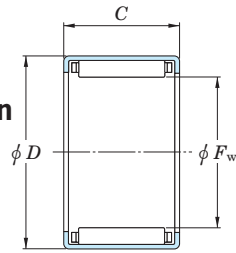
Shaft surface to be  
 58 HRC or equivalent

Shaft dia. (in)	Boundary dimensions (mm)				Bearing No.		Basic load ratings (kN)		Fatigue load limit (kN)	Limiting speeds (min <sup>-1</sup> )		(Refer.) Mass (kg)		Inspection gage
	F <sub>w</sub>	D	C +0 -0.3	Y max.	With open ends	With closed end	C <sub>r</sub>	C <sub>0r</sub>	C <sub>u</sub>	Grease lub.	Oil lub.	With open ends	With closed end	
1	25.400	31.750	19.05	—	<b>J-1612</b>	—	18.15	28.82	4.45	8 400	13 000	0.026	—	Table 5
	25.400	31.750	25.40	1.02	<b>J-1616</b>	<b>MJ-16161</b>	24.95	43.41	6.75	8 400	13 000	0.035	0.042	Table 5
	25.400	33.338	19.05	1.27	<b>JH-1612</b>	<b>MJH-16121</b>	20.68	29.58	4.60	8 500	13 000	0.034	0.040	Table 5
	25.400	33.338	25.40	1.27	<b>JH-1616</b>	<b>MJH-16161</b>	27.58	42.88	6.65	8 500	13 000	0.045	0.054	Table 5
1 1/8	28.575	34.925	12.70	1.02	<b>J-188</b>	<b>MJ-1881</b>	11.65	16.95	2.55	7 400	11 000	0.020	0.023	Table 5
	28.575	34.925	19.05	1.02	<b>J-1812</b>	<b>MJ-18121</b>	19.04	31.76	4.90	7 400	11 000	0.029	0.035	Table 5
	28.575	34.925	25.40	1.02	<b>J-1816</b>	<b>MJ-18161</b>	26.16	48.04	7.40	7 400	11 000	0.039	0.047	Table 5
	28.575	38.100	19.05	1.27	<b>JH-1812</b>	<b>MJH-18121</b>	23.35	31.32	4.75	7 600	12 000	0.046	0.055	Table 5
	28.575	38.100	25.40	1.27	<b>JH-1816</b>	<b>MJH-18161</b>	33.14	49.38	7.70	7 600	12 000	0.061	0.074	Table 5
	28.575	38.100	28.58	1.27	<b>JH-1818</b>	<b>MJH-18181</b>	36.30	55.16	8.60	7 600	12 000	0.069	0.082	Table 5
1 1/4	31.750	38.100	19.05	1.02	<b>J-2012</b>	<b>MJ-20121</b>	19.84	34.70	5.35	6 600	10 000	0.036	0.043	Table 5
	31.750	38.100	25.40	1.02	<b>J-2016</b>	<b>MJ-20161</b>	28.82	56.49	8.70	6 600	10 000	0.043	0.051	Table 5
	31.750	41.275	19.05	—	<b>JH-2012</b>	—	24.11	33.94	5.80	6 800	10 000	0.050	—	Table 5
	31.750	41.275	25.40	—	<b>JH-2016</b>	—	33.94	52.93	8.20	6 800	10 000	0.067	—	Table 5
	31.750	41.275	31.75	—	<b>JH-2020</b>	—	43.37	72.51	10.8	6 800	10 000	0.084	—	Table 5
1 3/8	34.925	41.275	12.70	1.02	<b>J-228</b>	<b>MJ-2281</b>	13.97	22.91	3.50	6 000	9 200	0.024	0.028	Table 5
	34.925	41.275	19.05	—	<b>J-2212</b>	—	22.82	42.97	6.65	6 000	9 200	0.035	—	Table 5
	34.925	44.450	19.05	1.27	<b>JH-2212</b>	<b>MJH-22121</b>	26.24	38.43	5.90	6 100	9 400	0.055	0.065	Table 5
	34.925	44.450	25.40	1.27	<b>JH-2216</b>	<b>MJH-22161</b>	36.52	58.72	9.20	6 100	9 400	0.073	0.087	Table 5
1 1/2	38.100	47.625	19.05	1.27	<b>J-2412</b>	<b>MJ-24121</b>	29.89	47.15	7.40	5 600	8 600	0.059	0.094	Table 5
	38.100	47.625	25.40	1.27	<b>J-2416</b>	<b>MJ-24161</b>	39.32	66.72	10.4	5 600	8 600	0.079	0.094	Table 5
	38.100	47.625	31.75	—	<b>J-2420</b>	—	49.38	89.85	14.0	5 600	8 600	0.099	—	Table 5
1 5/8	41.275	50.800	15.88	—	<b>J-2610</b>	—	26.11	40.97	6.25	5 100	7 900	0.053	—	Table 5
	41.275	50.800	25.40	1.27	<b>J-2616</b>	<b>M-26161</b>	39.28	68.95	10.8	5 100	7 900	0.085	0.101	Table 5
1 3/4	44.450	53.975	19.05	1.27	<b>J-2812</b>	<b>MJ-28121</b>	29.58	49.38	7.45	4 700	7 300	0.068	0.081	Table 5

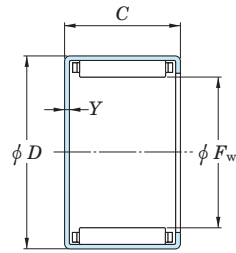
[Note] 1) For the recommended mounting dimensions see Table 21.

**Drawn cup needle roller bearings**  
**caged,**  
**open ends, closed one end**  
**inch series**  
**J, JH, MJ-1,**  
**MJH-1 series**

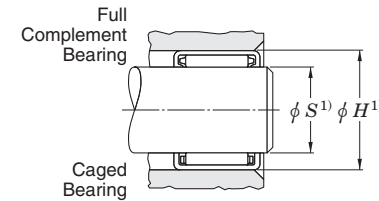
Shaft dia. (1 3/4) ~ 2 3/4 in  
 ((44.450) ~ 69.850 mm)



J, JH



MJ-1, MJH-1

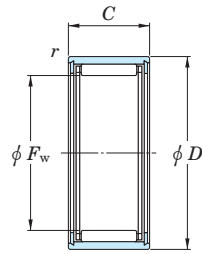


Shaft surface to be  
 58 HRC or equivalent

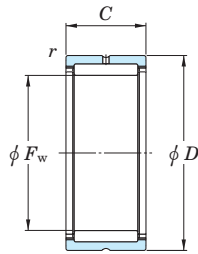
Shaft dia. (in)	Boundary dimensions (mm)				Bearing No.		Basic load ratings (kN)		Fatigue load limit (kN)	Limiting speeds (min <sup>-1</sup> )		(Refer.) Mass (kg)		Inspection gage
	$F_w$	$D$	$C$ <sub>+0 -0.3</sub>	$Y$ max.	With open ends	With closed end	$C_r$	$C_{0r}$	$C_u$	Grease lub.	Oil lub.	With open ends	With closed end	
1 3/4	44.450	53.975	25.40	1.27	<b>J-2816</b>	<b>MJ-28161</b>	40.08	72.95	11.4	4 700	7 300	0.091	0.108	Table 5
	44.450	53.975	38.10	1.27	<b>J-2824</b>	<b>MJ-28241</b>	59.61	121.88	18.9	4 700	7 300	0.136	0.162	Table 5
1 7/8	47.625	57.150	25.40	1.27	<b>J-3016</b>	<b>MJ-30161</b>	41.10	76.06	11.9	4 400	6 800	0.097	0.115	Table 5
2	50.800	60.325	25.40	1.27	<b>J-3216</b>	<b>MJ-32161</b>	42.39	81.40	12.7	4 100	6 300	0.103	0.137	Table 5
2 1/4	57.150	66.675	19.05	—	<b>J-3612</b>	—	35.41	65.83	10.0	3 600	5 600	0.086	—	Table 5
	57.150	66.675	25.40	—	<b>J-3616</b>	—	46.26	92.52	14.4	3 600	5 600	0.114	—	Table 5
2 3/4	69.850	79.375	19.05	—	<b>J-4412</b>	—	36.25	72.95	11.3	2 900	4 500	0.103	—	Table 5

[Note] 1) For the recommended mounting dimensions see Table 21.

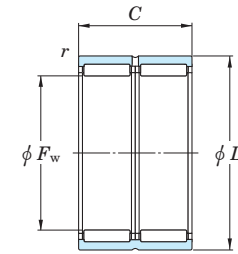
**Heavy-duty needle roller bearings  
without inner rings  
metric series  
NK, NKS, RNA48, RNA49  
RNA69, NKTN series**  
Shaft dia. 5 ~ (17) mm



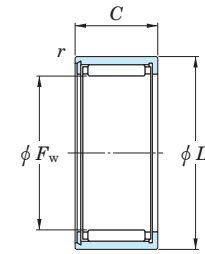
NK ( $\phi F_w \leq 10$ )



NK ( $\phi F_w \geq 12$ ), NKS, RNA48,  
RNA49, RNA69 ( $\phi F_w \leq 35$ )



RNA69  
( $\phi F_w \geq 40$ )



NKTN

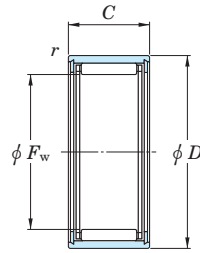
**Shaft dia. (17) ~ 25 mm**

Shaft dia.	Boundary dimensions (mm)				Bearing No.	Basic load ratings (kN)		Fatigue load limit (kN) $C_u$	Limiting speeds (min <sup>-1</sup> )		(Refer.) Mass (kg)
	$F_w$	$D$	$C$	$r_{min.}$		$C_r$	$C_{0r}$		Grease lub.	Oil lub.	
5	5	10	10	0.2	NK5/10TN	2.18	1.71	0.260	31 000	47 000	0.004
	5	10	12	0.2	NK5/12TN	3.04	2.63	0.400	31 000	47 000	0.004
6	6	12	10	0.2	NK6/10	3.19	2.90	0.420	29 000	44 000	0.005
	6	12	12	0.2	NK6/12TN	3.07	2.74	0.420	29 000	44 000	0.006
7	7	14	10	0.3	NK7/10TN	2.74	2.44	0.370	28 000	42 000	0.007
	7	14	12	0.3	NK7/12TN	3.40	3.22	0.490	28 000	42 000	0.009
8	8	15	12	0.3	NK8/12	4.57	4.89	0.740	26 000	41 000	0.011
	8	15	12	0.3	NK8/12ASR1	4.57	4.89	0.740	26 000	41 000	0.011
	8	15	16	0.3	NK8/16	5.22	5.78	0.880	26 000	41 000	0.013
9	9	16	12	0.3	NK9/12	4.27	4.60	0.700	26 000	40 000	0.012
	9	16	16	0.3	NK9/16	5.57	6.47	0.980	26 000	40 000	0.015
10	10	17	12	0.3	NK10/12	5.40	6.43	0.980	25 000	39 000	0.013
	10	17	16	0.3	NK10/16TN	5.30	6.27	0.940	25 000	39 000	0.015
12	12	19	12	0.3	NK12/12	6.86	7.60	1.15	19 000	30 000	0.013
	12	19	16	0.3	NK12/16	6.78	9.03	1.40	24 000	37 000	0.018
14	14	22	13	0.3	RNA4900	9.39	10.3	1.55	16 000	24 000	0.018
	14	22	16	0.3	NK14/16	12.4	14.8	2.25	16 000	24 000	0.023
	14	22	20	0.3	NK14/20	14.7	18.4	2.90	16 000	24 000	0.028
15	15	23	16	0.3	NK15/16	12.4	15.0	2.30	15 000	24 000	0.024
	15	23	20	0.3	NK15/20	14.7	18.6	2.95	15 000	24 000	0.031
16	16	24	13	0.3	RNA4901	10.5	12.3	1.85	18 000	28 000	0.020
	16	24	16	0.3	NK16/16	15.4	20.2	2.50	18 000	28 000	0.025
	16	24	20	0.3	NK16/20	16.1	21.3	3.20	18 000	28 000	0.036
	16	24	22	0.3	RNA6901	16.1	21.3	3.30	18 000	28 000	0.036
17	17	25	16	0.3	NK17/16	13.6	17.5	2.70	17 000	27 000	0.027

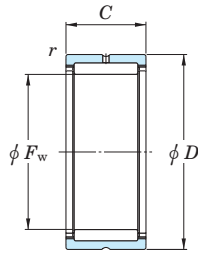
Shaft dia.	Boundary dimensions (mm)				Bearing No.	Basic load ratings (kN)		Fatigue load limit (kN) $C_u$	Limiting speeds (min <sup>-1</sup> )		(Refer.) Mass (kg)
	$F_w$	$D$	$C$	$r_{min.}$		$C_r$	$C_{0r}$		Grease lub.	Oil lub.	
17	17	25	20	0.3	NK17/20	15.4	20.4	3.25	17 000	27 000	0.034
18	18	26	16	0.3	NK18/16	13.6	17.7	2.70	16 000	25 000	0.028
	18	26	20	0.3	NK18/20	16.1	22.0	3.50	16 000	25 000	0.035
19	19	27	16	0.3	NK19/16	14.1	19.0	2.90	15 000	24 000	0.029
	19	27	20	0.3	NK19/20	18.8	23.6	3.75	15 000	24 000	0.037
	19	30	16	0.3	NKS18	15.9	16.2	2.45	17 000	26 000	0.045
20	20	28	13	0.3	RNA4902	11.8	15.3	2.35	14 000	22 000	0.023
	20	28	16	0.3	NK20/16	14.1	19.1	2.90	14 000	22 000	0.030
	20	28	20	0.3	NK20/20	17.5	25.3	4.00	14 000	22 000	0.038
	20	28	23	0.3	RNA6902	18.4	26.9	4.20	14 000	22 000	0.042
20	20	32	20	0.6	NKS20	24.4	26.7	4.30	15 000	24 000	0.058
21	21	29	16	0.3	NK21/16	15.3	21.6	3.30	14 000	21 000	0.032
	21	29	20	0.3	NK21/20	18.1	26.9	4.25	14 000	21 000	0.040
22	22	30	13	0.3	RNA4903	12.2	16.4	2.50	13 000	20 000	0.025
	22	30	16	0.3	NK22/16	15.2	21.7	3.30	13 000	20 000	0.033
	22	30	20	0.3	NK22/20	18.0	27.0	4.30	13 000	20 000	0.041
	22	30	23	0.3	RNA6903	19.8	30.6	4.75	13 000	20 000	0.056
22	22	35	20	0.6	NKS22	22.9	27.1	4.30	14 000	21 000	0.069
24	24	32	16	0.3	NK24/16	16.2	24.3	3.70	12 000	18 000	0.035
	24	32	20	0.3	NK24/20	19.3	30.3	4.80	12 000	18 000	0.045
	24	37	20	0.6	NKS24	29.1	32.8	5.30	13 000	20 000	0.073
25	25	33	16	0.3	NK25/16	16.1	24.4	3.75	11 000	17 000	0.037
	25	33	20	0.3	NK25/20	19.1	30.4	4.80	11 000	17 000	0.047
	25	37	17	0.3	RNA4904	21.3	25.5	3.95	12 000	18 000	0.061
	25	37	30	0.3	RNA6904	36.6	51.0	7.95	12 000	18 000	0.091
	25	38	20	0.6	NKS25	29.1	33.0	5.30	12 000	19 000	0.076

**Heavy-duty needle roller bearings  
without inner rings  
metric series  
NK, NKS, RNA48, RNA49  
RNA69, NKTN series**

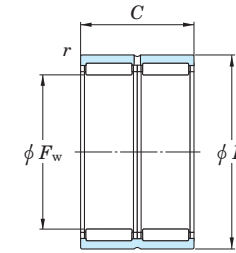
Shaft dia. 26 ~ 37 mm



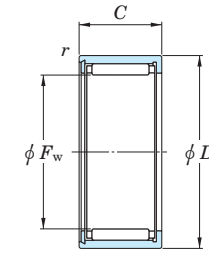
NK ( $\phi F_w \leq 10$ )



NK ( $\phi F_w \geq 12$ ), NKS, RNA48,  
RNA49, RNA69 ( $\phi F_w \leq 35$ )



RNA69  
( $\phi F_w \geq 40$ )



NKTN

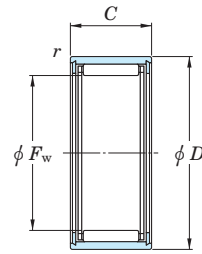
Shaft dia. 38 ~ 52 mm

Shaft dia.	Boundary dimensions (mm)				Bearing No.	Basic load ratings (kN)		Fatigue load limit (kN) $C_u$	Limiting speeds ( $\text{min}^{-1}$ )		(Refer.) Mass (kg)
	$F_w$	$D$	$C$	$r_{\text{min}}$		$C_r$	$C_{0r}$		Grease lub.	Oil lub.	
26	26	34	16	0.3	NK26/16	16.6	25.7	3.95	11 000	17 000	0.039
	26	34	20	0.3	NK26/20	19.7	32.0	5.05	11 000	17 000	0.048
28	28	37	20	0.3	NK28/20	22.6	34.4	5.50	10 000	16 000	0.057
	28	37	30	0.3	NK28/30	29.0	53.8	8.30	10 000	16 000	0.088
	28	39	17	0.3	RNA49/22	23.3	29.6	4.55	10 000	16 000	0.059
	28	39	30	0.3	RNA69/22	30.6	50.7	3.95	10 000	16 000	0.107
	28	42	20	0.6	NKS28	30.3	38.4	6.15	11 000	16 000	0.094
29	29	38	20	0.3	NK29/20	23.4	36.4	5.80	9 800	15 000	0.059
	29	38	30	0.3	NK29/30	29.8	56.4	8.70	9 700	15 000	0.090
30	30	40	20	0.3	NK30/20	24.2	38.3	6.10	9 500	15 000	0.071
	30	40	30	0.3	NK30/30	34.7	61.0	9.45	9 500	15 000	0.107
	30	42	17	0.3	RNA4905	24.3	31.7	4.90	9 700	15 000	0.071
	30	42	30	0.3	RNA6905	39.7	59.6	9.30	9 700	15 000	0.127
	30	45	20	0.6	NKS30	34.3	42.8	6.85	9 900	15 000	0.114
32	32	42	20	0.3	NK32/20	24.8	40.4	6.45	8 800	14 000	0.074
	32	42	30	0.3	NK32/30	35.6	64.3	9.95	8 800	14 000	0.112
	32	45	17	0.3	RNA49/28	25.1	33.8	5.20	9 000	14 000	0.080
	32	45	30	0.3	RNA69/28	43.2	62.5	9.75	9 100	14 000	0.140
	32	47	22	0.6	NKS32	36.0	46.2	7.40	9 200	14 000	0.120
35	35	45	20	0.3	NK35/20	26.1	44.4	7.05	8 000	12 000	0.081
	35	45	30	0.3	NK35/30	37.4	70.6	11.0	8 000	12 000	0.122
	35	47	18	0.3	RNA4906	25.9	36.0	5.55	8 200	13 000	0.081
	35	47	30	0.3	RNA6906	42.6	68.2	10.6	8 200	13 000	0.148
	35	50	22	0.6	NKS35	37.5	49.9	8.00	8 400	13 000	0.130
37	37	47	20	0.3	NK37/20	26.6	46.4	7.40	7 600	12 000	0.084
	37	47	30	0.3	NK37/30	38.2	73.9	11.5	7 600	12 000	0.128
	37	52	22	0.6	NKS37	39.0	53.4	8.55	7 900	12 000	0.134

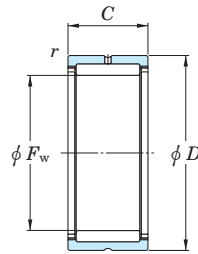
Shaft dia.	Boundary dimensions (mm)				Bearing No.	Basic load ratings (kN)		Fatigue load limit (kN) $C_u$	Limiting speeds ( $\text{min}^{-1}$ )		(Refer.) Mass (kg)
	$F_w$	$D$	$C$	$r_{\text{min}}$		$C_r$	$C_{0r}$		Grease lub.	Oil lub.	
38	38	48	20	0.3	NK38/20	21.7	40.9	6.40	7 300	11 000	0.087
	38	48	30	0.3	NK38/30	31.9	67.0	10.4	7 300	11 000	0.131
40	40	50	20	0.3	NK40/20	27.8	50.4	8.05	7 000	11 000	0.089
	40	50	30	0.3	NK40/30	40.0	80.2	12.4	7 000	11 000	0.137
	40	52	20	0.6	RNA49/32	32.0	49.3	7.85	7 100	11 000	0.100
	40	52	36	0.6	RNA69/32	48.6	84.5	26.1	7 100	11 000	0.185
	40	55	22	0.6	NKS40	40.3	57.0	9.15	7 200	11 000	0.140
42	42	52	20	0.3	NK42/20	28.3	52.4	8.35	6 600	10 000	0.085
	42	52	30	0.3	NK42/30	40.7	83.5	13.0	6 600	10 000	0.141
	42	55	20	0.6	RNA4907	32.8	51.7	8.25	6 700	10 000	0.114
	42	55	36	0.6	RNA6907	49.9	88.7	13.7	6 700	10 000	0.218
43	43	53	20	0.3	NK43/20	29.0	54.4	8.65	6 400	9 900	0.096
	43	53	30	0.3	NK43/30	41.6	86.6	13.4	6 400	9 900	0.134
	43	58	22	0.6	NKS43	41.6	60.7	9.75	6 700	10 000	0.150
45	45	55	20	0.3	NK45/20	29.5	56.4	9.00	6 100	9 400	0.100
	45	55	30	0.3	NK45/30	42.3	89.8	13.9	6 100	9 400	0.151
	45	60	22	0.6	NKS45	43.0	64.2	10.3	6 400	9 800	0.156
47	47	57	20	0.3	NK47/20	30.0	58.5	9.30	5 900	9 000	0.104
	47	57	30	0.3	NK47/30	43.0	93.1	14.4	5 900	9 000	0.158
48	48	62	22	0.6	RNA4908	44.2	67.8	10.9	5 900	9 100	0.154
	48	62	40	0.6	RNA6908	70.8	124	19.8	5 900	9 100	0.300
50	50	62	25	0.3	NK50/25	40.7	79.3	12.5	5 500	8 500	0.171
	50	62	35	0.6	NK50/35	55.0	117	18.2	5 500	8 500	0.242
	50	65	22	1	NKS50	45.5	71.3	11.4	5 700	8 700	0.170
52	52	68	22	0.6	RNA4909	46.8	74.8	12.0	5 400	8 400	0.201
	52	68	40	0.6	RNA6909	74.7	137	21.7	5 400	8 400	0.392

**Heavy-duty needle roller bearings  
without inner rings  
metric series  
NK, NKS, RNA48, RNA49  
RNA69, NKTN series**

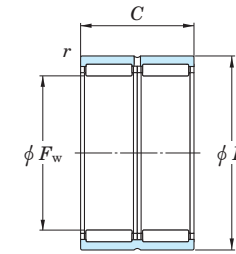
Shaft dia. 55 ~ (75) mm



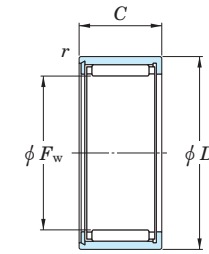
NK ( $\phi F_w \leq 10$ )



NK ( $\phi F_w \geq 12$ ), NKS, RNA48,  
RNA49, RNA69 ( $\phi F_w \leq 35$ )



RNA69  
( $\phi F_w \geq 40$ )



NKTN

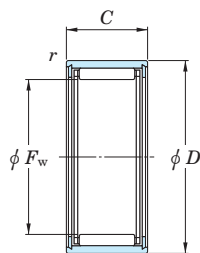
Shaft dia. (75) ~ 110 mm

Shaft dia.	Boundary dimensions (mm)				Bearing No.	Basic load ratings (kN)		Fatigue load limit (kN) $C_u$	Limiting speeds (min <sup>-1</sup> )		(Refer.) Mass (kg)
	$F_w$	$D$	$C$	$r_{min.}$		$C_r$	$C_{0r}$		Grease lub.	Oil lub.	
55	55	68	25	0.6	NK55/25	46.1	87.3	13.9	5 000	7 800	0.207
	55	68	35	0.6	NK55/35	62.3	129	20.0	5 000	7 800	0.293
	55	72	22	1	NKS55	47.9	78.4	12.6	5 100	7 900	0.225
58	58	72	22	0.6	RNA4910	48.9	82.0	13.2	4 800	7 400	0.179
	58	72	40	0.6	RNA6910	75.7	144	22.8	4 800	7 400	0.364
60	60	72	25	0.6	NK60/25	44.3	94.0	14.9	4 400	7 000	0.202
	60	72	35	0.6	NK60/35	59.9	139	21.5	4 400	7 000	0.286
	60	80	28	1.1	NKS60	66.9	103	16.5	4 800	7 300	0.337
63	63	80	25	1	RNA4911	62.0	107	17.1	4 500	6 900	0.285
	63	80	45	1	RNA6911	94.2	172	27.8	4 500	6 900	0.540
65	65	78	25	0.6	NK65/25	48.2	97.7	15.5	4 200	6 500	0.257
	65	78	35	0.6	NK65/35	65.2	144	22.4	4 200	6 500	0.298
	65	85	28	1.1	NKS65	71.0	114	18.3	4 200	6 700	0.362
	65	85	45	1	RNA6912	99.3	189	30.5	4 100	6 300	0.546
68	68	82	25	0.6	NK68/25	49.0	101	16.1	4 000	6 200	0.287
	68	82	35	0.6	NK68/35	66.2	149	23.2	4 000	6 200	0.350
	68	85	25	1	RNA4912	64.8	116	18.6	4 100	6 300	0.304
	68	85	45	1	RNA6912	99.3	189	30.5	4 100	6 300	0.546
70	70	85	25	0.6	NK70/25	43.6	87.9	16.6	3 900	6 000	0.298
	70	85	35	0.6	NK70/35	62.2	139	24.0	3 900	6 000	0.411
	70	90	28	1.1	NKS70	72.6	120	19.3	4 000	6 200	0.383
72	72	90	25	1	RNA4913	66.0	121	19.4	3 900	5 900	0.346
	72	90	45	1	RNA6913	107	213	34.5	3 900	5 900	0.679
73	73	90	25	0.6	NK73/25	61.5	119	19.0	3 800	5 800	0.320
	73	90	35	0.6	NK73/35	82.5	173	27.1	3 800	5 800	0.450
75	75	92	25	0.6	NK75/25	43.7	90.2	19.0	3 600	5 600	0.364
	75	92	35	0.6	NK75/35	60.9	138	27.1	3 600	5 600	0.518

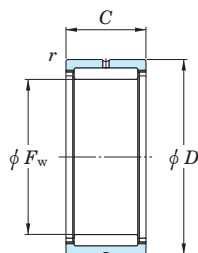
Shaft dia.	Boundary dimensions (mm)				Bearing No.	Basic load ratings (kN)		Fatigue load limit (kN) $C_u$	Limiting speeds (min <sup>-1</sup> )		(Refer.) Mass (kg)	
	$F_w$	$D$	$C$	$r_{min.}$		$C_r$	$C_{0r}$		Grease lub.	Oil lub.		
75	75	95	28	1.1	NKS75	76.5	132	21.1	3 700	5 800	0.413	
80	80	95	25	1	NK80/25	65.0	131	21.0	3 400	5 300	0.331	
	80	95	35	1	NK80/35	79.7	184	28.7	3 400	5 300	0.380	
	80	100	30	1	RNA4914	86.3	157	25.1	3 500	5 400	0.502	
80	80	100	54	1	RNA6914	137	286	45.7	3 500	5 400	0.946	
	85	85	105	25	1	NK85/25	76.4	137	22.2	3 300	5 000	0.506
		85	105	30	1	RNA4915	92.4	175	28.0	3 300	5 000	0.528
85		105	35	1	NK85/35	108	214	34.7	3 300	5 000	0.610	
85	85	105	54	1	RNA6915	143	308	49.3	3 300	5 000	1.020	
	90	90	110	25	1	NK90/25	79.5	147	23.8	3 100	4 700	0.450
		90	110	30	1	RNA4916	91.5	176	28.1	3 100	4 700	0.556
90		110	35	1	NK90/35	113	230	36.1	3 100	4 700	0.745	
90	90	110	54	1	RNA6916	126	320	50.8	3 100	4 700	1.050	
	95	95	115	26	1	NK95/26	49.3	114	24.6	2 800	4 400	0.572
		95	115	36	1	NK95/36	114	238	37.3	2 900	4 500	0.803
100	100	120	26	1	NK100/26	83.6	163	25.8	2 800	4 200	0.530	
	100	120	35	1.1	RNA4917	110	230	36.0	2 800	4 200	0.715	
	100	120	36	1	NK100/36	118	254	39.1	2 800	4 200	0.658	
	100	120	63	1.1	RNA6917	150	416	63.0	2 800	4 200	1.350	
105	105	125	26	1	NK105/26	52.2	127	19.9	2 600	3 900	0.595	
	105	125	35	1.1	RNA4918	114	245	37.8	2 600	4 000	0.746	
	105	125	63	1.1	RNA6918	154	437	66.0	2 600	4 000	1.500	
110	110	130	30	1.1	NK110/30	103	220	33.6	2 500	3 800	0.660	
	110	130	35	1.1	RNA4919	115	253	38.4	2 500	3 800	0.777	
	110	130	40	1.1	NK110/40	132	301	45.7	2 500	3 800	0.900	
	110	130	63	1.1	RNA6919	158	458	68.8	2 500	3 800	1.470	

**Heavy-duty needle roller bearings  
without inner rings  
metric series  
NK, NKS, RNA48, RNA49  
RNA69, NKTN series**

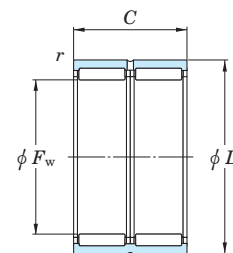
Shaft dia. 115 ~ 175 mm



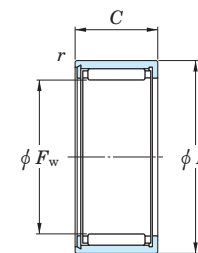
NK ( $\phi F_w \leq 10$ )



NK ( $\phi F_w \geq 12$ ), NKS, RNA48,  
RNA49, RNA69 ( $\phi F_w \leq 35$ )



RNA69  
( $\phi F_w \geq 40$ )



NKTN

Shaft dia.	Boundary dimensions (mm)				Bearing No.	Basic load ratings (kN)		Fatigue load limit (kN) $C_u$	Limiting speeds (min <sup>-1</sup> )		(Refer.) Mass (kg)
	$F_w$	$D$	$C$	$r_{min.}$		$C_r$	$C_{0r}$		Grease lub.	Oil lub.	
115	115	140	40	1.1	RNA4920	139	296	43.9	2 400	3 700	1.220
120	120	140	30	1	RNA4822	90.3	230	33.7	2 300	3 500	0.785
125	125	150	40	1.1	RNA4922	147	325	47.0	2 200	3 400	1.320
130	130	150	30	1	RNA4824	94.1	249	35.7	2 100	3 200	0.850
135	135	165	45	1.1	RNA4924	177	407	58.5	2 000	3 100	1.980
145	145	165	35	1	RNA4826	112	323	44.8	1 900	2 900	1.100
150	150	180	50	1.5	RNA4926	201	495	68.7	1 800	2 800	2.420
155	155	175	35	1.1	RNA4828	116	346	47.1	1 700	2 700	1.170
160	160	190	50	1.5	RNA4928	214	549	74.8	1 700	2 600	2.560
165	165	190	40	1.1	RNA4830	142	402	53.5	1 600	2 500	1.540
175	175	200	40	1.1	RNA4832	146	425	55.6	1 500	2 400	1.910

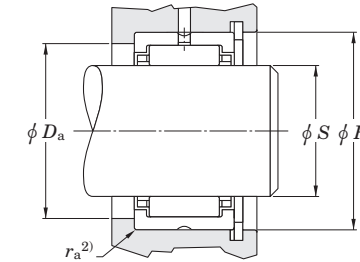
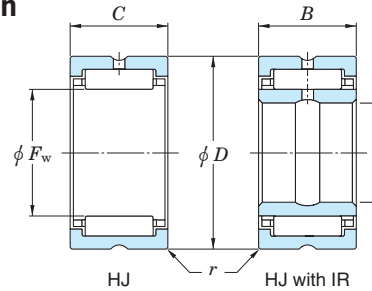


Heavy-duty needle roller bearings

inch series

HJ type

Shaft dia.  $\frac{5}{8} \sim (1 \frac{3}{4})$  in  
(15.875 ~ (44.450) mm)



Shaft surface to be 58 HRC or equivalent

Shaft dia. (in)	Boundary dimensions (mm)				Bearing No.	Used with inner ring No. 1)	Basic load ratings (kN)		Fatigue load limit (kN) $C_u$	Limiting speeds (min <sup>-1</sup> )		(Refer.) Mass (kg)	Recommended dimensions								Shoulder dia. $D_a$ $\pm 0.38$								
	$F_w$	$D$	$C$ (B)	$r$ min.			$C_r$	$C_{0r}$		Grease lub.	Oil lub.		Clearance fit				Tight transition fit												
													S (h6) max.	S (h6) min.	H (H7) max.	H (H7) min.	S (f6) max.	S (f6) min.	H (N7) max.	H (N7) min.									
$\frac{5}{8}$	15.875	28.575	19.050	0.64	HJ-101812	IR-061012	19.3	20.7	3.25	20 000	30 000	0.050	15.875	15.865	28.595	28.575	15.860	15.850	28.567	28.547	23.83								
$\frac{3}{4}$	19.050	31.750	19.050	1.02	HJ-122012	IR-081212	20.7	23.3	3.65	16 000	25 000	0.059	19.050	19.037	31.775	31.750	19.030	19.017	31.742	31.717	26.97								
	19.050	31.750	25.400	1.02									HJ-122016	IR-081216	27.5	33.7	5.30	16 000	25 000	0.077		19.050	19.037	31.775	31.750	19.030	19.017	31.742	31.717
$\frac{7}{8}$	22.225	34.925	19.050	1.02	HJ-142212	IR-101412	23	27.9	4.35	13 000	21 000	0.064	22.225	22.212	34.950	34.925	22.205	22.192	34.917	34.892	30.18								
	22.225	34.925	25.400	1.02									HJ-142216	IR-101416	30.7	40.3	6.35	13 000	21 000	0.086		22.225	22.212	34.950	34.925	22.205	22.192	34.917	34.892
1	25.400	38.100	19.050	1.02	HJ-162412	IR-121612	25.3	32.5	5.10	12 000	18 000	0.073	25.400	25.387	38.125	38.100	25.380	25.367	38.092	38.067	33.32								
	25.400	38.100	25.400	1.02									HJ-162416	IR-121616	33.6	47.2	7.40	12 000	18 000	0.095		25.400	25.387	38.125	38.100	25.380	25.367	38.092	38.067
	25.400	38.100	25.400	1.02									HJ-162416	IR-131616	33.6	47.2	7.40	12 000	18 000	0.095		25.400	25.387	38.125	38.100	25.380	25.367	38.092	38.067
$1 \frac{1}{8}$	28.575	41.275	25.400	1.02	HJ-182616	IR-141816	36.3	53.8	8.45	10 000	16 000	0.104	28.575	28.562	41.300	41.275	28.555	28.542	41.267	41.242	36.53								
	28.575	41.275	25.400	1.02									HJ-182616	IR-151816	36.3	53.8	8.45	10 000	16 000	0.104		28.575	28.562	41.300	41.275	28.555	28.542	41.267	41.242
	28.575	41.275	31.750	1.02									HJ-182620	IR-141820	44.9	70.3	10.9	10 000	16 000	0.132		28.575	28.562	41.300	41.275	28.555	28.542	41.267	41.242
	28.575	41.275	31.750	1.02									HJ-182620	IR-151820	44.9	70.3	10.9	10 000	16 000	0.132		28.575	28.562	41.300	41.275	28.555	28.542	41.267	41.242
$1 \frac{1}{4}$	31.750	44.450	25.400	1.02	HJ-202816	IR-162016	37.4	57.4	9.00	9 100	14 000	0.113	31.750	31.735	44.475	44.450	31.725	31.709	44.442	44.417	39.67								
	31.750	44.450	31.750	1.02									HJ-202820	IR-162020	46.3	75.2	11.7	9 100	14 000	0.145		31.750	31.735	44.475	44.450	31.725	31.709	44.442	44.417
$1 \frac{3}{8}$	34.925	47.625	25.400	1.02	HJ-223016	IR-182216	39.8	64.1	10.1	8 200	13 000	0.127	34.925	34.910	47.650	47.625	34.900	34.884	47.617	47.592	42.88								
	34.925	47.625	31.750	1.02									HJ-223020	IR-182220	49.4	84.1	13.0	8 200	13 000	0.159		34.925	34.910	47.650	47.625	34.900	34.884	47.617	47.592
$1 \frac{1}{2}$	38.100	52.388	25.400	1.52	HJ-243316	IR-202416	47.6	72.5	11.4	7 600	12 000	0.154	38.100	38.085	52.418	52.388	38.075	38.059	52.380	52.349	47.63								
	38.100	52.388	31.750	1.52									HJ-243320	IR-192420	58.7	95.2	14.9	7 600	12 000	0.195		38.100	38.085	52.418	52.388	38.075	38.059	52.380	52.349
	38.100	52.388	31.750	1.52									HJ-243320	IR-202420	58.7	95.2	14.9	7 600	12 000	0.195		38.100	38.085	52.418	52.388	38.075	38.059	52.380	52.349
$1 \frac{5}{8}$	41.275	55.563	25.400	1.52	HJ-263516	IR-212616	48.5	76.5	12.1	7 000	11 000	0.163	41.275	41.260	55.593	55.563	41.250	41.234	55.555	55.524	50.80								
	41.275	55.563	31.750	1.52									HJ-263520	IR-212620	60.1	100.5	15.7	7 000	11 000	0.209		41.275	41.260	55.593	55.563	41.250	41.234	55.555	55.524
	41.275	55.563	31.750	1.52									HJ-263520	IR-222620	60.1	100.5	15.7	7 000	11 000	0.209		41.275	41.260	55.593	55.563	41.250	41.234	55.555	55.524
$1 \frac{3}{4}$	44.450	58.738	25.400	1.52	HJ-283716	IR-232816	49.8	81.0	12.8	6 400	9 900	0.177	44.450	44.435	58.768	58.738	44.425	44.409	58.730	58.699	53.98								
	44.450	58.738	25.400	1.52									HJ-283716	IR-242816	49.8	81.0	12.8	6 400	9 900	0.177		44.450	44.435	58.768	58.738	44.425	44.409	58.730	58.699
	44.450	58.738	31.750	1.52									HJ-283720	IR-222820	61.8	106	16.6	6 400	9 900	0.222		44.450	44.435	58.768	58.738	44.425	44.409	58.730	58.699

[Notes] 1) See pages B470 to B472 for inch series inner rings. Order inner rings separately.

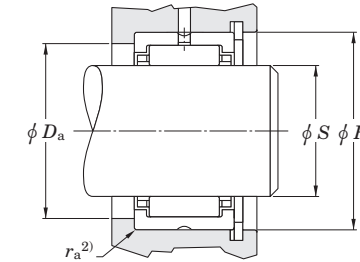
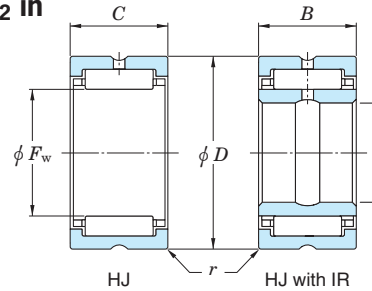
2)  $r_{a \max}$  is equal to the minimum bearing chamfer ( $r_{\min}$ ) at unmarked end.

Heavy-duty needle roller bearings

inch series

HJ type

Shaft dia. (1 3/4) ~ 3 1/2 in  
((44.450) ~ 88.900 mm)



Shaft surface to be 58 HRC or equivalent

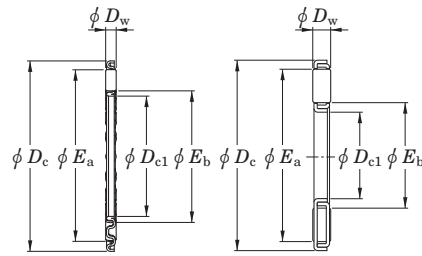
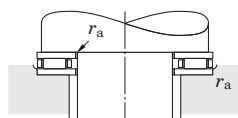
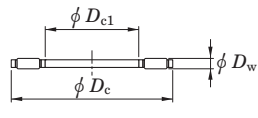
Shaft dia. (in)	Boundary dimensions (mm)				Bearing No.	Used with inner ring No. 1)	Basic load ratings (kN)		Fatigue load limit (kN) Cu	Limiting speeds (min <sup>-1</sup> )		(Refer.) Mass (kg)	Recommended dimensions								Shoulder dia. Da ±0.38
	Fw	D	C (B)	r min.			Cr	C0r		Grease lub.	Oil lub.		Clearance fit				Tight transition fit				
													S (h6) max.	S (h6) min.	H (H7) max.	H (H7) min.	S (f6) max.	S (f6) min.	H (N7) max.	H (N7) min.	
1 3/4	44.450	58.738	31.750	1.52	<b>HJ-283720</b>	<b>IR-232820</b>	61.8	106	16.6	6 400	9 900	0.222	44.450	44.435	58.768	58.738	44.425	44.409	58.730	58.699	53.98
	44.450	58.738	31.750	1.52	<b>HJ-283720</b>	<b>IR-253820</b>	61.8	106	16.6	6 400	9 900	0.222	44.450	44.435	58.768	58.738	44.425	44.409	58.730	58.699	53.98
1 7/8	47.625	61.913	31.750	1.52	<b>HJ-303920</b>	<b>IR-253020</b>	65.4	117	18.1	6 000	9 200	0.236	47.625	47.610	61.943	61.913	47.600	47.584	61.905	61.874	57.15
2	50.800	65.088	25.400	1.52	<b>HJ-324116</b>	<b>IR-273216</b>	53.8	93.0	14.7	5 600	8 600	0.200	50.800	50.782	65.118	65.088	50.770	50.752	65.080	65.049	60.33
	50.800	65.088	31.750	1.52	<b>HJ-324120</b>	<b>IR-243220</b>	66.7	122	19.1	5 600	8 600	0.249	50.800	50.782	65.118	65.088	50.770	50.752	65.080	65.049	60.33
	50.800	65.088	31.750	1.52	<b>HJ-324120</b>	<b>IR-253220</b>	66.7	122	19.1	5 600	8 600	0.249	50.800	50.782	65.118	65.088	50.770	50.752	65.080	65.049	60.33
	50.800	65.088	31.750	1.52	<b>HJ-324120</b>	<b>IR-263220</b>	66.7	122	19.1	5 600	8 600	0.249	50.800	50.782	65.118	65.088	50.770	50.752	65.080	65.049	60.33
	50.800	65.088	31.750	1.52	<b>HJ-324120</b>	<b>IR-273220</b>	66.7	122	19.1	5 600	8 600	0.249	50.800	50.782	65.118	65.088	50.770	50.752	65.080	65.049	60.33
2 1/4	57.150	76.200	38.100	1.52	<b>HJ-364824</b>	<b>IR-283624</b>	89.9	164	25.7	5 000	7 600	0.458	57.150	57.132	76.230	76.200	57.120	57.102	76.192	76.162	68.28
	57.150	76.200	44.450	1.52	<b>HJ-364828</b>	<b>IR-283628</b>	104	198	30.8	5 000	7 600	0.531	57.150	57.132	76.230	76.200	57.120	57.102	76.192	76.162	68.28
2 1/2	63.500	82.550	38.100	2.03	<b>HJ-405224</b>	<b>IR-314024</b>	97.0	187	29.4	4 400	6 800	0.499	63.500	63.482	82.586	82.550	63.470	63.452	82.537	82.502	74.63
	63.500	82.550	38.100	2.03	<b>HJ-405224</b>	<b>IR-324024</b>	97.0	187	29.4	4 400	6 800	0.499	63.500	63.482	82.586	82.550	63.470	63.452	82.537	82.502	74.63
	63.500	82.550	44.450	2.03	<b>HJ-405228</b>	<b>IR-314028</b>	97.0	187	35.2	4 400	6 800	0.499	63.500	63.482	82.586	82.550	63.470	63.452	82.537	82.502	74.63
	63.500	82.550	44.450	2.03	<b>HJ-405228</b>	<b>IR-324028</b>	97.0	187	35.2	4 400	6 800	0.499	63.500	63.482	82.586	82.550	63.470	63.452	82.537	82.502	74.63
2 3/4	69.850	88.900	25.400	2.03	<b>HJ-445616</b>	—	67.2	120	19.1	4 000	6 200	0.363	69.850	69.832	88.936	88.900	69.820	69.802	88.887	88.852	80.98
	69.850	88.900	38.100	2.03	<b>HJ-445624</b>	<b>IR-364424</b>	101	203	31.9	4 000	6 200	0.544	69.850	69.832	88.936	88.900	69.820	69.802	88.887	88.852	80.98
	69.850	88.900	44.450	2.03	<b>HJ-445628</b>	<b>IR-354428</b>	117	245	38.2	4 000	6 200	0.635	69.850	69.832	88.936	88.900	69.820	69.802	88.887	88.852	80.98
	69.850	88.900	44.450	2.03	<b>HJ-445628</b>	<b>IR-364428</b>	117	245	38.2	4 000	6 200	0.635	69.850	69.832	88.936	88.900	69.820	69.802	88.887	88.852	80.98
3	76.200	95.250	38.100	2.03	<b>HJ-486024</b>	<b>IR-404824</b>	107	226	35.5	3 700	5 600	0.585	76.200	76.182	95.286	95.250	76.170	76.152	95.237	95.202	87.33
	76.200	95.250	44.450	2.03	<b>HJ-486028</b>	<b>IR-384828</b>	124	273	42.5	3 700	5 600	0.685	76.200	76.182	95.286	95.250	76.170	76.152	95.237	95.202	87.33
	76.200	95.250	44.450	2.03	<b>HJ-486028</b>	<b>IR-404828</b>	124	273	42.5	3 700	5 600	0.685	76.200	76.182	95.286	95.250	76.170	76.152	95.237	95.202	87.33
3 1/4	82.550	107.950	44.450	2.03	<b>HJ-526828</b>	<b>IR-445228</b>	162	305	48.3	3 400	5 300	1.016	82.550	82.527	107.986	107.950	82.514	82.492	107.937	107.902	98.43
	82.550	107.950	50.800	2.03	<b>HJ-526832</b>	<b>IR-445232</b>	184	358	56.2	3 400	5 300	1.161	82.550	82.527	107.986	107.950	82.514	82.492	107.937	107.902	98.43
3 1/2	88.900	114.300	50.800	2.03	<b>HJ-567232</b>	<b>IR-475632</b>	187	375	58.9	3 200	4 900	1.238	88.900	88.877	114.336	114.300	88.864	88.842	114.287	114.252	104.78
	88.900	114.300	50.800	2.03	<b>HJ-567232</b>	<b>IR-485632</b>	187	375	58.9	3 200	4 900	1.238	88.900	88.877	114.336	114.300	88.864	88.842	114.287	114.252	104.78

[Notes] 1) See pages B470 to B472 for inch series inner rings. Order inner rings separately.

2) ra max is equal to the minimum bearing chamfer (r min) at unmarked end.

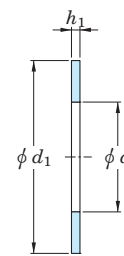
**Needle roller thrust bearings, assemblies, washers**  
**thrust needle roller and cage assemblies, thrust washers**  
**metric series**  
**AXK, FNT series**

Shaft dia. 6 ~ 45 mm

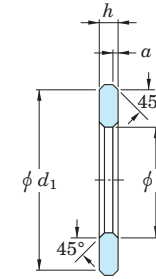


AXK

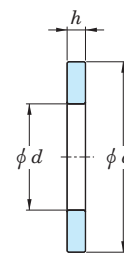
FNT



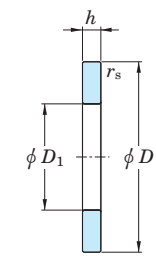
AS  
(h<sub>1</sub> = 1.0)



LS



WS.811

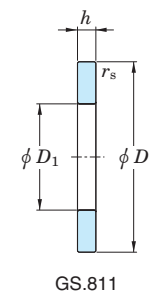
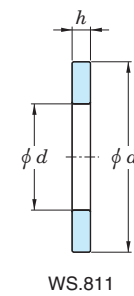
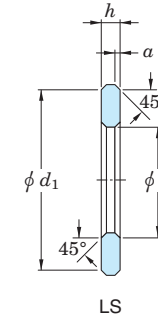
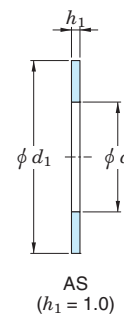
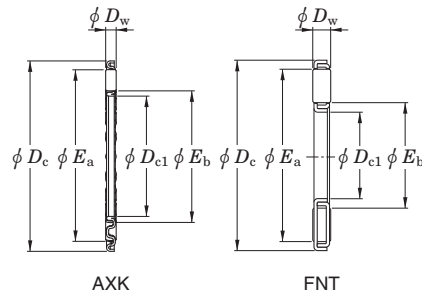
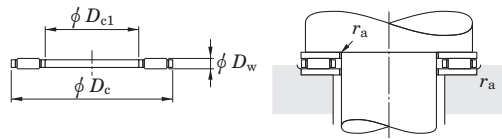


GS.811

Shaft dia.	Boundary dimensions (mm)						Bearing No.	Basic load ratings (kN)		Fatigue load limit (kN) C <sub>u</sub>	Limiting speed (min <sup>-1</sup> ) Oil lub.	(Refer.) Mass (kg)	Washer dimensions (mm)				Thin Washer No.				Heavy (LS) Washer No.				Heavy Washer No.		(Refer.) Mass (kg)
	D <sub>c1</sub>	D <sub>c</sub>	D <sub>w</sub>	E <sub>a</sub>	E <sub>b</sub>	r <sub>a</sub> max.		C <sub>r</sub>	C <sub>0r</sub>				d	D	d <sub>1</sub>	D <sub>1</sub>	h <sub>1</sub> (mm)	Washer No.	(Refer.) Mass (kg)	h (h11) (mm)	a (mm)	Washer No.	(Refer.) Mass (kg)	h (mm)	r min. (mm)	Shaft piloted	
6	6	19	2	16.9	7.8	0.3	AXK0619TN FNT-619	6.37	14.3	1.40	23 000	0.001	6	19	1.00	AS0619	0.001										
				18.0	8.0	0.3		6.82	15.6									1.50	21 000	0.002							
8	8	21	2	18.6	9.6	0.3	AXK0821TN FNT-821	8.34	21.1	2.00	20 000	0.001	8	21	1.00	AS0821	0.002	2.75	0.30	LS0821	0.004						
				20.0	10.0	0.3		7.67	19.1									1.85	20 000	0.002							
10	10	24	2	22.5	11.0	0.3	AXK1024 FNT-1024	9.32	25.9	2.90	17 000	0.003	10	24	1.00	AS1024	0.003	2.75	0.50	LS1024	0.008						
				23.0	12.0	0.3		9.14	25.2									2.40	17 000	0.002							
12	12	26	2	24.5	13.0	0.3	AXK1226 FNT-1226	10.8	32.3	3.40	15 000	0.004	12	26	1.00	AS1226	0.003	2.75	0.50	LS1226	0.009						
				25.0	14.0	0.3		9.92	29.0									2.75	15 000	0.004							
15	15	28	2	27.0	17.0	0.3	AXK1528 FNT-1528	11.1	35.2	3.35	15 000	0.004	15	28	1.00	AS1528	0.003	2.75	0.50	LS1528	0.010	2.75	0.30	WS.81102	GS.81102	0.0100	
				27.0	17.0	0.3		10.2	31.3									3.00	15 000	0.004							
17	17	30	2	28.7	18.3	0.3	AXK1730TN FNT-1730	11.7	38.7	3.70	14 000	0.004	17	30	1.00	AS1730	0.003	2.75	0.50	LS1730	0.011	2.75	0.30	WS.81103	GS.81103	0.011	
				29.0	19.0	0.3		10.8	34.8									3.35	14 000	0.004							
20	20	35	2	34.0	22.0	0.3	AXK2035 FNTA-2035	12.8	45.4	4.40	12 000	0.006	20	35	21	1.00	AS2035	0.005	2.75	0.50	LS2035	0.014	2.75	0.30	WS.81104	GS.81104	0.014
				34.0	22.0	0.3		13.8	50.7										4.80	12 000	0.005						
25	25	42	2	41.0	29.0	0.6	AXK2542 FNT-2542	14.3	56.8	5.50	10 000	0.007	25	42	26	1.00	AS2542	0.007	3.00	1.00	LS2542	0.021	3.00	0.60	WS.81105	GS.81105	0.021
				41.0	27.0	0.6		18.0	75.3										8.05	9 700	0.008						
30	30	47	2	46.0	35.0	0.6	AXK3047 FNTA-3047	16.0	68.1	6.60	9 000	0.009	30	47	32	1.00	AS3047	0.008	3.00	1.00	LS3047	0.023	3.00	0.60	WS.81106	GS.81106	0.023
				46.0	32.0	0.6		18.6	82.4										8.65	8 900	0.009						
35	35	52	2	51.0	40.0	0.6	AXK3552 FNT-3552	17.4	79.5	7.70	8 100	0.010	35	52	37	1.00	AS3552	0.009	3.50	1.00	LS3552	0.030	3.50	0.60	WS.81107	GS.81107	0.032
				51.0	37.0	0.6		21.7	104.0										11.1	7 900	0.010						
40	40	60	3	58.0	45.0	0.6	AXK4060 FNT-4060	27.1	110.0	11.9	7 000	0.016	40	60	42	1.00	AS4060	0.012	3.50	1.00	LS4060	0.041	3.50	0.60	WS.81108	GS.81108	0.043
				57.0	43.0	0.6		31.5	132.0										14.6	7 100	0.020						
45	45	65	3	63.0	50.0	0.6	AXK4565 FNT-4565	29.0	124.0	13.4	6 500	0.020	45	65	47	1.00	AS4565	0.013	4.00	1.00	LS4565	0.052	4.00	0.60	WS.81109	GS.81109	0.054
				63.0	47.0	0.6		37.6	172.0										18.5	6 400	0.024						

**Needle roller thrust bearings, assemblies, washers**  
**thrust needle roller and cage assemblies, thrust washers**  
**metric series**  
**AXK, FNT series**

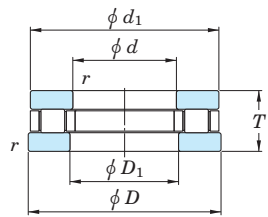
Shaft dia. 50 ~ 160 mm



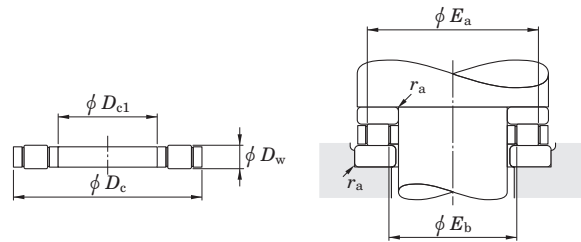
Shaft dia.	Boundary dimensions (mm)						Bearing No.	Basic load ratings (kN)		Fatigue load limit (kN)	Limiting speed (min <sup>-1</sup> )	(Refer.) Mass (kg)	Washer dimensions (mm)			Thin Washer		Heavy (LS)		Heavy Washer No.		(Refer.) Mass (kg)						
	Dc1	Dc	Dw	Ea	Eb	ra max.		Cr	C0r	Cu	Oil lub.		d	D, d1	D1	h1 (mm)	Washer No.	Mass (kg)	h (h11) (mm)	a (mm)	Washer No.		Mass (kg)	h (mm)	r min. (mm)	Shaft piloted	Housing piloted	
50	50	70	3	68.0	55.0	0.6	AXK5070	30.8	137.0	14.9	6 000	0.020	50	70	52	1.00	AS5070	0.014	4.00	1.00	LS5070	0.0560	4.00	0.60	WS.81110	GS.81110	0.059	
				68.0	52.0			19.1	5 900	0.026																		
55	55	78	3	76.0	60.0	0.6	AXK5578	39.4	195.0	20.5	5 300	0.026	55	78	57	1.00	AS5578	0.018	5.00	1.00	LS5578	0.0910	5.00	0.60	WS.81111	GS.81111	0.094	
				76.0	57.0			26.3	5 300	0.033																		
60	60	85	3	83.0	65.0	0.6	AXK6085	44.5	234.0	24.7	4 900	0.035	60	85	62	1.00	AS6085	0.022	4.75	1.50	LS6085	0.102	4.75	1.00	WS.81112	GS.81112	0.106	
65	65	90	3	88.0	70.0	0.6	AXK6590	46.7	254	26.8	4 600	0.036	65	90	67	1.00	AS6590	0.023	5.25	1.50	LS6590	0.121	5.25	1.00	WS.81113	GS.81113	0.125	
70	70	95	4	93.0	74.0	0.6	AXK7095	53.8	253	28.0	4 400	0.055	70	95	72	1.00	AS7095	0.025	5.25	1.50	LS7095	0.1280	5.25	1.00	WS.81114	GS.81114	0.133	
				93.0	73.0			35.3	4 400	0.057																		
75	75	100	4	98.0	79.0	0.6	AXK75100	55.1	266	29.4	4 200	0.058	75	100	77	1.00	AS75100	0.027	5.75	1.50	LS75100	0.1500	5.75	1.00	WS.81115	GS.81115	0.155	
				98.0	78.0			39.7	4 100	0.064																		
80	80	105	4	103.0	84.0	0.6	AXK80105	56.4	279	30.8	4 000	0.092	80	105	82	1.00	AS80105	0.028	5.75	1.50	LS80105	0.1580	5.75	1.00	WS.81116	GS.81116	0.165	
				103.0	83.0			40.1	3 900	0.062																		
85	85	110	4	108.0	89.0	0.6	AXK85110	57.6	291	32.2	3 800	0.063	85	110	87	1.00	AS85110	0.028	5.75	1.50	LS85110	0.166	5.75	1.00	WS.81117	GS.81117	0.173	
90	90	120	4	118.0	94.0	0.6	AXK90120	72.9	405	43.0	3 500	0.081	90	120	92	1.00	AS90120	0.038	6.50	1.50	LS90120	0.245	6.50	1.00	WS.81118	GS.81118	0.253	
100	100	135	4	133.0	105.0	0.6	AXK100135	90.2	552	56.4	3 100	0.106	100	135		1.00	AS100135	0.050										
110	110	145	4	143.0	115.0	0.6	AXK110145	93.2	591	59.0	2 800	0.117	110	145		1.00	AS110145	0.055	7.00	1.50	LS110145	0.373	7.00					
120	120	155	4	153.0	125.0	0.6	AXK120155	98.5	650	63.5	2 700	0.126	120	155		1.00	AS120155	0.059										
130	130	170	5	167.0	136.0	0.6	AXK130170	132	829	78.7	2 400	0.198	130	170		1.00	AS130170	0.074	9.00	1.50	LS130170	0.065						
140	140	180	5	177.0	146.0	0.6	AXK140180	136	887	82.5	2 300	0.221	140	180		1.00	AS140180	0.078										
150	150	190	5	187.0	156.0	0.6	AXK150190	141	944	86.2	2 200	0.225	150	190		1.00	AS150190	0.083										
160	160	200	5	197.0	166.0	0.6	AXK160200	146	1 000	89.9	2 100	0.249	160	200		1.00	AS160200	0.089										

**Needle roller thrust bearings, assemblies, washers**  
**thrust cylindrical roller and cage assemblies, thrust washers**  
**metric series**

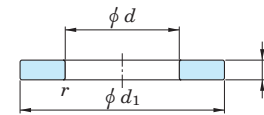
Shaft dia. 15 ~ 55 mm



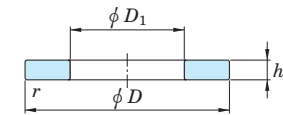
811, 812



K.811, K.812



WS.811, WS.812

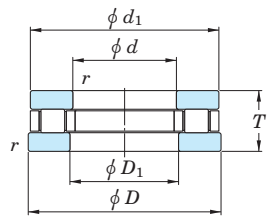


GS.811, GS.812

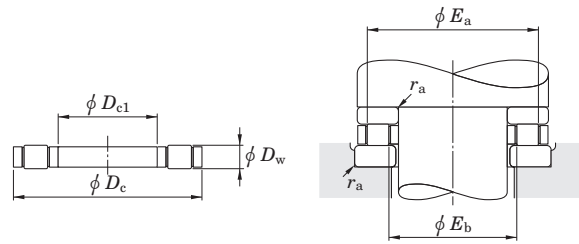
Shaft dia.	Boundary dimensions (mm)							Bearing No.	Basic load ratings (kN)		Fatigue load limit (kN) Cu	Limiting speed (min <sup>-1</sup> ) Oil lub.	(Refer.) Mass (kg)	Washer dimensions (mm)						Washer No.		(Refer.) Mass (kg)			
	Dc1 (E11)	Dc (a13)	Dw	T	Eb max.	Ea min.	ra max.		Ca	C0a				d	D1	D, d1	h max.	h min.	r min.	Shaft piloted	Housing piloted				
15	15	28	3.5	9	18	25	0.3	K.81102LPB K.81102TVP	12.1	26.3	3.70	12 000	0.006	15	16	28	2.75	2.64	0.3	WS.81102 WS.81102	GS.81102 GS.81102	0.010 0.010			
	15	28	3.5	9	18	25	0.3		12.8	28.6				4.05	12 000	0.006	15	16	28				2.75	2.64	0.3
17	17	30	3.5	—	20	27	0.3	K.81103LPB K.81103TVP	12.6	28.6	4.05	11 000	0.008	17	18	30	2.75	2.64	0.3	WS.81103 WS.81103	GS.81103 GS.81103	0.011 0.011			
	17	30	3.5	9	20	27	0.3		14.2	33.4				4.70	11 000	0.008	17	18	30				2.75	2.64	0.3
20	20	35	4.5	10	23	32	0.3	K.81104TVP	23.6	56.8	6.85	9 500	0.009	20	21	35	2.75	2.62	0.3	WS.81104	GS.81104	0.014			
25	25	42	5.0	11	28	39	0.6	K.81105TVP	31.2	81.0	11.4	8 000	0.014	25	26	42	3.00	2.87	0.6	WS.81105	GS.81105	0.021			
30	30	47	5.0	—	33	44	0.6	K.81106LPB K.81106TVP K.81206LPB K.81206TVP	28.5	69.5	10.7	6 700	0.026	30	32	47	3.00	2.87	0.6	WS.81106 WS.81106 WS.81206 WS.81206	GS.81106 GS.81106 GS.81206 GS.81206	0.023 0.023 0.047 0.047			
	30	47	5.0	11	33	44	0.6		33.0	91.1				12.8	6 700	0.016	30	32	47				3.00	2.87	0.6
	30	52	7.5	—	33	49	0.6		53.4	129				13.9	6 300	0.052	30	32	52				4.25	4.12	0.6
	30	52	7.5	16	33	49	0.6		56.9	141				15.2	6 300	0.034	30	32	52				4.25	4.12	0.6
35	35	52	5.0	—	38	49	0.6	K.81107LPB K.81107TVP K.81207LPB K.81207TVP	30.8	86.0	12.1	6 000	0.025	35	37	52	3.50	3.34	0.6	WS.81107 WS.81107 WS.81207 WS.81207	GS.81107 GS.81107 GS.81207 GS.81207	0.032 0.032 0.085 0.085			
	35	52	5.0	12	38	49	0.6		34.8	101				14.2	6 000	0.020	35	37	52				3.50	3.34	0.6
	35	62	7.5	—	41	56	1.0		58.3	152				16.5	5 300	0.073	35	37	62				5.25	5.09	1.0
	35	62	7.5	18	41	56	1.0		61.6	164				17.7	5 300	0.055	35	37	62				5.25	5.09	1.0
40	40	60	6.0	—	44	56	0.6	K.81108LPB K.81108TVP K.81208TVP	44.2	126	12.0	5 300	0.044	40	42	60	3.50	3.34	0.6	WS.81108 WS.81108 WS.81208	GS.81108 GS.81108 GS.81208	0.043 0.043 0.093			
	40	60	6.0	13	44	56	0.6		49.8	148				14.1	5 300	0.031	40	42	60				3.50	3.34	0.6
	40	68	9.0	19	45	63	1.0		86.8	233				26.9	4 800	0.076	40	42	68				5.00	4.84	1.0
45	45	65	6.0	—	49	61	0.6	K.81109LPB K.81109TVP K.81209TVP	47.0	140	13.4	4 800	0.035	45	47	65	4.00	3.84	0.6	WS.81109 WS.81109 WS.81209	GS.81109 GS.81109 GS.81209	0.054 0.054 0.112			
	45	65	6.0	14	49	61	0.6		52.3	163				15.5	4 800	0.035	45	47	65				4.00	3.84	0.6
	45	73	9.0	—	50	68	1.0		94.2	266				30.8	4 500	0.083	45	47	73				5.50	5.34	1.0
50	50	70	6.0	14	54	66	0.6	K.81110LPB K.81110TVP K.81210TVP	49.7	155	14.8	4 300	0.052	50	52	70	4.00	3.84	0.6	WS.81110 WS.81110 WS.81210	GS.81110 GS.81110 GS.81210	0.059 0.059 0.144			
	50	70	6.0	14	54	66	0.6		54.8	177				17.0	4 300	0.042	50	52	70				4.00	3.84	0.6
	50	78	9.0	22	55	73	1.0		101	299				34.6	4 000	0.089	50	52	78				6.5	6.34	1.0
55	55	78	6.0	16	60	73	0.6	K.81111TVP K.81211LPB K.81211TVP	60.3	207	19.8	4 000	0.066	55	57	78	5.00	4.81	0.6	WS.81111 WS.81211 WS.81211	GS.81111 GS.81211 GS.81211	0.094 0.219 0.219			
	55	90	11.0	—	61	84	1.0		127	359				39.6	3 600	0.156	55	57	90				7.00	6.81	1.0
	55	90	11.0	25	61	84	1.0		138	403				45.2	3 600	0.140	55	57	90				7.00	6.81	1.0

**Needle roller thrust bearings, assemblies, washers**  
**thrust cylindrical roller and cage assemblies, thrust washers**  
**metric series**

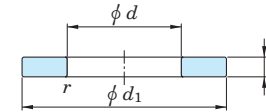
Shaft dia. 60 ~ 90 mm



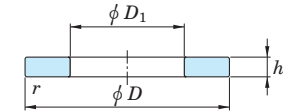
811, 812



K.811, K.812



WS.811, WS.812

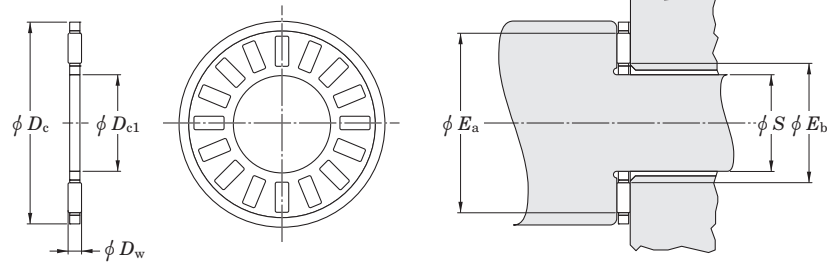


GS.811, GS.812

Shaft dia.	Boundary dimensions (mm)								Bearing No.	Basic load ratings (kN)		Fatigue load limit (kN) $C_u$	Limiting speed (min <sup>-1</sup> ) Oil lub.	(Refer.) Mass (kg)	Washer dimensions (mm)						Washer No.		(Refer.) Mass (kg)
	$D_{c1}$ (E11)	$D_c$ (a13)	$D_w$	$T$	$E_b$ max.	$E_a$ min.	$r_a$ max.	$C_a$		$C_{0a}$	$d$				$D_1$	$D, d_1$	$h$ max.	$h$ min.	$r$ min.	Shaft piloted	Housing piloted		
60	60	85	7.5	17	65	80	1.0	K.81112TVP K.81212LPB	84.4	281	30.4	3 600	0.103	60	62	85	4.75	4.56	1.0	WS.81112 WS.81212	GS.81112 GS.81212	0.106 0.251	
	60	95	11.0	26	66	89	1.0		129	378				42.4	3 400	0.166	60	62	95				7.50
65	65	90	7.5	18	70	85	1.0	K.81113TVP K.81213LPB	88.3	305	33.0	3 400	0.109	65	67	90	5.25	5.06	1.0	WS.81113 WS.81213	GS.81113 GS.81213	0.125 0.285	
	65	100	11.0	27	71	94	1.0		134	403				45.2	3 200	0.176	65	67	100				8.00
70	70	95	7.5	18	75	90	1.0	K.81114TVP K.81214LPB	92.1	328	35.5	3 200	0.056	70	72	95	5.25	5.06	1.0	WS.81114 WS.81214	GS.81114 GS.81214	0.133 0.302	
	70	105	11.0	27	76	99	1.0		138	428				48.0	3 000	0.186	70	72	105				8.00
75	75	100	7.5	19	80	95	1.0	K.81115LPB K.81215LPB	86.1	305	33.0	3 000	0.091	75	77	100	5.75	5.56	1.0	WS.81115 WS.81215	GS.81115 GS.81215	0.155 0.319	
	75	110	11.0	27	81	104	1.0		143	453				50.9	2 800	0.197	75	77	110				8.00
80	80	105	7.5	19	85	100	1.0	K.81116LPB K.81216LPB	87.5	316	34.2	2 800	0.103	80	82	105	5.75	5.56	1.0	WS.81116 WS.81216	GS.81116 GS.81216	0.165 0.357	
	80	115	11.0	28	86	109	1.0		147	478				53.7	2 600	0.208	80	82	115				8.50
85	85	110	7.5	19	90	105	1.0	K.81117LPB K.81217LPB	88.9	328	35.5	2 600	0.108	85	87	110	5.75	5.53	1.0	WS.81117 WS.81217	GS.81117 GS.81217	0.173 0.492	
	85	125	12.0	31	93	117	1.0		174	572				65.5	2 400	0.376	85	88	125				9.50
90	90	120	9.0	22	96	114	1.0	K.81118LPB K.81218LPB	119	432	49.3	2 400	0.156	90	92	120	6.50	6.28	1.0	WS.81118 WS.81218	GS.81118 GS.81218	0.253 0.655	
	90	135	14.0	35	98	127	1.0		215	691				81.5	2 400	0.540	90	93	135				10.50

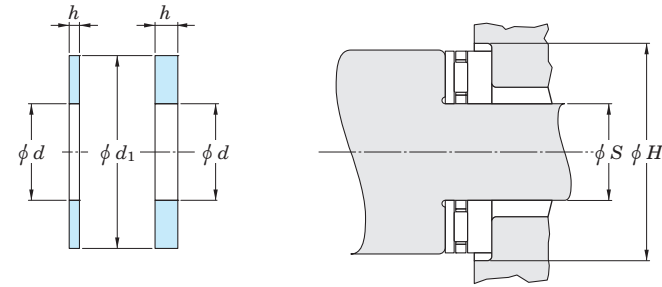
**Needle roller thrust bearings, assemblies, washers**  
**thrust needle roller and cage assemblies, thrust washers**  
**inch series**

Shaft dia.  $1/4 \sim (7/8)$  in (6.35 ~ (22.23) mm)



NTA

Raceway hardness to be 58 HRC or equivalent



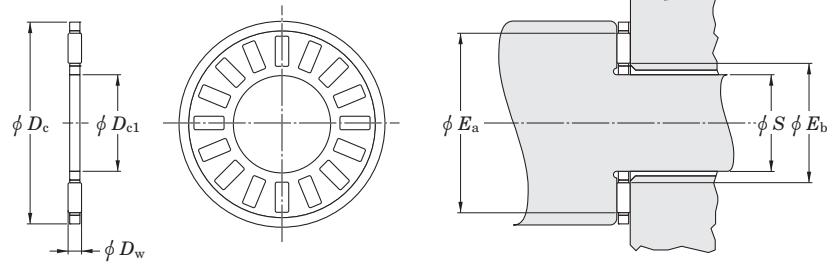
Shaft dia. (in)	Boundary dimensions (mm)					Bearing No.	Basic load ratings (kN)		Fatigue load limit (kN) Cu	Limiting speed <sup>1)</sup> (min <sup>-1</sup> )	(Refer.) Mass (kg)	Washer No.	Washer dimensions (mm)				Piloting dimensions (mm) S		Dia. to clear O.D. (mm) H <sup>2)</sup>	(Refer.) Washer mass (kg)
	Dc1	Dc	Dw	Eb	Ea		Ca	C0a					d	d1	max.	min.	max.	min.		
1/4	6.35	17.45	1.984	8.636	14.732	NTA-411	5.12	10.76	1.05	26 000	0.001	TRA-411	6.35	17.45	0.81	0.76	6.35	6.27	18.26	0.001
												TRB-411	6.35	17.45	1.60	1.52	6.35	6.27	18.26	0.002
												TRC-411	6.35	17.45	2.41	2.34	6.35	6.27	18.26	0.004
5/16	7.92	19.05	1.984	10.16	16.256	NTA-512	5.83	13.17	1.30	24 000	0.002	TRA-512	7.92	19.05	0.81	0.76	7.92	7.85	19.84	0.001
												TRB-512	7.92	19.05	1.60	1.52	7.92	7.85	19.84	0.003
3/8	9.53	20.625	1.984	11.68	18.034	NTA-613	6.05	14.32	1.40	22 000	0.002	TRA-613	9.53	20.62	0.81	0.76	9.53	9.45	21.44	0.001
												TRB-613	9.53	20.62	1.60	1.52	9.53	9.45	21.44	0.003
												TRC-613	9.53	20.62	2.41	2.34	9.53	9.45	21.44	0.004
1/2	12.70	23.80	1.984	14.99	21.08	NTA-815	7.16	19.13	1.85	19 000	0.002	TRA-815	12.70	23.80	0.81	0.76	12.70	12.62	24.61	0.002
												TRB-815	12.70	23.80	1.60	1.52	12.70	12.62	24.61	0.004
												TRC-815	12.70	23.80	2.41	2.34	12.70	12.62	24.61	0.005
9/16	14.275	25.40	1.9837	16.51	22.606	NTA-916	7.70	21.53	2.10	18 000	0.003	TRA-916	14.27	25.40	0.81	0.76	14.27	14.20	26.19	0.002
												TRB-916	14.27	25.40	1.60	1.52	14.27	14.20	26.19	0.004
												TRC-916	14.27	25.40	2.41	2.34	14.27	14.20	26.19	0.006
5/8	15.88	28.575	1.9837	18.03	25.908	NTA-1018	9.79	30.38	2.85	15 000	0.003	TRA-1018	15.88	28.58	0.81	0.76	15.88	15.80	29.36	0.003
												TRB-1018	15.88	28.58	1.60	1.52	15.88	15.80	29.36	0.005
												TRC-1018	15.88	28.58	2.41	2.34	15.88	15.80	29.36	0.008
												TRD-1018	15.88	28.58	3.20	3.12	15.88	15.80	29.36	0.011
												TRE-1018	15.88	28.58	3.99	3.91	15.88	15.80	29.36	0.013
3/4	19.05	31.75	1.9837	21.34	28.956	NTA-1220	10.90	36.48	3.40	14 000	0.004	TRA-1220	19.05	31.75	0.81	0.76	19.05	18.97	32.54	0.003
												TRB-1220	19.05	31.75	1.60	1.52	19.05	18.97	32.54	0.006
												TRC-1220	19.05	31.75	2.41	2.34	19.05	18.97	32.54	0.010
												TRD-1220	19.05	31.75	3.20	3.12	19.05	18.97	32.54	0.012
												TRE-1220	19.05	31.75	3.99	3.91	19.05	18.97	32.54	0.015
7/8	22.23	36.50	1.984	24.38	33.782	NTA-1423	13.43	49.82	4.65	12 000	0.005	TRA-1423	22.23	36.50	0.81	0.76	22.23	22.15	37.31	0.004
												TRB-1423	22.23	36.50	1.60	1.52	22.23	22.15	37.31	0.008

[Notes] 1) Limiting speeds listed are based on adequate oil lubrication.  
 Suggestions for an application requiring O.D. piloting should be determined in consultation with JTEKT.

2) If the shaft and the housing adjacent to the bearing O.D. are not concentric, the T.I.R. between the shaft and housing should be added to this dimension.

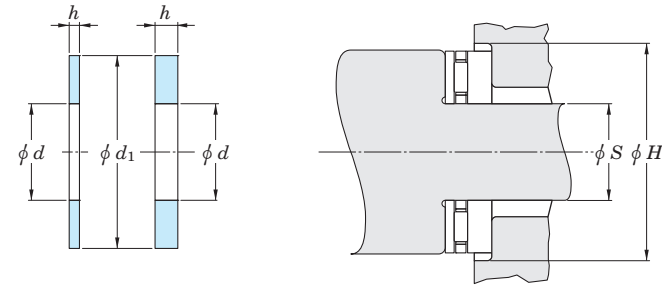
**Needle roller thrust bearings, assemblies, washers**  
**thrust needle roller and cage assemblies, thrust washers**  
**inch series**

Shaft dia. (7/8) ~ (1 1/2) in ((22.23) ~ (38.10) mm)



NTA

Raceway hardness to be 58 HRC or equivalent



Shaft dia. (in)	Boundary dimensions (mm)					Bearing No.	Basic load ratings (kN)		Fatigue load limit (kN) Cu	Limiting speed <sup>1)</sup> (min <sup>-1</sup> )	(Refer.) Mass (kg)	Washer No.	Washer dimensions (mm)				Piloting dimensions (mm) S		Dia. to clear O.D. (mm) H <sup>2)</sup>	(Refer.) Washer mass (kg)				
	Dc1	Dc	Dw	Eb	Ea		Ca	C0a					d	d1	max.	min.	max.	min.						
7/8	22.23	42.85	1.984	25.91	39.878	NTC-1427	18.46	78.29	8.05	9 800	0.008	TRC-1423	22.23	36.50	2.41	2.34	22.23	22.15	37.31	0.012				
												TRD-1423	22.23	36.50	3.20	3.12	22.23	22.15			43.66	0.015		
												TRB-1427	22.23	42.86	1.60	1.52	22.23	22.15						
												TRC-1427	22.23	42.86	2.41	2.34	22.23	22.15					43.66	0.020
												TRD-1427	22.23	42.86	3.20	3.12	22.23	22.15						
1	25.40	39.675	1.984	27.69	36.83	NTA-1625	13.83	53.82	5.00	11 000	0.006	TRA-1625	25.40	39.67	0.81	0.76	25.40	25.32	40.49	0.005				
												TRB-1625	25.40	39.67	1.60	1.52	25.40	25.32			40.49	0.009		
												TRD-1625	25.40	39.67	3.20	3.12	25.40	25.32						
												TRE-1625	25.40	39.67	3.99	3.91	25.40	25.32						
1 1/8	28.58	44.45	1.9837	30.73	41.656	NTA-1828	16.68	71.17	7.30	9 600	0.009	TRA-1828	28.58	44.45	0.81	0.76	28.58	28.50	45.24	0.006				
												TRB-1828	28.58	44.45	1.60	1.52	28.58	28.50			45.24	0.011		
												TRC-1828	28.58	44.45	2.41	2.34	28.58	28.50						
												TRD-1828	28.58	44.45	3.20	3.12	28.58	28.50						
1 1/4	31.75	49.20	1.9837	34.04	46.228	NTA-2031	20.15	93.41	9.55	8 600	0.010	TRA-2031	31.75	49.20	0.81	0.76	31.75	31.67	50.01	0.007				
												TRB-2031	31.75	49.20	1.60	1.52	31.75	31.67			50.01	0.014		
												TRC-2031	31.75	49.20	2.41	2.34	31.75	31.67						
												TRD-2031	31.75	49.20	3.20	3.12	31.75	31.67					50.01	0.026
												TRF-2031	31.75	49.20	4.78	4.70	31.75	31.67						
1 3/8	34.93	52.375	1.9837	37.08	49.53	NTA-2233	21.35	103.20	10.5	8 000	0.010	TRA-2233	34.93	52.37	0.81	0.76	34.93	34.85	53.19	0.007				
												TRB-2233	34.93	52.37	1.60	1.52	34.93	34.85			53.19	0.015		
												TRC-2233	34.93	52.37	2.41	2.34	34.93	34.85						
												TRD-2233	34.93	52.37	3.20	3.12	34.93	34.85					53.19	0.029
												TRE-2233	34.93	52.37	3.99	3.91	34.93	34.85						
												TRF-2233	34.93	52.37	4.78	4.70	34.93	34.85						
1 1/2	38.10	55.55	1.9837	40.39	52.578	NTA-2435	23.22	117.88	12.0	7 600	0.011	TRA-2435	38.10	55.55	0.81	0.76	38.10	38.02	56.36	0.008				
												TRB-2435	38.10	55.55	1.60	1.52	38.10	38.02			56.36	0.015		

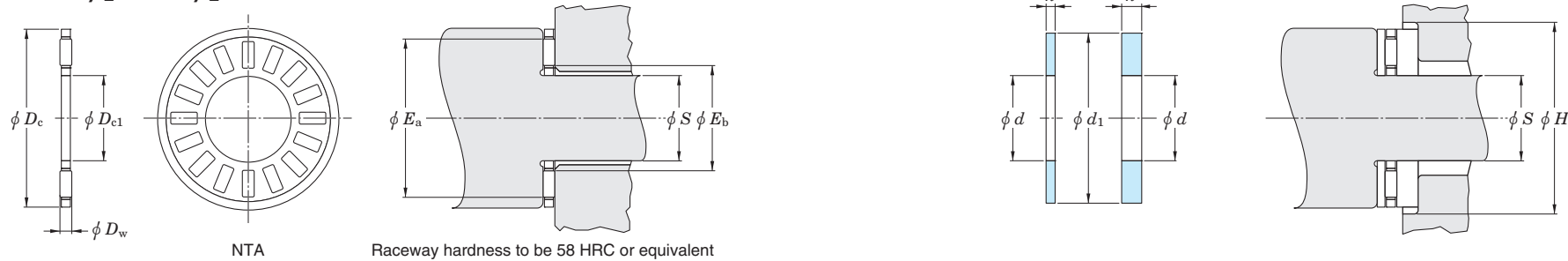
[Notes] 1) Limiting speeds listed are based on adequate oil lubrication. Suggestions for an application requiring O.D. piloting should be determined in consultation with JTEKT.

2) If the shaft and the housing adjacent to the bearing O.D. are not concentric, the T.I.R. between the shaft and housing should be added to this dimension.



**Needle roller thrust bearings, assemblies, washers**  
**thrust needle roller and cage assemblies, thrust washers**  
**inch series**

Shaft dia. (1 1/2) ~ (2 1/2) in ((38.10) ~ (63.50) mm)



NTA

Raceway hardness to be 58 HRC or equivalent

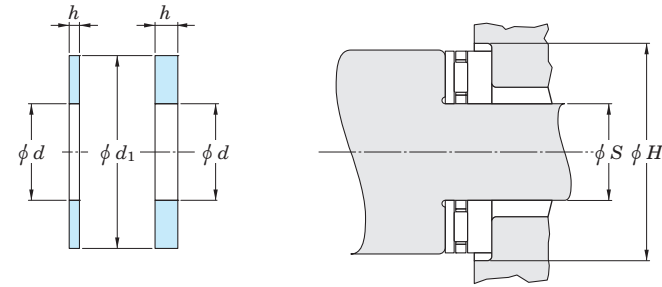
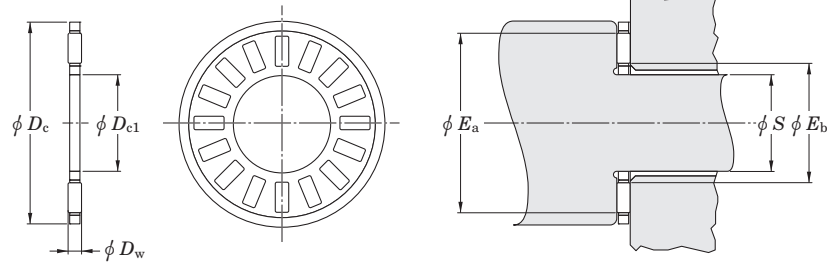
Shaft dia. (in)	Boundary dimensions (mm)					Bearing No.	Basic load ratings (kN)		Fatigue load limit (kN) Cu	Limiting speed <sup>1)</sup> (min <sup>-1</sup> )	(Refer.) Mass (kg)	Washer No.	Washer dimensions (mm)				Piloting dimensions (mm) S		Dia. to clear O.D. (mm) H <sup>2)</sup>	(Refer.) Washer mass (kg)
	Dc1	Dc	Dw	Eb	Ea		Ca	C0a					d	d1	max.	min.	max.	min.		
1 1/2	38.10	55.55	1.9837	40.39	52.578	NTA-2435	23.22	117.88	12.0	7 600	0.011	TRC-2435	38.10	55.55	2.41	2.34	38.10	38.02	56.36	0.023
												TRD-2435	38.10	55.55	3.20	3.12	38.10	38.02	56.36	0.030
												TRF-2435	38.10	55.55	4.78	4.70	38.10	38.02	56.36	0.045
1 3/4	44.45	63.50	1.984	46.74	58.928	NTA-2840	25.31	137.45	14.0	6 800	0.014	TRA-2840	44.45	63.50	0.81	0.76	44.45	44.37	64.29	0.010
												TRB-2840	44.45	63.50	1.60	1.52	44.45	44.37	64.29	0.020
												TRC-2840	44.45	63.50	2.41	2.34	44.45	44.37	64.29	0.029
												TRD-2840	44.45	63.50	3.20	3.12	44.45	44.37	64.29	0.038
												TRF-2840	44.45	63.50	4.78	4.70	44.45	44.37	64.29	0.057
2	50.80	69.85	1.9837	53.09	65.278	NTA-3244	24.02	132.56	13.5	6 100	0.015	TRA-3244	50.80	69.85	0.81	0.76	50.80	50.72	70.64	0.011
												TRB-3244	50.80	69.85	1.60	1.52	50.80	50.72	70.64	0.022
												TRC-3244	50.80	69.85	2.41	2.34	50.80	50.72	70.64	0.033
												TRD-3244	50.80	69.85	3.20	3.12	50.80	50.72	70.64	0.044
												TRF-3244	50.80	69.85	4.78	4.70	50.80	50.72	70.64	0.066
2 1/8	53.98	73.025	1.984	56.39	68.58	NTA-3446	24.42	137.45	14.0	5 800	0.016	TRA-3446	53.98	73.03	0.81	0.76	53.98	53.90	73.81	0.012
												TRB-3446	53.98	73.03	1.60	1.52	53.98	53.90	73.81	0.024
												TRC-3446	53.98	73.03	2.41	2.34	53.98	53.90	73.81	0.035
												TRD-3446	53.98	73.03	3.20	3.12	53.98	53.90	73.81	0.047
2 1/4	57.15	76.20	1.984	59.44	71.628	NTA-3648	24.78	142.34	14.6	5 600	0.017	TRA-3648	57.15	76.20	0.81	0.76	57.15	57.07	76.99	0.012
												TRB-3648	57.15	76.20	1.60	1.52	57.15	57.07	76.99	0.022
												TRC-3648	57.15	76.20	2.41	2.34	57.15	57.07	76.99	0.037
												TRD-3648	57.15	76.20	3.20	3.12	57.15	57.07	76.99	0.048
												TRF-3648	57.15	76.20	4.78	4.70	57.15	57.07	76.99	0.071
2 1/2	57.15	79.375	3.175	59.94	75.184	NTA-3650	37.68	177.04	18.6	5 300	0.029	TRA-3650	57.15	79.38	0.81	0.76	57.15	57.07	76.99	0.012
												TRB-3650	57.15	79.38	1.60	1.52	57.15	57.07	76.99	0.022
2 1/2	63.50	82.55	1.9837	65.79	77.978	NTA-4052	25.53	152.13	15.6	5 100	0.019	TRA-4052	63.50	82.55	0.81	0.76	63.50	63.42	83.34	0.013
												TRB-4052	63.50	82.55	1.60	1.52	63.50	63.42	83.34	0.027
												TRC-4052	63.50	82.55	2.41	2.34	63.50	63.42	83.34	0.041

[Notes] 1) Limiting speeds listed are based on adequate oil lubrication.  
 Suggestions for an application requiring O.D. piloting should be determined in consultation with JTEKT.

2) If the shaft and the housing adjacent to the bearing O.D. are not concentric, the T.I.R. between the shaft and housing should be added to this dimension.

**Needle roller thrust bearings, assemblies, washers**  
**thrust needle roller and cage assemblies, thrust washers**  
**inch series**

Shaft dia. (2 1/2) ~ 4 1/8 in ((63.50) ~ 104.78 mm)



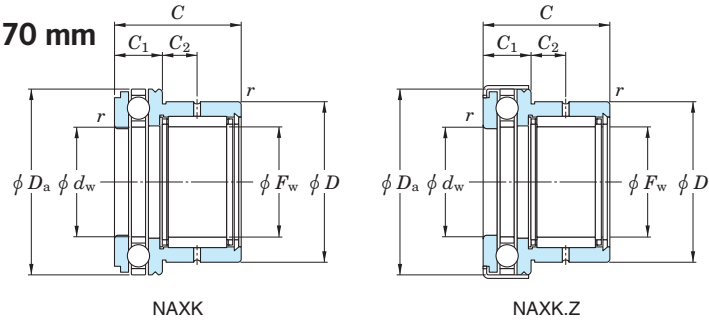
Shaft dia. (in)	Boundary dimensions (mm)					Bearing No.	Basic load ratings (kN)		Fatigue load limit (kN) Cu	Limiting speed <sup>1)</sup> (min <sup>-1</sup> )	(Refer.) Mass (kg)	Washer No.	Washer dimensions (mm)				Piloting dimensions (mm) S		Dia. to clear O.D. (mm) H <sup>2)</sup>	(Refer.) Washer mass (kg)
	Dc1	Dc	Dw	Eb	Ea		Ca	C0a					d	d1	max.	min.	max.	min.		
2 1/2	63.50	82.55	1.9837	65.79	77.978	<b>NTA-4052</b>	25.53	152.13	15.6	5 100	0.019	TRC-4052	63.50	82.55	3.20	3.12	63.50	63.42	83.34	0.054
2 3/4	69.85	92.075	3.175	72.64	87.884	<b>NTA-4458</b>	47.60	255.8	26.8	4 600	0.037	TRA-4458	69.85	92.08	0.81	0.76	69.85	69.77	92.86	0.018
												TRB-4458	69.85	92.08	1.60	1.52	69.85	69.77	92.86	0.035
												TRC-4458	69.85	92.08	2.41	2.34	69.85	69.77	92.86	0.051
												TRD-4458	69.85	92.08	3.20	3.12	69.85	69.77	92.86	0.069
TRF-4458	69.85	92.08	4.78	4.70	69.85	69.77	92.86	0.104												
3	76.20	95.25	1.9837	78.49	90.678	<b>NTA-4860</b>	26.96	172.1	17.6	4 400	0.022	TRA-4860	76.20	95.25	0.81	0.76	76.20	76.12	96.04	0.015
3 1/4	82.55	104.78	3.175	85.34	100.58	<b>NTA-5266</b>	51.60	294.9	30.9	4 000	0.042	TRA-5266	82.55	104.78	0.81	0.76	82.55	82.47	105.56	0.020
												TRB-5266	82.55	104.78	1.60	1.52	82.55	82.47	105.56	0.032
												TRD-5266	82.55	104.78	3.20	3.12	82.55	82.47	105.56	0.061
3 3/4	95.25	117.48	3.175	98.04	113.28	<b>NTA-6074</b>	56.05	344.3	35.5	3 500	0.050	TRA-6074	95.25	117.48	0.81	0.76	95.25	95.17	118.26	0.023
												TRB-6074	95.25	117.48	1.60	1.52	95.25	95.17	118.26	0.046
												TRC-6074	95.25	117.48	2.41	2.34	95.25	95.17	118.26	0.069
												TRD-6074	95.25	117.48	3.20	3.12	95.25	95.17	118.26	0.092
4 1/8	104.78	128.57	3.175	107.44	124.46	<b>NTA-6681</b>	63.61	414.6	41.3	3 200	0.062	TRA-6681	104.78	128.57	0.81	0.76	104.78	104.70	129.39	0.027
												TRC-6681	104.78	128.57	2.41	2.34	104.78	104.70	129.39	0.081
												TRD-6681	104.78	128.57	3.20	3.12	104.78	104.70	129.39	0.109
												TRF-6681	104.78	128.57	4.78	4.70	104.78	104.70	129.39	0.161

[Notes] 1) Limiting speeds listed are based on adequate oil lubrication.  
 Suggestions for an application requiring O.D. piloting should be determined in consultation with JTEKT.

2) If the shaft and the housing adjacent to the bearing O.D. are not concentric, the T.I.R. between the shaft and housing should be added to this dimension.

**Combined needle roller bearings  
ball thrust series  
metric series**

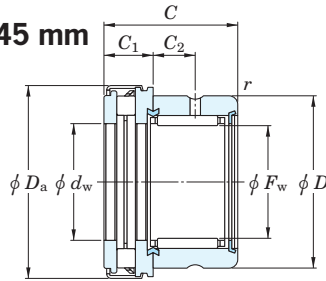
Shaft dia. 10 ~ 70 mm



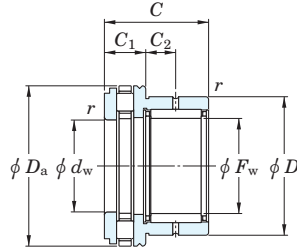
Shaft dia.	Boundary dimensions (mm)								Bearing No.	Limiting speed (min <sup>-1</sup> ) Oil lub.	Basic load ratings (kN)				Fatigue load limits (kN)		(Refer.) Mass (kg)	Matching inner ring No.
	F <sub>w</sub>	D	C	d <sub>w</sub> (E7)	D <sub>a</sub>	C <sub>1</sub>	C <sub>2</sub>	r <sub>min.</sub>			Radial C <sub>r</sub>	Thrust C <sub>0r</sub>	Radial C <sub>u</sub>	Thrust C <sub>0a</sub>				
10	10	19	23	10	24	9	6.5	0.3	NAXK10 NAXK10Z	9 500	7.9	8.7	10.4	14	1.35	0.630	0.04	JR7x10x16
	10	19	23	10	25	9	6.5	0.3		9 500	7.9	8.7	10.4	14	1.35	0.630	0.04	JR7x10x16
12	12	21	23	12	26	9	6.5	0.3	NAXK12 NAXK12Z	9 000	7.5	8.5	10.7	15.4	1.30	0.690	0.046	JR9x12x16
	12	21	23	12	27	9	6.5	0.3		9 000	7.5	8.5	10.7	15.4	1.30	0.690	0.047	JR9x12x16
15	15	24	23	15	28	9	6.5	0.3	NAXK15 NAXK15Z	8 500	9.7	12.6	10.9	16.8	1.90	0.760	0.047	JR12x15x16
	15	24	23	15	29	9	6.5	0.3		8 500	9.7	12.6	10.9	16.8	1.90	0.760	0.05	JR12x15x16
17	17	26	25	17	30	9	8	0.3	NAXK17 NAXK17Z	8 500	11.4	16.1	11.8	19.6	2.50	0.880	0.06	JR14x17x17
	17	26	25	17	31	9	8	0.3		8 500	11.4	16.1	11.8	19.6	2.50	0.880	0.064	JR14x17x17
20	20	30	30	20	35	10	10.5	0.3	NAXK20 NAXK20Z	7 000	14.8	23.7	15.5	26.6	3.65	1.20	0.089	JR17x20x20
	20	30	30	20	36	10	10.5	0.3		7 000	14.8	23.7	15.5	26.6	3.65	1.20	0.094	JR17x20x20
25	25	37	30	25	42	11	9.5	0.6	NAXK25 NAXK25Z	6 300	18.8	29.8	18.8	35.5	4.60	1.60	0.134	JR20x25x20
	25	37	30	25	43	11	9.5	0.6		6 300	18.8	29.8	18.8	35.5	4.60	1.60	0.141	JR20x25x20
30	30	42	30	30	47	11	9.5	0.6	NAXK30 NAXK30Z	5 600	20.2	34.6	19.5	39.9	5.35	2.15	0.146	JR25x30x20
	30	42	30	30	48	11	9.5	0.6		5 600	20.2	34.6	19.5	39.9	5.35	2.15	0.154	JR25x30x20
35	35	47	30	35	52	12	9	0.6	NAXK35 NAXK35Z	5 300	22.1	40.8	20.8	46.6	6.35	2.10	0.176	JR30x35x20
	35	47	30	35	53	12	9	0.6		5 300	22.1	40.8	20.8	46.6	6.35	2.10	0.184	JR30x35x20
40	40	52	32	40	60	13	10	0.6	NAXK40 NAXK40Z	4 500	23.8	47	28	62.9	7.30	2.85	0.224	JR35x40x20
	40	52	32	40	61	13	10	0.6		4 500	23.8	47	28	62.9	7.30	2.85	0.233	JR35x40x20
45	45	58	32	45	65	14	9	0.6	NAXK45 NAXK45Z	4 500	24.9	51.8	29	69.2	8.05	3.10	0.262	JR40x45x20
	45	58	32	45	66.5	14	9	0.6		4 500	24.9	51.8	29	69.2	8.05	3.10	0.275	JR40x45x20
50	50	62	35	50	70	14	10	0.6	NAXK50 NAXK50Z	4 300	30.2	68.5	29.9	75.5	10.7	3.40	0.316	JR45x50x25
	50	62	35	50	71.5	14	10	0.6		4 300	30.2	68.5	29.9	75.5	10.7	3.40	0.332	JR45x50x25
60	60	72	40	60	85	17	12	1	NAXK60	3 600	31.9	78.1	43	113	12.2	5.10	0.48	JR50x60x25
70	70	85	40	70	95	18	11	1	NAXK70	3 400	43.6	87.9	41.6	110	13.9	4.95	0.659	JR60x70x25

**Combined needle roller bearings  
cylindrical roller thrust series  
metric series**

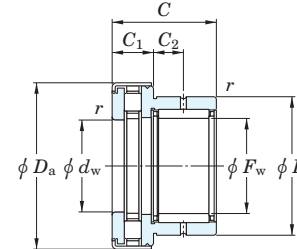
Shaft dia. 10 ~ 45 mm



RAXZ 500



NAXR

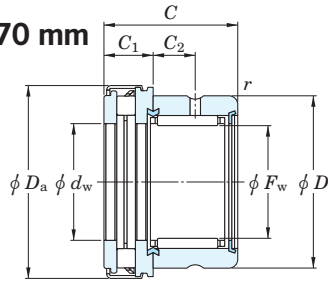


NAXR.Z

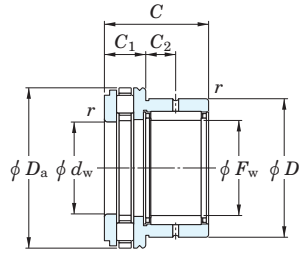
Shaft dia.	Boundary dimensions (mm)								Bearing No.			Limiting speed (min <sup>-1</sup> )	Basic load ratings (kN)				Fatigue load limits (kN)		(Refer.) Mass (kg)	Matching inner ring No.
	F <sub>w</sub>	D	C	d <sub>w</sub> (E7)	D <sub>a</sub>	C <sub>1</sub>	C <sub>2</sub>	r <sub>min.</sub>	RAXZ	NAXR	NAXR.Z		Radial C <sub>r</sub>	Thrust C <sub>0r</sub>	Radial C <sub>u</sub>	Thrust C <sub>0a</sub>	Radial	Thrust		
10	10	19	21.5	10	22.4	7.5	6	0.35	<b>RAXZ 510</b>	—	—	15 500	5.9	7.2	8.2	17.9	1.15	1.85	0.026	IM 7 10 16 P
12	12	21	22	12	26.4	8	6	0.35	<b>RAXZ 512</b>	—	—	13 000	6.8	9.0	12.7	29.5	1.30	3.10	0.033	IM 9 12 16 P
15	15	24	23	15	28	9	6.5	0.3	—	<b>NAXR15</b>	—	12 000	9.7	12.6	12.1	26.3	2.30	3.70	0.032	JR12x15x16
	15	24	23	15	29	9	6.5	0.3	—	—	<b>NAXR15.Z</b>	12 000	9.7	12.6	12.1	26.3	2.30	3.70	0.035	JR12x15x16
	15	24	22	15	28.4	8	6	0.35	<b>RAXZ 515</b>	—	—	11 500	9.7	12.6	14.0	34.0	1.80	3.65	0.036	IM 12 15 16 P
17	17	26	25	17	30	9	8.0	0.3	—	<b>NAXR17</b>	—	11 000	11.4	16.1	12.6	28.6	2.70	4.05	0.050	JR14x17x17
	17	26	25	17	31	9	8.0	0.3	—	—	<b>NAXR17.Z</b>	11 000	11.4	16.1	12.6	28.6	2.70	4.05	0.053	JR14x17x17
	17	26	24	17	30.4	8	8	0.65	<b>RAXZ 517</b>	—	—	10 500	11.8	16.3	15.0	39.0	2.50	4.15	0.044	IM 14 17 17 P
20	20	30	30	20	35	10	10.5	0.3	—	<b>NAXR20TN</b>	—	9 500	14.8	23.7	23.6	56.8	4.00	8.00	0.090	JR17x20x20
	20	30	30	20	36	10	10.5	0.3	—	—	<b>NAXR20Z.TN</b>	9 500	14.8	23.7	23.6	56.8	4.00	8.00	0.095	JR17x20x20
	20	30	29	20	35.4	11	9	0.85	<b>RAXZ 520</b>	—	—	9 000	14.8	23.7	22.0	54.0	3.55	5.55	0.070	IM 15 20 20 P
25	25	37	30	25	42	11	9.5	0.6	—	<b>NAXR25TN</b>	—	8 000	18.8	29.8	31.2	81.0	4.80	11.4	0.146	JR20x25x20
	25	37	30	25	43	11	9.5	0.6	—	—	<b>NAXR25Z.TN</b>	8 000	18.8	29.8	31.2	81.0	4.80	11.4	0.152	JR20x25x20
	25	37	29	25	43	11	9	0.85	<b>RAXZ 525</b>	—	—	7 500	15.1	26.2	25.5	70.0	4.25	7.15	0.105	IM 20 25 20 P
30	30	42	30	30	47	11	9.5	0.6	—	<b>NAXR30TN</b>	—	6 700	20.2	34.6	33.0	91.1	6.10	12.8	0.162	JR25x30x20
	30	42	30	30	48	11	9.5	0.6	—	—	<b>NAXR30Z.TN</b>	6 700	20.2	34.6	33.0	91.1	6.10	12.8	0.169	JR25x30x20
	30	42	29	30	48	11	9	0.85	<b>RAXZ 530</b>	—	—	6 500	20.2	34.6	26.5	77.0	5.25	7.90	0.118	IM 25 30 20 P
35	35	47	30	35	52	12	9.0	0.6	—	<b>NAXR35</b>	—	6 000	22.1	40.8	30.9	86.0	7.05	12.1	0.186	JR30x35x20
	35	47	30	35	53	12	9.0	0.6	—	—	<b>NAXR35.Z</b>	6 000	22.1	40.8	30.9	86.0	7.05	12.1	0.195	JR30x35x20
	35	47	30	35	54	12	9	0.85	<b>RAXZ 535</b>	—	—	5 500	22.1	40.8	33.8	94.0	6.15	8.80	0.146	IM 30 35 20 P
40	40	52	32	40	60	13	10.0	0.6	—	<b>NAXR40</b>	—	5 300	23.8	47.0	44.5	126.0	8.05	12.0	0.288	JR35x40x20
	40	52	32	40	61	13	10.0	0.6	—	—	<b>NAXR40.Z</b>	5 300	23.8	47.0	44.5	126.0	8.05	12.0	0.299	JR35x40x20
	40	52	31	40	61	13	9	0.85	<b>RAXZ 540</b>	—	—	5 000	23.8	47.0	46.0	129.0	7.00	5.95	0.174	IM 35 40 20 P
45	45	58	32	45	65	14	9.0	0.6	—	<b>NAXR45TN</b>	—	4 800	24.9	51.8	47.0	140.0	9.00	15.5	0.360	JR40x45x20
	45	58	32	45	66	14	9.0	0.6	—	—	<b>NAXR45Z.TN</b>	4 800	24.9	51.8	47.0	140.0	9.00	15.5	0.370	JR40x45x20
	45	58	31	45	66	13	9	0.85	<b>RAXZ 545</b>	—	—	4 500	24.9	51.8	49.0	143.0	7.90	6.60	0.206	IM 40 45 20 P

**Combined needle roller bearings  
cylindrical roller thrust series  
metric series**

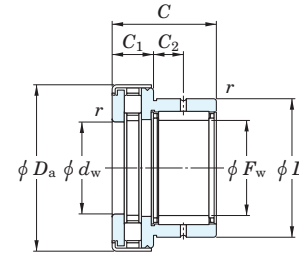
Shaft dia. 50 ~ 70 mm



RAXZ 500



NAXR

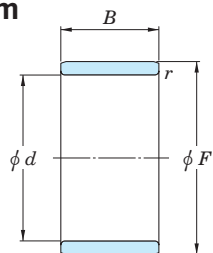


NAXR.Z

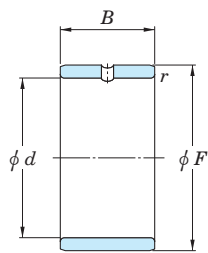
Shaft dia.	Boundary dimensions (mm)								Bearing No.			Limiting speed (min <sup>-1</sup> )	Basic load ratings (kN)				Fatigue load limits (kN)		(Refer.) Mass (kg)	Matching inner ring No.
	F <sub>w</sub>	D	C	d <sub>w</sub> (E7)	D <sub>a</sub>	C <sub>1</sub>	C <sub>2</sub>	r <sub>min.</sub>	RAXZ	NAXR	NAXR.Z		Radial		Thrust		Radial	Thrust		
													C <sub>r</sub>	C <sub>0r</sub>	C <sub>a</sub>	C <sub>0a</sub>				
50	50	62	35	50	70	14	10.0	0.6	—	<b>NAXR50</b>	—	4 300	30.2	68.5	49.7	155.0	12.5	14.8	0.432	JR45x50x25
	50	62	35	50	71	14	10.0	0.6	—	—	<b>NAXR50.Z</b>	4 300	30.2	68.5	49.7	155.0	12.5	14.8	0.452	JR45x50x25
	50	62	34	50	71	13	11	1.3	<b>RAXZ 550</b>	—	—	4 000	30.2	68.5	51.0	157.0	9.60	7.25	0.232	IM 45 50 25 P
60	60	72	36	60	86	15	11	1.3	<b>RAXZ 560</b>	—	—	3 500	31.9	78.1	71.0	255.0	11.5	18.4	0.327	IM 55 60 25 P
70	70	85	36	70	96	15	11	1.3	<b>RAXZ 570</b>	—	—	3 000	36.1	84.7	77.0	295.0	13.3	21.2	0.435	IM 60 70 25 P

Needle roller bearings, accessories  
inner rings  
metric series

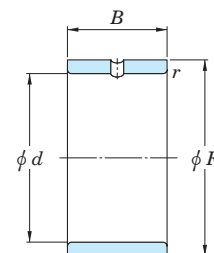
Shaft dia. 5 ~ (10) mm



JR, IM..P



JR.JS1



JRZ.JS1

Shaft dia. (10) ~ (15) mm

Shaft dia.	Boundary dimensions (mm)				Bearing No.	(Refer.) Mass (kg)
	d	F	B	r <sub>min.</sub>		
5	5	8	8	0.3	JR5x8x8JS1	0.002
	5	8	12	0.3	JR5x8x12	0.003
	5	8	16	0.3	JR5x8x16	0.004
6	6	9	8	0.3	JR6x9x8JS1	0.002
	6	9	12	0.3	JR6x9x12	0.003
	6	9	16	0.3	JR6x9x16	0.004
	6	10	10	0.3	JR6x10x10	0.004
	6	10	10	0.3	JR6x10x10JS1	0.004
	6	10	12	0.3	JRZ6x10x12JS1	0.005
	6	10	12	0.3	JR6x10x12JS1	0.005
7	7	10	10.5	0.3	JR7x10x10,5	0.003
	7	10	12	0.3	JR7x10x12	0.004
	7	10	16	0.3	JR7x10x16	0.005
8	8	12	10	0.3	JR8x12x10	0.005
	8	12	10	0.3	JR8x12x10JS1	0.005
	8	12	10.5	0.3	JR8x12x10,5	0.005
	8	12	12	0.3	JRZ8x12x12JS1	0.006
	8	12	12.5	0.3	JR8x12x12,5	0.006
	8	12	16	0.3	IM 8 12 16 P	0.007
	8	12	16	0.3	JR8x12x16	0.007
9	9	12	12	0.3	JR9x12x12	0.005
	9	12	16	0.3	JR9x12x16	0.006
10	10	13	12.5	0.3	JR10x13x12,5	0.005
	10	14	11	0.3	JR10x14x11JS1	0.007
	10	14	12	0.3	JR10x14x12	0.007
	10	14	12	0.3	JR10x14x12JS1	0.007
	10	14	13	0.3	JR10x14x13	0.007
	10	14	14	0.3	JRZ10x14x14JS1	0.008
	10	14	14	0.3	JR10x14x14JS1	0.008
	10	14	16	0.3	JR10x14x16	0.009
	10	14	16	0.3	JR10x14x16JS1	0.009

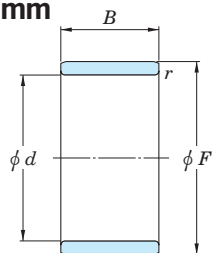
[Note] 1) Please contact JTEKT about outside diameter tolerance.

Shaft dia.	Boundary dimensions (mm)				Bearing No.	(Refer.) Mass (kg)
	d	F	B	r <sub>min.</sub>		
10	10	14	20	0.3	JR10x14x20	0.012
12	12	15	12.5	0.3	JR12x15x12,5	0.006
	12	15	16	0.3	JR12x15x16	0.008
	12	15	16.5	0.3	JR12x15x16,5	0.008
	12	15	18.5	0.3	JR12x15x18,5	0.009
	12	15	22.4	0.2	IM 12 15 22,4 P	0.011
	12	15	22.5	0.3	JR12x15x22,5	0.011
	12	16	12	0.3	JR12x16x12	0.008
	12	16	12	0.3	JR12x16x12JS1	0.008
	12	16	13	0.3	JR12x16x13	0.008
	12	16	14	0.3	JRZ12x16x14JS1	0.010
	12	16	16	0.3	JR12x16x16	0.011
	12	16	20	0.3	JR12x16x20	0.014
12	16	22	0.3	JR12x16x22	0.015	
13	13	18	16	0.35	IM 13 18 16 P	0.015
14	14	17	17	0.3	JR14x17x17	0.009
15	15	18	16.5	0.3	JR15x18x16,5	0.010
	15	19	16	0.3	JR15x19x16	0.013
	15	19	20	0.3	JR15x19x20	0.017
	15	20	12	0.3	JR15x20x12	0.012
	15	20	12	0.3	JR15x20x12JS1	0.012
	15	20	13	0.3	JR15x20x13	0.014
	15	20	14	0.3	JRZ15x20x14JS1	0.015
	15	20	16	0.3	JR15x20x16	0.017
	15	20	20	0.35	IM 15 20 20 P	0.021
	15	20	23	0.3	JR15x20x23	0.025
	15	20	23	0.3	JR15x20x23JS1	0.025

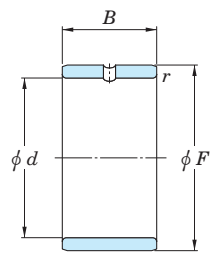
[Note] 1) Please contact JTEKT about outside diameter tolerance.

Needle roller bearings, accessories  
inner rings  
metric series

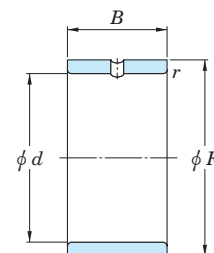
Shaft dia. (15) ~ (20) mm



JR, IM..P



JR.JS1



JRZ.JS1

Shaft dia. (20) ~ (30) mm

Shaft dia.	Boundary dimensions (mm)				Bearing No.	(Refer.) Mass (kg)
	d	F	B	r min.		
15	15	20	26	0.3	JR15x20x26	0.028
17	17	20	16.5	0.3	JR17x20x16,5	0.011
	17	20	20	0.3	JR17x20x20	0.014
	17	20	20.5	0.3	JR17x20x20,5	0.014
	17	20	30.5	0.3	JR17x20x30,5	0.021
	17	21	16	0.3	JR17x21x16	0.015
	17	21	20	0.3	JR17x21x20	0.019
	17	22	13	0.3	JR17x22x13	0.015
	17	22 <sup>1)</sup>	13	0.35	IM 4903	0.015
	17	22	16	0.3	JR17x22x16	0.019
	17	22	16	0.3	JR17x22x16JS1	0.019
	17	22	16	0.3	JRZ17x22x16JS1	0.019
	17	22	20	0.35	IM 17 22 20 P	0.023
	17	22	23	0.3	JR17x22x23	0.028
	17	22	26	0.3	JR17x22x26	0.031
17	22	32	0.3	JR17x22x32	0.038	
20	20	24	16	0.3	JR20x24x16	0.018
	20	24	20	0.3	JR20x24x20	0.022
	20	25	16	0.3	JR20x25x16	0.022
	20	25	16	0.3	JR20x25x16JS1	0.022
	20	25	17	0.3	JR20x25x17	0.023
	20	25	18	0.3	JRZ20x25x18JS1	0.025
	20	25	20	0.3	JR20x25x20	0.028
	20	25	20.5	0.3	JR20x25x20,5	0.029
	20	25	26	0.3	JR20x25x26	0.036
	20	25	26.5	0.3	JR20x25x26,5	0.037
	20	25	30	0.3	JR20x25x30	0.042
	20	25	32	0.3	JR20x25x32	0.044

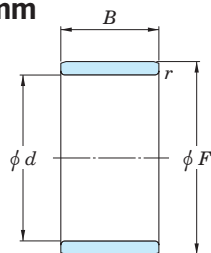
[Note] 1) Please contact JTEKT about outside diameter tolerance.

Shaft dia.	Boundary dimensions (mm)				Bearing No.	(Refer.) Mass (kg)
	d	F	B	r min.		
20	20	25	38.5	0.3	JR20x25x38,5	0.054
22	22	26	16	0.3	JR22x26x16	0.019
	22	26	20	0.3	JR22x26x20	0.023
	22	28	17	0.3	JR22x28x17	0.030
	22	28	20.5	0.3	JR22x28x20,5	0.038
	22	28	30	0.3	JR22x28x30	0.056
23	23	28	20	0.35	IM 23 28 20 P	0.030
25	25	29	20	0.3	JR25x29x20	0.027
	25	29	30	0.3	JR25x29x30	0.040
	25	30	16	0.3	JR25x30x16	0.027
	25	30	16	0.3	JR25x30x16JS1	0.027
	25	30	17	0.3	JR25x30x17	0.028
	25	30	18	0.3	JRZ25x30x18JS1	0.031
	25	30	20	0.3	JR25x30x20	0.034
	25	30	20.5	0.3	JR25x30x20,5	0.035
	25	30	26	0.3	JR25x30x26	0.044
	25	30	26.5	0.3	JR25x30x26,5	0.045
	25	30	30	0.3	JR25x30x30	0.051
	25	30	32	0.3	JR25x30x32	0.054
	25	30	38.5	0.3	JR25x30x38,5	0.066
28	28	32	17	0.3	JR28x32x17	0.028
	28	32	20	0.3	JR28x32x20	0.030
	28	32	30	0.3	JR28x32x30	0.044
30	30	35	16	0.3	JR30x35x16	0.031
	30	35	17	0.3	JR30x35x17	0.033
	30	35 <sup>1)</sup>	17	0.35	IM 4906	0.033

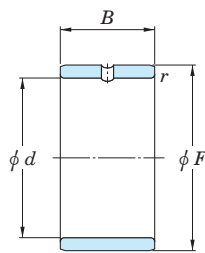
[Note] 1) Please contact JTEKT about outside diameter tolerance.

Needle roller bearings, accessories  
inner rings  
metric series

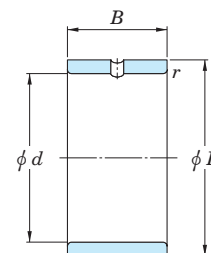
Shaft dia. (30) ~ 38 mm



JR, IM..P



JR.JS1



JRZ.JS1

Shaft dia. 40 ~ 45 mm

Shaft dia.	Boundary dimensions (mm)				Bearing No.	(Refer.) Mass (kg)
	d	F	B	r min.		
30	30	35	18	0.3	JRZ30x35x18JS1	0.036
	30	35	20	0.3	JR30x35x20	0.039
	30	35	20	0.3	JRZ30x35x20JS1	0.039
	30	35	20.5	0.3	JR30x35x20,5	0.040
	30	35	26	0.3	JR30x35x26	0.054
	30	35	30	0.3	JR30x35x30	0.057
	30	35	32	0.3	JR30x35x32	0.062
	30	38	20	0.6	JR30x38x20JS1	0.067
32	32	37	20	0.3	JR32x37x20	0.043
	32	37	30	0.3	JR32x37x30	0.064
	32	40	20	0.6	JR32x40x20	0.069
	32	40	36	0.6	JR32x40x36	0.128
35	35	40	17	0.3	JR35x40x17	0.040
	35	40	20	0.3	JR35x40x20	0.046
	35	40	20.5	0.3	JR35x40x20,5	0.049
	35	40	22	0.3	JR35x40x22	0.052
	35	40	30	0.3	JR35x40x30	0.071
	35	40	34	0.3	JR35x40x34	0.080
	35	40	40	0.3	JR35x40x40	0.094
	35	42	20	0.6	JR35x42x20	0.065
	35	42	20	0.6	JR35x42x20JS1	0.065
	35	42	23	0.6	JRZ35x42x23JS1	0.074
	35	42	36	0.6	JR35x42x36	0.122
35	44	22	0.6	JR35x44x22	0.097	
37	37	42	20	0.35	IM 37 42 20 P	0.046
38	38	43	20	0.3	JR38x43x20	0.050
	38	43	30	0.3	JR38x43x30	0.075

[Note] 1) Please contact JTEKT about outside diameter tolerance.

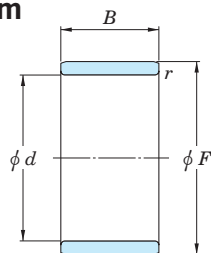
Shaft dia.	Boundary dimensions (mm)				Bearing No.	(Refer.) Mass (kg)
	d	F	B	r min.		
40	40	45	17	0.3	JR40x45x17	0.044
	40	45	20	0.3	JR40x45x20	0.052
	40	45	20.5	0.3	JR40x45x20,5	0.054
	40	45	25	0.35	IM 40 45 25 P	0.062
	40	45	30	0.3	JR40x45x30	0.078
	40	45	34	0.3	JR40x45x34	0.089
	40	45	40	0.3	JR40x45x40	0.115
	40	48	22	0.6	JR40x48x22	0.094
	40	48	23	0.6	JRZ40x48x23JS1	0.100
	40	48	40	0.6	JR40x48x40	0.173
	40	50	20	1	JR40x50x20	0.110
42	42	47	20	0.3	JR42x47x20	0.055
	42	47	30	0.3	JR42x47x30	0.083
45	45	50	20	0.3	JR45x50x20	0.058
	45	50	25	0.6	JR45x50x25	0.073
	45	50	25.5	0.3	JR45x50x25,5	0.075
	45	50	35	0.6	JR45x50x35	0.103
	45	50	40	0.3	JR45x50x40	0.117
	45	52	22	0.6	JR45x52x22	0.090
	45	52 <sup>1)</sup>	22	0.85	IM 4909	0.087
	45	52	23	0.6	JR45x52x23	0.096
	45	52	23	0.6	JRZ45x52x23JS1	0.096
	45	52	40	0.6	JR45x52x40	0.167
	45	55	20	1	JR45x55x20	0.133
45	55	20	1	JR45x55x20JS1	0.133	
45	55	22	1	JR45x55x22	0.135	
45	55	40	1	JR45x55x40	0.247	

[Note] 1) Please contact JTEKT about outside diameter tolerance.

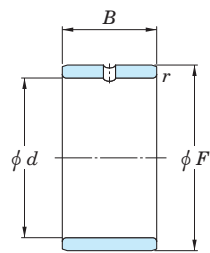


Needle roller bearings, accessories  
inner rings  
metric series

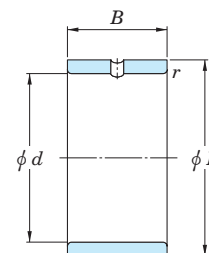
Shaft dia. 50 ~ 60 mm



JR, IM..P



JR.JS1



JRZ.JS1

Shaft dia. 65 ~ (90) mm

Shaft dia.	Boundary dimensions (mm)				Bearing No.	(Refer.) Mass (kg)
	d	F	B	r <sub>min.</sub>		
50	50	55	20	0.3	JR50x55x20	0.065
	50	55	25	0.6	JR50x55x25	0.081
	50	55	35	0.65	IM 50 55 35 P	0.107
	50	55	35	0.6	JR50x55x35	0.113
	50	55	40	0.3	JR50x55x40	0.130
	50	58	22	0.6	JR50x58x22	0.117
	50	58	23	0.6	JRZ50x58x23JS1	0.122
	50	58	40	0.6	JR50x58x40	0.213
	50	60	20	1	JR50x60x20	0.155
	50	60	20	1	JR50x60x20JS1	0.155
	50	60	25	1	JR50x60x25	0.170
	50	60	40	1	JR50x60x40	0.310
	55	55	60	25	0.6	JR55x60x25
55		60	35	0.65	IM 55 60 35 P	0.118
55		60	35	0.6	JR55x60x35	0.124
55		63	25	1	JR55x63x25	0.141
55		63	45	1	JR55x63x45	0.286
55		65	30	1	JR55x65x30	0.222
55		65	60	1	JR55x65x60	0.444
58		65	25	0.85	IM 58 65 25 P	0.125
60	60	68	25	0.6	JR60x68x25	0.153
	60	68	35	0.6	JR60x68x35	0.220
	60	68	45	1	JR60x68x45	0.284
	60	70	25	1	JR60x70x25	0.200
	60	70	30	1	JR60x70x30	0.240
	60	70	35	0.85	IM 60 70 35 P	0.280
	60	70	60	1	JR60x70x60	0.480

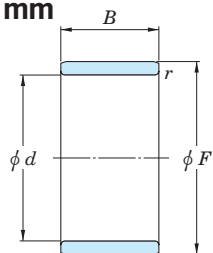
[Note] 1) Please contact JTEKT about outside diameter tolerance.

Shaft dia.	Boundary dimensions (mm)				Bearing No.	(Refer.) Mass (kg)
	d	F	B	r <sub>min.</sub>		
65	65	72	25	1	JR65x72x25	0.143
	65	72	45	1	JR65x72x45	0.266
	65	73	25	0.6	JR65x73x25	0.170
	65	73	35	0.6	JR65x73x35	0.240
	65	75	28	1	JR65x75x28	0.240
	65	75	30	1	JR65x75x30	0.260
	65	75	60	1	JR65x75x60	0.520
70	70	80	25	1	JR70x80x25	0.230
	70	80	30	1	JR70x80x30	0.270
	70	80	35	1	JR70x80x35	0.320
	70	80	54	1	JR70x80x54	0.500
	70	80	60	1	JR70x80x60	0.556
75	75	85	25	1	JR75x85x25	0.240
	75	85	30	1	JR75x85x30	0.289
	75	85	35	1	JR75x85x35	0.338
	75	85	54	1	JR75x85x54	0.530
80	80	90	25	1	JR80x90x25	0.260
	80	90	30	1	JR80x90x30	0.306
	80	90	35	1	JR80x90x35	0.355
	80	90	54	1	JR80x90x54	0.565
85	85	95	26	1	JR85x95x26	0.290
	85	95	30	1	JR85x95x30	0.334
	85	95	36	1	JR85x95x36	0.397
	85	100	35	1.1	JR85x100x35	0.595
85	100	63	1.1	JR85x100x63	1.080	
90	100	26	1	JR90x100x26	0.300	

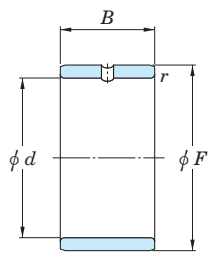
[Note] 1) Please contact JTEKT about outside diameter tolerance.

**Needle roller bearings, accessories**  
**inner rings**  
**metric series**

Shaft dia. (90) ~ 170 mm

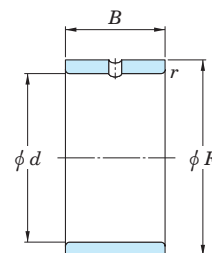


JR, IM..P



JR.JS1

Shaft dia. 180 mm



JRZ.JS1

Shaft dia.	Boundary dimensions (mm)				Bearing No.	(Refer.) Mass (kg)
	d	F	B	r min.		
90	90	100	30	1	JR90x100x30	0.350
	90	100	36	1	JR90x100x36	0.422
	90	105	32	1.1	JR90x105x32	0.580
	90	105	35	1.1	JR90x105x35	0.624
	90	105	63	1.1	JR90x105x63	1.140
95	95	105	26	1	JR95x105x26	0.310
	95	105	36	1	JR95x105x36	0.430
	95	110	35	1.1	JR95x110x35	0.653
	95	110	63	1.1	JR95x110x63	1.200
100	100	110	30	1.1	JR100x110x30	0.384
	100	110	40	1.1	JR100x110x40	0.510
	100	115	40	1.1	JR100x115x40	0.790
110	110	120	30	1	JR110x120x30	0.425
	110	125	40	1.1	JR110x125x40	0.870
120	120	130	30	1	JR120x130x30	0.460
	120	135	45	1.1	JR120x135x45	1.060
130	130	145	35	1.1	JR130x145x35	0.890
	130	150	50	1.5	JR130x150x50	1.730
140	140	155	35	1.1	JR140x155x35	0.955
	140	160	50	1.5	JR140x160x50	1.860
150	150	165	40	1.1	JR150x165x40	1.170
160	160	175	40	1.1	JR160x175x40	1.240
170	170	185	45	1.1	JR170x185x45	1.480

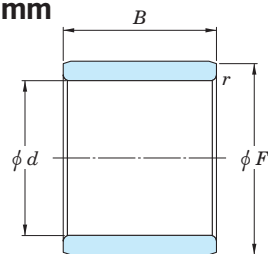
[Note] 1) Please contact JTEKT about outside diameter tolerance.

Shaft dia.	Boundary dimensions (mm)				Bearing No.	(Refer.) Mass (kg)
	d	F	B	r min.		
180	180	195	45	1.1	JR180x195x45	1.560

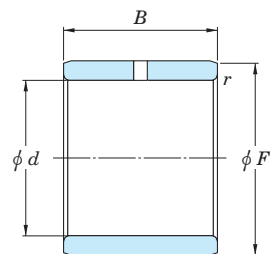
[Note] 1) Please contact JTEKT about outside diameter tolerance.

**Needle roller bearings, accessories**  
**inner rings for machine-tool quality precision-combined bearings**  
**metric series**

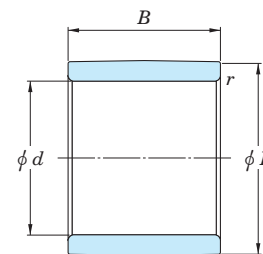
Shaft dia. 17 ~ 45 mm



IM



IMC



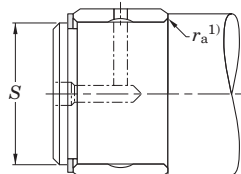
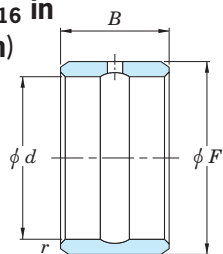
IM...R6

Shaft dia.	Boundary dimensions (mm)				Bearing No.	(Refer.) Mass (kg)
	<i>d</i>	<i>F</i> <sup>1)</sup>	<i>B</i>	<i>r</i> <sub>min.</sub>		
17	17	20	27.5	0.2	IM 19017 IM 20617	0.019
	17	20	32	0.2		0.021
20	20	25	27.5	0.35	IM 19020 IM 20620	0.038
	20	25	32	0.35		0.044
25	25	30	27.5	0.35	IM 19025 IM 20625	0.042
	25	30	32	0.35		0.052
30	30	35	27.5	0.35	IM 19030 IM 20630	0.053
	30	35	32	0.35		0.061
35	35	40	27.5	0.35	IM 19035 IM 20635	0.063
	35	40	32	0.35		0.072
40	40	45	27.5	0.35	IM 19040 IM 20640	0.069
	40	45	32	0.35		0.080
45	45	50	30.5	0.65	IM 19045 IM 20645	0.085
	45	50	35	0.65		0.096

[Note] 1) Please contact JTEKT about outside diameter tolerance.

**Heavy-duty needle roller bearings  
inner rings  
inch series**

Shaft dia.  $\frac{3}{8} \sim 1 \frac{5}{16}$  in  
(9.525 ~ 33.338 mm)



Shaft dia.  $1 \frac{3}{8} \sim (2 \frac{1}{2})$  in  
(34.925 ~ (63.500) mm)

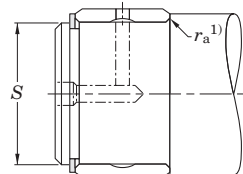
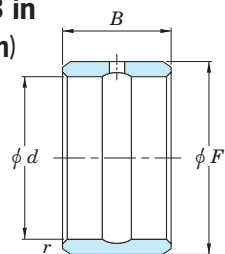
Shaft dia. (in)	Boundary dimensions (mm)				Inner ring No.	(Refer.) Mass (kg)	Shaft dia. (mm)				Used with bearing No.
	d	F	B	r min.			Loose transition fit max.	min.	Interference fit max.	min.	
$\frac{3}{8}$	9.525	15.875	19.05	0.64	<b>IR-061012</b>	0.018	9.520	9.510	9.538	9.530	<b>HJ-101812</b>
$\frac{1}{2}$	12.700	19.050	19.05	1.02	<b>IR-081212</b>	0.023	12.692	12.682	12.715	12.708	<b>HJ-122012</b>
	12.700	19.050	25.40	1.02	<b>IR-081216</b>	0.032	12.692	12.682	12.715	12.708	<b>HJ-122016</b>
$\frac{5}{8}$	15.875	22.225	19.05	1.02	<b>IR-101412</b>	0.027	15.867	15.857	15.890	15.883	<b>HJ-142212</b>
	15.875	22.225	25.40	1.02	<b>IR-101416</b>	0.036	15.867	15.857	15.890	15.883	<b>HJ-142216</b>
$\frac{11}{16}$	17.463	22.225	19.05	1.02	<b>IR-111412</b>	0.023	17.455	17.445	17.478	17.470	<b>HJ-142212</b>
$\frac{3}{4}$	19.050	25.400	19.05	1.02	<b>IR-121612</b>	0.032	19.042	19.030	19.068	19.058	<b>HJ-162412</b>
	19.050	25.400	25.40	1.02	<b>IR-121616</b>	0.041	19.042	19.030	19.068	19.058	<b>HJ-162416</b>
$\frac{13}{16}$	20.638	25.400	25.40	1.02	<b>IR-131616</b>	0.032	20.630	20.617	20.655	20.645	<b>HJ-162416</b>
$\frac{7}{8}$	22.225	28.575	25.40	1.02	<b>IR-141816</b>	0.050	22.217	22.205	22.243	22.233	<b>HJ-182616</b>
	22.225	28.575	31.75	1.02	<b>IR-141820</b>	0.059	22.217	22.205	22.243	22.233	<b>HJ-182620</b>
$\frac{15}{16}$	23.813	28.575	25.40	1.02	<b>IR-151816</b>	0.036	23.805	23.792	23.830	23.820	<b>HJ-182616</b>
	23.813	28.575	31.75	1.02	<b>IR-151820</b>	0.045	23.805	23.792	23.830	23.820	<b>HJ-182620</b>
1	25.400	31.750	25.40	1.02	<b>IR-162016</b>	0.054	25.392	25.380	25.418	25.408	<b>HJ-202816</b>
	25.400	31.750	31.75	1.02	<b>IR-162020</b>	0.068	25.392	25.380	25.418	25.408	<b>HJ-202820</b>
$1 \frac{1}{8}$	28.575	34.925	25.40	1.02	<b>IR-182216</b>	0.059	28.567	28.555	28.593	28.583	<b>HJ-223016</b>
	28.575	34.925	31.75	1.02	<b>IR-182220</b>	0.077	28.567	28.555	28.593	28.583	<b>HJ-223020</b>
$1 \frac{1}{16}$	30.163	38.100	31.75	1.52	<b>IR-192420</b>	0.100	30.155	30.142	30.180	30.170	<b>HJ-243320</b>
$1 \frac{1}{4}$	31.750	38.100	25.40	1.52	<b>IR-202416</b>	0.068	31.740	31.725	31.770	31.760	<b>HJ-243316</b>
	31.750	38.100	31.75	1.52	<b>IR-202420</b>	0.082	31.740	31.725	31.770	31.760	<b>HJ-243320</b>
$1 \frac{5}{16}$	33.338	41.275	25.40	1.52	<b>IR-212616</b>	0.086	33.327	33.312	33.358	33.348	<b>HJ-263516</b>
	33.338	41.275	31.75	1.52	<b>IR-212620</b>	0.109	33.327	33.312	33.358	33.348	<b>HJ-263520</b>

[Note] 1)  $r_{a \max}$  is equal to the minimum bearing chamfer ( $r_{s \min}$ ).

Shaft dia. (in)	Boundary dimensions (mm)				Inner ring No.	(Refer.) Mass (kg)	Shaft dia. (mm)				Used with bearing No.
	d	F	B	r min.			Loose transition fit max.	min.	Interference fit max.	min.	
$1 \frac{3}{8}$	34.925	41.275	31.75	1.52	<b>IR-222620</b>	0.091	34.915	34.900	34.945	34.935	<b>HJ-263520</b>
	34.925	44.450	31.75	1.52	<b>IR-222820</b>	0.141	34.915	34.900	34.945	34.935	<b>HJ-283720</b>
$1 \frac{7}{16}$	36.513	44.450	25.40	1.52	<b>IR-232816</b>	0.095	36.502	36.487	36.533	36.523	<b>HJ-283716</b>
	36.513	44.450	31.75	1.52	<b>IR-232820</b>	0.118	36.502	36.487	36.533	36.523	<b>HJ-283720</b>
$1 \frac{1}{2}$	38.100	44.450	25.40	1.52	<b>IR-242816</b>	0.077	38.090	38.075	38.120	38.110	<b>HJ-283716</b>
	38.100	44.450	31.75	1.52	<b>IR-242820</b>	0.095	38.090	38.075	38.120	38.110	<b>HJ-283720</b>
	38.100	50.800	31.75	1.52	<b>IR-243220</b>	0.209	38.090	38.075	38.120	38.110	<b>HJ-324120</b>
$1 \frac{9}{16}$	39.688	47.625	31.75	1.52	<b>IR-253020</b>	0.127	39.677	39.662	39.708	39.698	<b>HJ-303920</b>
	39.688	50.800	31.75	1.52	<b>IR-253220</b>	0.186	39.677	39.662	39.708	39.698	<b>HJ-324120</b>
$1 \frac{5}{8}$	41.275	50.800	31.75	1.52	<b>IR-263220</b>	0.163	41.265	41.250	41.295	41.285	<b>HJ-324120</b>
$1 \frac{11}{16}$	42.863	50.800	25.40	1.52	<b>IR-273216</b>	0.109	42.852	42.837	42.883	42.873	<b>HJ-324116</b>
	42.863	50.800	31.75	1.52	<b>IR-273220</b>	0.136	42.852	42.837	42.883	42.873	<b>HJ-324120</b>
$1 \frac{3}{4}$	44.450	57.150	38.10	1.52	<b>IR-283624</b>	0.286	44.440	44.425	44.470	44.460	<b>HJ-364824</b>
	44.450	57.150	44.45	1.52	<b>IR-283628</b>	0.336	44.440	44.425	44.470	44.460	<b>HJ-364828</b>
$1 \frac{15}{16}$	49.213	63.500	38.10	2.03	<b>IR-314024</b>	0.358	49.202	49.187	49.233	49.223	<b>HJ-405224</b>
	49.213	63.500	44.45	2.03	<b>IR-314028</b>	0.417	49.202	49.187	49.233	49.223	<b>HJ-405228</b>
2	50.800	63.500	38.10	2.03	<b>IR-324024</b>	0.322	50.790	50.772	50.823	50.810	<b>HJ-405224</b>
	50.800	63.500	44.45	2.03	<b>IR-324028</b>	0.376	50.790	50.772	50.823	50.810	<b>HJ-405228</b>
$2 \frac{3}{16}$	55.563	69.850	44.45	2.03	<b>IR-354428</b>	0.467	55.552	55.535	55.585	55.573	<b>HJ-445628</b>
$2 \frac{1}{4}$	57.150	69.850	38.10	2.03	<b>IR-364424</b>	0.358	57.140	57.122	57.173	57.160	<b>HJ-445624</b>
	57.150	69.850	44.45	2.03	<b>IR-364428</b>	0.417	57.140	57.122	57.173	57.160	<b>HJ-445628</b>
$2 \frac{3}{8}$	60.325	76.200	44.45	2.03	<b>IR-384828</b>	0.562	60.315	60.297	60.348	60.335	<b>HJ-486028</b>
$2 \frac{1}{2}$	63.500	76.200	38.10	2.03	<b>IR-404824</b>	0.395	63.490	63.472	63.523	63.510	<b>HJ-486024</b>

**Heavy-duty needle roller bearings  
inner rings  
inch series**

Shaft dia. (2 1/2) ~ 3 in  
((63.500) ~ 76.200 mm)



Shaft dia. (in)	Boundary dimensions (mm)				Inner ring No.	(Refer.) Mass (kg)	Shaft dia. (mm)				Used with bearing No.
	d	F	B	r min.			Loose transition fit		Interference fit		
							max.	min.	max.	min.	
2 1/2	63.500	76.200	44.45	2.03	<b>IR-404828</b>	0.463	63.490	63.472	63.523	63.510	<b>HJ-486028</b>
2 3/4	69.850	82.550	44.45	2.03	<b>IR-445228</b>	0.503	69.840	69.822	69.873	69.860	<b>HJ-526828</b>
	69.850	82.550	50.80	2.03	<b>IR-445232</b>	0.576	69.840	69.822	69.873	69.860	<b>HJ-526832</b>
2 15/16	74.613	88.900	50.80	2.03	<b>IR-475632</b>	0.694	74.602	74.585	74.635	74.623	<b>HJ-567232</b>
3	76.200	88.900	50.80	2.03	<b>IR-485632</b>	0.621	76.190	76.172	76.223	76.210	<b>HJ-567232</b>

[Note] 1)  $r_{a \max}$  is equal to the minimum bearing chamfer ( $r_{s \min}$ ).

# Miniature one-way clutches

Miniature one-way clutches consist of a case carburizing steel drawn cup, metal or synthetic resin spring, synthetic resin cage and needle rollers.

They are used in clutch mechanisms of various machines. Use in office automation equipment such as copying and facsimile machines is especially common.

- Useful for making equipment smaller and lighter, due to a drawn cup made of thin sheet steel.
- Locking protrusions are provided around the drawn cup, so that creeping can be prevented without having to hold the surface dimensional accuracy precisely.
- Pre-lubricated with optimum grease, so that no lubrication is necessary under normal operating conditions.
- Unit products with a synthetic resin housing are also available. They are compatible with components of various types, such as gears, timing pulleys, cams and rubber rollers. Consult with JTEKT for further information.



1WC series

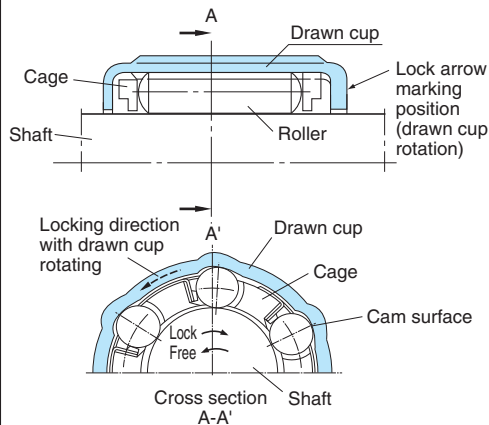


EWC series



Various housings and unit products

## Structure and principles



[When the clutch system works]

When the shaft rotates clockwise as in cross section A-A', rollers are locked while engaged with the drawn cup cam surfaces by the effect of springs (wedging of the shaft by the cam surfaces). The drawn cup is driven as a consequence.

[Clutch idle running]

When the shaft rotates counter-clockwise as in cross section A-A', rollers move away from the drawn cup cam surfaces and rotate freely.

## Miniature one-way clutch types and characteristics

	1WC series (with metal springs)		EWC series (with synthetic resin springs)	
	Heavy load type		Heavy load type	Light load type
	1WC...		EWC...C	EWC...A
Torque capacity	Heavy load		Heavy load	Light load
Operating temperature range	- 10 to + 90°C		- 10 to + 70°C	
Locking life	Locking system can function more than one million. (Note : this estimation is valid as long as torque magnitude does not exceed the torque capacity shown in the specification table.)			
Insert molding	Possible		Impossible	
Delivery of clutch only	Possible			
Unit delivery	Possible			

## Shaft tolerance

	Heavy load type (1WC..., EWC...C)	Light load type (EWC...A)
Shaft tolerance class	h 8	
Surface hardness	50 HRC or harder	30 HRC or harder
Roughness (Ra)	0.3 a or less	0.8 a or less
Roundness and cylindricity	0.005 mm or less	

[Remarks] In some operating conditions, shafts need not be as accurate as shown here.

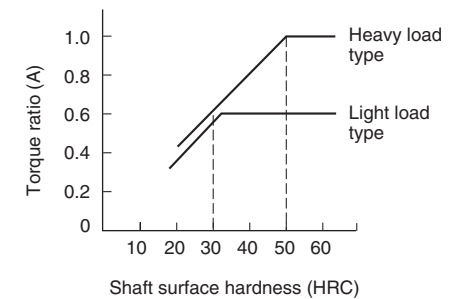
For example :

1. When clutch engaging accuracy is considered unimportant, or when a radial load or moment is not generated, the shaft diameter tolerance can be :
  - shaft diameter 6 mm or less, and EWC0809 (C, A) : 0 to - 0.040 mm
  - shaft diameter 8 mm or more : h 10

2. When the loaded torque is smaller than the torque capacity, shaft surface hardness can be determined as follows :

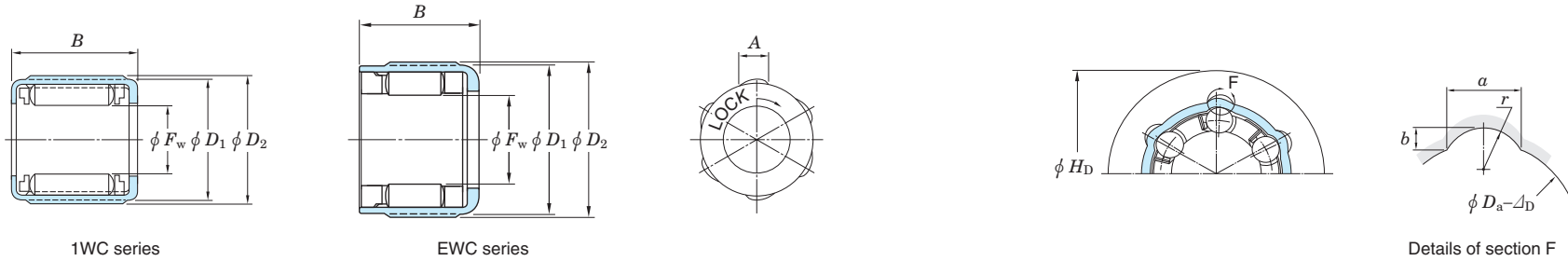
\* The diagram on the right shows approximate shaft surface hardness relative to torque ratio A.

$$\text{Torque ratio (A)} = \frac{\text{Loaded torque}}{\text{Heavy load type torque capacity}}$$



Miniature one-way clutches

$d$  4 ~ 12 mm



Shaft dia. (mm)	Boundary dimensions (mm)					Torque capacity (N·m)	Designations		No. of <sup>1)</sup> outer ring protrusion	Recommended housing dimensions (mm)						(Refer.) Mass (g)	
	$F_w$	$D_1$	$D_2$	$B$	$A$		1WC series (With metal springs)	EWC series (With resin springs)		$H_D$	$a$	$b$	$r$	$D_a$	$\Delta D$ <sup>2)</sup>	1WC	EWC
4	4	8	8.4	6	2.6	0.08	—	EWC0406A	4	12	2.65	0.50	2	8	0.06	—	1.0
	4	8	8.4	6	2.6	0.15	—	EWC0406C	4	12	2.65	0.50	2	8	0.06	—	1.0
6	6	10	10.4	8	2.8	0.25	—	EWC0608A	6	14	2.8	0.57	2	10	0.08	—	1.7
	6	10	10.4	8	2.8	0.44	—	EWC0608C	6	14	2.8	0.57	2	10	0.08	—	1.7
	6	10	10.4	8	2.8	0.44	1WC0608	—	6	14	2.8	0.57	2	10	0.08	2.0	—
	6	10	10.4	12	2.8	0.88	1WC0612	—	6	14	2.8	0.57	2	10	0.08	3.0	—
8	8	12	12.4	9	2.6	0.49	—	EWC0809A	6	16	2.6	0.48	2	12	0.10	—	2.4
	8	12	12.4	9	2.6	0.88	—	EWC0809C	6	16	2.6	0.48	2	12	0.10	—	2.4
	8	14.2	15	12	3.6	1.18	—	EWC0812A	6	18.5	3.6	0.87	2.3	14.2	0.11	—	5.8
	8	14.2	15	12	3.6	1.96	—	EWC0812C	6	18.5	3.6	0.87	2.3	14.2	0.11	—	5.8
	8	14.2	15	12	3.6	1.96	1WC0812	—	6	18.5	3.6	0.87	2.3	14.2	0.11	7.0	—
	8	14.2	15	14.5	3.6	2.65	1WC0815	—	6	18.5	3.6	0.87	2.3	14.2	0.11	8.0	—
	10	16	17	10	5	1.18	—	EWC1010A	6	21	5.0	1.20	3.2	16	0.13	—	6.0
	10	16	17	10	5	1.96	—	EWC1010C	6	21	5.0	1.20	3.2	16	0.13	—	6.0
10	16	17	12	5	1.37	—	EWC1012A	6	21	5.0	1.20	3.2	16	0.13	—	6.8	
10	16	17	12	5	2.35	—	EWC1012C	6	21	5.0	1.20	3.2	16	0.13	—	6.8	
10	16	17	12	5	2.35	1WC1012	—	6	21	5.0	1.20	3.2	16	0.13	8.0	—	
12	18	19	16	5.1	6.28	1WC1216	—	8	23	5.1	1.20	3.3	18	0.14	12	—	

[Notes] 1) Provided at equal intervals.  
2) Recommended interference when polyacetal resin housing is used.

## Ball bearing units

Ball bearing units consist of pre-lubricated sealed ball bearings and a housing which varies in shape.

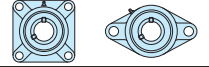
They are capable of aligning themselves efficiently using the spherical fitting surface between the bearing and housing, effectively preventing overloads due to misalignment.



### Pillow block type



### Flanged type



### Flanged type with spigot joint



### Take-up type



### Cartridge type



### Light duty units



### "Compact" series (made from light alloy)



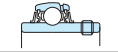
### Stainless-series



### Pressed steel units



### Ball bearings for units



For details, refer to JTEKT separate catalog "Ball bearing units" (CAT. NO. B2007E).

