

Features

Regulated Converters

- 2kV, 4kVDC & 6kVDC Isolation
- Industry Standard 3W DIP24 Package
- Feedback Regulated Output
- Continuous Short Circuit Protection
- Wide Input 2:1 & 4:1
- Medical Approvals (4kV/6kV Versions)
- EN and UL Certificates
- 3 Pinout Options, 3 Case Styles
- Control Pin Option
- Efficiency to 86%

Description

Besides the standard isolation of 2kVDC, this series offers options of 4kVDC (= "/H4") or 6kVDC (= "/H6") making it suitable for medical applications and other sophisticated industrial applications. Packaging can be either DIP-24 plastic or 5-side-shielded DIP24 metal case (=option "/M") as well as SMD pinning (= option "/SMD"). For all the above variants, 2 industry-standard pinouts (= option "/A" or "/C") are available, and B pinning is available with 1.6kVDC isolation. Remote on/off control is possible with the /CTRL option (A pinning only). The converters can deliver 140% rated power for short periods of time to cope with applications with large capacitive loads or high start up currents.

Selection Guide

| Part Number DIP24 (SMD) | Input Voltage (VDC) | Output Voltage (VDC) | Output Current (mA) | Efficiency (%) | Max Capacitive Load ⁽¹⁾ |
|----------------------------|-----------------------------------|----------------------|---------------------|----------------|------------------------------------|
| REC3-xx3.3SRW/H* | 4.5 - 9, 9 - 18, 18 - 36, 36 - 72 | 3.3 | 900 | 66-76 | 4700µF |
| REC3-xx05SRW/H* | 4.5 - 9, 9 - 18, 18 - 36, 36 - 72 | 5 | 600 | 71-79 | 4700µF |
| REC3-xx09SRW/H* | 4.5 - 9, 9 - 18, 18 - 36, 36 - 72 | 9 | 330 | 74-83 | 3300µF |
| REC3-xx12SRW/H* | 4.5 - 9, 9 - 18, 18 - 36, 36 - 72 | 12 | 250 | 75-85 | 2200µF |
| REC3-xx15SRW/H* | 4.5 - 9, 9 - 18, 18 - 36, 36 - 72 | 15 | 200 | 75-86 | 2200µF |
| REC3-xx05DRW/H* | 4.5 - 9, 9 - 18, 18 - 36, 36 - 72 | ±5 | ±300 | 74-83 | ±2200µF |
| REC3-xx12DRW/H* | 4.5 - 9, 9 - 18, 18 - 36, 36 - 72 | ±12 | ±125 | 75-85 | ±1000µF |
| REC3-xx15DRW/H* | 4.5 - 9, 9 - 18, 18 - 36, 36 - 72 | ±15 | ±100 | 75-86 | ±1000µF |
| REC3-xx3.3SRWZ/H* | 9 - 36, 18 - 72 | 3.3 | 900 | 77-79 | 4700µF |
| REC3-xx05SRWZ/H* | 9 - 36, 18 - 72 | 5 | 600 | 78-80 | 4700µF |
| REC3-xx09SRWZ/H* | 9 - 36, 18 - 72 | 9 | 330 | 80-83 | 3300µF |
| REC3-xx12SRWZ/H* | 9 - 36, 18 - 72 | 12 | 250 | 83-85 | 2200µF |
| REC3-xx15SRWZ/H* | 9 - 36, 18 - 72 | 15 | 200 | 83-85 | 2200µF |
| REC3-xx05DRWZ/H* | 9 - 36, 18 - 72 | ±5 | ±300 | 77-80 | ±2200µF |
| REC3-xx12DRWZ/H* | 9 - 36, 18 - 72 | ±12 | ±125 | 83-85 | ±1000µF |
| REC3-xx15DRWZ/H* | 9 - 36, 18 - 72 | ±15 | ±100 | 83-85 | ±1000µF |

H* = H2, H4 or H6 for A or C pinning options with 2kVDC, 4kVDC or 6kVDC isolation.

H* = H for B pinning option with 1.6kVDC isolation only.

2:1 Input
(REC3-S/DRWH4/H6)
xx = 4.5-9Vin = 05
xx = 9-18Vin = 12
xx = 18-36Vin = 24
xx = 36-72Vin = 48

4:1 Input
(REC3-S/DRWZ(H4/H6))
xx = 9-36Vin = 24
xx = 18-72Vin = 48

- * add suffix "/A", "/A/X2", "/B" or "/C" for pinning options, see next page and Isolation Restrictions.
- * add suffix "/M" for metal case.
- * add suffix "/SMD" for SMD package.
- * add suffix "/CTRL" for control pin option (A Pinning only)
- * add suffix -R for Tape and Reel packaging

Ordering Examples:

REC3-0512DRW/H2/A/CTRL = 2:1 input, 5V Vin, ±12V Vout, 2kVDC, pinout "A", plastic case, control pin
 REC3-4812SRWZ/H4/A/M = 4:1 input, 48V Vin, 12V Vout, 4kVDC, pinout "A", metal case, no control pin
 REC3-2412DRWZ/H/B = 4:1 input, 24V Vin, ±12V Vout, 1.6kVDC, pinout "B", plastic case, no control pin
 REC3-0505SRW/H6/C/SMD-R = 2:1 input, 5V Vin, 5V Vout, 6kVDC, SMD pinout "C", plastic case, no control pin, Tape and Reel packaging.

ECONOLINE

DC/DC-Converter

with 3 year Warranty

RECOM

3 Watt DIP24 & SMD Single & Dual Output



EN-60950-1 Certified
UL-60950-1 Certified
EN-60601-1 Certified

REC3-S_DRW

Isolation Restrictions

'B' Pinning is restricted to 1.6kV isolation due to the closeness of the input and output pins.

If the options "/M" for metal case and "/SMD" for SMD pinout are combined, the maximum allowed isolation voltage is 2kVDC because of the shorter distances between pins and the metal case.

DIP-24 through-hole case and SMD-plastic case are not affected and offer the full isolation barriers of 2kV through to 6kVDC.

Refer to Application Notes

Specifications (measured at $T_A = 25^\circ\text{C}$, nominal input voltage, full load and after warm-up)

| | | | |
|---|---|---|------------------------------|
| Input Voltage Range | 2:1 & 4:1 | | |
| Output Voltage Accuracy | $\pm 2\%$ max. | | |
| Line Regulation (HL-LL) | $\pm 0.4\%$ max. | | |
| Load Regulation (for output load current change from 20% to 100%) | $\pm 0.6\%$ max. | | |
| Minimum Load | 10% ⁽²⁾ | | |
| Output Ripple and Noise (0,1 μF capacitor on output, 20MHz BW) | 50mVp-p max. | | |
| Switching Frequency at Full Load and nominal Input Voltage | 2:1 Input types | 90kHz min. / 150kHz max. | |
| | 4:1 Input types | 120kHz min. / 180kHz max. | |
| Input Filter | Pi Network | | |
| Efficiency at Full Load | see above | | |
| No Load Power Consumption | 300mW max. | | |
| Isolation Voltage | H2-Suffix (tested for 1 second) (rated for 1 minute**) | 2000VDC / 1000VAC / 60Hz | |
| Isolation Voltage | H4-Suffix (tested for 1 second) (rated for 1 minute**) | 4000VDC / 2000VAC / 60Hz | |
| Isolation Voltage | H6-Suffix (tested for 1 second) (rated for 1 minute**) | 6000VDC / 3000VAC / 60Hz | |
| Isolation Capacitance | 2:1 Input types | 20pF min. / 60pF max. | |
| | 4:1 Input types | 40pF min. / 80pF max. | |
| Isolation Resistance | 1 G Ω min. | | |
| Short Circuit Protection (Max temp. = 60°C during short circuit conditions) | Continuous, Auto Restart | | |
| Operating Temperature Range (free air convection) | 5V input types | -40°C to +80°C (see Graph) | |
| | others | -40°C to +85°C (see Graph) | |
| Storage Temperature Range | -55°C to +125°C | | |
| Relative Humidity | 95% RH | | |
| Case Material | Non-Conductive Plastic or Metal | | |
| Thermal Impedance | Natural convection | 20°C/W for plastic case 12°C/W for metal case | |
| Package Weight | 13g | | |
| Packing Quantity | 15 pcs per Tube 100 pcs per Reel | | |
| MTBF (+25°C) | } Detailed Information see Application Notes chapter "MTBF" | using MIL-HDBK 217F | 1043 x 10 ³ hours |
| (+85°C) | | using MIL-HDBK 217F | 186 x 10 ³ hours |
| Certifications | UL General Safety Report: E358085 | UL 60950-1 1st Ed. C22.2 No. 60950-1-03 | |
| | EN General Safety Report: SPCLVD1212007 | EN60950-1:2006 + A1:2010+A12:2011 | |
| | EN Medical Safety Report: MDD1205098-3 + RM1205098-3 | IEC/EN 60601-1 3rd Ed. Medical Report + ISO14971 Risk Assessment | |

Derating-Graph (Ambient Temperature)

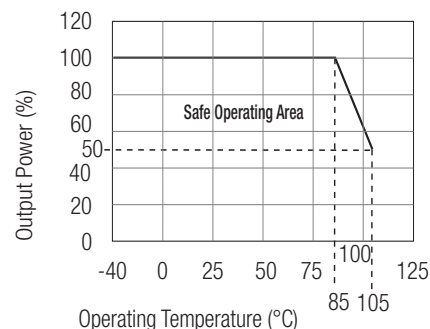
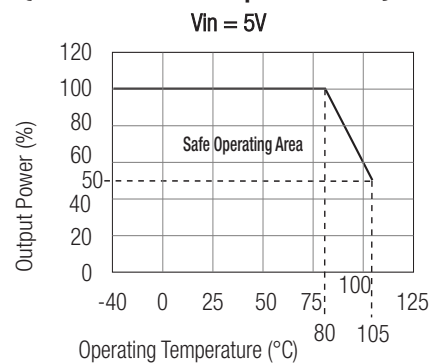

**Any data referred to in this datasheet are of indicative nature and based on our practical experience only. For further details, please refer to our Application Notes.

Notes

- Note 1: Maximum capacitive load is defined as the capacitive load that will allow start up in under 1 second without damage to the converter
- Note 2: The REC3-RW series requires a minimum of 10% load on the output to maintain specified regulation. Operating under no-load conditions will not damage these devices; however, they may not meet all listed specifications.

Typical Characteristics

Single 2:1 Input

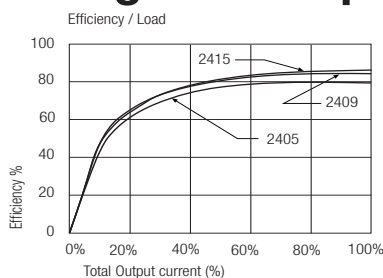

Single 2:1 Input

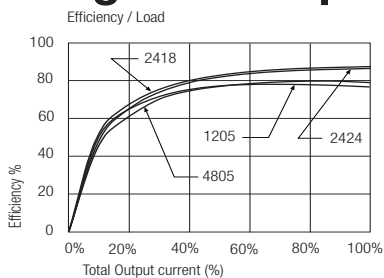

Dual 2:1 Input

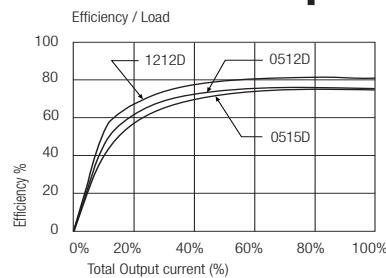

Typical Characteristics - Continued

Single 4:1 Input

Single 4:1 Input

Dual 4:1 Input

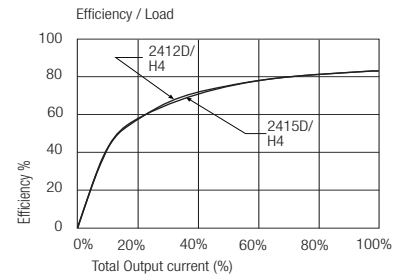
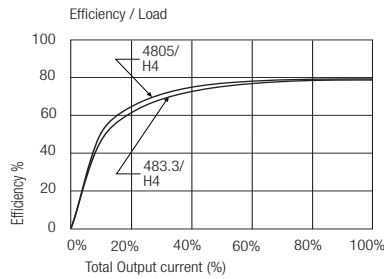
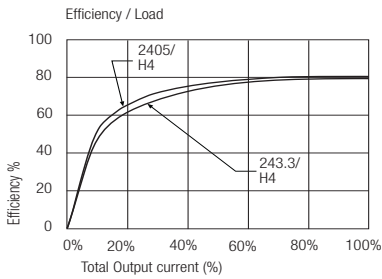

Package Style and Pinning (mm) DIP 24 , Wide Input 2:1 & 4:1

"A" Pinning
/H2, /H4 & /H6

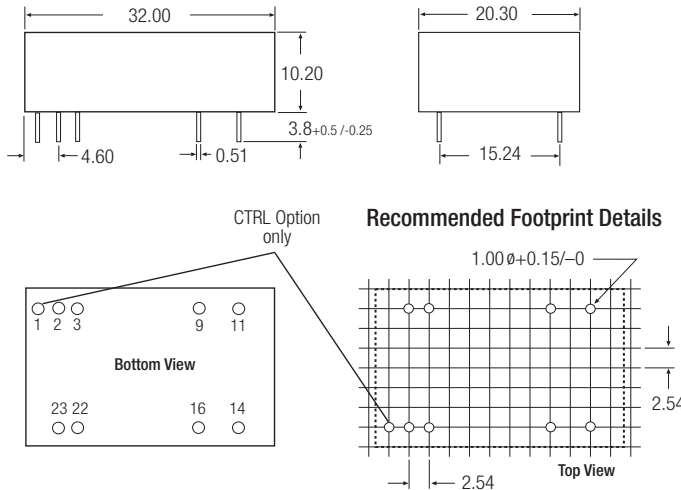

Pin Connections

| Pin # | Single | Single/X2 | Dual |
|------------|--------|-----------|-------|
| 1 (option) | CTRL | CTRL | CTRL |
| 2 | -Vin | -Vin | -Vin |
| 3 | -Vin | -Vin | -Vin |
| 9 | NC | No Pin | Com |
| 11 | NC | NC | -Vout |
| 14 | +Vout | +Vout | +Vout |
| 16 | -Vout | -Vout | Com |
| 22 | +Vin | +Vin | +Vin |
| 23 | +Vin | +Vin | +Vin |

NC = No Connection
XX.X ± 0.5 mm
XX.XX ± 0.25 mm

CTRL Option

ON = Open or $0V < V_{ctrl} < 1.2V$
OFF = $2.2V < V_{ctrl} < 12V$

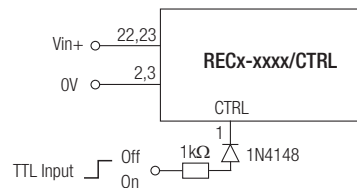

"C" Pinning
/H2, /H4 & /H6

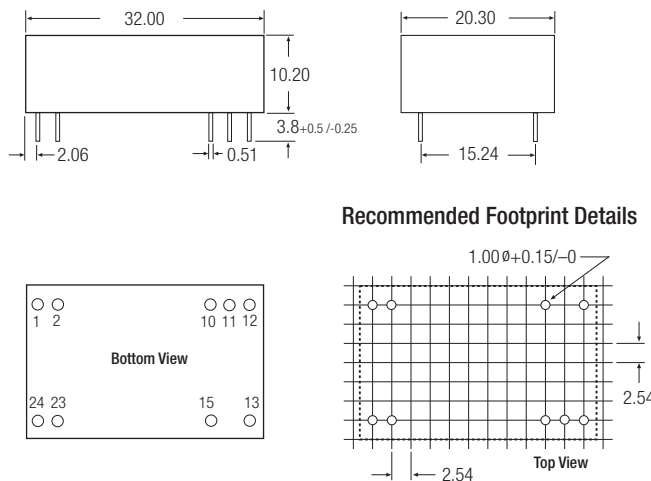

Pin Connections

| Pin # | Single | Dual |
|-------|--------|-------|
| 1 | +Vin | +Vin |
| 2 | +Vin | +Vin |
| 10 | NC | Com |
| 11 | NC | Com |
| 12 | -Vout | NC |
| 13 | +Vout | -Vout |
| 15 | NC | +Vout |
| 23 | -Vin | -Vin |
| 24 | -Vin | -Vin |

NC = No Connection
XX.X ± 0.5 mm
XX.XX ± 0.25 mm

"B" Pinning
/H (1.6kV Only)

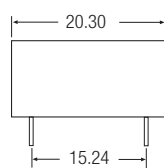
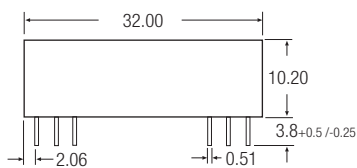

Recommended Footprint Details

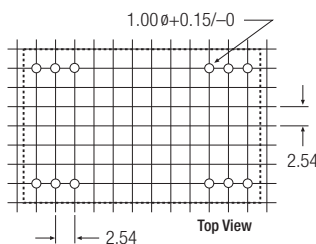
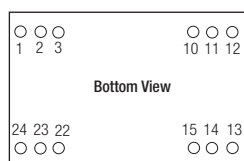

Pin Connections

| Pin # | Single | Dual |
|-------|--------|-------|
| 1 | +Vin | +Vin |
| 2 | No Pin | -Vout |
| 3 | No Pin | Com |
| 10 | -Vout | Com |
| 11 | +Vout | +Vout |
| 12 | -Vin | -Vin |
| 13 | -Vin | -Vin |
| 14 | +Vout | +Vout |
| 15 | -Vout | Com |
| 22 | No Pin | Com |
| 23 | No Pin | -Vout |
| 24 | +Vin | +Vin |

NC = No Connection

XX.X ± 0.5 mm

XX.XX ± 0.25 mm

SMD Pinning

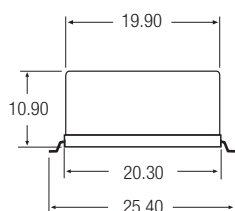
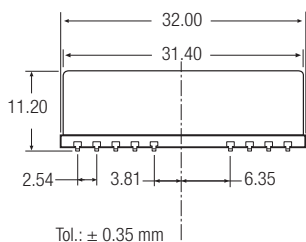

Recommended Footprint Details

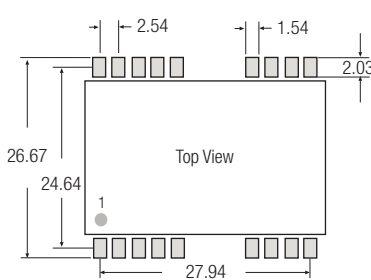
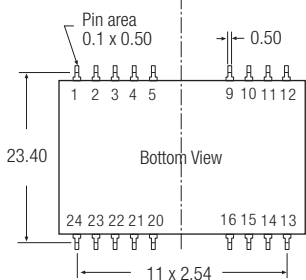

SMD pin connections follow standard package A (/A/SMD), B (/B/SMD) or C (/C/SMD) pinning.

All unused pins are NC (No Connection). See Below for detailed pinout lists

for all packages incl.SMD case the length of plastic case is 31,8 mm, length of metal case 32.0 mm

/A/SMD Pinning

/B/SMD Pinning

/C/SMD Pinning

| Pin Connections | | | Pin Connections | | | Pin Connections | | | Pin Connections | | | Pin Connections | | |
|-----------------|--------|-------|-----------------|--------|-------|-----------------|--------|-------|-----------------|--------|-------|-----------------|--------|------|
| Pin # | Single | Dual | Pin # | Single | Dual | Pin # | Single | Dual | Pin # | Single | Dual | Pin # | Single | Dual |
| 1 (Option) | CTRL | CTRL | 13 | NC | NC | 1 | +Vin | +Vin | 13 | -Vin | -Vin | 1 | +Vin | +Vin |
| 2 | -Vin | -Vin | 14 | +Vout | +Vout | 2 | NC | -Vout | 14 | +Vout | +Vout | 2 | +Vin | +Vin |
| 3 | -Vin | -Vin | 15 | NC | NC | 3 | NC | Com | 15 | -Vout | Com | 3 | NC | NC |
| 4 | NC | NC | 16 | -Vout | Com | 4 | NC | NC | 16 | NC | NC | 4 | NC | NC |
| 5 | NC | NC | 20 | NC | NC | 5 | NC | NC | 20 | NC | NC | 5 | NC | NC |
| 9 | NC | Com | 21 | NC | NC | 9 | NC | NC | 21 | NC | NC | 9 | NC | NC |
| 10 | NC | NC | 22 | +Vin | +Vin | 10 | -Vout | Com | 22 | NC | Com | 10 | NC | Com |
| 11 | NC | -Vout | 23 | +Vin | +Vin | 11 | +Vout | +Vout | 23 | NC | -Vout | 11 | NC | Com |
| 12 | NC | NC | 24 | NC | NC | 12 | -Vin | -Vin | 24 | +Vin | +Vin | 12 | -Vout | NC |