



(Pin mounted style)



(Lead wire style)



■ **Features**

- Wide DC input voltage operation 9.5~32V
- DC/DC step-up converter
- Constant current output : 700mA to 1750mA
- Wide output LED forward voltage up to 80V DC
- High efficiency up to 96%
- 2 in 1 dimming (0-10V,PWM)
- Protections: Short circuit / Over voltage
- Cooling by free air convection
- Fully encapsulated
- 3 years warranty

■ **Applications**

- DC battery source lighting
- Portable lighting
- LED solar street lighting
- LED greenhouse lighting
- LED Low-bay lighting

■ **Description**

LDH-65 series is a 65W DC/DC LED driver featuring constant current output. LDH-65 operates from 9.5~32VDC and offers models with different rated current ranging between 700mA and 1750mA. With the high efficiency up to 96%, The 94V-0 flame retardant plastic case the fully-potted silicone enhance the heat dissipation allows this series to fit solar LED street light. LDH-65 is equipped with various function options, such as dimming methodologies, so as to provide the optimal design flexibility for DC source LED lighting system.

■ **Model Encoding**

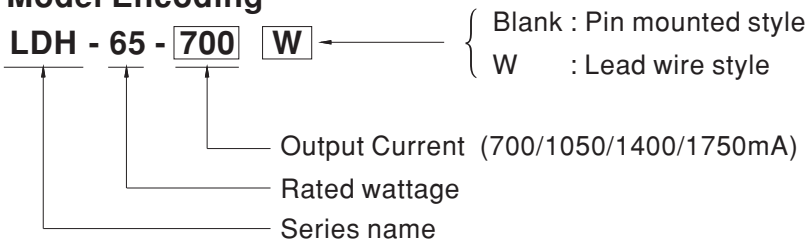



SPECIFICATION

MODEL	LDH-65-700	LDH-65-1050	LDH-65-1400	LDH-65-1750					
OUTPUT	RATED CURRENT	700mA	1050mA	1400mA	1750mA				
	CURRENT ACCURACY(Typ.)	±5% at 12VDC input and 24VDC input							
	VOLTAGE RANGE Note.2	12.5~80VDC	12.5~60VDC	12.5~46VDC	12.5~37VDC				
	RATED POWER	56.0W	63.0W	64.4W	64.75W				
	CURRENT RIPPLE	5%(@rated current)							
INPUT	VOLTAGE RANGE Note.2	9.5~32VDC							
	EFFICIENCY (Typ.)	91%/12V	95%/24V	91.5%/12V	95.5%/24V	92%/12V	95%/24V	92.5%/12V	96%/24V
	DC CURRENT (Typ.)	6.2A/12VDC, 3.1A/24VDC							
DIMMING	DIMMING FUNCTION Note.2	Leave open if not used 1KHz-3KHz 10V PWM signal or 0-10V DC input							
	QUIESCENT INPUT CURRENT IN SHUTDOWN MODE(Typ.)	10mA when PWM dimming OFF @12VDC							
PROTECTION	SHORT CIRCUIT	Output short circuit, the power supply will be damaged							
	OVER VOLTAGE	81~120V	61~100V	47~80V	38~60V				
	NO LOAD	Output voltage rise to OVP, and drop equal to input voltage, re-power to recovery							
ENVIRONMENT	WORKING TEMP.	-40 ~ +60°C (Refer to "Derating Curve")							
	WORKING HUMIDITY	20 ~ 90% RH non-condensing							
	STORAGE TEMP., HUMIDITY	-40 ~ +85°C, 10 ~ 95% RH							
	TEMP. COEFFICIENT	±0.03%/°C (0 ~ 50°C)							
SAFETY & EMC	VIBRATION	10 ~ 500Hz, 2G 10min./1cycle, period for 60min. each along X, Y, Z axes							
	SAFETY STANDARDS	IEC 61347-1, IEC 61347-2-13, EAC TP TC 004 approved							
	EMC EMISSION Note.5	Compliance to EN55015;EAC TP TC 020							
OTHERS	EMC IMMUNITY	Compliance to EN61547,EN61000-4-2,3,4,6,8; light industry level, criteria A;EAC TP TC 020							
	MTBF	3067. 44K hrs min. Telcordia TR/SR-332(Bellcore); 874.98 Khrs min. MIL-HDBK-217F (25°C)							
	DIMENSION	75*53*22.7mm (L*W*H)							
NOTE	PACKING	Pin mounted style: 152g; 100pcs/15.2kg/0.86CUFT Lead wire style: 159g; 100pcs/15.9kg/1.07CUFT							
	1.All parameters are specified at normal input(12VDC), rated load, 25°C 70% RH ambient. 2.Non dimming application: Output voltage must step up by 3 volts from input DC voltage Dimming application: Output voltage must be twice higher than the input DC voltage If input voltage down below 11, the output current may drop to more than 80% of the rated current 3.This series meets the typical life expectancy of >35,000 hours of operation when Tcase, particularly tc point (or TMP, per DLC), is about 80°C or less. 4.The ambient temperature derating of 3.5°C/1000m with fanless models and of 5°C/1000m with fan models for operating altitude higher than 2000m(6500ft). 5.EN55015 EMI testing layout is based on DC input with a battery source.								

Mechanical Specification

- All dimensions in mm(inch)
- Pin size is: $1 \pm 0.05\text{mm}$ ($0.04'' \pm 0.005''$)

LDH (PIN Style):

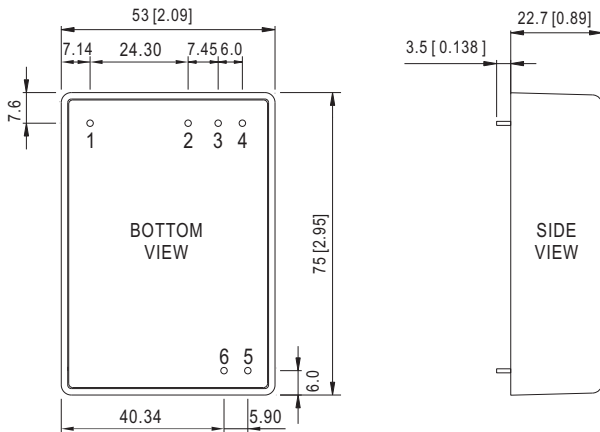

Pin Configuration

Pin No.		Comment
1	Vin+	DC Supply
2	Vin-	DC Supply, Don't connect to Vout-
3	Dim-	2 in 1 dimming
4	Dim+	2 in 1 dimming
5	Vout-	LED- connection
6	Vout+	LED+ connection

LDH (Lead Wire Style):

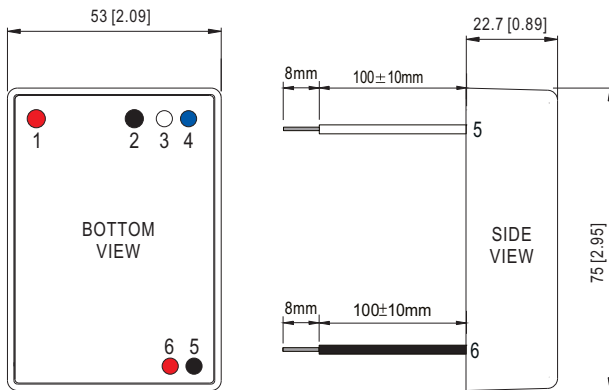

Pin No.		Comment
1	Vin+ (Red)	DC Supply
2	Vin- (Black)	DC Supply Don't connect to Vout-
3	Dim- (White)	2 in 1 dimming
4	Dim+ (Blue)	2 in 1 dimming
5	Vout- (Black)	LED- connection
6	Vout+ (Red)	LED+ connection

Derating Curve

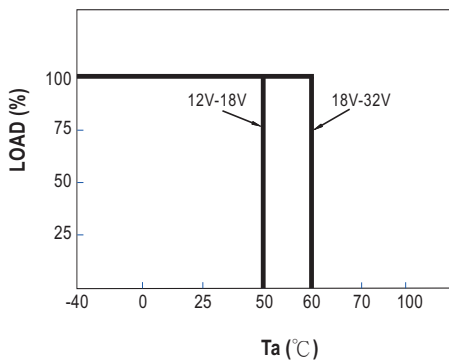

Static Characteristics

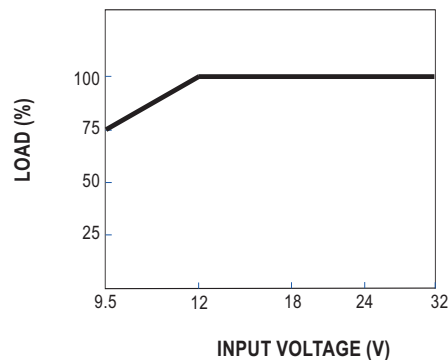

■ Standard Application

※ 2 in 1 dimming function

- Output constant current level can be adjusted by applying one of the three methodologies between DIM+ and DIM-:
0 ~ 10VDC, or 10V PWM signal
- Direct connecting to LEDs is suggested. It is not suitable to be used with additional drivers.

◎ Applying additive 0 ~ 10VDC

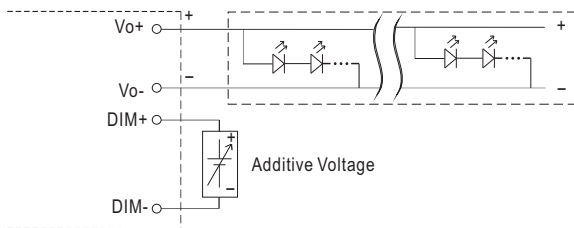

"DO NOT connect "DIM- to Vo-"

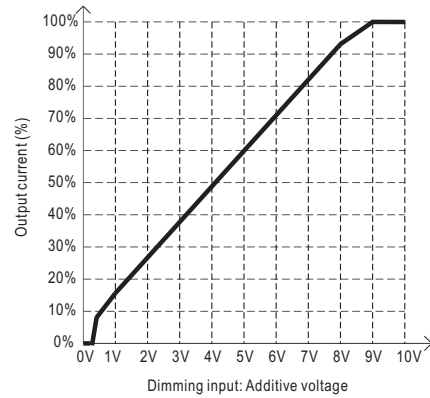

◎ Applying additive 10V PWM signal (frequency range 1KHz ~ 3KHz):

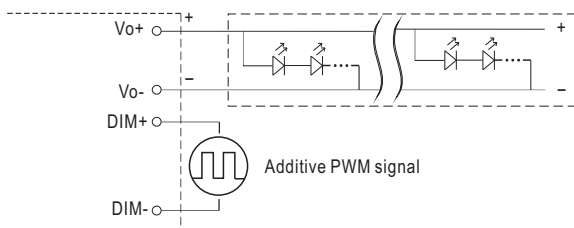

"DO NOT connect "DIM- to Vo-"

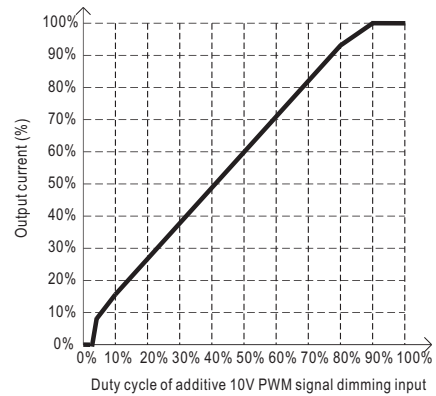

Note: 1. Min. dimming level is about 8% and the output current is not defined when $0\% < I_{out} < 8\%$.

2. The output voltage is about equal to input voltage when dimming input is about 0Vdc, or 10V PWM signal with 0% duty cycle.

■ Efficiency VS Load

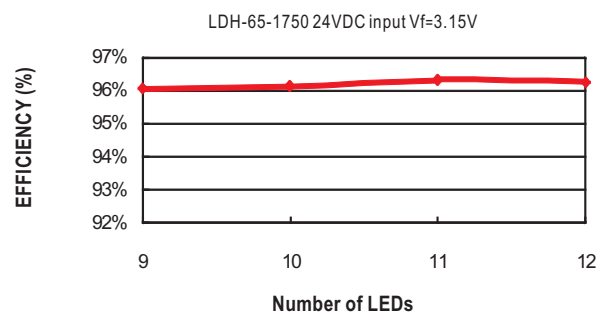
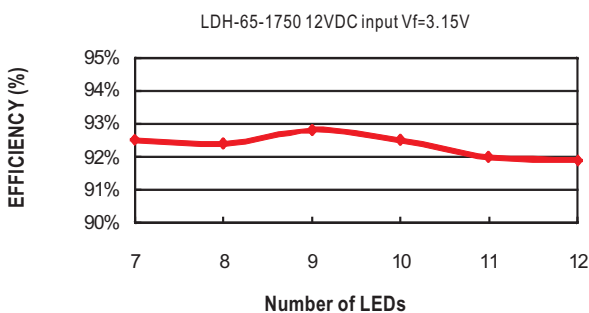
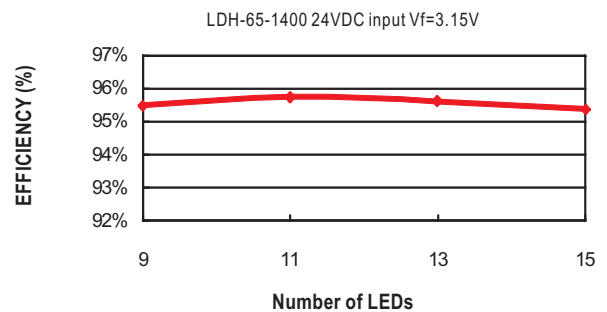
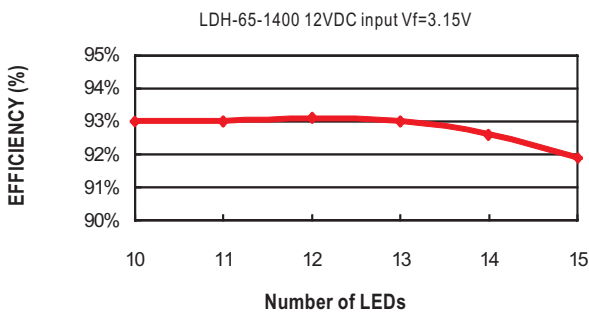
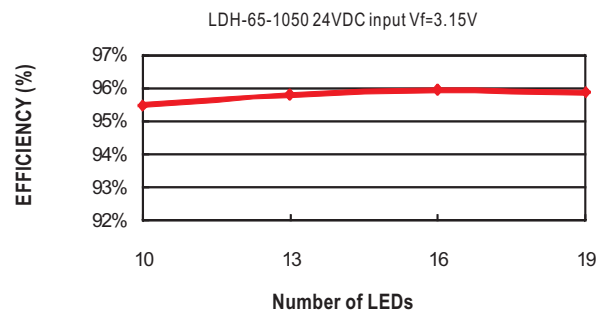
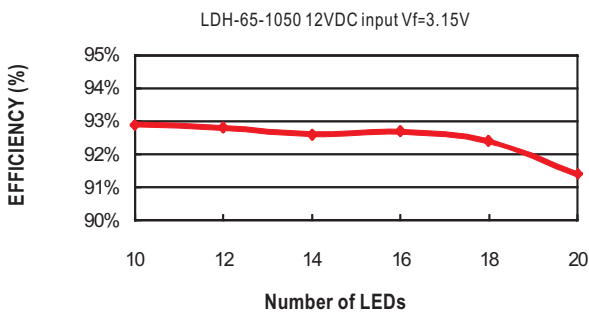
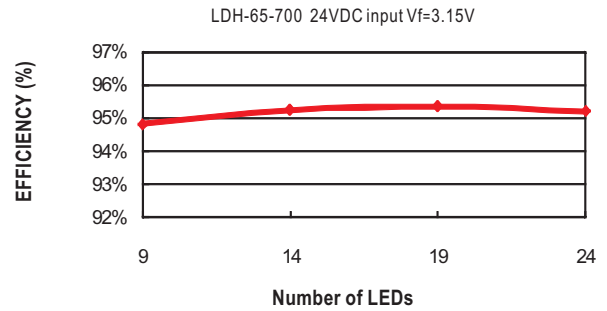
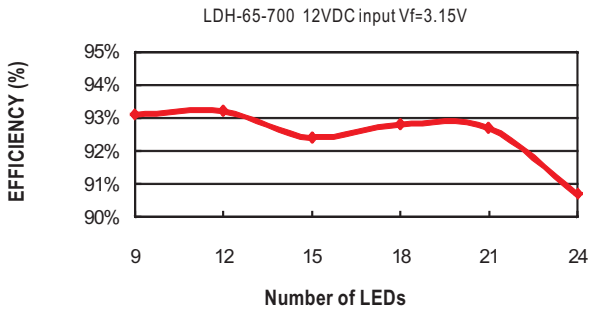

Application Notes:

1. The positive and negative input terminals must be connected correctly and negative voltage can not be input to avoid damage to the power supply.
2. Due to the large input current, please pay attention to the voltage drop of the wiring, to ensure the power supply to work properly.
3. At dim off, LDH output voltage will drop to the same level as input voltage. To get luminaires complete dark, please make luminaires are light off when they are driving by the input voltage.

■ Application Notes of EMC

1. If LDH-65 is powered by a battery, comply with EN55015 without additional Input filter and capacitors.
2. If LDH-65 is powered by DC Bus, additional EMC filter parts shall be added to meet EN55015. The recommended circuit is shown in Figure1

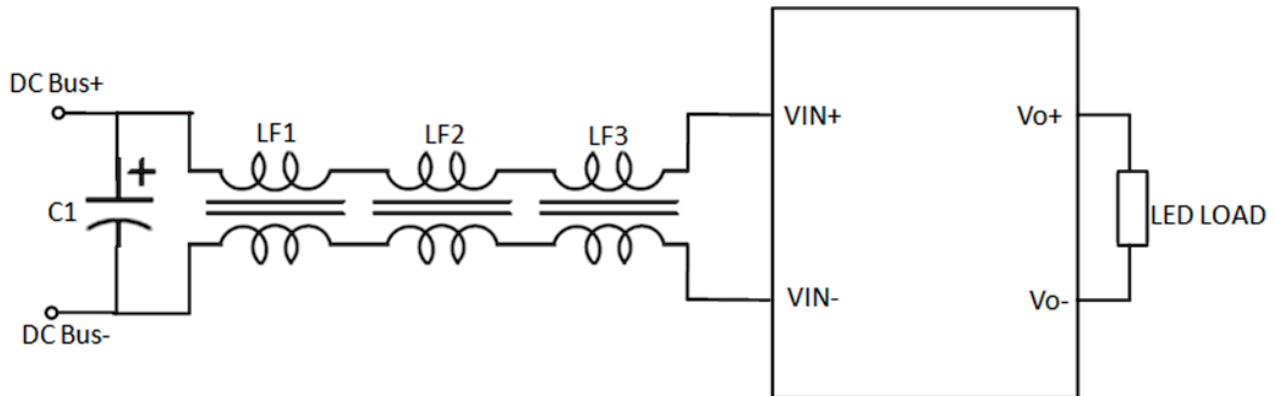

Figure 1

Figure 1:Parameter description	
C1	Electrolytic capacitor 100uF/50V
LF1/LF2	Common Mode Choke(parallel): 10.7mH/Ring code(T31×19×12)/wire(1mm×1)/36 Turns (Mn-Zn Ferrite/ $\mu_i=7000\pm25\%/AL=8220\pm30\%nH/N^2$)
LF3	Common Mode Choke(Separate): 370 μ H/Ring code(T25×15×12)/wire(1mm×1)/17 Turns (Ni-Zn Ferrite/ $\mu_i=800\pm25\%$)