

211769-5 ACTIVE

AMP | AMP CPC

TE Internal #: 211769-5

AMP CPC, Circular Power Connectors, Housing, Operating Voltage
600 VDC, Wire-to-Wire, 9 Position, Wire & Cable, Receptacle,
Reverse Gender, Socket

[View on TE.com >](#)



Connectors > Power Connectors > Circular Power > Circular Power Connectors



Connector Product Type: **Housing**

Operating Voltage: **600 VDC**

Connector System: **Wire-to-Wire**

Number of Positions: **9**

Sealable: **No**

Features

Product Type Features

Connector Product Type	Housing
Connector System	Wire-to-Wire
Sealable	No
Connector & Contact Terminates To	Wire & Cable
Connector & Housing Type	Receptacle
Circular Connector Shell Type	All Plastic

Configuration Features

Reverse Numbering	Without
Number of Positions	9
Number of Power Positions	0
Keying	A
Number of Signal Positions	9

Electrical Characteristics

Operating Voltage	600 VAC
-------------------	---------

Contact Features

Reverse Gender	Yes
Contact Type	Socket
Contact Protection	With



Mechanical Attachment

Panel Mount Feature Type	Flange with Threaded Inserts
Screw & Hole Thread Size	15/16-20 UNEF-2A
Connector Mounting Type	Panel Mount
Mating Alignment	With
Mating Retention	With
Panel Mount Feature	With
Mating Alignment Type	Keyed
Mating Retention Type	Threaded Coupling

Housing Features

Body Orientation	Straight
Housing Color	Black
Housing Material	Nylon, Thermoplastic
Circular Connector Shell Size	17

Usage Conditions

Operating Temperature Range	-55 – 105 °C[-67 – 221 °F]
Fluid Resistance	None

Operation/Application

Circuit Application	Power & Signal
Shielded	No

Industry Standards

UL Flammability Rating	UL 94V-0
VDE Tested	Yes

Packaging Features

Packaging Method	Package
Packaging Quantity	1

Product Compliance

[For compliance documentation, visit the product page on TE.com>](#)

EU RoHS Directive 2011/65/EU	Compliant
EU ELV Directive 2000/53/EC	Compliant
China RoHS 2 Directive MIIT Order No 32, 2016	No Restricted Materials Above Threshold

EU REACH Regulation (EC) No. 1907/2006

Current ECHA Candidate List: JUN 2020 (209)

Candidate List Declared Against: JUN 2020 (209)

Does not contain REACH SVHC

Halogen Content

BFR/CFR/PVC Free, but Br/Cl >900 ppm in other sources.

Solder Process Capability

Not applicable for solder process capability

Product Compliance Disclaimer

This information is provided based on reasonable inquiry of our suppliers and represents our current actual knowledge based on the information they provided. This information is subject to change. The part numbers that TE has identified as EU RoHS compliant have a maximum concentration of 0.1% by weight in homogenous materials for lead, hexavalent chromium, mercury, PBB, PBDE, DBP, BBP, DEHP, DIBP, and 0.01% for cadmium, or qualify for an exemption to these limits as defined in the Annexes of Directive 2011/65/EU (RoHS2). Finished electrical and electronic equipment products will be CE marked as required by Directive 2011/65/EU. Components may not be CE marked. Additionally, the part numbers that TE has identified as EU ELV compliant have a maximum concentration of 0.1% by weight in homogenous materials for lead, hexavalent chromium, and mercury, and 0.01% for cadmium, or qualify for an exemption to these limits as defined in the Annexes of Directive 2000/53/EC (ELV). Regarding the REACH Regulation, the information TE provides on SVHC in articles for this part number is based on the latest European Chemicals Agency (ECHA) 'Guidance on requirements for substances in articles' posted at this URL: <https://echa.europa.eu/guidance-documents/guidance-on-reach>

Compatible Parts



Also in the Series | AMP CPC

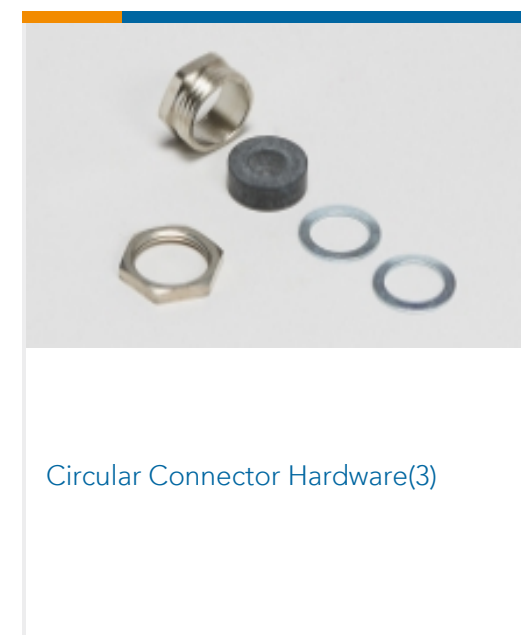
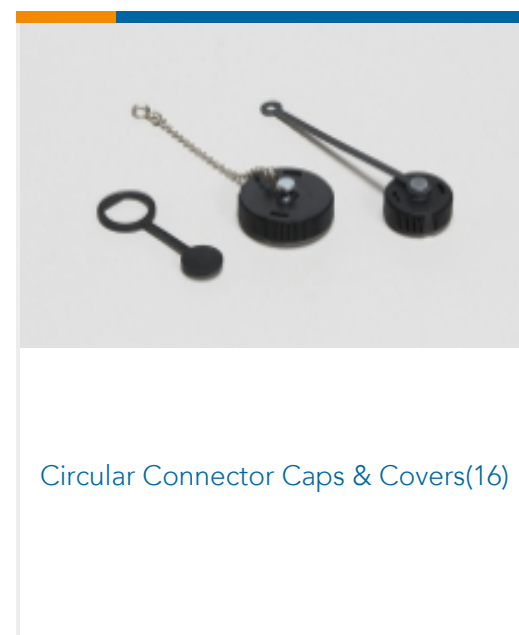
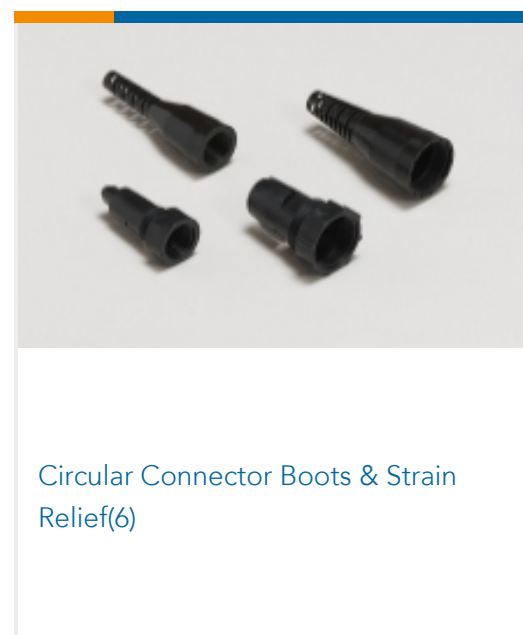
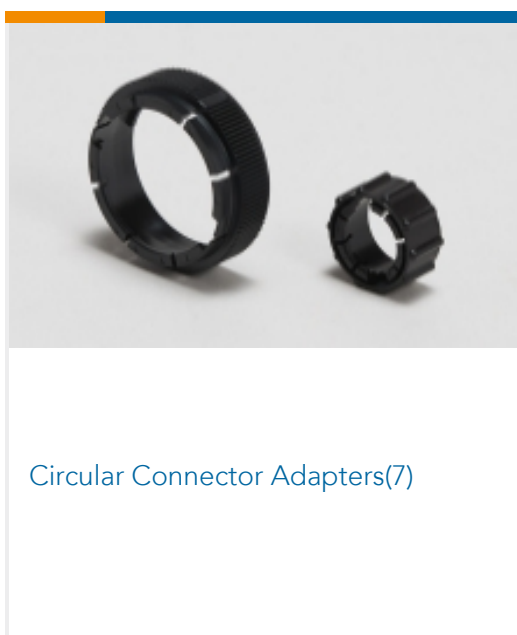



Circular Connector Keying Plugs(2)

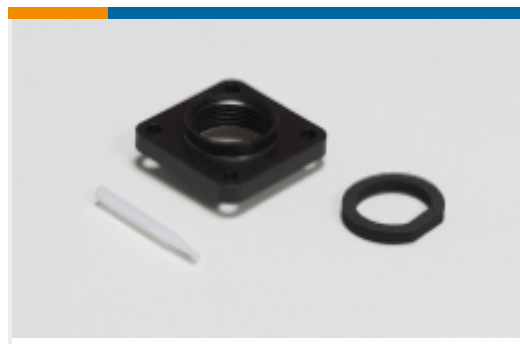

Circular Connector Seals(35)



Circular Power Connectors(513)

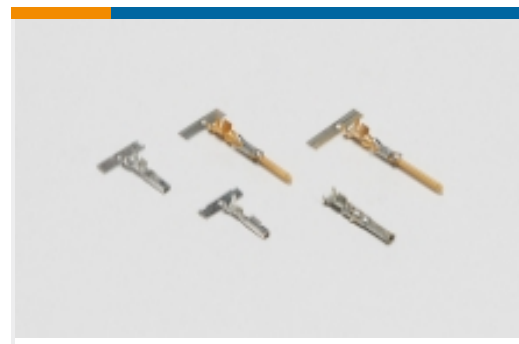

Power Contacts(5)

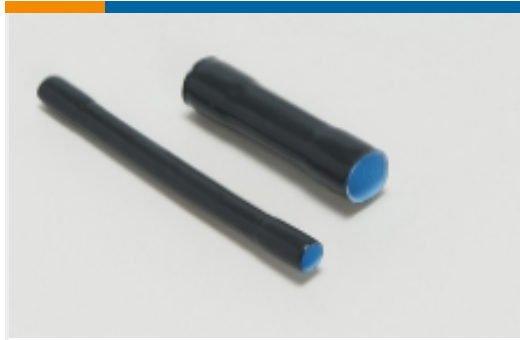

Sealing & Repair Sleeves(2)



Unscreened Circular Connector Backshells & Clamps(56)

Customers Also Bought

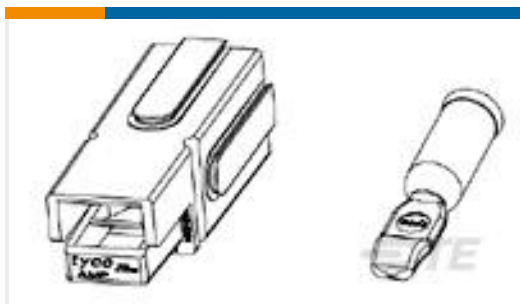

TE Model / Part #1604002-2
120A SGL POLE KIT, 2 AWG BLACK

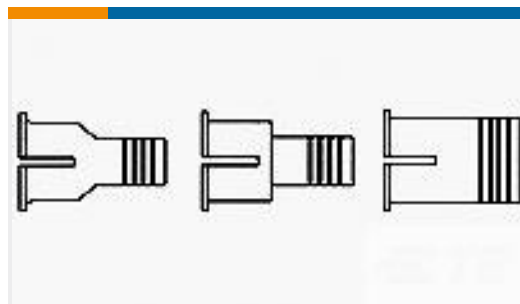

TE Model / Part #7-745129-9
SHLDING FERRULE,PLTD,BULK PKG



TE Model / Part #1648211-1
423-0001-01100



TE Model / Part #1-770003-0
UMNL II PIN DUPLX AUSN/NI/PHBZ



TE Model / Part #770416-6
UMNL II SOK.AU/PHBZ L/P



TE Model / Part #213426-1
PLG HSG,3 POWR,12 SGNL,METRI



TE Model / Part #5-212502-1
RECEPT ASSY,9C4,AMPLIMITE

Documents

Product Drawings

17-9 CPC RECEPT REV SEX

English

CAD Files

3D PDF

3D

Customer View Model

ENG_CVM_CVM_211769-5_AD.2d_dxf.zip



English

Customer View Model

[ENG_CVM_CVM_211769-5_AD.3d_igs.zip](#)

English

Customer View Model

[ENG_CVM_CVM_211769-5_AD.3d_stp.zip](#)

English

By downloading the CAD file I accept and agree to the [Terms and Conditions](#) of use.

Product Environmental Compliance

[TE Material Declaration](#)

English

Agency Approvals

[UL Report](#)

English