

3-826632-6 ✓ ACTIVE

AMPMODU | AMPMODU Headers

TE Internal #: 3-826632-6

AMPMODU Headers, PCB Mount Header, Vertical, Board-to-Board, 72 Position, 2.54mm [.1in] Centerline, Breakaway

[View on TE.com >](#)



Connectors > PCB Connectors > Board-to-Board Connectors > Board-to-Board Headers & Receptacles



PCB Connector Assembly Type: **PCB Mount Header**

PCB Mount Orientation: **Vertical**

Connector System: **Board-to-Board**

Number of Positions: **72**

Centerline (Pitch): **2.54 mm [.1 in]**

## Features

### Product Type Features

PCB Connector Assembly Type	PCB Mount Header
Connector System	Board-to-Board
Header Type	Breakaway
Sealable	No
Connector & Contact Terminates To	Printed Circuit Board

### Configuration Features

Number of Rows	2
Connector Contact Load Condition	Fully Loaded
PCB Mount Orientation	Vertical
Number of Positions	72
Board-to-Board Configuration	Parallel

### Electrical Characteristics

Insulation Resistance	5000 MΩ
Dielectric Withstanding Voltage (Max)	750 Vrms

### Contact Features

Mating Square Post Dimension	.63 mm[.025 in]
PCB Contact Termination Area Plating Material Thickness	3 μm
Contact Shape & Form	Square
Contact Underplating Material	Nickel



PCB Contact Termination Area Plating Material	Tin
Contact Base Material	Phosphor Bronze
Contact Mating Area Plating Material	Gold or Gold Flash over Palladium Nickel
Contact Mating Area Plating Material Thickness	.8 $\mu$ m[31.5 $\mu$ in]
Contact Type	Pin
Contact Current Rating (Max)	5 A

#### Termination Features

Square Termination Post & Tail Dimension	.63 mm[.025 in]
Termination Post & Tail Length	3.2 mm[.1259 in]
Termination Method to Printed Circuit Board	Through Hole - Solder

#### Mechanical Attachment

Mating Alignment	Without
PCB Mount Retention	Without
PCB Mount Alignment	Without
Connector Mounting Type	Board Mount

#### Housing Features

Centerline (Pitch)	2.54 mm[.1 in]
Housing Color	Green
Housing Material	PBT

#### Dimensions

Row-to-Row Spacing	2.54 mm[.1 in]
PCB Thickness (Recommended)	1.57 mm[.062 in]

#### Usage Conditions

Housing Temperature Rating	Standard
Operating Temperature Range	-65 – 105 °C[-85 – 221 °F]

#### Operation/Application

Circuit Application	Signal
---------------------	--------

#### Industry Standards

UL Flammability Rating	UL 94V-0
------------------------	----------

#### Packaging Features

Packaging Quantity	150
--------------------	-----

Packaging Method

Carton

## Product Compliance

[For compliance documentation, visit the product page on TE.com>](#)

EU RoHS Directive 2011/65/EU	Compliant
EU ELV Directive 2000/53/EC	Compliant
China RoHS 2 Directive MIIT Order No 32, 2016	No Restricted Materials Above Threshold
EU REACH Regulation (EC) No. 1907/2006	Current ECHA Candidate List: JUN 2020 (209) Candidate List Declared Against: JAN 2020 (205) Does not contain REACH SVHC
Halogen Content	Not Low Halogen - contains Br or Cl > 900 ppm.
Solder Process Capability	Wave solder capable to 265°C

### Product Compliance Disclaimer

This information is provided based on reasonable inquiry of our suppliers and represents our current actual knowledge based on the information they provided. This information is subject to change. The part numbers that TE has identified as EU RoHS compliant have a maximum concentration of 0.1% by weight in homogenous materials for lead, hexavalent chromium, mercury, PBB, PBDE, DBP, BBP, DEHP, DIBP, and 0.01% for cadmium, or qualify for an exemption to these limits as defined in the Annexes of Directive 2011/65/EU (RoHS2). Finished electrical and electronic equipment products will be CE marked as required by Directive 2011/65/EU. Components may not be CE marked. Additionally, the part numbers that TE has identified as EU ELV compliant have a maximum concentration of 0.1% by weight in homogenous materials for lead, hexavalent chromium, and mercury, and 0.01% for cadmium, or qualify for an exemption to these limits as defined in the Annexes of Directive 2000/53/EC (ELV). Regarding the REACH Regulation, the information TE provides on SVHC in articles for this part number is based on the latest European Chemicals Agency (ECHA) 'Guidance on requirements for substances in articles' posted at this URL: <https://echa.europa.eu/guidance-documents/guidance-on-reach>

## Compatible Parts

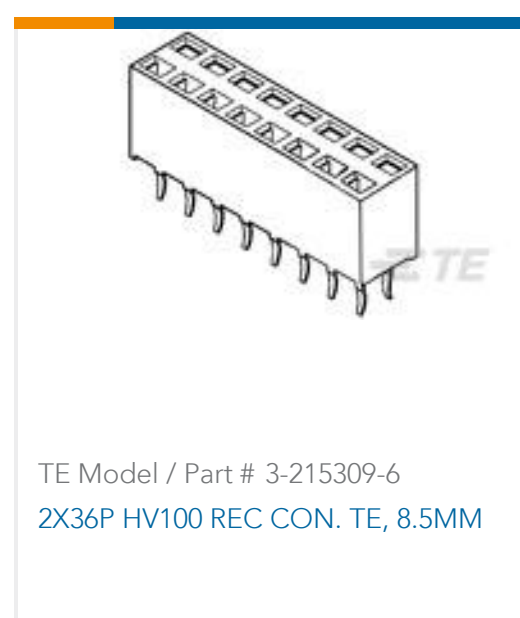
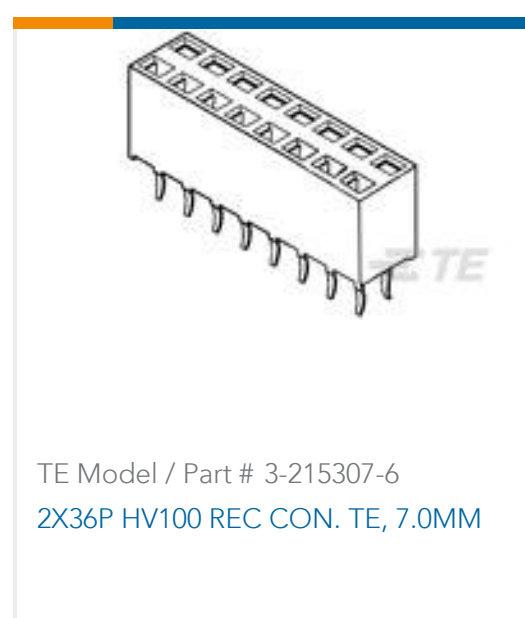

Also in the Series | [AMPMODU Headers](#)



Automotive Headers(10)

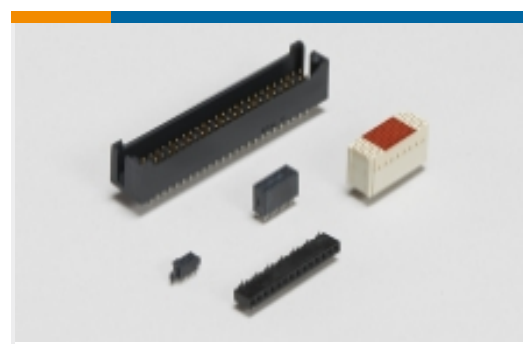

Board-to-Board Headers & Receptacles(5340)

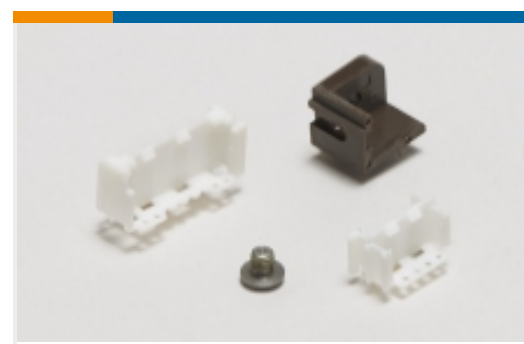

PCB Connector Mounting(1)



PCB Connector Shrouds(1)



PCB Latches, Locks & Retainers(2)



Wire-to-Board Connector Assemblies & Housings(3)



Wire-to-Board Connector Contacts(46)

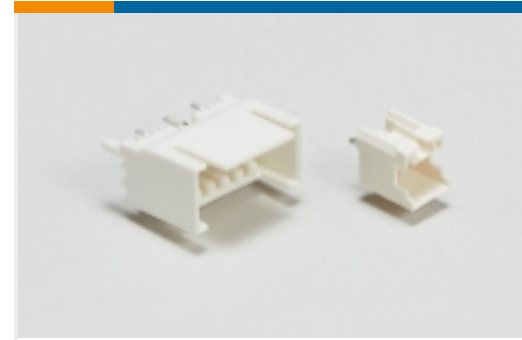

Wire-to-Board Headers & Receptacles (79)

## Customers Also Bought

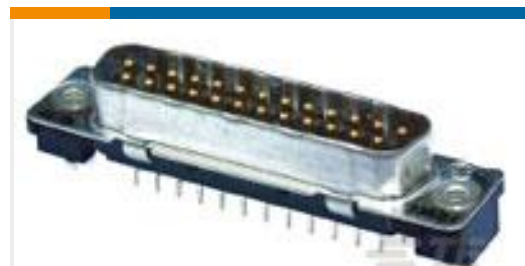

TE Model / Part #5-338311-2  
25POS.HD20 PLUG ASS



TE Model / Part #5-338313-2  
9POS.HD-20 REC.ASSY



TE Model / Part #3-826634-6  
36P MOD2 STIFT LEI

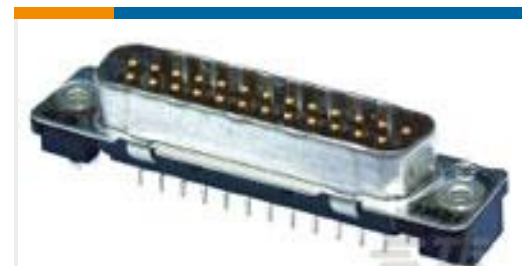

TE Model / Part #5-338309-2  
9P.HDP20 PLUG ASSY



TE Model / Part #3-826631-6  
36P AMPMODU II STIFT LEI



TE Model / Part #5677862005  
RNF-3000-9/3-9-STK



TE Model / Part #5677902003  
RNF-3000-1.5/0.5-X-STK



TE Model / Part #5677832002  
RNF-3000-1.5/0.5-9-STK



TE Model / Part #1337815-2  
50 OHM COAX SMB STR PLUG STR P

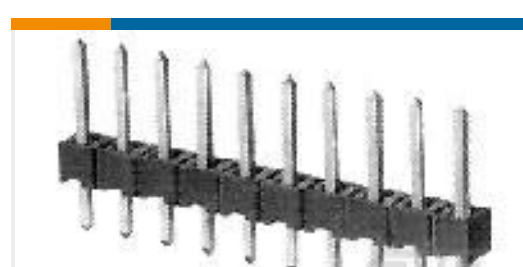

TE Model / Part #3-826629-6  
1X36 POS AMPMODU II HEADER

## Documents



### Product Drawings

#### 36P AMPMODU II STIFT LEI

English

---

### CAD Files

#### 3D PDF

3D

#### Customer View Model

[ENG\\_CVM\\_CVM\\_3-826632-6\\_R.2d\\_dxf.zip](#)

English

#### Customer View Model

[ENG\\_CVM\\_CVM\\_3-826632-6\\_R.3d\\_igs.zip](#)

English

#### Customer View Model

[ENG\\_CVM\\_CVM\\_3-826632-6\\_R.3d\\_stp.zip](#)

English

By downloading the CAD file I accept and agree to the [Terms and Conditions](#) of use.

---

### Agency Approvals

#### UL Report

English