



Type 6213EV can be combined with...





**Type 2508**  
Cable plug



**Type 2513**  
Cable plug  
(ATEX Cat. 3 GD)

## Servo-assisted 2/2 way diaphragm valve

- Servo-assisted diaphragm with diameter of up to DN 40
- Spring coupled diaphragm opens without differential pressure
- Vibration-proof, screwed coil system
- Damped design for quiet closing
- Press mould housing with high surface quality
- Approvals:   

The 6213 EV valve is a servo-assisted solenoid valve of the S.EV series. The spring coupling of the diaphragm supports the opening process of the valve. In its standard version, the valve is suitable for use in liquids. A minimum differential pressure is required for complete opening. A special version (HP00) which opens the valve without differential pressure is available for gas and vacuum applications. Various diaphragm material combinations are available depending on the application. The standard brass housing satisfies all European drinking water requirements. Lead-free or dezincification resistant brass types are available for other markets. The housing offering is rounded out by a stainless steel version. The solenoid coils are moulded with a chemically resistant epoxy. For reduced energy requirement, all coils can be delivered with electronic power reduction. In combination with a plug in accordance with DIN EN 17301-803 Form A, the valves satisfy protection class IP65 – in combination with a stainless steel housing NEMA 4X.

### Circuit function A

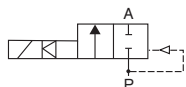

Servo-assisted 2/2-way valve; normally closed, with 2-way pilot control

Technical data	
<b>Orifice</b>	Standard DN 10 - 40 mm HP00: DN13-20
<b>Body material</b>	Brass acc. to DIN EN 50930-6, stainless steel 1.4408 (316), nickel-plated brass (5µm)
<b>Inner part of valve</b>	Brass body Stainless steel body
<b>Seal material</b>	NBR, FKM, EPDM
<b>Medium</b>	NBR FKM EPDM
	Neutral fluids, water, hydraulic oil, oil without additives Per-solutions, hot oils with additives Oil and fat-free fluids and gases
<b>Ambient temperature</b>	Max. +55 °C; Max. 131°F
<b>Medium viscosity</b>	Max. 21 mm <sup>2</sup> /s
<b>Medium temperature</b>	NBR FKM EPDM
	-10 to +80 °C; 14°F to 176°F 0 to +90 °C; 32°F to 194°F with polyamide coil / 0 to +120 °C; 32°F to 248°F with Epoxy coil -30 to +120 °C; -22°F to 248°F
<b>Voltagess</b>	Standard 024/DC, 024/50, 230/50, 110/50, 120/60 HP00: 24V (50-60Hz), 230V (50-60Hz)
<b>Voltagess tolerance</b>	±10%
<b>Duty cycle</b>	100% continuous rating
<b>Electrical connection</b>	Tag connector acc. to DIN EN 175301-803 Form A (previously DIN 43650) (see ordering chart for accessories)
<b>Protection class</b>	IP 65 with cable plug
<b>Installation</b>	As required, preferably with actuator upright
<b>Response times<sup>1)</sup></b>	0.1 - 4 seconds (depending on orifice and differential pressure)

<sup>1)</sup> Measured at valve outlet at 6 bar and +20°C

Opening: pressure build-up 0 to 90%

Closing: pressure drop 100 to 10%

## Technical data

### Power consumption

Orifice DN	Port Connection	Coil size width [mm]		Power consumption <sup>1)</sup>			Insulation class coil <sup>2)</sup>		Weight [kg]	
		AC	DC	Inrush AC [VA]	Hold (hot coil) AC [VA/W]	DC [W]	Seal material FKM	Seal material NBR and EPDM	Brass Coil AC	Brass Coil DC
10	1/4 3/8	32	40	34	14/8	10 (11)	H	B	0.33	0.41
10	1/2	32	40	34	14/8	10 (11)	H	B	0.37	0.44
13	1/2	32	40	36	14/8	10 (11)	H	B	0.46	0.54
13	3/4	32	40	36	14/8	10 (11)	H	B	0.49	0.57
20	3/4	32	40	38	14/8	10 (11)	H	B	0.74	0.82
20	1	32	40	38	14/8	10 (11)	H	B	0.95	1.03
25	1	42	65	150	37/16	28 (29)	H	H	1.6	2.2
25	1 1/4	42	65	150	37/16	28 (29)	H	H	1.7	2.3
40	1 1/4	42	65	190	37/16	28 (29)	H	H	3.2	3.7
40	1 1/2	42	65	190	37/16	28 (29)	H	H	3.2	3.7
40	2	42	65	190	37/16	28 (29)	H	H	3.38	3.9

Orifice DN	Port Connection	Coil size width [mm]	Power consumption <sup>1)</sup>			Insulation class coil <sup>2)</sup>		Weight [kg]	
			AC/DC	Inrush AC [VA]	Hold (hot coil) AC [VA/W]	DC [W]	Seal material FKM	Seal material NBR and EPDM	Brass Coil AC
13	1/2	42	125	37/16	16 (21)	H	H	0.80	0.81
13	3/4	42	125	37/16	16 (21)	H	H	0.86	0.87
20	3/4	42	140	37/16	16 (21)	H	H	1.13	1.14
20	1	42	140	37/16	16 (21)	H	H	1.30	1.31

<sup>1)</sup> Values in brackets at coil temperature 20 °C

<sup>2)</sup> H Epoxy coil, B Polyamide coil

## Materials

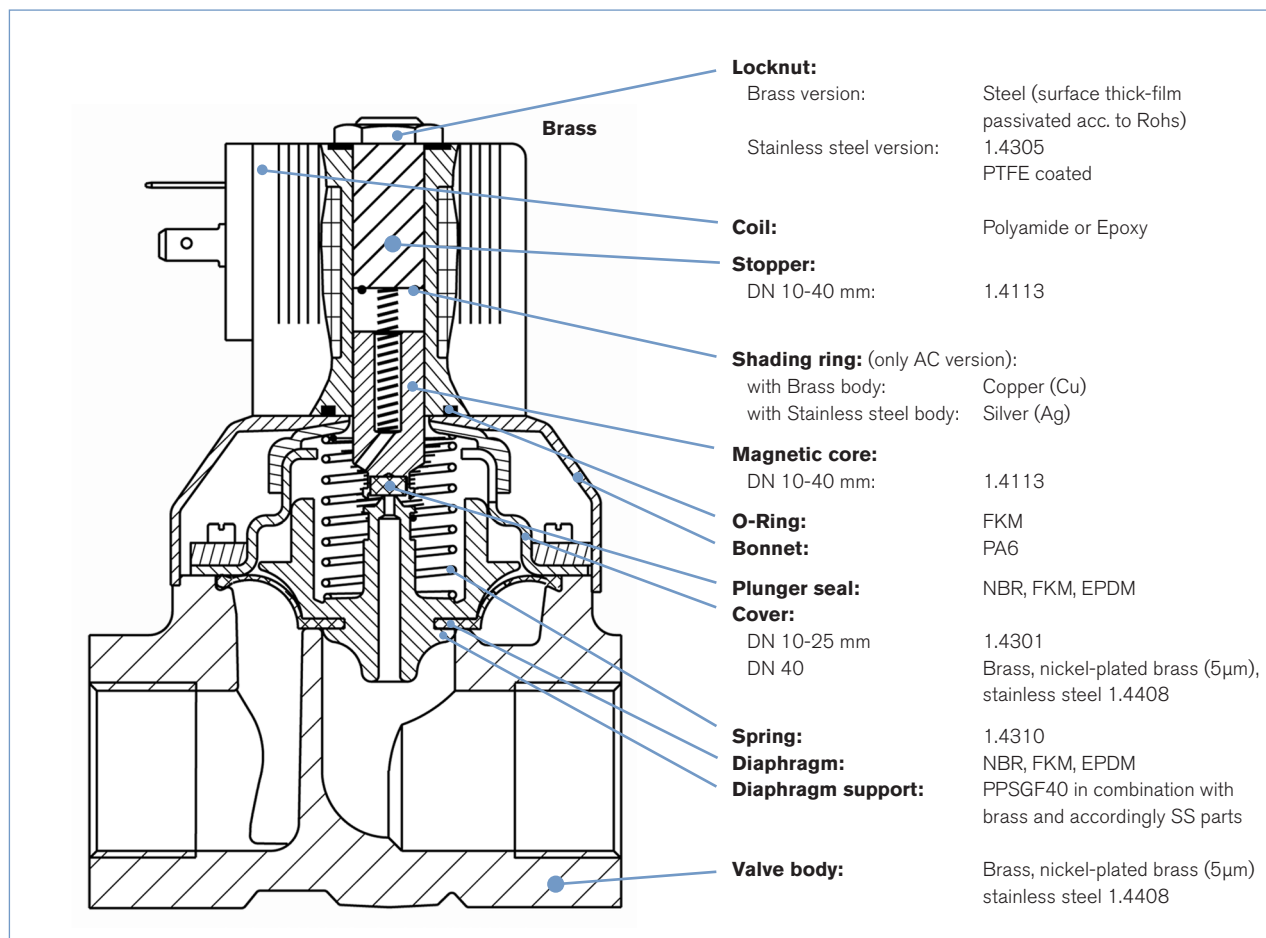

Dimensions [mm]

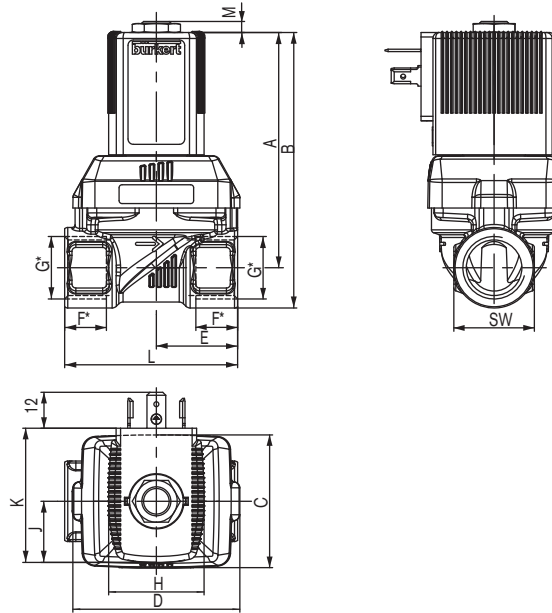

Dimensions (AC-coil, 32mm)

DN	A	B	C	D	E (MS/VA)	* G		* NPT		* Rc		H	J	K	L (MS/VA)	SW	M	
						F1	G1	F2	G2	F3	G3							
10	67.4	78.4	36	46	22	12	G 1/4	10	NPT 1/4	9.7	Rc 1/4	32	20.5	45	50	22	3.7	
	67.4	78.4			22	12	G 3/8	10.3	NPT 3/8	10.1	Rc 3/8							55/55
	69.4	82.9			24.5	14	G 1/2	13.7	NPT 1/2	13.2	Rc 1/2							27
13	78.9	92.4	44.5	56	27.2/32.5	14	G 1/2	13.7	NPT 1/2	13.2	Rc 1/2	32	20.5	45	58/65	27	3.7	
	80.9	96.9			32.5	16	G 3/4	14	NPT 3/4	14.5	Rc 3/4				65	32		
20	93.4	109.4	65	76.6	37	16	G 3/4	14	NPT 3/4	14.5	Rc 3/4	32	20.5	45	80	32	3.7	
	95.9	116.4			37.5	18	G 1	16.8	NPT 1	16.8	Rc 1				80	41		

Dimensions (DC-coil, 40mm)

DN	A	B	C	D	E (MS/VA)	* G		* NPT		* Rc		H	J	K	L (MS/VA)	SW	M	
						F1	G1	F2	G2	F3	G3							
10	67.4	78.4	36	46	22	12	G 1/4	10	NPT 1/4	9.7	Rc 1/4	40	23.5	51	50	22	3.7	
	67.4	78.4			22	12	G 3/8	10.3	NPT 3/8	10.1	Rc 3/8							50/55
	69.4	82.9			24.5	14	G 1/2	13.7	NPT 1/2	13.2	Rc 1/2							27
13	79.3	92.8	44.5	56	27.2/32.5	14	G 1/2	13.7	NPT 1/2	13.2	Rc 1/2	40	23.5	51	58/65	27	3.7	
	81.3	97.3			32.5	16	G 3/4	14	NPT 3/4	14.5	Rc 3/4				65	32		
20	93.8	109.8	65	76.6	37	16	G 3/4	14	NPT 3/4	14.5	Rc 3/4	40	23.5	51	80	32	3.7	
	96.3	116.8			37.5	18	G 1	16.8	NPT 1	16.8	Rc 1				80	41		

Dimensions (AC-coil, 42mm / DC-coil 65mm)

DN	A	B	C	D	E (MS/VA)	* G		* NPT		* Rc		H	J	K	L (MS/VA)	SW	M
						F1	G1	F2	G2	F3	G3						
40	158.3	193.3	104.5	117	64	24	G 2	17.6	NPT 2	23.4	Rc 2	65	37.5	72	132	70	7
	152.3	182.3			61	22	G1 1/2	17.3	NPT 1 1/2	19.1	Rc 1 1/2				126	60	
	146.8	171.8			61	20	G1 1/4	17.3	NPT 1 1/4	19.1	Rc 1 1/4				126	50	
25	141.3	166.3	77	88	46	20	G1 1/4	17.3	NPT 1 1/4	19.1	Rc 1 1/4	65	37.5	72	95	50	7
	136.3	156.8			46	18	G 1	16.8	NPT 1	16.8	Rc 1				95	41	
40	158.3	193.3	104.5	117	64	24	G 2	17.6	NPT 2	23.4	Rc 2	42	27	55.5	132	70	7
	152.3	182.3			61	22	G1 1/2	17.3	NPT 1 1/2	19.1	Rc 1 1/2				126	60	
	146.8	171.8			61	20	G1 1/4	17.3	NPT 1 1/4	19.1	Rc 1 1/4				126	50	
25	141.3	166.3	77	88	46	20	G1 1/4	17.3	NPT 1 1/4	19.1	Rc 1 1/4	42	27	55.5	95	50	7
	136.3	156.8			46	18	G 1	16.8	NPT 1	16.0	Rc 1				95	41	

**Dimensions [mm] (cont.)**

---

**HP00 Version  
Dimensions (coil, 42mm)**

DN	A	B	C	D	2E	* G		* NPT		* Rc		H	J	K	L	SW	M
					(MS/VA)	F1	G1	F2	G2	F3	G3				(MS/VA)		
20	119.3	139.8	65	76.6	37.5	18	G 1	16.8	NPT 1	16.8	Rc 1				80	41	
	116.8	132.8			37	16	G1 3/4	14	NPT 3/4	14.5	Rc 3/4					32	
13	104.3	120.3	44.5	56	32.5	16	G1 3/4	14	NPT 3/4	14.5	Rc 3/4	42	27	55.5	65	27	7
	102.6	115.6			27.2/32.5	14	G 1/2	13.7	NPT 1/2	13.2	Rc 1/2				58/65		
					27.2/32.5										58/65		
					58/65										27		

Ordering chart for valves (other versions on request)

Circuit function	Port size (NPT)	Orifice [mm]	Cv value	Pressure range [PSI]	Item no. per voltage/frequency [V/Hz]			
					024/60	024/DC	120/60	240/60
<b>A</b> 2/2-way valve NC 	<b>Brass body, NBR Diaphragm, epoxy coil, medium temperature -10...+80°C, UL Recognized</b>							
	1/4"	10.0	2.2	0 - 145	273 540	273 539	273 541	273 452
	3/8"	10.0	2.2	0 - 145	267 199	267 198	267 200	267 202
	1/2"	10.0	2.2	0 - 145	273 544	273 543	273 545	273 546
	1/2"	13.0	4.2	0 - 145	273 547	267 215	273 548	273 549
	3/4"	20.0	9.8	0 - 145	273 551	273 550	273 552	273 553
	1"	20.0	9.8	0 - 145	273 555	273 554	273 556	273 557
	1 1/4"	25.0	12.9	0 - 145	TBD	273 558	TBD	TBD
	1 1/2"	40.0	35.3	0 - 87	TBD	273 559	TBD	TBD
	2"	40.0	35.3	0 - 87	TBD	273 560	TBD	TBD
	<b>Brass body, FKM Diaphragm, epoxy coil, medium temperature 0...+120°C, UL Recognized</b>							
	1/4"	10.0	2.2	0 - 145	273 562	273 561	273 563	273 564
	3/8"	10.0	2.2	0 - 145	273 566	273 565	273 567	273 568
	1/2"	13.0	4.2	0 - 145	273 570	273 569	273 571	273 572
	3/4"	20.0	9.8	0 - 145	273 574	273 573	273 575	273 576
	1"	20.0	9.8	0 - 145	273 578	273 577	273 579	273 580
	1"	25.0	12.9	0 - 145	TBD	273 581	TBD	TBD
	1 1/4"	25.0	12.9	0 - 145	TBD	273 582	TBD	TBD
	1 1/2"	40.0	35.3	0 - 87	TBD	273 583	TBD	TBD
	2"	40.0	35.3	0 - 87	TBD	273 584	TBD	TBD
	<b>Stainless steel body, FKM Diaphragm, epoxy coil, medium temperature 0...+120°C, UL Recognized</b>							
	1/4"	10.0	2.2	0 - 145	273 623	273 622	273 624	273 625
	3/8"	10.0	2.2	0 - 145	273 627	273 626	273 629	273 630
	1/2"	13.0	4.2	0 - 145	273 631	273 987	273 632	273 633
	3/4"	20.0	9.8	0 - 145	273 635	273 634	273 636	273 637
	1"	20.0	9.8	0 - 145	273 639	273 638	273 640	273 641
	1"	25.0	12.9	0 - 145	TBD	273 642	TBD	TBD
	1 1/4"	25.0	12.9	0 - 145	TBD	273 643	TBD	TBD
	1 1/2"	40.0	35.3	0 - 87	TBD	273 645	TBD	TBD
	2"	40.0	35.3	0 - 87	TBD	273 646	TBD	TBD

DTS 1000314940 EN Version: C Status: RL (released | freigegeben | validé) printed: 10.01.2018

6213 2/2-Way Solenoid Valves, NSF Approved (normally closed, Brass or SS body, 3/8"-1" connection)

Circuit function	Orifice (mm)	Port size	Cv value	Pressure range (PSI)	Body material	Seal material	12/DC	24/DC	24/60	120/60	240/60
<b>A</b> 2/2-way valve NC 	10.0	3/8"	2.2	145	Brass	EPDM	TBD	263 600	287 806	263 597	263 599
					SS	EPDM	TBD	263 609	263 605	263 607	263 608
	13.0	1/2"	4.2	145	Brass	EPDM	TBD	263 613	287 807	263 611	263 612
					SS	EPDM	TBD	263 617	263 614	263 615	263 616
	20.0	3/4"	9.8	145	Brass	EPDM	TBD	263 621	287 808	263 619	263 620
					SS	EPDM	TBD	263 625	263 622	263 623	263 624
20.0	1"	9.8	145	SS	EPDM	TBD	263 630	263 618	263 596	263 610	

6213EV (UL Listed)

Circuit function	(NPT) Port Connection [inch]	Orifice [mm]	CV	Pressure range [PSI]	Item no. per voltage/frequency [V/Hz]			
					24V DC	24/60	120/60	240/60
NC	<b>Brass body, NBR seal</b>							
	1/4"	10.0	1.5	1.5-145	263 095	263 094	*	*
	3/8"	10.0	2.4	1.5-145	280 512	276 336	280 511	276 395
	1/2"	13.0	4.2	1.5-145	280 508	276 337	280 506	276 400
	3/4"	20.0	10.5	1.5-145	280 502	276 385	280 500	276 401
	1"	25.0	12.9	1.5-145	*	*	*	*
	1 1/4"	25.0	12.9	1.5-145	*	*	*	*
	1 1/2"	40.0	35.1	1.5-145	263 106	*	*	*
	2"	40.0	35.1	1.5-145	*	*	*	*
	<b>Brass body, EPDM seal</b>							
	1/4"	10.0	1.5	1.5-145	*	*	*	*
	3/8"	10.0	2.4	1.5-145	268 281	268 289	*	*
	1/2"	13.0	4.2	1.5-145	280 461	276 388	280 458	263 098
	3/4"	20.0	10.5	1.5-145	268 283	276 389	280 456	263 099
	1"	25.0	12.9	1.5-145	*	*	*	*
	1 1/4"	25.0	12.9	1.5-145	*	*	263 101	263 104
	1 1/2"	40.0	35.1	1.5-145	268 285	*	304 833	268 315
	2"	40.0	35.1	1.5-145	*	*	*	*
	<b>Stainless steel body, FKM seal</b>							
	1/4"	10.0	1.5	1.5-145	280 432	*	280 431	*
	3/8"	10.0	2.4	1.5-145	280 426	276 390	280 425	276 404
	1/2"	13.0	4.2	1.5-145	280 420	276 391	280 418	276 405
	3/4"	20.0	10.5	1.5-145	280 415	276 392	280 413	276 406
	1"	25.0	12.9	1.5-145	*	*	*	280 416
	1 1/4"	25.0	12.9	1.5-145	*	*	264 564	*
	1 1/2"	40.0	35.1	1.5-145	*	*	*	*
	2"	40.0	35.1	1.5-145	*	*	*	*
	<b>Stainless steel body, EPDM seal</b>							
	1/4"	10.0	1.5	1.5-145	280 455	*	*	*
	3/8"	10.0	2.4	1.5-145	284 861	*	*	*
	1/2"	13.0	4.2	1.5-145	280 454	*	280 452	264 563
	3/4"	20.0	10.5	1.5-145	*	*	280 451	*
	1"	25.0	12.9	1.5-145	*	*	*	*
1 1/4"	25.0	12.9	1.5-145	*	*	*	*	
1 1/2"	40.0	35.1	1.5-145	*	*	*	*	
2"	40.0	35.1	1.5-145	*	*	*	*	

\*On Request

DTS 1000314940 EN Version: C Status: RL (released | freigegeben | validé) printed: 10.01.2018

## HP00 VERSION (UL Listed)

Circuit function	(NPT) Port Connection [inch]	Orifice [mm]	CV	Pressure range [PSI]	Item no. per voltage/frequency [V/Hz]			
					24V DC	24/60	120/60	240/60
NC	<b>Brass body, FKM seal</b>							
	1/2"	13.0	4.2	1.5-145	*	*	*	*
	3/4"	20.0	10.5	1.5-145	*	*	*	*
	1"	25.0	12.9	1.5-145	*	*	*	*
	<b>Brass body, EPDM seal</b>							
	1/2"	13.0	4.2	1.5-145	*	*	*	*
	3/4"	20.0	10.5	1.5-145	*	*	*	*
	1"	25.0	12.9	1.5-145	*	*	*	*
	<b>Stainless steel body, FKM seal</b>							
	1/2"	13.0	4.2	1.5-145	*	*	*	*
	3/4"	20.0	10.5	1.5-145	*	*	*	*
	1"	25.0	12.9	1.5-145	*	*	*	*
	<b>Stainless steel body, EPDM seal</b>							
	1/2"	13.0	4.2	1.5-145	*	*	*	*
	3/4"	20.0	10.5	1.5-145	*	*	*	*
1"	25.0	12.9	1.5-145	*	*	*	*	

\*On Request

## 6213EV (UL Recognized)

Circuit function	(NPT) Port Connection [inch]	Orifice [mm]	CV	Pressure range [PSI]	Item no. per voltage/frequency [V/Hz]			
					24V DC	24/60	120/60	240/60
NC	<b>Brass body, NBR seal</b>							
	1/4"	10.0	1.5	1.5-145	273 539	273 540	273 541	273 542
	3/8"	10.0	2.4	1.5-145	267 198	267 199	267 200	267 202
	1/2"	13.0	4.2	1.5-145	267 215	273 547	273 548	273 549
	3/4"	20.0	10.5	1.5-145	273 550	273 551	273 552	273 553
	1"	25.0	12.9	1.5-145	267 208	267 209	267 211	267 212
	1 1/4"	25.0	12.9	1.5-145	273 558	*	*	*
	1 1/2"	40.0	35.1	1.5-145	273 559	*	*	*
	2"	40.0	35.1	1.5-145	273 560	*	*	*
	<b>Brass body, FKM seal</b>							
	1/4"	10.0	1.5	1.5-145	273 561	273 562	273 563	273 564
	3/8"	10.0	2.4	1.5-145	273 565	273 566	273 567	273 568
	1/2"	13.0	4.2	1.5-145	273 569	273 570	273 571	273 572
	3/4"	20.0	10.5	1.5-145	273 573	273 574	273 575	273 576
	1"	25.0	12.9	1.5-145	273 581	*	*	*
	1 1/4"	25.0	12.9	1.5-145	273 582	*	*	*
	1 1/2"	40.0	35.1	1.5-145	273 583	*	*	*
	2"	40.0	35.1	1.5-145	273 584	*	*	*
	<b>Brass body, EPDM seal</b>							
	1/4"	10.0	1.5	1.5-145	273 585	273 586	273 587	273 588
	3/8"	10.0	2.4	1.5-145	273 589	273 590	273 591	273 592
	1/2"	13.0	4.2	1.5-145	273 593	273 594	273 595	273 596
	3/4"	20.0	10.5	1.5-145	273 597	273 598	273 599	273 600
	1"	25.0	12.9	1.5-145	273 618	*	*	*
	1 1/4"	25.0	12.9	1.5-145	273 619	*	*	*
	1 1/2"	40.0	35.1	1.5-145	273 620	*	*	*
	2"	40.0	35.1	1.5-145	273 621	*	*	*
	<b>Stainless steel body, FKM seal</b>							
	1/4"	10.0	1.5	1.5-145	273 622	273 623	273 624	273 625
	3/8"	10.0	2.4	1.5-145	273 626	273 627	273 629	273 630
	1/2"	13.0	4.2	1.5-145	273 987	273 631	273 632	273 633
	3/4"	20.0	10.5	1.5-145	273 634	273 635	273 636	273 637
	1"	25.0	12.9	1.5-145	273 642	*	*	*
	1 1/4"	25.0	12.9	1.5-145	273 643	*	*	*
	1 1/2"	40.0	35.1	1.5-145	273 645	*	*	*
	2"	40.0	35.1	1.5-145	273 646	*	*	*
	<b>Stainless steel body, EPDM seal</b>							
	1/4"	10.0	1.5	1.5-145	273 233	273 234	*	*
	3/8"	10.0	2.4	1.5-145	*	273 235	273 236	*
	1/2"	13.0	4.2	1.5-145	273 238	273 240	273 239	*
	3/4"	20.0	10.5	1.5-145	273 251	273 254	282 407	*
	1"	25.0	12.9	1.5-145	*	*	*	*
	1 1/4"	25.0	12.9	1.5-145	*	*	*	*
	1 1/2"	40.0	35.1	1.5-145	*	*	*	*
	2"	40.0	35.1	1.5-145	*	*	*	*

\*On Request



## HP00 VERSION (UL Recognized)

Circuit function	(NPT) Port Connection [inch]	Orifice [mm]	CV	Pressure range [PSI]	Item no. per voltage/frequency [V/Hz]			
					24V DC	24/60	120/60	240/60
NC	<b>Brass body, FKM seal</b>							
	1/2"	13.0	4.2	1.5-145	*	*	*	*
	3/4"	20.0	10.5	1.5-145	*	*	*	*
	1"	25.0	12.9	1.5-145	*	*	*	*
	<b>Brass body, EPDM seal</b>							
	1/2"	13.0	4.2	1.5-145	*	*	*	*
	3/4"	20.0	10.5	1.5-145	*	*	*	*
	1"	25.0	12.9	1.5-145	*	*	*	*
	<b>Stainless steel body, FKM seal</b>							
	1/2"	13.0	4.2	1.5-145	*	*	*	*
	3/4"	20.0	10.5	1.5-145	*	*	*	*
	1"	25.0	12.9	1.5-145	*	*	*	*
	<b>Stainless steel body, EPDM seal</b>							
	1/2"	13.0	4.2	1.5-145	*	*	*	*
	3/4"	20.0	10.5	1.5-145	*	*	*	*
	1"	25.0	12.9	1.5-145	*	*	*	*

\*On Request

## NSF Approved (UL Recognized)

Circuit function	(NPT) Port Connection [inch]	Orifice [mm]	CV	Pressure range [PSI]	Item no. per voltage/frequency [V/Hz]			
					24V DC	24/60	120/60	240/60
NC	<b>Lead free Brass body, EPDM seal</b>							
	3/8"	10.0	2.4	1.5-145	263 600	287 806	263 597	263 599
	1/2"	13.0	4.2	1.5-145	263 613	287 807	263 611	263 612
	3/4"	20.0	10.5	1.5-145	263 621	287 808	263 619	263 620
	1"	20.0	12.9	1.5-145	*	*	*	*
	<b>Stainless steel body, EPDM seal</b>							
	3/8"	10.0	2.4	1.5-145	263 609	263 605	263 607	263 608
	1/2"	13.0	4.2	1.5-145	263 617	263 614	263 615	263 616
	3/4"	20.0	10.5	1.5-145	263 625	263 622	263 623	263 624
	1"	20.0	12.9	1.5-145	263 630	263 618	263 596	263 610

\*On Request

## Ordering chart for valves (other versions on request)

## Valves with brass body

## DN 10-40mm

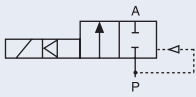
Circuit function	Port connection	Orifice [mm]	Kv value water m <sup>3</sup> /h <sup>1) 4)</sup>	Pressure range [bar] <sup>2)</sup>	Weight [kg] (DC) <sup>3)</sup>	Item no. per voltage/frequency [V/Hz]		
						024/DC	024/50	230/50
A 2/2-way valve NC 	<b>Brass body, NBR Diaphragm, polyamide coil, medium temperature -10...+80°C</b>							
	G 1/4	10	1.3	0 - 10	0.3 (0.5)	221 674	221 675	221 677
	G 3/8	10	1.9	0 - 10	0.3 (0.5)	221 598	221 599	221 601
	G 1/2	10	1.9	0 - 10	0.4 (0.5)	221 606	221 607	221 609
	G 1/2	13	3.6	0 - 10	0.4 (0.5)	221 602	221 603	221 605
	G 3/4	13	3.6	0 - 10	0.5 (0.6)	221 618	221 619	221 621
	G 3/4	20	8.3	0 - 10	0.7 (0.8)	221 630	221 631	221 633
	G 1	20	8.3	0 - 10	0.9 (1.0)	221 634	221 635	221 637
	<b>Brass body, NBR Diaphragm, epoxy coil, medium temperature -10...+80°C</b>							
	G 1	25	11	0 - 10	1.6 (2.2)	227 533	221 725	221 728
	G1 1/4	25	11	0 - 10	1.7 (2.3)	227 534	221 729	221 732
	G1 1/4	40	23	0 - 10	2.9 (3.4)	270 903	270 895	270 899
	G1 1/2	40	30	0 - 10	3.2 (3.7)	227 539	221 750	221 753
	G 2	40	30	0 - 10	3.4 (3.9)	227 541	221 754	221 757
	<b>Brass body, FKM Diaphragm, epoxy coil, medium temperature 0...120°C</b>							
	G 1/4	10	1.3	0 - 10	0.3 (0.5)	221 678	221 679	221 681
	G 3/8	10	1.9	0 - 10	0.3 (0.5)	221 610	221 611	221 613
	G 1/2	10	1.9	0 - 10	0.4 (0.5)	221 614	221 615	221 617
	G 1/2	13	3.6	0 - 10	0.4 (0.5)	221 622	221 623	221 625
	G 3/4	13	3.6	0 - 10	0.5 (0.6)	221 626	221 627	221 629
	G 3/4	20	8.3	0 - 10	0.7 (0.8)	221 638	221 639	221 641
	G 1	20	8.3	0 - 10	0.9 (1.0)	221 642	221 643	221 645
	G 1	25	11	0 - 10	1.6 (2.2)	227 537	221 733	221 736
	G 1 1/4	25	11	0 - 10	1.7 (2.3)	227 538	221 737	221 740
	G 1 1/4	40	23	0 - 10	2.9 (3.4)	270 905	270 906	270 908
	G 1 1/2	40	30	0 - 10	3.2 (3.7)	227 544	227 724	227 726
	G 2	40	30	0 - 10	3.4 (3.9)	227 545	227 728	227 730
	<b>Brass body, EPDM Diaphragm, polyamide coil, medium temperature -30...+90°C</b>							
	G 1/4	10	1.3	0 - 10	0.3 (0.4)	221 670	221 671	221 673
	G 3/8	10	1.9	0 - 10	0.3 (0.4)	221 646	221 647	221 649
	G 1/2	10	1.9	0 - 10	0.4 (0.5)	221 650	221 651	221 653
	G 1/2	13	3.6	0 - 10	0.4 (0.5)	221 654	221 655	221 657
	G 3/4	13	3.6	0 - 10	0.5 (0.6)	221 658	221 659	221 661
G 3/4	20	8.3	0 - 10	0.7 (0.8)	221 662	221 663	221 665	
G 1	20	8.3	0 - 10	0.9 (1.0)	221 666	221 667	221 669	
<b>Brass body, EPDM Diaphragm, epoxy coil, medium temperature -30...+100°C</b>								
G 1	25	11	0 - 10	1.6 (2.2)	227 535	221 717	221 720	
G 1 1/4	25	11	0 - 10	1.7 (2.3)	227 536	221 721	221 724	
G 1 1/4	40	23	0 - 10	2.9 (3.4)	270 904	270 890	270 894	
G 1 1/2	40	30	0 - 10	3.2 (3.7)	227 542	221 741	221 745	
G 2	40	30	0 - 10	3.4 (3.9)	227 543	221 746	221 749	

## DN 13-20 mm HPOO version

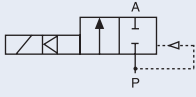
Circuit function	Port connection	Orifice [mm]	Kv value water m <sup>3</sup> /h <sup>1)</sup>	Pressure range [bar] <sup>2)</sup>	Weight [kg] (DC)	Item no. per voltage/frequency [V/Hz]		
						024/DC	024/50	230/50
A 2/2-way valve NC 	<b>Brass-body, FKM Diaphragm, epoxy coil, medium temperature 0...+120°C</b>							
	G 1/2	13	3.6	0 - 10	0.8	221 706	221 705	231 574
	G 3/4	20	8.3	0 - 10	1.3	221 712	221 711	221 713
	G 1	20	8.3	0 - 10	1.4	221 715	221 714	221 716
	<b>Brass-body, EPDM Diaphragm, epoxy coil, medium temperature -30...+100°C</b>							
	G 1/2	13	3.6	0 - 10	0.8	221 694	221 693	221 695
	G 3/4	20	8.3	0 - 10	1.3	208 422	221 699	189 592
	G 1	20	8.3	0 - 10	1.4	221 703	221 702	221 704

<sup>1)</sup> Measured at +20°C, 1 bar<sup>2)</sup> pressure at valve inlet and free outlet

<sup>2)</sup> Pressure data [bar]: Overpressure with respect to atmospheric pressure.

<sup>3)</sup> The values in brackets regarding the weight apply to the DC version.

<sup>4)</sup> A minimum differential pressure of 0.5 bar is required for full (100%) opening.

## Ordering chart for valves (other versions on request)

Valves with Stainless steel body;

DN 10-40 mm

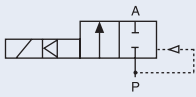
Circuit function	Port connection	Orifice [mm]	Kv value water m <sup>3</sup> /h <sup>1) 4)</sup>	Pressure range [bar] <sup>2)</sup>	Weight [kg] (DC) <sup>3)</sup>	Item no. per voltage/frequency [V/Hz]			
						024/DC	024/50	230/50	
<b>A</b> 2/2-way valve NC 	<b>Stainless steel body, NBR Diaphragm, polyamide coil, medium temperature -10...80°C</b>								
	G 3/8	10	1.9	0 - 10	0.3 (0.4)	222 150	222 151	222 152	
	G 1/2	13	3.6	0 - 10	0.4 (0.5)	222 156	222 157	222 158	
	G 3/4	20	8.3	0 - 10	0.7 (0.8)	222 168	222 169	222 170	
	G 1	20	8.3	0 - 10	0.9 (1.0)	222 171	222 172	222 173	
	<b>Stainless steel body, NBR Diaphragm, epoxy coil, medium temperature -10...80°C</b>								
	G 1	25	11	0 - 10	1.6 (2.2)	227 546	228 429	222 193	
	G 1 1/4	25	11	0 - 10	1.7 (2.3)	227 547	228 432	222 197	
	G 1 1/2	40	30	0 - 10	3.2 (3.7)	227 552	228 435	222 201	
	G 2	40	30	0 - 10	3.4 (3.9)	227 554	228 438	222 205	
	<b>Stainless steel body, FKM Diaphragm, epoxy coil, medium temperature 0...120°C</b>								
	G 3/8	10	1.9	0 - 10	0.3 (0.4)	221 758	221 759	221 761	
	G 1/2	13	3.6	0 - 10	0.4 (0.5)	221 762	221 763	221 765	
	G 3/4	20	8.3	0 - 10	0.7 (0.8)	222 122	222 123	222 125	
	G 1	20	8.3	0 - 10	0.9 (1.0)	222 126	222 127	222 129	
	G 1	25	11	0 - 10	1.6 (2.2)	227 550	228 430	222 143	
	G 1 1/4	25	11	0 - 10	1.7 (2.3)	227 551	228 433	222 145	
	G 1 1/2	40	30	0 - 10	3.2 (3.7)	227 557	228 436	222 147	
	G 2	40	30	0 - 10	3.4 (3.9)	227 558	228 439	222 149	
	<b>Stainless steel body, EPDM Diaphragm, polyamide coil, medium temperature -30...90°C</b>								
	G 3/8	10	1.9	0 - 10	0.3 (0.4)	222 153	222 154	222 155	
	G 1/2	13	3.6	0 - 10	0.4 (0.5)	222 159	222 160	222 161	
	G 3/4	20	8.3	0 - 10	0.7 (0.8)	222 174	222 175	222 176	
	G 1	20	8.3	0 - 10	0.9 (1.0)	222 177	222 178	222 179	
	<b>Stainless steel body, EPDM Diaphragm, epoxy coil, medium temperature -30...+100°C</b>								
	G 1	25	11	0 - 10	1.6 (2.2)	227 548	228 431	222 195	
	G 1 1/4	25	11	0 - 10	1.7 (2.3)	227 549	228 434	222 199	
G 1 1/2	40	30	0 - 10	3.2 (3.7)	227 555	228 437	222 203		
G 2	40	30	0 - 10	3.4 (3.9)	227 556	228 440	222 207		

DN 13-20 mm HPOO version

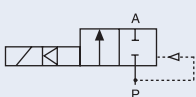
Circuit function	Port connection	Orifice [mm]	Kv value water m <sup>3</sup> /h <sup>1)</sup>	Pressure range [bar] <sup>2)</sup>	Weight [kg] (DC)	Item no. per voltage/frequency [V/Hz]			
						024/DC	024/50	230/50	
<b>A</b> 2/2-way valve NC 	<b>Stainless steel body, FKM Diaphragm, epoxy coil, medium temperature 0...120°C</b>								
	G 1/2	13	3.6	0 - 10	0.8	208 694	220 585	205 351	
	G 3/4	20	8.3	0 - 10	1.3	222 137	222 136	222 138	
	G 1	20	8.3	0 - 10	1.4	222 140	222 139	222 141	
	<b>Stainless steel body, EPDM Diaphragm, epoxy coil, medium temperature -30...100°C</b>								
	G 1/2	13	3.6	0 - 10	0.8	213 132	222 166	220 584	
	G 3/4	20	8.3	0 - 10	1.3	222 186	222 187	222 188	
	G 1	20	8.3	0 - 10	1.4	222 189	222 190	222 191	

<sup>1)</sup> Measured at +20°C, 1 bar <sup>2)</sup> pressure at valve inlet and free outlet<sup>2)</sup> Pressure data [bar]: Overpressure with respect to atmospheric pressure.<sup>3)</sup> The values in brackets regarding the weight apply to the DC version.<sup>4)</sup> A minimum differential pressure of 0.5 bar is required for full (100%) opening.

Please note that the cable plug has to be ordered separately, see Ordering chart for accessory and separate datasheet, Type 2508

**i Further versions on request**

**Port connection**  
NPT, Rc

**Temperature**  
Special temperature ranges

**Voltages**  
Further voltages available

**Body Material**  
Brass dezincification resistant  
nickel-plated brass (5µm)

**Approvals**  
Drinking water approval acc. to KTW/W270  
VDE Approval acc. to DIN EN 60730 (VDE031)  
Watermark Licence  
UL(UL-listed) approval (MH10753)  
UR(UL-recognized) approval  
NEMA 250 Type 4X

**Orifice DN10 in brass and stainless steel is also available in explosion proof version  
Explosion protected approvals**

ATEX: PTB 14 ATEX 2023 X

II 2G Ex mb IIC T4 Gb

II 2D Ex mb IIIC T135°C Db

IECEX: IECEX PTB 14.0049 X

Ex mb IIC T4 Gb

Ex mb IIIC T135°C Db

**Ordering chart for accessory**

**Cable plug Type 2508 according to DIN EN 175301-803 Form A**

	Circuitry	Voltage / frequency	Item no.
	None (standard)	0 - 250 V AC/DC	008 376
further versions see datasheet Type 2508			

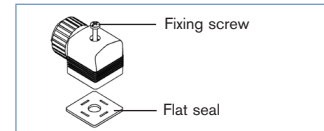

The delivery of a cable plug includes the flat seal and the fixing screw.  
For further versions see datasheet Type 2508.

**Cable plug Type 2513 acc. to DIN EN 175301-803 Form A**

Meets the requirements of ATEX category 3 GD

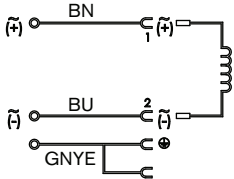
		Cable length [in mm]	Item no. [in mm]
		12000	260 893
5000	260 892		
3000	260 891		
300	260 890		