

# COPPER AND ALUMINUM COMPRESSION LUGS

### Copper Compression Lugs

#### 1-Hole, 2-Hole Lugs

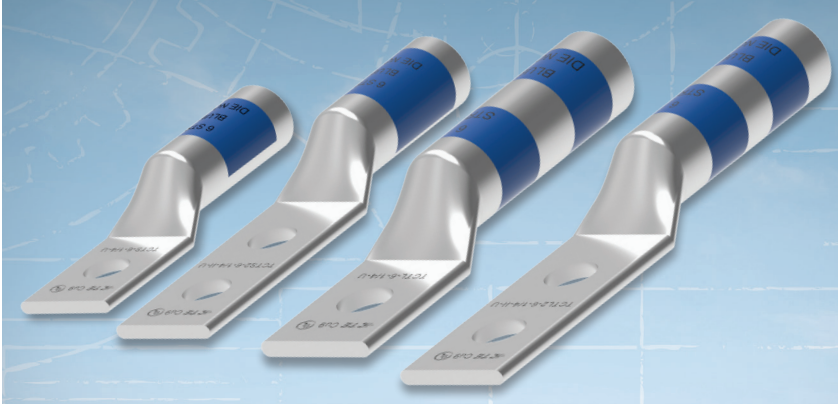

TE's Copper Compression Terminal Connectors are ideal for secondary distribution up to 35 kV. Copper Compression Terminal Connectors are available to accommodate a range of cable sizes from #10 AWG to 1000 kcmil copper and offered in one- or two-hole terminal.

Use for terminating solid, compact and concentric stranded, class B conductors with either a standard or long barrel version and meet the requirements of UL 486.

Compression crimping forms the terminal and conductor into a strong, almost homogeneous unit, producing excellent conductivity, low temperature rise, and outstanding resistance to oxidation and corrosion. Compression of the terminal barrel creates a highly reliable connection that enables connector to perform well and at a lower temperature than the conductor during operation.

#### Key Features

- Easy to install with industry standard tooling
- Industry standard color coding system simplifies die selection
- One-piece, seamless construction from electrolytic tough pitch (ETP) copper for superior electrical performance and mechanical operation
- Closed barrel transition design for protection from moisture and contaminants
- Tin-plated for corrosion resistance and durability, and tempered for easy crimping

## Copper And Aluminum Compression Lugs

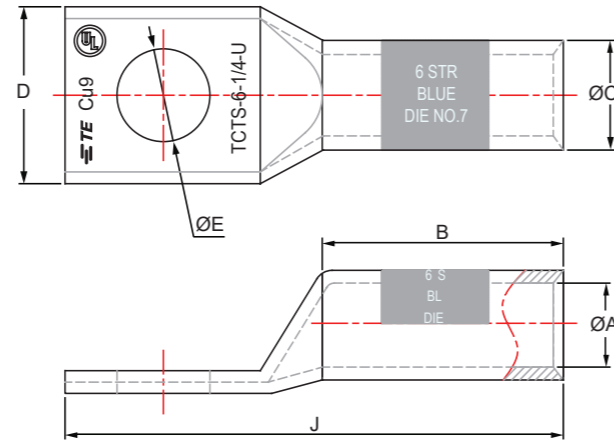
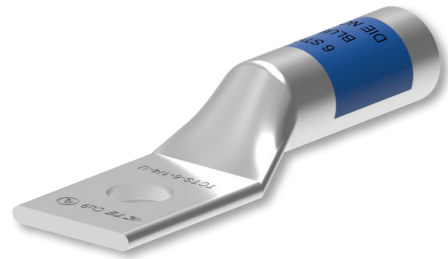

### Copper Compression Lugs with Standard Barrel - One Hole

Description	Conductor AWG/MCM	Dimensions mm (In)					Color Code
		E (Stud Hole)	A (Barrel ID)	B (Barrel Length)	D (Palm Width)	J (Total Length)	
TCTS-10-1/4-U	10	1/4	0.15 (3.8)	0.39(10.0)	0.39 (10.0)	1.10 (27.9)	-
TCTS-8-5/16-U	8	5/16	0.17 (4.4)	0.44(11.2)	0.52 (13.2)	1.38 (35.1)	Red
TCTS-8-1/4-U	8	1/4	0.17 (4.4)	0.44(11.2)	0.44 (11.2)	1.26 (32.0)	Red
TCTS-8-3/8-U	8	3/8	0.17 (4.4)	0.44(11.2)	0.58 (14.7)	1.51 (38.4)	Red
TCTS-6-8-10-U	6	8-10	0.20 (5.0)	0.54(13.7)	0.41 (10.4)	1.18 (30.0)	Blue
TCTS-6-1/4-U	6	1/4	0.20 (5.0)	0.54(13.7)	0.45 (11.4)	1.18 (30.0)	Blue
TCTS-6-5/16-U	6	5/16	0.20 (5.0)	0.54(13.7)	0.52 (13.2)	1.30 (33.0)	Blue
TCTS-6-3/8-U	6	3/8	0.20 (5.0)	0.54(13.7)	0.63 (16.0)	1.30 (33.0)	Blue
TCTS-4-8-10-U	4	8-10	0.25 (6.3)	0.81(20.6)	0.50 (12.7)	1.58 (40.1)	Gray
TCTS-4-1/4-U	4	1/4	0.25 (6.3)	0.81(20.6)	0.50 (12.7)	1.74 (44.2)	Gray
TCTS-4-5/16-U	4	5/16	0.25 (6.3)	0.81(20.6)	0.58 (14.7)	1.92 (48.8)	Gray
TCTS-4-3/8-U	4	3/8	0.25 (6.3)	0.81(20.6)	0.58 (14.7)	1.92 (48.8)	Gray
TCTS-4-1/2-U	4	1/2	0.25 (6.3)	0.81(20.6)	0.71 (18.0)	2.20 (55.9)	Gray
TCTS-2-1/4-U	2	1/4	0.31 (7.8)	0.88 (22.4)	0.61 (15.5)	1.90 (48.3)	Brown
TCTS-2-5/16-U	2	5/16	0.31 (7.8)	0.88 (22.4)	0.61 (15.5)	1.90 (48.3)	Brown
TCTS-2-3/8-U	2	3/8	0.31 (7.8)	0.88 (22.4)	0.61 (15.5)	2.06 (52.3)	Brown
TCTS-2-1/2-U	2	1/2	0.31 (7.8)	0.88 (22.4)	0.73 (18.5)	2.32 (58.9)	Brown
TCTS-1-1/4-U	1	1/4	0.35 (9.0)	0.88 (22.4)	0.68 (17.3)	2.30 (58.4)	Green
TCTS-1-5/16-U	1	5/16	0.35 (9.0)	0.88 (22.4)	0.68 (17.3)	1.90 (48.3)	Green
TCTS-1-3/8-U	1	3/8	0.35 (9.0)	0.88 (22.4)	0.68 (17.3)	2.10 (53.3)	Green
TCTS-1-1/2-U	1	1/2	0.35 (9.0)	0.88 (22.4)	0.73 (18.5)	2.37 (60.2)	Green
TCTS-1/0-1/4-U	1/0	1/4	0.39 (9.9)	0.88 (22.4)	0.75 (19.1)	2.00 (50.8)	Pink
TCTS-1/0-5/16-U	1/0	5/16	0.39 (9.9)	0.88 (22.4)	0.75 (19.1)	2.00 (50.8)	Pink
TCTS-1/0-3/8-U	1/0	3/8	0.39 (9.9)	0.88 (22.4)	0.75 (19.1)	2.09 (53.1)	Pink
TCTS-1/0-1/2-U	1/0	1/2	0.39 (9.9)	0.88 (22.4)	0.75 (19.1)	2.34 (59.4)	Pink
TCTS-2/0-1/4-U	2/0	1/4	0.45 (11.3)	0.94 (23.9)	0.82 (20.8)	1.94 (49.3)	Black
TCTS-2/0-5/16-U	2/0	5/16	0.45 (11.3)	0.94 (23.9)	0.62 (15.7)	2.62 (66.5)	Black
TCTS-2/0-3/8-U	2/0	3/8	0.45 (11.3)	0.94 (23.9)	0.82 (20.8)	2.19 (55.6)	Black
TCTS-2/0-1/2-U	2/0	1/2	0.45 (11.3)	0.94 (23.9)	0.82 (20.8)	2.44 (62.0)	Black
TCTS-2/0-3/4-U	2/0	3/4	0.45 (11.3)	0.94 (23.9)	0.96 (24.4)	2.96 (75.2)	Black
TCTS-3/0-5/16-U	3/0	5/16	0.49 (12.4)	1.00 (25.4)	0.91 (23.1)	2.16 (54.9)	Orange
TCTS-3/0-3/8-U	3/0	3/8	0.49 (12.4)	1.00 (25.4)	0.91 (23.1)	2.30 (58.4)	Orange

## Copper And Aluminum Compression Lugs

### Copper Compression Lugs with Standard Barrel - One Hole

Description	Conductor AWG/MCM	Dimensions mm (In)					Color Code
		E (Stud Hole)	A (Barrel ID)	B (Barrel Length)	D (Palm Width)	J (Total Length)	
TCTS-3/0-1/2-U	3/0	1/2	12.4 (0.49)	25.4 (1.00)	23.1 (0.91)	64.5 (2.54)	Orange
TCTS-4/0-1/4-U	4/0	1/4	14.2 (0.56)	22.4 (0.88)	25.4 (1.00)	50.8 (2.00)	Purple
TCTS-4/0-5/16-U	4/0	5/16	14.2 (0.56)	22.4 (0.88)	25.4 (1.00)	55.9 (2.20)	Purple
TCTS-4/0-3/8-U	4/0	3/8	14.2 (0.56)	22.4 (0.88)	25.4 (1.00)	55.9 (2.20)	Purple
TCTS-4/0-1/2-U	4/0	1/2	14.2 (0.56)	22.4 (0.88)	25.4 (1.00)	62.5 (2.46)	Purple
TCTS-4/0-3/4-U	4/0	3/4	14.2 (0.56)	22.4 (0.88)	26.7 (1.05)	55.9 (2.20)	Purple
TCTS-250-1/4-U	250	1/4	15.1 (0.59)	26.9 (1.06)	27.7 (1.09)	55.9 (2.20)	Yellow
TCTS-250-5/16-U	250	5/16	15.1 (0.59)	26.9 (1.06)	27.7 (1.09)	55.9 (2.20)	Yellow
TCTS-250-3/8-U	250	3/8	15.1 (0.59)	26.9 (1.06)	27.7 (1.09)	61.5 (2.42)	Yellow
TCTS-250-1/2-U	250	1/2	15.1 (0.59)	26.9 (1.06)	27.7 (1.09)	67.8 (2.67)	Yellow
TCTS-300-5/16-U	300	5/16	16.5 (0.65)	26.2 (1.03)	30.5 (1.20)	58.4 (2.30)	White
TCTS-300-3/8-U	300	3/8	16.5 (0.65)	26.2 (1.03)	30.5 (1.20)	58.4 (2.30)	White
TCTS-300-1/2-U	300	1/2	16.5 (0.65)	26.2 (1.03)	30.5 (1.20)	68.6 (2.70)	White
TCTS-300-5/8-U	300	5/8	16.5 (0.65)	26.2 (1.03)	30.5 (1.20)	73.7 (2.90)	White
TCTS-300-7/8-U	300	7/8	16.5 (0.65)	26.2 (1.03)	30.5 (1.20)	86.4 (3.40)	White
TCTS-350-3/8-U	350	3/8	17.8 (0.70)	26.9 (1.06)	32.8 (1.29)	63.5 (2.50)	Red
TCTS-350-1/2-U	350	1/2	17.8 (0.70)	32.8 (1.29)	32.8 (1.29)	69.9 (2.75)	Red
TCTS-350-5/8-U	350	5/8	17.8 (0.70)	32.8 (1.29)	32.8 (1.29)	76.2 (3.00)	Red
TCTS-350-7/8-U	350	7/8	17.8 (0.70)	32.8 (1.29)	32.8 (1.29)	101.6 (4.00)	Red
TCTS-400-3/8-U	400	3/8	19.3 (0.76)	30.2 (1.19)	35.1 (1.38)	68.6 (2.70)	Blue
TCTS-400-1/2-U	400	1/2	19.3 (0.76)	30.2 (1.19)	35.6 (1.40)	74.4 (2.93)	Blue
TCTS-400-5/8-U	400	5/8	19.3 (0.76)	30.2 (1.19)	35.1 (1.38)	81.3 (3.20)	Blue
TCTS-400-7/8-U	400	7/8	19.3 (0.76)	30.2 (1.19)	35.6 (1.40)	91.4 (3.60)	Blue
TCTS-500-3/8-U	500	3/8	21.1 (0.83)	32.3 (1.27)	39.1 (1.54)	73.7 (2.90)	Brown
TCTS-500-1/2-U	500	1/2	21.1 (0.83)	32.3 (1.27)	39.1 (1.54)	79.2 (3.12)	Brown
TCTS-500-5/8-U	500	5/8	21.1 (0.83)	32.3 (1.27)	39.1 (1.54)	86.4 (3.40)	Brown
TCTS-500-3/4-U	500	3/4	21.1 (0.83)	32.3 (1.27)	39.1 (1.54)	91.4 (3.60)	Brown
TCTS-500-7/8-U	500	7/8	21.1 (0.83)	32.3 (1.27)	39.1 (1.54)	96.5 (3.80)	Brown
TCTS-600-1/2-U	600	1/2	23.4 (0.92)	35.1 (1.38)	43.4 (1.71)	83.8 (3.30)	Green
TCTS-600-5/8-U	600	5/8	23.4 (0.92)	35.1 (1.38)	43.4 (1.71)	94.0 (3.70)	Green
TCTS-750-1/2-U	750	1/2	26.2 (1.03)	36.1 (1.42)	48.0 (1.89)	86.6 (3.41)	Black
TCTS-750-5/8-U	750	5/8	26.2 (1.03)	36.1 (1.42)	48.0 (1.89)	93.2 (3.67)	Black
TCTS-750-7/8-U	750	7/8	26.2 (1.03)	36.1 (1.42)	48.0 (1.89)	104.1 (4.10)	Black
TCTS-1000-1/2-U	1000	1/2	29.7 (1.17)	41.9 (1.65)	55.6 (2.19)	101.6 (4.00)	White
TCTS-1000-5/8-U	1000	5/8	29.7 (1.17)	41.9 (1.65)	55.6 (2.19)	101.6 (4.00)	White
TCTS-1000-1-U	1000	1.0	29.7 (1.17)	41.9 (1.65)	55.6 (2.19)	120.1 (4.73)	White



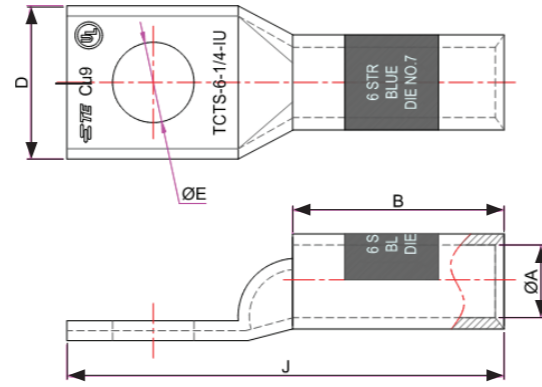

Copper Compression Lugs with Standard Barrel - One Hole (with inspection window)

Description	Conductor AWG/MCM	Dimensions mm (In)					Color Code
		E (Stud Hole)	A (Barrel ID)	B (Barrel Length)	D (Palm Width)	J (Total Length)	
TCTS-10-1/4-IU	10	1/4	0.15 (3.8)	0.39(10.0)	0.39 (10.0)	1.10 (27.9)	-
TCTS-8-5/16-IU	8	5/16	0.17 (4.4)	0.44(11.2)	0.52 (13.2)	1.38 (35.1)	Red
TCTS-8-1/4-IU	8	1/4	0.17 (4.4)	0.44(11.2)	0.44 (11.2)	1.26 (32.0)	Red
TCTS-8-3/8-IU	8	3/8	0.17 (4.4)	0.44(11.2)	0.58 (14.7)	1.51 (38.4)	Red
TCTS-6-8-10-IU	6	8-10	0.20 (5.0)	0.54(13.7)	0.41 (10.4)	1.18 (30.0)	Blue
TCTS-6-1/4-IU	6	1/4	0.20 (5.0)	0.54(13.7)	0.45 (11.4)	1.18 (30.0)	Blue
TCTS-6-5/16-IU	6	5/16	0.20 (5.0)	0.54(13.7)	0.52 (13.2)	1.30 (33.0)	Blue
TCTS-6-3/8-IU	6	3/8	0.20 (5.0)	0.54(13.7)	0.63 (16.0)	1.30 (33.0)	Blue
TCTS-4-8-10-IU	4	8-10	0.25 (6.3)	0.81(20.6)	0.50 (12.7)	1.58 (40.1)	Gray
TCTS-4-1/4-IU	4	1/4	0.25 (6.3)	0.81(20.6)	0.50 (12.7)	1.74 (44.2)	Gray
TCTS-4-5/16-IU	4	5/16	0.25 (6.3)	0.81(20.6)	0.58 (14.7)	1.92 (48.8)	Gray
TCTS-4-3/8-IU	4	3/8	0.25 (6.3)	0.81(20.6)	0.58 (14.7)	1.92 (48.8)	Gray
TCTS-4-1/2-IU	4	1/2	0.25 (6.3)	0.81(20.6)	0.71 (18.0)	2.20 (55.9)	Gray
TCTS-2-1/4-IU	2	1/4	0.31 (7.8)	0.88 (22.4)	0.61 (15.5)	1.90 (48.3)	Brown
TCTS-2-5/16-IU	2	5/16	0.31 (7.8)	0.88 (22.4)	0.61 (15.5)	1.90 (48.3)	Brown
TCTS-2-3/8-IU	2	3/8	0.31 (7.8)	0.88 (22.4)	0.61 (15.5)	2.06 (52.3)	Brown
TCTS-2-1/2-IU	2	1/2	0.31 (7.8)	0.88 (22.4)	0.73 (18.5)	2.32 (58.9)	Brown
TCTS-1-1/4-IU	1	1/4	0.35 (9.0)	0.88 (22.4)	0.68 (17.3)	2.30 (58.4)	Green
TCTS-1-5/16-IU	1	5/16	0.35 (9.0)	0.88 (22.4)	0.68 (17.3)	1.90 (48.3)	Green
TCTS-1-3/8-IU	1	3/8	0.35 (9.0)	0.88 (22.4)	0.68 (17.3)	2.10 (53.3)	Green
TCTS-1-1/2-IU	1	1/2	0.35 (9.0)	0.88 (22.4)	0.73 (18.5)	2.37 (60.2)	Green
TCTS-1/0-1/4-IU	1/0	1/4	0.39 (9.9)	0.88 (22.4)	0.75 (19.1)	2.00 (50.8)	Pink
TCTS-1/0-5/16-IU	1/0	5/16	0.39 (9.9)	0.88 (22.4)	0.75 (19.1)	2.00 (50.8)	Pink
TCTS-1/0-3/8-IU	1/0	3/8	0.39 (9.9)	0.88 (22.4)	0.75 (19.1)	2.09 (53.1)	Pink
TCTS-1/0-1/2-IU	1/0	1/2	0.39 (9.9)	0.88 (22.4)	0.75 (19.1)	2.34 (59.4)	Pink
TCTS-2/0-1/4-IU	2/0	1/4	0.45 (11.3)	0.94 (23.9)	0.82 (20.8)	1.94 (49.3)	Black
TCTS-2/0-5/16-IU	2/0	5/16	0.45 (11.3)	0.94 (23.9)	0.62 (15.7)	2.62 (66.5)	Black
TCTS-2/0-3/8-IU	2/0	3/8	0.45 (11.3)	0.94 (23.9)	0.82 (20.8)	2.19 (55.6)	Black
TCTS-2/0-1/2-IU	2/0	1/2	0.45 (11.3)	0.94 (23.9)	0.82 (20.8)	2.44 (62.0)	Black
TCTS-2/0-3/4-IU	2/0	3/4	0.45 (11.3)	0.94 (23.9)	0.96 (24.4)	2.96 (75.2)	Black
TCTS-3/0-5/16-IU	3/0	5/16	0.49 (12.4)	1.00 (25.4)	0.91 (23.1)	2.16 (54.9)	Orange
TCTS-3/0-3/8-IU	3/0	3/8	0.49 (12.4)	1.00 (25.4)	0.91 (23.1)	2.30 (58.4)	Orange

Copper Compression Lugs with Standard Barrel - One Hole (with inspection window)

Description	Conductor AWG/MCM	Dimensions mm (In)					Color Code
		E (Stud Hole)	A (Barrel ID)	B (Barrel Length)	D (Palm Width)	J (Total Length)	
TCTS-3/0-1/2-IU	3/0	1/2	12.4 (0.49)	25.4 (1.00)	23.1 (0.91)	64.5 (2.54)	Orange
TCTS-4/0-1/4-IU	4/0	1/4	14.2 (0.56)	22.4 (0.88)	25.4 (1.00)	50.8 (2.00)	Purple
TCTS-4/0-5/16-IU	4/0	5/16	14.2 (0.56)	22.4 (0.88)	25.4 (1.00)	55.9 (2.20)	Purple
TCTS-4/0-3/8-IU	4/0	3/8	14.2 (0.56)	22.4 (0.88)	25.4 (1.00)	55.9 (2.20)	Purple
TCTS-4/0-1/2-IU	4/0	1/2	14.2 (0.56)	22.4 (0.88)	25.4 (1.00)	62.5 (2.46)	Purple
TCTS-4/0-3/4-IU	4/0	3/4	14.2 (0.56)	22.4 (0.88)	26.7 (1.05)	55.9 (2.20)	Purple
TCTS-250-1/4-IU	250	1/4	15.1 (0.59)	26.9 (1.06)	27.7 (1.09)	55.9 (2.20)	Yellow
TCTS-250-5/16-IU	250	5/16	15.1 (0.59)	26.9 (1.06)	27.7 (1.09)	55.9 (2.20)	Yellow
TCTS-250-3/8-IU	250	3/8	15.1 (0.59)	26.9 (1.06)	27.7 (1.09)	61.5 (2.42)	Yellow
TCTS-250-1/2-IU	250	1/2	15.1 (0.59)	26.9 (1.06)	27.7 (1.09)	67.8 (2.67)	Yellow
TCTS-300-5/16-IU	300	5/16	16.5 (0.65)	26.2 (1.03)	30.5 (1.20)	58.4 (2.30)	White
TCTS-300-3/8-IU	300	3/8	16.5 (0.65)	26.2 (1.03)	30.5 (1.20)	58.4 (2.30)	White
TCTS-300-1/2-IU	300	1/2	16.5 (0.65)	26.2 (1.03)	30.5 (1.20)	68.6 (2.70)	White
TCTS-300-5/8-IU	300	5/8	16.5 (0.65)	26.2 (1.03)	30.5 (1.20)	73.7 (2.90)	White
TCTS-300-7/8-IU	300	7/8	16.5 (0.65)	26.2 (1.03)	30.5 (1.20)	86.4 (3.40)	White
TCTS-350-3/8-IU	350	3/8	17.8 (0.70)	26.9 (1.06)	32.8 (1.29)	63.5 (2.50)	Red
TCTS-350-1/2-IU	350	1/2	17.8 (0.70)	32.8 (1.29)	32.8 (1.29)	69.9 (2.75)	Red
TCTS-350-5/8-IU	350	5/8	17.8 (0.70)	32.8 (1.29)	32.8 (1.29)	76.2 (3.00)	Red
TCTS-350-7/8-IU	350	7/8	17.8 (0.70)	32.8 (1.29)	32.8 (1.29)	101.6 (4.00)	Red
TCTS-400-3/8-IU	400	3/8	19.3 (0.76)	30.2 (1.19)	35.1 (1.38)	68.6 (2.70)	Blue
TCTS-400-1/2-IU	400	1/2	19.3 (0.76)	30.2 (1.19)	35.6 (1.40)	74.4 (2.93)	Blue
TCTS-400-5/8-IU	400	5/8	19.3 (0.76)	30.2 (1.19)	35.1 (1.38)	81.3 (3.20)	Blue
TCTS-400-7/8-IU	400	7/8	19.3 (0.76)	30.2 (1.19)	35.6 (1.40)	91.4 (3.60)	Blue
TCTS-500-3/8-IU	500	3/8	21.1 (0.83)	32.3 (1.27)	39.1 (1.54)	73.7 (2.90)	Brown
TCTS-500-1/2-IU	500	1/2	21.1 (0.83)	32.3 (1.27)	39.1 (1.54)	79.2 (3.12)	Brown
TCTS-500-5/8-IU	500	5/8	21.1 (0.83)	32.3 (1.27)	39.1 (1.54)	86.4 (3.40)	Brown
TCTS-500-3/4-IU	500	3/4	21.1 (0.83)	32.3 (1.27)	39.1 (1.54)	91.4 (3.60)	Brown
TCTS-500-7/8-IU	500	7/8	21.1 (0.83)	32.3 (1.27)	39.1 (1.54)	96.5 (3.80)	Brown
TCTS-600-1/2-IU	600	1/2	23.4 (0.92)	35.1 (1.38)	43.4 (1.71)	83.8 (3.30)	Green
TCTS-600-5/8-IU	600	5/8	23.4 (0.92)	35.1 (1.38)	43.4 (1.71)	94.0 (3.70)	Green
TCTS-750-1/2-IU	750	1/2	26.2 (1.03)	36.1 (1.42)	48.0 (1.89)	86.6 (3.41)	Black
TCTS-750-5/8-IU	750	5/8	26.2 (1.03)	36.1 (1.42)	48.0 (1.89)	93.2 (3.67)	Black
TCTS-750-7/8-IU	750	7/8	26.2 (1.03)	36.1 (1.42)	48.0 (1.89)	104.1 (4.10)	Black
TCTS-1000-1/2-IU	1000	1/2	29.7 (1.17)	41.9 (1.65)	55.6 (2.19)	101.6 (4.00)	White
TCTS-1000-5/8-IU	1000	5/8	29.7 (1.17)	41.9 (1.65)	55.6 (2.19)	101.6 (4.00)	White
TCTS-1000-1-IU	1000	1.0	29.7 (1.17)	41.9 (1.65)	55.6 (2.19)	120.1 (4.73)	White



## Copper And Aluminum Compression Lugs

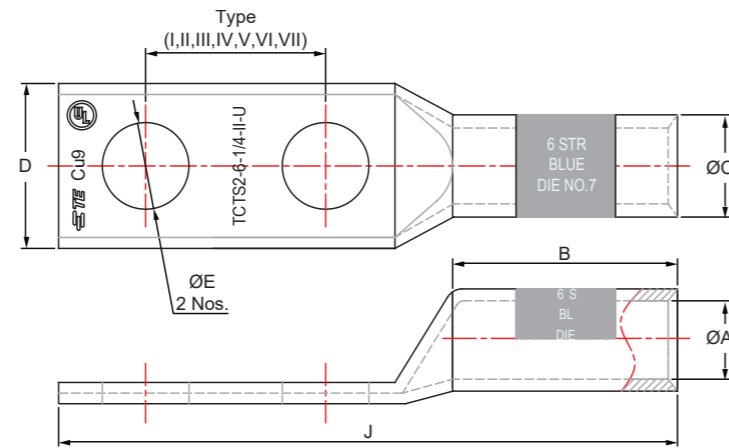
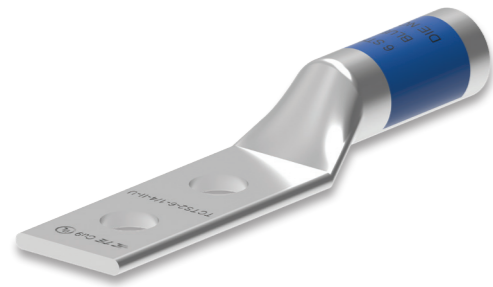

### Copper Compression Lugs with Standard Barrel - Two Holes

Description	Conductor AWG/MCM	Dimensions mm (In)							Color Code
		E (Stud Hole)	Stud Hole Spacing	Type	A (Barrel ID)	B (Barrel Length)	D (Palm Width)	J (Total Length)	
TCTS2-8-10-I-U	8	#10	0.63 (15.9)	I	4.4 (0.17)	11.2 (0.44)	11.2 (0.44)	50.0 (1.97)	Red
TCTS2-8-1/4-I-U	8	1/4	0.63 (15.9)	I	4.4 (0.17)	11.2 (0.44)	11.2 (0.44)	50.0 (1.97)	Red
TCTS2-8-1/4-III-U	8	1/4	1.00 (25.4)	III	4.4 (0.17)	11.2 (0.44)	11.2 (0.44)	61.0 (2.40)	Red
TCTS2-8-1/4-II-U	8	1/4	0.75 (19.1)	II	4.4 (0.17)	11.2 (0.44)	11.2 (0.44)	53.2 (2.09)	Red
TCTS2-8-3/8-III-U	8	3/8	1.00 (25.4)	III	4.4 (0.17)	11.2 (0.44)	14.7 (0.58)	61.0 (2.40)	Red
TCTS2-6-10-I-U	6	#10	0.63 (15.9)	I	5.0 (0.20)	13.7 (0.54)	11.4 (0.45)	54.0 (2.13)	Blue
TCTS2-6-1/4-I-U	6	1/4	0.63 (15.9)	I	5.0 (0.20)	13.7 (0.54)	11.4 (0.45)	54.0 (2.13)	Blue
TCTS2-6-1/4-III-U	6	1/4	1.00 (25.4)	III	5.0 (0.20)	13.7 (0.54)	11.4 (0.45)	64.0 (2.52)	Blue
TCTS2-6-1/4-V-U	6	1/4	0.50 (12.7)	V	5.0 (0.20)	13.7 (0.54)	11.4 (0.45)	51.0 (2.01)	Blue
TCTS2-6-1/4-II-U	6	1/4	0.75 (19.1)	II	5.0 (0.20)	13.7 (0.54)	11.4 (0.45)	57.0 (2.24)	Blue
TCTS2-6-5/16-III-U	6	5/16	1.00 (25.4)	III	5.0 (0.20)	13.7 (0.54)	13.2 (0.52)	68.5 (2.70)	Blue
TCTS2-6-3/8-III-U	6	3/8	1.00 (25.4)	III	5.0 (0.20)	13.7 (0.54)	16.0 (0.63)	68.5 (2.70)	Blue
TCTS2-4-1/4-I-U	4	1/4	0.63 (15.9)	I	6.3 (0.25)	20.6 (0.81)	12.7 (0.50)	62.0 (2.44)	Gray
TCTS2-4-1/4-II-U	4	1/4	0.75 (19.1)	II	6.3 (0.25)	20.6 (0.81)	12.7 (0.50)	65.0 (2.56)	Gray
TCTS2-4-1/4-III-U	4	1/4	1.00 (25.4)	III	6.3 (0.25)	20.6 (0.81)	12.7 (0.50)	71.5 (2.81)	Gray
TCTS2-4-3/8-III-U	4	3/8	1.00 (25.4)	III	6.3 (0.25)	20.6 (0.81)	14.7 (0.58)	76.0 (2.99)	Gray
TCTS2-2-1/4-I-U	2	1/4	0.63 (15.9)	I	7.8 (0.31)	22.4 (0.88)	15.5 (0.61)	69.0 (2.72)	Brown
TCTS2-2-1/4-II-U	2	1/4	0.75 (19.1)	II	7.8 (0.31)	22.4 (0.88)	15.5 (0.61)	73.0 (2.87)	Brown
TCTS2-2-1/4-III-U	2	1/4	1.00 (25.4)	III	7.8 (0.31)	22.4 (0.88)	15.5 (0.61)	80.0 (3.15)	Brown
TCTS2-2-5/16-II-U	2	5/16	0.75 (19.1)	II	7.8 (0.31)	22.4 (0.88)	15.5 (0.61)	74.0 (2.91)	Brown
TCTS2-2-5/16-III-U	2	5/16	1.00 (25.4)	III	7.8 (0.31)	22.4 (0.88)	15.5 (0.61)	80.0 (3.15)	Brown
TCTS2-2-3/8-III-U	2	3/8	1.00 (25.4)	III	7.8 (0.31)	22.4 (0.88)	15.5 (0.61)	80.0 (3.15)	Brown
TCTS2-2-1/2-IV-U	2	1/2	0.75 (19.1)	IV	7.8 (0.31)	22.4 (0.88)	18.5 (0.73)	100.0 (3.94)	Brown
TCTS2-1-1/4-I-U	1	1/4	0.63 (15.9)	I	9.0 (0.35)	22.4 (0.88)	17.3 (0.68)	83.0 (3.27)	Green
TCTS2-1-1/4-II-U	1	1/4	0.75 (19.1)	II	9.0 (0.35)	22.4 (0.88)	17.3 (0.68)	85.0 (3.35)	Green
TCTS2-1-5/16-VI-U	1	5/16	0.87 (22.2)	VI	9.0 (0.35)	22.4 (0.88)	17.3 (0.68)	89.0 (3.50)	Green
TCTS2-1-3/8-III-U	1	3/8	1.00 (25.4)	III	9.0 (0.35)	22.4 (0.88)	17.3 (0.68)	91.0 (3.58)	Green
TCTS2-1-1/2-IV-U	1	1/2	0.75 (19.1)	IV	9.0 (0.35)	22.4 (0.88)	18.5 (0.73)	11.0 (4.37)	Green
TCTS2-1/0-1/4-I-U	1/0	1/4	0.63 (15.9)	I	9.9 (0.39)	22.4 (0.88)	19.1 (0.75)	82.0 (3.23)	Pink
TCTS2-1/0-1/4-II-U	1/0	1/4	0.75 (19.1)	II	9.9 (0.39)	22.4 (0.88)	19.1 (0.75)	85.5 (3.37)	Pink

## Copper And Aluminum Compression Lugs

### Copper Compression Lugs with Standard Barrel - Two Holes

Description	Conductor AWG/MCM	Dimensions mm (In)							Color Code
		E (Stud Hole)	Stud Hole Spacing	Type	A (Barrel ID)	B (Barrel Length)	D (Palm Width)	J (Total Length)	
TCTS2-1/0-5/16-VI-U	1/0	5/16	0.87 (22.2)	VI	9.9 (0.39)	22.4 (0.88)	19.1 (0.75)	88.5 (3.48)	Pink
TCTS2-1/0-3/8-III-U	1/0	3/8	1.00 (25.4)	III	9.9 (0.39)	22.4 (0.88)	19.1 (0.75)	91.5 (3.6)	Pink
TCTS2-1/0-1/2-IV-U	1/0	1/2	0.75 (19.1)	IV	9.9 (0.39)	22.4 (0.88)	19.1 (0.75)	110.5 (4.35)	Pink
TCTS2-2/0-1/4-I-U	2/0	1/4	0.63 (15.9)	I	11.3 (0.45)	23.9 (0.94)	20.8 (0.82)	85.0 (3.35)	Black
TCTS2-2/0-1/4-II-U	2/0	1/4	0.75 (19.1)	II	11.3 (0.45)	23.9 (0.94)	20.8 (0.82)	88.0 (3.46)	Black
TCTS2-2/0-5/16-VI-U	2/0	5/16	0.87 (22.2)	VI	11.3 (0.45)	23.9 (0.94)	15.7 (0.62)	91.0 (3.58)	Black
TCTS2-2/0-3/8-III-U	2/0	3/8	1.00 (25.4)	III	11.3 (0.45)	23.9 (0.94)	20.8 (0.82)	94.0 (3.7)	Black
TCTS2-2/0-1/2-IV-U	2/0	1/2	1.75 (44.5)	IV	11.3 (0.45)	23.9 (0.94)	20.8 (0.82)	113.2 (4.46)	Black
TCTS2-3/0-1/4-II-U	3/0	1/4	0.75 (19.1)	II	12.4 (0.49)	25.4 (1.00)	23.1 (0.91)	91.2 (3.59)	Orange
TCTS2-3/0-5/16-III-U	3/0	5/16	1.00 (25.4)	III	12.4 (0.49)	25.4 (1.00)	23.1 (0.91)	97.5 (3.84)	Orange
TCTS2-3/0-3/8-III-U	3/0	3/8	1.00 (25.4)	III	12.4 (0.49)	25.4 (1.00)	23.1 (0.91)	97.5 (3.84)	Orange
TCTS2-3/0-1/2-IV-U	3/0	1/2	1.75 (44.5)	IV	12.4 (0.49)	25.4 (1.00)	23.1 (0.91)	116.7 (4.59)	Orange
TCTS2-4/0-1/4-II-U	4/0	1/4	0.75 (19.1)	II	14.2 (0.56)	22.4 (0.88)	25.4 (1.00)	89.0 (3.5)	Purple
TCTS2-4/0-1/4-III-U	4/0	1/4	1.00 (25.4)	III	14.2 (0.56)	22.4 (0.88)	25.4 (1.00)	95.5 (3.76)	Purple
TCTS2-4/0-3/8-III-U	4/0	3/8	1.00 (25.4)	III	14.2 (0.56)	22.4 (0.88)	25.4 (1.00)	95.5 (3.76)	Purple
TCTS2-4/0-1/2-IV-U	4/0	1/2	1.75 (44.5)	IV	14.2 (0.56)	22.4 (0.88)	25.4 (1.00)	115.0 (4.53)	Purple
TCTS2-250-3/8-III-U	250	3/8	1.00 (25.4)	III	15.1 (0.59)	26.9 (1.06)	27.7 (1.09)	102.0 (4.02)	Yellow
TCTS2-250-1/2-IV-U	250	1/2	1.75 (44.5)	IV	15.1 (0.59)	26.9 (1.06)	27.7 (1.09)	121.0 (4.76)	Yellow
TCTS2-300-3/8-III-U	300	3/8	1.00 (25.4)	III	16.5 (0.65)	26.2 (1.03)	30.5 (1.20)	102.0 (4.02)	White
TCTS2-300-1/2-IV-U	300	1/2	1.75 (44.5)	IV	16.5 (0.65)	26.2 (1.03)	30.5 (1.20)	121.0 (4.76)	White
TCTS2-350-1/4-II-U	350	1/4	0.75 (19.1)	II	17.8 (0.7)	26.9 (1.06)	32.8 (1.29)	95.0 (3.74)	Red
TCTS2-350-3/8-III-U	350	3/8	1.00 (25.4)	III	17.8 (0.7)	26.9 (1.06)	32.8 (1.29)	102.0 (4.02)	Red
TCTS2-350-1/2-VII-U	350	1/2	1.25 (31.8)	VII	17.8 (0.7)	32.8 (1.29)	32.8 (1.29)	115.0 (4.53)	Red
TCTS2-350-1/2-IV-U	350	1/2	1.75 (44.5)	IV	17.8 (0.7)	32.8 (1.29)	32.8 (1.29)	128.0 (5.04)	Red
TCTS2-400-3/8-III-U	400	3/8	1.00 (25.4)	III	19.3 (0.76)	30.2 (1.19)	35.1 (1.38)	108.0 (4.25)	Blue
TCTS2-400-1/2-IV-U	400	1/2	1.75 (44.5)	IV	19.3 (0.76)	30.2 (1.19)	35.6 (1.40)	128.0 (5.04)	Blue
TCTS2-500-1/4-II-U	500	1/4	0.75 (19.1)	II	21.1 (0.83)	32.3 (1.27)	39.1 (1.54)	102.0 (4.02)	Brown
TCTS2-500-3/8-III-U	500	3/8	1.00 (25.4)	III	21.1 (0.83)	32.3 (1.27)	39.1 (1.54)	110.0 (4.33)	Brown
TCTS2-500-1/2-IV-U	500	1/2	1.75 (44.5)	IV	21.1 (0.83)	32.3 (1.27)	39.1 (1.54)	129.0 (5.08)	Brown
TCTS2-600-3/8-III-U	600	3/8	1.00 (25.4)	III	23.4 (0.92)	35.1 (1.38)	43.4 (1.71)	117.0 (4.61)	Green
TCTS2-600-1/2-IV-U	600	1/2	1.75 (44.5)	IV	23.4 (0.92)	35.1 (1.38)	43.4 (1.71)	135.0 (5.31)	Green
TCTS2-750-3/8-III-U	750	3/8	1.00 (25.4)	III	26.2 (1.03)	36.1 (1.42)	48.0 (1.89)	118.0 (4.65)	Black
TCTS2-750-1/2-IV-U	750	1/2	1.75 (44.5)	IV	26.2 (1.03)	36.1 (1.42)	48.0 (1.89)	137.0 (5.39)	Black
TCTS2-1000-1/2-VII-U	1000	1/2	1.25 (31.8)	VII	29.7 (1.17)	41.9 (1.65)	55.6 (2.19)	133.0 (5.24)	White
TCTS2-1000-1/2-IV-U	1000	1/2	1.75 (44.5)	IV	29.7 (1.17)	41.9 (1.65)	55.6 (2.19)	147.0 (5.79)	White



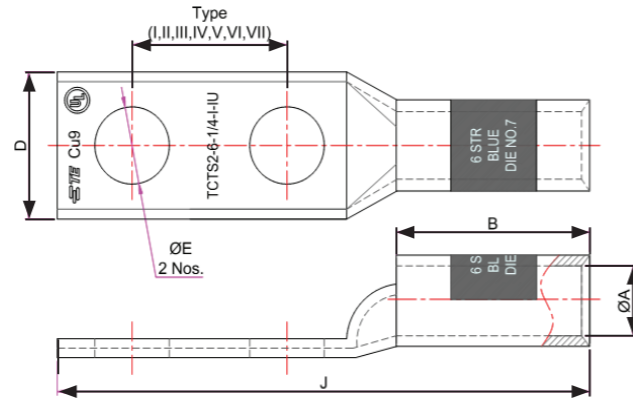

Copper Compression Lugs with Standard Barrel - Two Holes (with inspection window)

Description	Conductor AWG/MCM	Dimensions mm (In)							Color Code
		E (Stud Hole)	Stud Hole Spacing	Type	A (Barrel ID)	B (Barrel Length)	D (Palm Width)	J (Total Length)	
TCTS2-8-10-I-U	8	#10	0.63 (15.9)	I	4.4 (0.17)	11.2 (0.44)	11.2 (0.44)	50.0 (1.97)	Red
TCTS2-8-1/4-I-U	8	1/4	0.63 (15.9)	I	4.4 (0.17)	11.2 (0.44)	11.2 (0.44)	50.0 (1.97)	Red
TCTS2-8-1/4-III-U	8	1/4	1.00 (25.4)	III	4.4 (0.17)	11.2 (0.44)	11.2 (0.44)	61.0 (2.40)	Red
TCTS2-8-1/4-II-U	8	1/4	0.75 (19.1)	II	4.4 (0.17)	11.2 (0.44)	11.2 (0.44)	53.2 (2.09)	Red
TCTS2-8-3/8-III-U	8	3/8	1.00 (25.4)	III	4.4 (0.17)	11.2 (0.44)	14.7 (0.58)	61.0 (2.40)	Red
TCTS2-6-10-I-U	6	#10	0.63 (15.9)	I	5.0 (0.20)	13.7 (0.54)	11.4 (0.45)	54.0 (2.13)	Blue
TCTS2-6-1/4-I-U	6	1/4	0.63 (15.9)	I	5.0 (0.20)	13.7 (0.54)	11.4 (0.45)	54.0 (2.13)	Blue
TCTS2-6-1/4-III-U	6	1/4	1.00 (25.4)	III	5.0 (0.20)	13.7 (0.54)	11.4 (0.45)	64.0 (2.52)	Blue
TCTS2-6-1/4-V-U	6	1/4	0.50 (12.7)	V	5.0 (0.20)	13.7 (0.54)	11.4 (0.45)	51.0 (2.01)	Blue
TCTS2-6-1/4-II-U	6	1/4	0.75 (19.1)	II	5.0 (0.20)	13.7 (0.54)	11.4 (0.45)	57.0 (2.24)	Blue
TCTS2-6-5/16-III-U	6	5/16	1.00 (25.4)	III	5.0 (0.20)	13.7 (0.54)	13.2 (0.52)	68.5 (2.70)	Blue
TCTS2-6-3/8-III-U	6	3/8	1.00 (25.4)	III	5.0 (0.20)	13.7 (0.54)	16.0 (0.63)	68.5 (2.70)	Blue
TCTS2-4-1/4-I-U	4	1/4	0.63 (15.9)	I	6.3 (0.25)	20.6 (0.81)	12.7 (0.50)	62.0 (2.44)	Gray
TCTS2-4-1/4-II-U	4	1/4	0.75 (19.1)	II	6.3 (0.25)	20.6 (0.81)	12.7 (0.50)	65.0 (2.56)	Gray
TCTS2-4-1/4-III-U	4	1/4	1.00 (25.4)	III	6.3 (0.25)	20.6 (0.81)	12.7 (0.50)	71.5 (2.81)	Gray
TCTS2-4-3/8-III-U	4	3/8	1.00 (25.4)	III	6.3 (0.25)	20.6 (0.81)	14.7 (0.58)	76.0 (2.99)	Gray
TCTS2-2-1/4-I-U	2	1/4	0.63 (15.9)	I	7.8 (0.31)	22.4 (0.88)	15.5 (0.61)	69.0 (2.72)	Brown
TCTS2-2-1/4-II-U	2	1/4	0.75 (19.1)	II	7.8 (0.31)	22.4 (0.88)	15.5 (0.61)	73.0 (2.87)	Brown
TCTS2-2-1/4-III-U	2	1/4	1.00 (25.4)	III	7.8 (0.31)	22.4 (0.88)	15.5 (0.61)	80.0 (3.15)	Brown
TCTS2-2-5/16-II-U	2	5/16	0.75 (19.1)	II	7.8 (0.31)	22.4 (0.88)	15.5 (0.61)	74.0 (2.91)	Brown
TCTS2-2-5/16-III-U	2	5/16	1.00 (25.4)	III	7.8 (0.31)	22.4 (0.88)	15.5 (0.61)	80.0 (3.15)	Brown
TCTS2-2-3/8-III-U	2	3/8	1.00 (25.4)	III	7.8 (0.31)	22.4 (0.88)	15.5 (0.61)	80.0 (3.15)	Brown
TCTS2-2-1/2-IV-U	2	1/2	0.75 (19.1)	IV	7.8 (0.31)	22.4 (0.88)	18.5 (0.73)	100.0 (3.94)	Brown
TCTS2-1-1/4-I-U	1	1/4	0.63 (15.9)	I	9.0 (0.35)	22.4 (0.88)	17.3 (0.68)	83.0 (3.27)	Green
TCTS2-1-1/4-II-U	1	1/4	0.75 (19.1)	II	9.0 (0.35)	22.4 (0.88)	17.3 (0.68)	85.0 (3.35)	Green
TCTS2-1-5/16-VI-U	1	5/16	0.87 (22.2)	VI	9.0 (0.35)	22.4 (0.88)	17.3 (0.68)	89.0 (3.50)	Green
TCTS2-1-3/8-III-U	1	3/8	1.00 (25.4)	III	9.0 (0.35)	22.4 (0.88)	17.3 (0.68)	91.0 (3.58)	Green
TCTS2-1-1/2-IV-U	1	1/2	0.75 (19.1)	IV	9.0 (0.35)	22.4 (0.88)	18.5 (0.73)	11.0 (4.37)	Green
TCTS2-1/0-1/4-I-U	1/0	1/4	0.63 (15.9)	I	9.9 (0.39)	22.4 (0.88)	19.1 (0.75)	82.0 (3.23)	Pink
TCTS2-1/0-1/4-II-U	1/0	1/4	0.75 (19.1)	II	9.9 (0.39)	22.4 (0.88)	19.1 (0.75)	85.5 (3.37)	Pink

Copper Compression Lugs with Standard Barrel - Two Holes (with inspection window)

Description	Conductor AWG/MCM	Dimensions mm (In)							Color Code
		E (Stud Hole)	Stud Hole Spacing	Type	A (Barrel ID)	B (Barrel Length)	D (Palm Width)	J (Total Length)	
TCTS2-1/0-5/16-VI-U	1/0	5/16	0.87 (22.2)	VI	9.9 (0.39)	22.4 (0.88)	19.1 (0.75)	88.5 (3.48)	Pink
TCTS2-1/0-3/8-III-U	1/0	3/8	1.00 (25.4)	III	9.9 (0.39)	22.4 (0.88)	19.1 (0.75)	91.5 (3.6)	Pink
TCTS2-1/0-1/2-IV-U	1/0	1/2	0.75 (19.1)	IV	9.9 (0.39)	22.4 (0.88)	19.1 (0.75)	110.5 (4.35)	Pink
TCTS2-2/0-1/4-I-U	2/0	1/4	0.63 (15.9)	I	11.3 (0.45)	23.9 (0.94)	20.8 (0.82)	85.0 (3.35)	Black
TCTS2-2/0-1/4-II-U	2/0	1/4	0.75 (19.1)	II	11.3 (0.45)	23.9 (0.94)	20.8 (0.82)	88.0 (3.46)	Black
TCTS2-2/0-5/16-VI-U	2/0	5/16	0.87 (22.2)	VI	11.3 (0.45)	23.9 (0.94)	15.7 (0.62)	91.0 (3.58)	Black
TCTS2-2/0-3/8-III-U	2/0	3/8	1.00 (25.4)	III	11.3 (0.45)	23.9 (0.94)	20.8 (0.82)	94.0 (3.7)	Black
TCTS2-2/0-1/2-IV-U	2/0	1/2	1.75 (44.5)	IV	11.3 (0.45)	23.9 (0.94)	20.8 (0.82)	113.2 (4.46)	Black
TCTS2-3/0-1/4-II-U	3/0	1/4	0.75 (19.1)	II	12.4 (0.49)	25.4 (1.00)	23.1 (0.91)	91.2 (3.59)	Orange
TCTS2-3/0-5/16-III-U	3/0	5/16	1.00 (25.4)	III	12.4 (0.49)	25.4 (1.00)	23.1 (0.91)	97.5 (3.84)	Orange
TCTS2-3/0-3/8-III-U	3/0	3/8	1.00 (25.4)	III	12.4 (0.49)	25.4 (1.00)	23.1 (0.91)	97.5 (3.84)	Orange
TCTS2-3/0-1/2-IV-U	3/0	1/2	1.75 (44.5)	IV	12.4 (0.49)	25.4 (1.00)	23.1 (0.91)	116.7 (4.59)	Orange
TCTS2-4/0-1/4-II-U	4/0	1/4	0.75 (19.1)	II	14.2 (0.56)	22.4 (0.88)	25.4 (1.00)	89.0 (3.5)	Purple
TCTS2-4/0-1/4-III-U	4/0	1/4	1.00 (25.4)	III	14.2 (0.56)	22.4 (0.88)	25.4 (1.00)	95.5 (3.76)	Purple
TCTS2-4/0-3/8-III-U	4/0	3/8	1.00 (25.4)	III	14.2 (0.56)	22.4 (0.88)	25.4 (1.00)	95.5 (3.76)	Purple
TCTS2-4/0-1/2-IV-U	4/0	1/2	1.75 (44.5)	IV	14.2 (0.56)	22.4 (0.88)	25.4 (1.00)	115.0 (4.53)	Purple
TCTS2-250-3/8-III-U	250	3/8	1.00 (25.4)	III	15.1 (0.59)	26.9 (1.06)	27.7 (1.09)	102.0 (4.02)	Yellow
TCTS2-250-1/2-IV-U	250	1/2	1.75 (44.5)	IV	15.1 (0.59)	26.9 (1.06)	27.7 (1.09)	121.0 (4.76)	Yellow
TCTS2-300-3/8-III-U	300	3/8	1.00 (25.4)	III	16.5 (0.65)	26.2 (1.03)	30.5 (1.20)	102.0 (4.02)	White
TCTS2-300-1/2-IV-U	300	1/2	1.75 (44.5)	IV	16.5 (0.65)	26.2 (1.03)	30.5 (1.20)	121.0 (4.76)	White
TCTS2-350-1/4-II-U	350	1/4	0.75 (19.1)	II	17.8 (0.7)	26.9 (1.06)	32.8 (1.29)	95.0 (3.74)	Red
TCTS2-350-3/8-III-U	350	3/8	1.00 (25.4)	III	17.8 (0.7)	26.9 (1.06)	32.8 (1.29)	102.0 (4.02)	Red
TCTS2-350-1/2-VII-U	350	1/2	1.25 (31.8)	VII	17.8 (0.7)	32.8 (1.29)	32.8 (1.29)	115.0 (4.53)	Red
TCTS2-350-1/2-IV-U	350	1/2	1.75 (44.5)	IV	17.8 (0.7)	32.8 (1.29)	32.8 (1.29)	128.0 (5.04)	Red
TCTS2-400-3/8-III-U	400	3/8	1.00 (25.4)	III	19.3 (0.76)	30.2 (1.19)	35.1 (1.38)	108.0 (4.25)	Blue
TCTS2-400-1/2-IV-U	400	1/2	1.75 (44.5)	IV	19.3 (0.76)	30.2 (1.19)	35.6 (1.40)	128.0 (5.04)	Blue
TCTS2-500-1/4-II-U	500	1/4	0.75 (19.1)	II	21.1 (0.83)	32.3 (1.27)	39.1 (1.54)	102.0 (4.02)	Brown
TCTS2-500-3/8-III-U	500	3/8	1.00 (25.4)	III	21.1 (0.83)	32.3 (1.27)	39.1 (1.54)	110.0 (4.33)	Brown
TCTS2-500-1/2-IV-U	500	1/2	1.75 (44.5)	IV	21.1 (0.83)	32.3 (1.27)	39.1 (1.54)	129.0 (5.08)	Brown
TCTS2-600-3/8-III-U	600	3/8	1.00 (25.4)	III	23.4 (0.92)	35.1 (1.38)	43.4 (1.71)	117.0 (4.61)	Green
TCTS2-600-1/2-IV-U	600	1/2	1.75 (44.5)	IV	23.4 (0.92)	35.1 (1.38)	43.4 (1.71)	135.0 (5.31)	Green
TCTS2-750-3/8-III-U	750	3/8	1.00 (25.4)	III	26.2 (1.03)	36.1 (1.42)	48.0 (1.89)	118.0 (4.65)	Black
TCTS2-750-1/2-IV-U	750	1/2	1.75 (44.5)	IV	26.2 (1.03)	36.1 (1.42)	48.0 (1.89)	137.0 (5.39)	Black
TCTS2-1000-1/2-VII-U	1000	1/2	1.25 (31.8)	VII	29.7 (1.17)	41.9 (1.65)	55.6 (2.19)	133.0 (5.24)	White
TCTS2-1000-1/2-IV-U	1000	1/2	1.75 (44.5)	IV	29.7 (1.17)	41.9 (1.65)	55.6 (2.19)	147.0 (5.79)	White



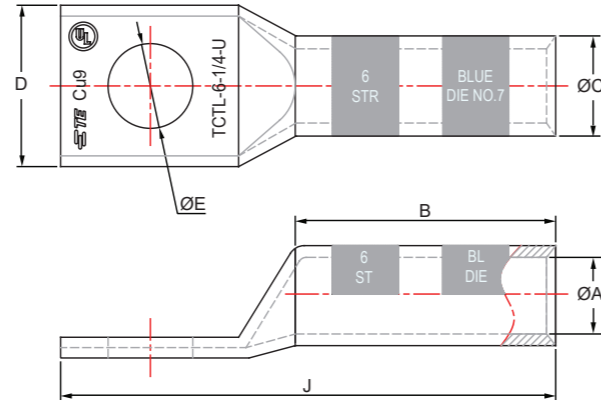
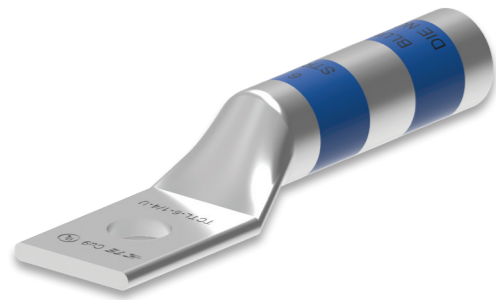

Copper Compression Lugs with Long Barrel - One Hole

Description	Conductor AWG/MCM	Dimensions mm (In)					Color Code
		E (Stud Hole)	A (Barrel ID)	B (Barrel Length)	D (Palm Width)	J (Total Length)	
TCTL-8-10-U	8	# 10	4.4 (0.20)	20.6 (0.81)	9.7 (0.38)	42.9 (1.69)	Red
TCTL-8-1/4-U	8	1/4	4.4 (0.20)	20.6 (0.81)	10.4 (0.41)	42.9 (1.69)	Red
TCTL-6-10-U	6	#10	5.0 (0.20)	28.4 (1.12)	10.4 (0.41)	48.3 (1.90)	Red
TCTL-6-1/4-U	6	1/4	5.0 (0.20)	28.4 (1.12)	10.4 (0.41)	48.3 (1.90)	Red
TCTL-6-1/2-U	6	1/2	5.0 (0.20)	28.4 (1.12)	21.1 (0.83)	67.1 (2.64)	Red
TCTL-4-10-U	4	# 10	6.3 (0.20)	28.4 (1.12)	12.4 (0.49)	48.3 (1.90)	Blue
TCTL-4-1/4-U	4	1/4	6.3 (0.20)	28.4 (1.12)	12.7 (0.50)	48.5 (1.91)	Blue
TCTL-4-3/8-U	4	3/8	6.3 (0.20)	28.4 (1.12)	14.7 (0.58)	57.2 (2.25)	Blue
TCTL-4-1/2-U	4	1/2	6.3 (0.20)	28.4 (1.12)	21.1 (0.83)	68.3 (2.69)	Blue
TCTL-2-10-U	2	# 10	7.8 (0.30)	31.8 (1.25)	15.5 (0.61)	56.0 (2.20)	Blue
TCTL-2-5/16-U	2	5/16	7.8 (0.30)	31.8 (1.25)	15.5 (0.61)	58.2 (2.29)	Blue
TCTL-2-1/2-U	2	1/2	7.8 (0.30)	31.8 (1.25)	21.1 (0.83)	73.2 (2.88)	Blue
TCTL-1-10-U	1	# 10	9.0 (0.40)	35.1 (1.38)	17.3 (0.68)	78.7 (3.10)	Gray
TCTL-1-5/16-U	1	5/16	9.0 (0.40)	35.1 (1.38)	17.3 (0.68)	78.7 (3.10)	Gray
TCTL-1-1/2-U	1	1/2	9.0 (0.40)	35.1 (1.38)	21.1 (0.83)	77.7 (3.06)	Gray
TCTL-1/0-10-U	1/0	# 10	9.9 (0.40)	35.1 (1.38)	19.1 (0.75)	78.7 (3.10)	Gray
TCTL-1/0-5/16-U	1/0	5/16	9.9 (0.40)	35.1 (1.38)	19.1 (0.75)	78.7 (3.10)	Brown
TCTL-1/0-3/8-U	1/0	3/8	9.9 (0.40)	35.1 (1.38)	19.1 (0.75)	78.7 (3.10)	Brown
TCTL-1/0-1/2-U	1/0	1/2	9.9 (0.40)	35.1 (1.38)	19.1 (0.75)	77.5 (3.05)	Brown
TCTL-2/0-3/8-U	2/0	3/8	11.3 (0.40)	38.1 (1.50)	20.8 (0.82)	81.3 (3.20)	Brown
TCTL-2/0-1/2-U	2/0	1/2	11.3 (0.40)	38.1 (1.50)	20.8 (0.82)	81.5 (3.21)	Brown
TCTL-3/0-3/8-U	3/0	3/8	12.4 (0.50)	38.1 (1.50)	23.1 (0.91)	77.7 (3.06)	Brown
TCTL-3/0-1/2-U	3/0	1/2	12.4 (0.50)	38.1 (1.50)	23.1 (0.91)	77.7 (3.06)	Brown
TCTL-4/0-3/8-U	4/0	3/8	14.2 (0.60)	41.1 (1.62)	25.4 (1.00)	75.7 (2.98)	Green
TCTL-4/0-1/2-U	4/0	1/2	14.2 (0.60)	41.1 (1.62)	25.4 (1.00)	82.0 (3.23)	Green
TCTL-250-1/2-U	250	1/2	15.1 (0.60)	41.1 (1.62)	27.7 (1.09)	82.8 (3.26)	Green

Copper Compression Lugs with Long Barrel - One Hole

Description	Conductor AWG/MCM	Dimensions mm (In)					Color Code
		E (Stud Hole)	A (Barrel ID)	B (Barrel Length)	D (Palm Width)	J (Total Length)	
TCTL-300-5/16-U	300	5/16	16.5 (0.60)	50.8 (2.00)	30.5 (1.20)	93.7 (3.69)	Green
TCTL-300-3/8-U	300	3/8	16.5 (0.60)	50.8 (2.00)	30.5 (1.20)	93.7 (3.69)	Green
TCTL-300-1/2-U	300	1/2	16.5 (0.60)	50.8 (2.00)	30.5 (1.20)	93.7 (3.69)	Pink
TCTL-350-3/8-U	350	3/8	17.8 (0.70)	50.8 (2.00)	32.8 (1.29)	94.7 (3.73)	Pink
TCTL-350-1/2-U	350	1/2	17.8 (0.70)	50.8 (2.00)	32.8 (1.29)	94.7 (3.73)	Pink
TCTL-400-3/8-U	400	3/8	19.3 (0.80)	53.8 (2.12)	35.1 (1.38)	104.1 (4.10)	Pink
TCTL-400-1/2-U	400	1/2	19.3 (0.80)	53.8 (2.12)	35.1 (1.38)	104.1 (4.10)	Pink
TCTL-400-5/8-U	400	5/8	19.3 (0.80)	53.8 (2.12)	35.1 (1.38)	104.1 (4.10)	Black
TCTL-500-1/2-U	500	1/2	21.1 (0.80)	57.2 (2.25)	39.1 (1.54)	111.8 (4.40)	Black
TCTL-500-5/8-U	500	5/8	21.1 (0.80)	57.2 (2.25)	39.1 (1.54)	111.8 (4.40)	Black
TCTL-600-1/2-U	600	1/2	23.4 (0.90)	68.3 (2.69)	43.4 (1.71)	122.7 (4.83)	Black
TCTL-600-5/8-U	600	5/8	23.4 (0.90)	68.3 (2.69)	43.4 (1.71)	121.9 (4.80)	Black
TCTL-750-1/2-U	750	1/2	26.2 (1.00)	73.2 (2.88)	48.0 (1.89)	129.8 (5.11)	Orange
TCTL-750-5/8-U	750	5/8	26.2 (1.00)	73.2 (2.88)	48.0 (1.89)	129.5 (5.10)	Orange
TCTL-1000-1/2-U	1000	1/2	29.7 (1.20)	76.2 (3.00)	55.6 (2.19)	137.2 (5.40)	Orange
TCTL-1000-5/8-U	1000	5/8	29.7 (1.20)	76.2 (3.00)	55.6 (2.19)	137.2 (5.40)	Orange



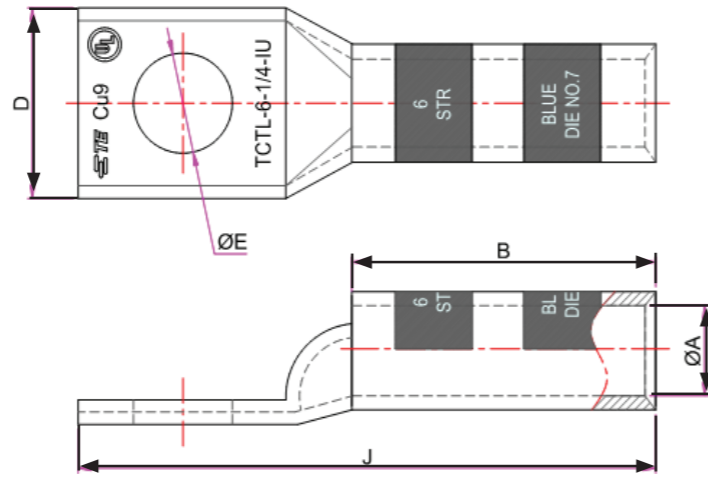
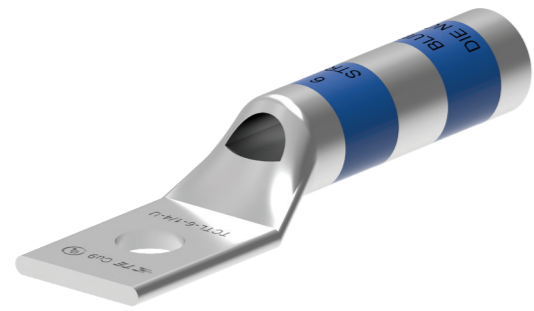

Copper Compression Lugs with Long Barrel - One Hole (with inspection window)

Description	Conductor AWG/MCM	Dimensions mm (In)					Color Code
		E (Stud Hole)	A (Barrel ID)	B (Barrel Length)	D (Palm Width)	J (Total Length)	
TCTL-8-10-IU	8	# 10	4.4 (0.20)	20.6 (0.81)	9.7 (0.38)	42.9 (1.69)	Red
TCTL-8-1/4-IU	8	1/4	4.4 (0.20)	20.6 (0.81)	10.4 (0.41)	42.9 (1.69)	Red
TCTL-6-10-IU	6	#10	5.0 (0.20)	28.4 (1.12)	10.4 (0.41)	48.3 (1.90)	Red
TCTL-6-1/4-IU	6	1/4	5.0 (0.20)	28.4 (1.12)	10.4 (0.41)	48.3 (1.90)	Red
TCTL-6-1/2-IU	6	1/2	5.0 (0.20)	28.4 (1.12)	21.1 (0.83)	67.1 (2.64)	Red
TCTL-4-10-IU	4	# 10	6.3 (0.20)	28.4 (1.12)	12.4 (0.49)	48.3 (1.90)	Blue
TCTL-4-1/4-IU	4	1/4	6.3 (0.20)	28.4 (1.12)	12.7 (0.50)	48.5 (1.91)	Blue
TCTL-4-3/8-IU	4	3/8	6.3 (0.20)	28.4 (1.12)	14.7 (0.58)	57.2 (2.25)	Blue
TCTL-4-1/2-IU	4	1/2	6.3 (0.20)	28.4 (1.12)	21.1 (0.83)	68.3 (2.69)	Blue
TCTL-2-10-IU	2	# 10	7.8 (0.30)	31.8 (1.25)	15.5 (0.61)	56.0 (2.20)	Blue
TCTL-2-5/16-IU	2	5/16	7.8 (0.30)	31.8 (1.25)	15.5 (0.61)	58.2 (2.29)	Blue
TCTL-2-1/2-IU	2	1/2	7.8 (0.30)	31.8 (1.25)	21.1 (0.83)	73.2 (2.88)	Blue
TCTL-1-10-IU	1	# 10	9.0 (0.40)	35.1 (1.38)	17.3 (0.68)	78.7 (3.10)	Gray
TCTL-1-5/16-IU	1	5/16	9.0 (0.40)	35.1 (1.38)	17.3 (0.68)	78.7 (3.10)	Gray
TCTL-1-1/2-IU	1	1/2	9.0 (0.40)	35.1 (1.38)	21.1 (0.83)	77.7 (3.06)	Gray
TCTL-1/0-10-IU	1/0	# 10	9.9 (0.40)	35.1 (1.38)	19.1 (0.75)	78.7 (3.10)	Gray
TCTL-1/0-5/16-IU	1/0	5/16	9.9 (0.40)	35.1 (1.38)	19.1 (0.75)	78.7 (3.10)	Brown
TCTL-1/0-3/8-IU	1/0	3/8	9.9 (0.40)	35.1 (1.38)	19.1 (0.75)	78.7 (3.10)	Brown
TCTL-1/0-1/2-IU	1/0	1/2	9.9 (0.40)	35.1 (1.38)	19.1 (0.75)	77.5 (3.05)	Brown
TCTL-2/0-3/8-IU	2/0	3/8	11.3 (0.40)	38.1 (1.50)	20.8 (0.82)	81.3 (3.20)	Brown
TCTL-2/0-1/2-IU	2/0	1/2	11.3 (0.40)	38.1 (1.50)	20.8 (0.82)	81.5 (3.21)	Brown
TCTL-3/0-3/8-IU	3/0	3/8	12.4 (0.50)	38.1 (1.50)	23.1 (0.91)	77.7 (3.06)	Brown
TCTL-3/0-1/2-IU	3/0	1/2	12.4 (0.50)	38.1 (1.50)	23.1 (0.91)	77.7 (3.06)	Brown
TCTL-4/0-3/8-IU	4/0	3/8	14.2 (0.60)	41.1 (1.62)	25.4 (1.00)	75.7 (2.98)	Green
TCTL-4/0-1/2-IU	4/0	1/2	14.2 (0.60)	41.1 (1.62)	25.4 (1.00)	82.0 (3.23)	Green
TCTL-250-1/2-IU	250	1/2	15.1 (0.60)	41.1 (1.62)	27.7 (1.09)	82.8 (3.26)	Green

Copper Compression Lugs with Long Barrel - One Hole (with inspection window)

Description	Conductor AWG/MCM	Dimensions mm (In)					Color Code
		E (Stud Hole)	A (Barrel ID)	B (Barrel Length)	D (Palm Width)	J (Total Length)	
TCTL-300-5/16-IU	300	5/16	16.5 (0.60)	50.8 (2.00)	30.5 (1.20)	93.7 (3.69)	Green
TCTL-300-3/8-IU	300	3/8	16.5 (0.60)	50.8 (2.00)	30.5 (1.20)	93.7 (3.69)	Green
TCTL-300-1/2-IU	300	1/2	16.5 (0.60)	50.8 (2.00)	30.5 (1.20)	93.7 (3.69)	Pink
TCTL-350-3/8-IU	350	3/8	17.8 (0.70)	50.8 (2.00)	32.8 (1.29)	94.7 (3.73)	Pink
TCTL-350-1/2-IU	350	1/2	17.8 (0.70)	50.8 (2.00)	32.8 (1.29)	94.7 (3.73)	Pink
TCTL-400-3/8-IU	400	3/8	19.3 (0.80)	53.8 (2.12)	35.1 (1.38)	104.1 (4.10)	Pink
TCTL-400-1/2-IU	400	1/2	19.3 (0.80)	53.8 (2.12)	35.1 (1.38)	104.1 (4.10)	Pink
TCTL-400-5/8-IU	400	5/8	19.3 (0.80)	53.8 (2.12)	35.1 (1.38)	104.1 (4.10)	Black
TCTL-500-1/2-IU	500	1/2	21.1 (0.80)	57.2 (2.25)	39.1 (1.54)	111.8 (4.40)	Black
TCTL-500-5/8-IU	500	5/8	21.1 (0.80)	57.2 (2.25)	39.1 (1.54)	111.8 (4.40)	Black
TCTL-600-1/2-IU	600	1/2	23.4 (0.90)	68.3 (2.69)	43.4 (1.71)	122.7 (4.83)	Black
TCTL-600-5/8-IU	600	5/8	23.4 (0.90)	68.3 (2.69)	43.4 (1.71)	121.9 (4.80)	Black
TCTL-750-1/2-IU	750	1/2	26.2 (1.00)	73.2 (2.88)	48.0 (1.89)	129.8 (5.11)	Orange
TCTL-750-5/8-IU	750	5/8	26.2 (1.00)	73.2 (2.88)	48.0 (1.89)	129.5 (5.10)	Orange
TCTL-1000-1/2-IU	1000	1/2	29.7 (1.20)	76.2 (3.00)	55.6 (2.19)	137.2 (5.40)	Orange
TCTL-1000-5/8-IU	1000	5/8	29.7 (1.20)	76.2 (3.00)	55.6 (2.19)	137.2 (5.40)	Orange





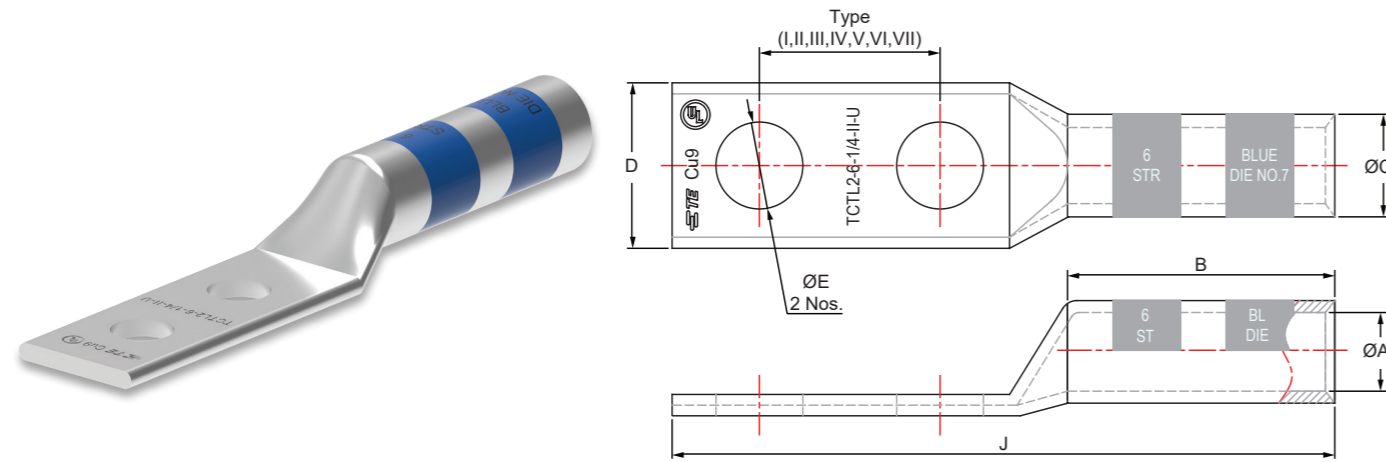

Copper Compression Lugs with Long Barrel - Two Holes

Description	Conductor AWG/MCM	Dimensions mm (In)							Color Code
		E (Stud Hole)	Stud Hole Spacing	Type	A (Barrel ID)	B (Barrel Length)	D (Palm Width)	J (Total Length)	
TCTL2-8-1/4-I-U	8	1/4	0.63 (15.9)	I	4.4 (0.17)	20.6 (0.81)	10.7 (0.42)	59.2 (2.33)	Red
TCTL2-8-1/4-II-U	8	1/4	0.75 (19.1)	II	4.4 (0.14)	20.6 (0.81)	10.7 (0.42)	62.2 (2.45)	Red
TCTL2-6-1/4-I-U	6	1/4	0.63 (15.9)	I	5.0 (0.20)	28.4 (1.12)	10.7 (0.42)	67.3 (2.65)	Blue
TCTL2-6-1/4-III-U	6	1/4	1.00 (25.4)	III	5.0 (0.20)	28.4 (1.12)	10.7 (0.42)	77.0 (3.03)	Blue
TCTL2-6-1/2-IV-U	6	1/2	1.75 (44.5)	IV	5.0 (0.20)	28.4 (1.12)	20.6 (0.81)	118.8 (4.40)	Blue
TCTL2-6-3/8-III-U	6	3/8	1.00 (25.4)	III	5.0 (0.20)	28.4 (1.12)	14.5 (0.57)	81.8 (3.22)	Blue
TCTL2-6-3/8-II-U	6	3/8	0.75 (19.1)	II	5.0 (0.20)	28.4 (1.12)	14.5 (0.57)	75.4 (2.97)	Blue
TCTL2-4-1/4-I-U	4	1/4	0.63 (15.9)	I	6.3 (0.25)	28.4 (1.12)	12.7 (0.50)	68.6 (2.70)	Gray
TCTL2-4-1/4-II-U	4	1/4	0.75 (19.1)	II	6.3 (0.25)	28.4 (1.12)	12.7 (0.50)	71.9 (2.83)	Gray
TCTL2-4-3/8-III-U	4	3/8	1.00 (25.4)	III	6.3 (0.25)	28.4 (1.12)	14.2 (0.56)	82.8 (3.26)	Gray
TCTL2-4-1/2-IV-U	4	1/2	1.75 (44.5)	IV	6.3 (0.25)	28.4 (1.12)	20.6 (0.81)	113.0 (4.45)	Gray
TCTL2-2-1/4-I-U	2	1/4	0.63 (15.9)	I	7.8 (0.31)	31.8 (1.25)	15.5 (0.61)	77.5 (3.05)	Brown
TCTL2-2-1/4-II-U	2	1/4	0.75 (19.1)	II	7.8 (0.31)	31.8 (1.25)	15.5 (0.61)	80.5 (3.17)	Brown
TCTL2-2-5/16-II-U	2	5/16	0.75 (19.1)	II	7.8 (0.31)	31.8 (1.25)	15.5 (0.61)	80.5 (3.17)	Brown
TCTL2-2-3/8-IV-U	2	3/8	1.75 (44.5)	IV	7.8 (0.31)	31.8 (1.25)	15.5 (0.61)	105.9 (4.17)	Brown
TCTL2-2-3/8-III-U	2	3/8	1.00 (25.4)	III	7.8 (0.31)	31.8 (1.25)	15.5 (0.61)	86.9 (3.42)	Brown
TCTL2-2-1/2-IV-U	2	1/2	1.75 (44.5)	IV	7.8 (0.31)	31.8 (1.25)	15.5 (0.61)	105.9 (4.17)	Brown
TCTL2-1-1/4-I-U	1	1/4	0.63 (15.9)	I	9.0 (0.35)	35.1 (1.38)	17.3 (0.68)	93.5 (3.68)	Green
TCTL2-1-1/4-II-U	1	1/4	0.75 (19.1)	II	9.0 (0.35)	35.1 (1.38)	17.3 (0.68)	96.5 (3.80)	Green
TCTL2-1-5/16-II-U	1	5/16	0.75 (19.1)	II	9.0 (0.35)	35.1 (1.38)	17.3 (0.68)	96.5 (3.80)	Green
TCTL2-1-3/8-III-U	1	3/8	1.00 (25.4)	III	9.0 (0.35)	35.1 (1.38)	17.3 (0.68)	102.9 (4.05)	Green
TCTL2-1-1/2-IV-U	1	1/2	1.75 (44.5)	IV	9.0 (0.35)	35.1 (1.38)	19.1 (0.75)	122.4 (4.82)	Green
TCTL2-1/0-1/4-I-U	1/0	1/4	0.63 (15.9)	I	9.9 (0.39)	35.1 (1.38)	19.1 (0.75)	91.9 (3.62)	Pink
TCTL2-1/0-1/4-II-U	1/0	1/4	0.75 (19.1)	II	9.9 (0.39)	35.1 (1.38)	19.1 (0.75)	95.3 (3.75)	Pink
TCTL2-1/0-5/16-III-U	1/0	5/16	1.00 (25.4)	III	9.9 (0.39)	35.1 (1.38)	19.1 (0.75)	102.0 (4.02)	Pink
TCTL2-1/0-3/8-III-U	1/0	3/8	1.00 (25.4)	III	9.9 (0.39)	35.1 (1.38)	19.1 (0.75)	102.0 (4.02)	Pink
TCTL2-1/0-3/8-IV-U	1/0	3/8	1.75 (44.5)	IV	9.9 (0.39)	35.1 (1.38)	19.1 (0.75)	121.9 (4.80)	Pink
TCTL2-1/0-1/2-IV-U	1/0	1/2	1.75 (44.5)	IV	9.9 (0.39)	35.1 (1.38)	20.6 (0.81)	122.2 (4.81)	Pink
TCTL2-2/0-1/4-I-U	2/0	1/4	0.63 (15.9)	I	11.3 (0.45)	38.1 (1.50)	20.8 (0.82)	95.3 (3.75)	Black
TCTL2-2/0-1/4-II-U	2/0	1/4	0.75 (19.1)	II	11.3 (0.45)	38.1 (1.50)	20.8 (0.82)	99.1 (3.90)	Black

Copper Compression Lugs with Long Barrel - Two Holes

TE Product Code	Conductor AWG/MCM	Dimensions mm (In)							Color Code
		E (Stud Hole)	Stud Hole Spacing	Type	A (Barrel ID)	B (Barrel Length)	D (Palm Width)	J (Total Length)	
TCTL2-2/0-3/8-III-U	2/0	3/8	1.00 (25.4)	III	11.3 (0.45)	38.1 (1.50)	20.8 (0.82)	105.4 (4.15)	Black
TCTL2-2/0-1/2-IV-U	2/0	1/2	1.75 (44.5)	IV	11.3 (0.45)	38.1 (1.50)	20.8 (0.82)	126.2 (4.97)	Black
TCTL2-3/0-1/4-II-U	3/0	1/4	0.75 (19.1)	II	12.4 (0.49)	38.1 (1.50)	23.1 (0.91)	101.6 (4.00)	Orange
TCTL2-3/0-3/8-III-U	3/0	3/8	1.00 (25.4)	III	12.4 (0.49)	38.1 (1.50)	23.1 (0.91)	108.0 (4.25)	Orange
TCTL2-4/0-1/4-II-U	4/0	1/4	0.75 (19.1)	II	14.2 (0.56)	41.1 (1.62)	25.4 (1.00)	105.4 (4.15)	Purple
TCTL2-4/0-3/8-IV-U	4/0	3/8	1.75 (44.5)	IV	14.2 (0.56)	41.1 (1.62)	25.4 (1.00)	130.8 (5.15)	Purple
TCTL2-4/0-3/8-III-U	4/0	3/8	1.00 (25.4)	III	14.2 (0.56)	41.1 (1.62)	25.4 (1.00)	111.8 (4.40)	Purple
TCTL2-4/0-1/2-IV-U	4/0	1/2	1.75 (44.5)	IV	14.2 (0.56)	41.1 (1.62)	25.4 (1.00)	131.3 (5.17)	Purple
TCTL2-250-3/8-III-U	250	3/8	1.00 (25.4)	III	15.1 (0.59)	41.1 (1.62)	27.7 (1.09)	113.3 (4.46)	Yellow
TCTL2-250-1/2-IV-U	250	1/2	1.75 (44.5)	IV	15.1 (0.59)	41.1 (1.62)	27.7 (1.09)	132.3 (5.21)	Yellow
TCTL2-300-3/8-III-U	300	3/8	1.00 (25.4)	III	16.5 (0.65)	50.8 (2.00)	30.5 (1.20)	124.2 (4.89)	White
TCTL2-300-1/2-IV-U	300	1/2	1.75 (44.5)	IV	16.5 (0.65)	50.8 (2.00)	30.5 (1.20)	143.3 (5.64)	White
TCTL2-350-1/4-II-U	350	1/4	0.75 (19.1)	II	17.8 (0.70)	50.8 (2.00)	32.8 (1.29)	115.6 (4.55)	Red
TCTL2-350-3/8-III-U	350	3/8	1.00 (25.4)	III	17.8 (0.70)	50.8 (2.00)	32.8 (1.29)	123.2 (4.85)	Red
TCTL2-350-1/2-IV-U	350	1/2	1.75 (44.5)	IV	17.8 (0.70)	50.8 (2.00)	32.8 (1.29)	144.3 (5.68)	Red
TCTL2-400-3/8-III-U	400	3/8	1.00 (25.4)	III	19.3 (0.76)	53.8 (2.12)	35.1 (1.38)	127.0 (5.00)	Blue
TCTL2-400-1/2-IV-U	400	1/2	1.75 (44.5)	IV	19.3 (0.76)	53.8 (2.12)	35.1 (1.38)	148.6 (5.85)	Blue
TCTL2-500-1/4-II-U	500	1/4	0.75 (19.1)	II	21.1 (0.83)	57.2 (2.25)	39.1 (1.54)	123.2 (4.85)	Brown
TCTL2-500-3/8-III-U	500	3/8	1.00 (25.4)	III	21.1 (0.83)	57.2 (2.25)	39.1 (1.54)	129.5 (5.10)	Brown
TCTL2-500-1/2-IV-U	500	1/2	1.75 (44.5)	IV	21.1 (0.83)	57.2 (2.25)	39.1 (1.54)	153.9 (6.06)	Brown
TCTL2-600-3/8-III-U	600	3/8	1.00 (25.4)	III	23.4 (0.92)	68.3 (2.69)	43.4 (1.71)	142.0 (5.59)	Green
TCTL2-600-1/2-IV-U	600	1/2	1.75 (44.5)	IV	23.4 (0.92)	68.3 (2.69)	43.4 (1.71)	167.4 (6.59)	Green
TCTL2-750-1/2-IV-U	750	1/2	1.75 (44.5)	IV	26.2 (1.03)	73.2 (2.88)	48.0 (1.89)	174.5 (6.87)	Black
TCTL2-750-3/8-III-U	750	3/8	1.00 (25.4)	III	26.2 (1.03)	73.2 (2.88)	48.0 (1.89)	149.1 (5.87)	Black
TCTL2-1000-1/2-IV-U	1000	1/2	1.75 (44.5)	IV	3.0 (1.17)	76.2 (3.00)	55.6 (2.19)	181.4 (7.14)	White
TCTL2-1000-3/8-III-U	1000	3/8	1.00 (25.4)	III	3.0 (1.17)	76.2 (3.00)	55.6 (2.19)	156.0 (6.14)	White



## Copper And Aluminum Compression Lugs

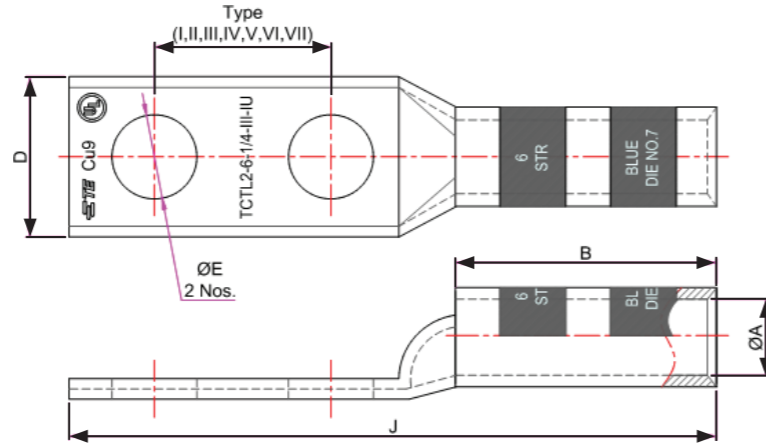

### Copper Compression Lugs with Long Barrel - Two Holes (with inspection window)

Description	Conductor AWG/MCM	Dimensions mm (In)							Color Code
		E (Stud Hole)	Stud Hole Spacing	Type	A (Barrel ID)	B (Barrel Length)	D (Palm Width)	J (Total Length)	
TCTL2-8-1/4-I-IU	8	1/4	0.63 (15.9)	I	4.4 (0.17)	20.6 (0.81)	10.7 (0.42)	59.2 (2.33)	Red
TCTL2-8-1/4-II-IU	8	1/4	0.75 (19.1)	II	4.4 (0.14)	20.6 (0.81)	10.7 (0.42)	62.2 (2.45)	Red
TCTL2-6-1/4-I-IU	6	1/4	0.63 (15.9)	I	5.0 (0.20)	28.4 (1.12)	10.7 (0.42)	67.3 (2.65)	Blue
TCTL2-6-1/4-III-IU	6	1/4	1.00 (25.4)	III	5.0 (0.20)	28.4 (1.12)	10.7 (0.42)	77.0 (3.03)	Blue
TCTL2-6-1/2-IV-IU	6	1/2	1.75 (44.5)	IV	5.0 (0.20)	28.4 (1.12)	20.6 (0.81)	118.8 (4.40)	Blue
TCTL2-6-3/8-III-IU	6	3/8	1.00 (25.4)	III	5.0 (0.20)	28.4 (1.12)	14.5 (0.57)	81.8 (3.22)	Blue
TCTL2-6-3/8-II-IU	6	3/8	0.75 (19.1)	II	5.0 (0.20)	28.4 (1.12)	14.5 (0.57)	75.4 (2.97)	Blue
TCTL2-4-1/4-I-IU	4	1/4	0.63 (15.9)	I	6.3 (0.25)	28.4 (1.12)	12.7 (0.50)	68.6 (2.70)	Gray
TCTL2-4-1/4-II-IU	4	1/4	0.75 (19.1)	II	6.3 (0.25)	28.4 (1.12)	12.7 (0.50)	71.9 (2.83)	Gray
TCTL2-4-3/8-III-IU	4	3/8	1.00 (25.4)	III	6.3 (0.25)	28.4 (1.12)	14.2 (0.56)	82.8 (3.26)	Gray
TCTL2-4-1/2-IV-IU	4	1/2	1.75 (44.5)	IV	6.3 (0.25)	28.4 (1.12)	20.6 (0.81)	113.0 (4.45)	Gray
TCTL2-2-1/4-I-IU	2	1/4	0.63 (15.9)	I	7.8 (0.31)	31.8 (1.25)	15.5 (0.61)	77.5 (3.05)	Brown
TCTL2-2-1/4-II-IU	2	1/4	0.75 (19.1)	II	7.8 (0.31)	31.8 (1.25)	15.5 (0.61)	80.5 (3.17)	Brown
TCTL2-2-5/16-II-IU	2	5/16	0.75 (19.1)	II	7.8 (0.31)	31.8 (1.25)	15.5 (0.61)	80.5 (3.17)	Brown
TCTL2-2-3/8-IV-IU	2	3/8	1.75 (44.5)	IV	7.8 (0.31)	31.8 (1.25)	15.5 (0.61)	105.9 (4.17)	Brown
TCTL2-2-3/8-III-IU	2	3/8	1.00 (25.4)	III	7.8 (0.31)	31.8 (1.25)	15.5 (0.61)	86.9 (3.42)	Brown
TCTL2-2-1/2-IV-IU	2	1/2	1.75 (44.5)	IV	7.8 (0.31)	31.8 (1.25)	15.5 (0.61)	105.9 (4.17)	Brown
TCTL2-1-1/4-I-IU	1	1/4	0.63 (15.9)	I	9.0 (0.35)	35.1 (1.38)	17.3 (0.68)	93.5 (3.68)	Green
TCTL2-1-1/4-II-IU	1	1/4	0.75 (19.1)	II	9.0 (0.35)	35.1 (1.38)	17.3 (0.68)	96.5 (3.80)	Green
TCTL2-1-5/16-II-IU	1	5/16	0.75 (19.1)	II	9.0 (0.35)	35.1 (1.38)	17.3 (0.68)	96.5 (3.80)	Green
TCTL2-1-3/8-III-IU	1	3/8	1.00 (25.4)	III	9.0 (0.35)	35.1 (1.38)	17.3 (0.68)	102.9 (4.05)	Green
TCTL2-1-1/2-IV-IU	1	1/2	1.75 (44.5)	IV	9.0 (0.35)	35.1 (1.38)	19.1 (0.75)	122.4 (4.82)	Green
TCTL2-1/0-1/4-I-IU	1/0	1/4	0.63 (15.9)	I	9.9 (0.39)	35.1 (1.38)	19.1 (0.75)	91.9 (3.62)	Pink
TCTL2-1/0-1/4-II-IU	1/0	1/4	0.75 (19.1)	II	9.9 (0.39)	35.1 (1.38)	19.1 (0.75)	95.3 (3.75)	Pink
TCTL2-1/0-5/16-III-IU	1/0	5/16	1.00 (25.4)	III	9.9 (0.39)	35.1 (1.38)	19.1 (0.75)	102.0 (4.02)	Pink
TCTL2-1/0-3/8-III-IU	1/0	3/8	1.00 (25.4)	III	9.9 (0.39)	35.1 (1.38)	19.1 (0.75)	102.0 (4.02)	Pink
TCTL2-1/0-3/8-IV-IU	1/0	3/8	1.75 (44.5)	IV	9.9 (0.39)	35.1 (1.38)	19.1 (0.75)	121.9 (4.80)	Pink
TCTL2-1/0-1/2-IV-IU	1/0	1/2	1.75 (44.5)	IV	9.9 (0.39)	35.1 (1.38)	20.6 (0.81)	122.2 (4.81)	Pink
TCTL2-2/0-1/4-I-IU	2/0	1/4	0.63 (15.9)	I	11.3 (0.45)	38.1 (1.50)	20.8 (0.82)	95.3 (3.75)	Black
TCTL2-2/0-1/4-II-IU	2/0	1/4	0.75 (19.1)	II	11.3 (0.45)	38.1 (1.50)	20.8 (0.82)	99.1 (3.90)	Black

## Copper And Aluminum Compression Lugs

### Copper Compression Lugs with Long Barrel - Two Holes (with inspection window)

Description	Conductor AWG/MCM	Dimensions mm (In)							Color Code
		E (Stud Hole)	Stud Hole Spacing	Type	A (Barrel ID)	B (Barrel Length)	D (Palm Width)	J (Total Length)	
TCTL2-2/0-3/8-III-IU	2/0	3/8	1.00 (25.4)	III	11.3 (0.45)	38.1 (1.50)	20.8 (0.82)	105.4 (4.15)	Black
TCTL2-2/0-1/2-IV-IU	2/0	1/2	1.75 (44.5)	IV	11.3 (0.45)	38.1 (1.50)	20.8 (0.82)	126.2 (4.97)	Black
TCTL2-3/0-1/4-II-IU	3/0	1/4	0.75 (19.1)	II	12.4 (0.49)	38.1 (1.50)	23.1 (0.91)	101.6 (4.00)	Orange
TCTL2-3/0-3/8-III-IU	3/0	3/8	1.00 (25.4)	III	12.4 (0.49)	38.1 (1.50)	23.1 (0.91)	108.0 (4.25)	Orange
TCTL2-4/0-1/4-II-IU	4/0	1/4	0.75 (19.1)	II	14.2 (0.56)	41.1 (1.62)	25.4 (1.00)	105.4 (4.15)	Purple
TCTL2-4/0-3/8-IV-IU	4/0	3/8	1.75 (44.5)	IV	14.2 (0.56)	41.1 (1.62)	25.4 (1.00)	130.8 (5.15)	Purple
TCTL2-4/0-3/8-III-IU	4/0	3/8	1.00 (25.4)	III	14.2 (0.56)	41.1 (1.62)	25.4 (1.00)	111.8 (4.40)	Purple
TCTL2-4/0-1/2-IV-IU	4/0	1/2	1.75 (44.5)	IV	14.2 (0.56)	41.1 (1.62)	25.4 (1.00)	131.3 (5.17)	Purple
TCTL2-250-3/8-III-IU	250	3/8	1.00 (25.4)	III	15.1 (0.59)	41.1 (1.62)	27.7 (1.09)	113.3 (4.46)	Yellow
TCTL2-250-1/2-IV-IU	250	1/2	1.75 (44.5)	IV	15.1 (0.59)	41.1 (1.62)	27.7 (1.09)	132.3 (5.21)	Yellow
TCTL2-300-3/8-III-IU	300	3/8	1.00 (25.4)	III	16.5 (0.65)	50.8 (2.00)	30.5 (1.20)	124.2 (4.89)	White
TCTL2-300-1/2-IV-IU	300	1/2	1.75 (44.5)	IV	16.5 (0.65)	50.8 (2.00)	30.5 (1.20)	143.3 (5.64)	White
TCTL2-350-1/4-II-IU	350	1/4	0.75 (19.1)	II	17.8 (0.70)	50.8 (2.00)	32.8 (1.29)	115.6 (4.55)	Red
TCTL2-350-3/8-III-IU	350	3/8	1.00 (25.4)	III	17.8 (0.70)	50.8 (2.00)	32.8 (1.29)	123.2 (4.85)	Red
TCTL2-350-1/2-IV-IU	350	1/2	1.75 (44.5)	IV	17.8 (0.70)	50.8 (2.00)	32.8 (1.29)	144.3 (5.68)	Red
TCTL2-400-3/8-III-IU	400	3/8	1.00 (25.4)	III	19.3 (0.76)	53.8 (2.12)	35.1 (1.38)	127.0 (5.00)	Blue
TCTL2-400-1/2-IV-IU	400	1/2	1.75 (44.5)	IV	19.3 (0.76)	53.8 (2.12)	35.1 (1.38)	148.6 (5.85)	Blue
TCTL2-500-1/4-II-IU	500	1/4	0.75 (19.1)	II	21.1 (0.83)	57.2 (2.25)	39.1 (1.54)	123.2 (4.85)	Brown
TCTL2-500-3/8-III-IU	500	3/8	1.00 (25.4)	III	21.1 (0.83)	57.2 (2.25)	39.1 (1.54)	129.5 (5.10)	Brown
TCTL2-500-1/2-IV-IU	500	1/2	1.75 (44.5)	IV	21.1 (0.83)	57.2 (2.25)	39.1 (1.54)	153.9 (6.06)	Brown
TCTL2-600-3/8-III-IU	600	3/8	1.00 (25.4)	III	23.4 (0.92)	68.3 (2.69)	43.4 (1.71)	142.0 (5.59)	Green
TCTL2-600-1/2-IV-IU	600	1/2	1.75 (44.5)	IV	23.4 (0.92)	68.3 (2.69)	43.4 (1.71)	167.4 (6.59)	Green
TCTL2-750-1/2-IV-IU	750	1/2	1.75 (44.5)	IV	26.2 (1.03)	73.2 (2.88)	48.0 (1.89)	174.5 (6.87)	Black
TCTL2-750-3/8-III-IU	750	3/8	1.00 (25.4)	III	26.2 (1.03)	73.2 (2.88)	48.0 (1.89)	149.1 (5.87)	Black
TCTL2-1000-1/2-IV-IU	1000	1/2	1.75 (44.5)	IV	3.0 (1.17)	76.2 (3.00)	55.6 (2.19)	181.4 (7.14)	White
TCTL2-1000-3/8-III-IU	1000	3/8	1.00 (25.4)	III	3.0 (1.17)	76.2 (3.00)	55.6 (2.19)	156.0 (6.14)	White



### Dual Rated Aluminum Crimp Lugs

#### 1-Hole, 2-Hole Lugs

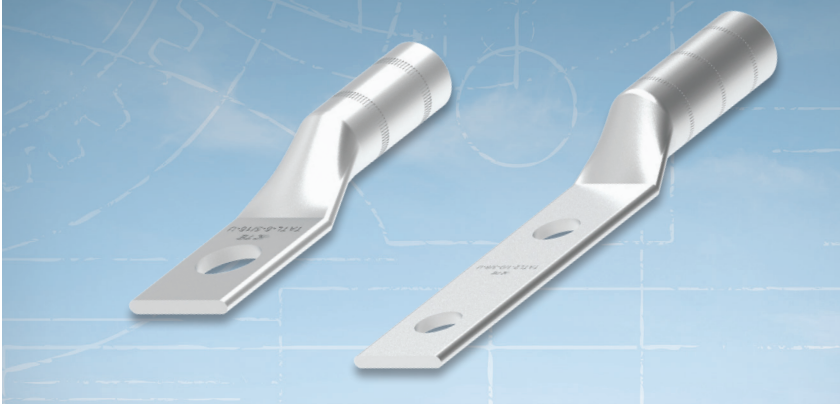

TE's crimp type compression lugs are made from high conductivity aluminum. They are electro-tin plated to resist electrolytic corrosion. They are suitable in applications from 600 V to 35 kV. Compression lugs are available to accommodate a broad range of cable sizes from #1/0 AWG to 750 kmcil in both copper and aluminum material, in one- or two-hole configurations.

The barrels are chamfered, or chamfered, for easy entry of the conductor. Also, they are pre-filled with oxide inhibitor compound to prevent contamination. The long barrel length provides extra contact with the conductor, post crimping. Every barrel cap is color-coded to the proper die for error-free die selection. It prevents the inhibitor from getting contaminated before installation.

#### Key Features

- Easy to install with industry standard tooling
- Electro tin-plated for electrolytic corrosion resistance and durability
- Industry standard, color coded barrel ends and caps simplify die selection and prevent contamination of Oxide-Inhibiting compound
- For 600 V to 35 kV applications
- Suitable with both aluminum and copper conductors

## Copper And Aluminum Compression Lugs

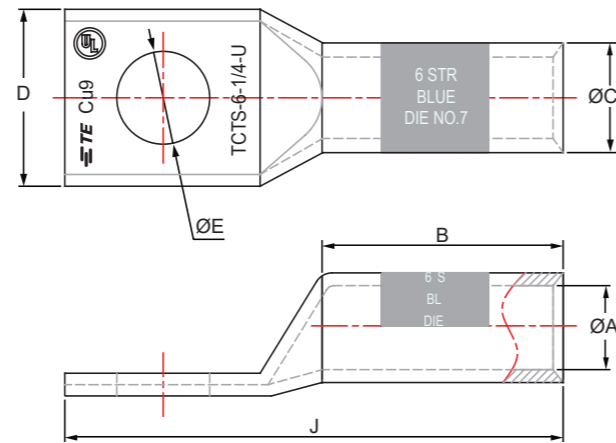

### Dual Rated Aluminum Crimp Lugs - One Hole

Description	Conductor AWG/MCM	Dimensions mm (inch)											
		E		A		C		B		D		J	
TATL-6-1/4-U	6 AWG	6.8	(1/4)	5.1	(0.20)	8.8	(0.35)	19.1	(0.75)	14.2	(0.56)	57.9	(2.28)
TATL-6-3/8-U	6 AWG	10.2	(3/8)	5.1	(0.20)	8.8	(0.35)	19.1	(0.75)	14.2	(0.56)	57.9	(2.28)
TATL-6-5/16-U	6 AWG	8.4	(5/16)	5.1	(0.20)	8.8	(0.35)	19.1	(0.75)	14.2	(0.56)	57.9	(2.28)
TATL-4-1/4-U	4 AWG	6.8	(1/4)	6.7	(0.26)	11.9	(0.47)	23.8	(0.94)	15.7	(0.62)	58.4	(2.3)
TATL-4-5/16-U	4 AWG	8.4	(5/16)	6.7	(0.26)	11.9	(0.47)	23.8	(0.94)	15.7	(0.62)	58.4	(2.3)
TATL-2-3/8-U	2 AWG	10.2	(3/8)	7.88	(0.31)	13.47	(0.53)	23.63	(0.93)	19.31	(0.76)	66.55	(2.62)
TATL-2-5/16-U	2 AWG	8.4	(5/16)	7.88	(0.31)	13.47	(0.53)	23.63	(0.93)	19.31	(0.76)	66.55	(2.62)
TATL-2-1/2-U	2 AWG	13.2	(1/2)	7.88	(0.31)	13.47	(0.53)	23.63	(0.93)	19.31	(0.76)	66.55	(2.62)
TATL-1-3/8-U	1 AWG	10.2	(3/8)	9.15	(0.36)	13.47	(0.53)	23.63	(0.93)	19.31	(0.76)	66.55	(2.62)
TATL-1-1/2-U	1 AWG	13.2	(1/2)	9.15	(0.36)	13.47	(0.53)	23.63	(0.93)	19.31	(0.76)	66.55	(2.62)
TATL-1/0-3/8-U	1/0 AWG	10.2	(3/8)	10.67	(0.42)	16.26	(0.64)	30.23	(1.19)	22.61	(0.89)	79.25	(3.12)
TATL-1/0-1/2-U	1/0 AWG	13.2	(1/2)	10.67	(0.42)	16.26	(0.64)	30.23	(1.19)	22.61	(0.89)	79.25	(3.12)
TATL-2/0-1/2-U	2/0 AWG	13.2	(1/2)	11.2	(0.44)	17.53	(0.69)	33.02	(1.3)	24.2	(0.95)	81.03	(3.19)
TATL-2/0-3/8-U	2/0 AWG	10.2	(3/8)	11.2	(0.44)	17.53	(0.69)	33.02	(1.3)	24.2	(0.95)	81.03	(3.19)
TATL-3/0-1/2-U	3/0 AWG	13.2	(1/2)	12.45	(0.49)	19.31	(0.76)	38.1	(1.5)	26.93	(1.06)	87.63	(3.45)
TATL-3/0-3/8-U	3/0 AWG	10.2	(3/8)	12.45	(0.49)	19.31	(0.76)	38.1	(1.5)	26.93	(1.06)	87.63	(3.45)
TATL-4/0-1/2-U	4/0 AWG	13.2	(1/2)	13.72	(0.54)	22.1	(0.87)	36.83	(1.45)	30.23	(1.19)	90.43	(3.56)
TATL-4/0-5/8-U	4/0 AWG	16.8	(5/8)	13.72	(0.54)	23.12	(0.91)	36.83	(1.45)	30.23	(1.19)	90.43	(3.56)
TATL-250-1/2-U	250 MCM	13.2	(1/2)	15.24	(0.6)	23.12	(0.91)	39.63	(1.56)	31.5	(1.24)	91.95	(3.62)
TATL-250-5/8-U	250 MCM	16.8	(5/8)	15.24	(0.6)	23.12	(0.91)	40.64	(1.6)	31.5	(1.24)	91.95	(3.62)
TATL-300-1/2-U	300 MCM	13.2	(1/2)	16.51	(0.65)	25.66	(1.01)	55.63	(2.19)	34.55	(1.36)	101.6	(4.0)
TATL-300-5/8-U	300 MCM	13.2	(1/2)	16.51	(0.65)	25.66	(1.01)	55.63	(2.19)	34.55	(1.36)	101.6	(4.0)
TATL-350-1/2-U	350 MCM	13.2	(1/2)	18.55	(0.73)	28.2	(1.11)	55.63	(2.19)	37.85	(1.49)	108.21	(4.26)
TATL-350-5/8-U	350 MCM	16.8	(5/8)	18.55	(0.73)	28.2	(1.11)	55.63	(2.19)	37.85	(1.49)	109.73	(4.32)
TATL-500-1/2-U	500 MCM	13.2	(1/2)	21.59	(0.85)	33.53	(1.32)	74.68	(2.94)	43.95	(1.73)	138.43	(5.45)
TATL-500-5/8-U	500 MCM	16.8	(5/8)	21.59	(0.85)	33.53	(1.32)	74.68	(2.94)	43.95	(1.73)	138.43	(5.45)
TATL-600-1/2-U	600 MCM	13.2	(1/2)	23.63	(0.93)	36.58	(1.44)	76.2	(3.0)	44.45	(1.75)	141.23	(5.56)
TATL-750-1/2-U	750 MCM	13.2	(1/2)	26.42	(1.04)	38.1	(1.5)	84.33	(3.32)	43.69	(1.72)	162.31	(6.39)

## Copper And Aluminum Compression Lugs

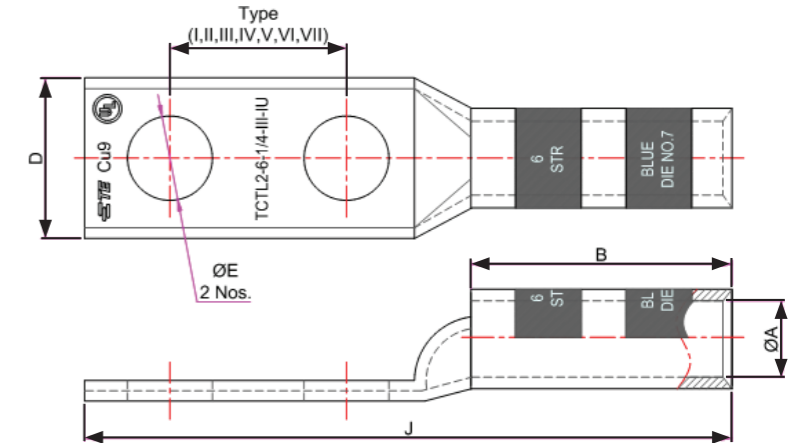

### Dual Rated Aluminum Crimp Lugs - Two Holes

Description	Conductor AWG/MCM	Dimensions mm (inch)													
		E (Stud Hole)		Centre Distance		A (Internal Dia)		C (Outer Dia)		B (Barrel Length)		D (Palm Width)		J (Total Length)	
TATL2-1/0-3/8-U	1/0 AWG	10.2	(3/8)	44.5	(1.75)	10.67	(0.42)	16.26	(0.64)	38.1	(1.5)	22.36	(0.88)	134.12	(5.28)
TATL2-1/0-1/2-U	1/0 AWG	13.2	(1/2)	44.5	(1.75)	10.67	(0.42)	16.26	(0.64)	38.1	(1.5)	22.36	(0.88)	134.12	(5.28)
TATL2-2/0-3/8-U	2/0 AWG	10.2	(3/8)	44.5	(1.75)	11.2	(0.44)	17.53	(0.69)	38.1	(1.5)	24.2	(0.95)	139.7	(5.5)
TATL2-2/0-1/2-U	2/0 AWG	13.2	(1/2)	44.5	(1.75)	11.2	(0.44)	17.53	(0.69)	38.1	(1.5)	24.2	(0.95)	139.7	(5.5)
TATL2-3/0-3/8-U	3/0 AWG	10.2	(3/8)	44.5	(1.75)	12.45	(0.49)	19.31	(0.76)	38.1	(1.5)	26.93	(1.06)	139.7	(5.5)
TATL2-3/0-1/2-U	3/0 AWG	13.2	(1/2)	44.5	(1.75)	12.45	(0.49)	19.31	(0.76)	38.1	(1.5)	26.93	(1.06)	139.7	(5.5)
TATL2-4/0-1/2-U	4/0 AWG	13.2	(1/2)	44.5	(1.75)	13.72	(0.54)	22.1	(0.87)	49.28	(1.94)	30.23	(1.19)	152.4	(6.0)
TATL2-4/0-5/8-U	4/0 AWG	16.8	(5/8)	44.5	(1.75)	13.72	(0.54)	22.1	(0.87)	49.28	(1.94)	30.23	(1.19)	152.4	(6.0)
TATL2-250-1/2-U	250 MCM	13.2	(1/2)	44.5	(1.75)	15.24	(0.6)	23.12	(0.91)	49.28	(1.94)	31.75	(1.25)	152.4	(6.0)
TATL2-250-5/8-U	250 MCM	16.8	(5/8)	44.5	(1.75)	15.24	(0.6)	23.12	(0.91)	49.28	(1.94)	31.75	(1.25)	152.4	(6.0)
TATL2-300-1/2-U	300 MCM	13.2	(1/2)	44.5	(1.75)	16.51	(0.65)	25.66	(1.01)	57.15	(2.25)	35.06	(1.38)	166.63	(6.56)
TATL2-350-1/2-U	350 MCM	13.2	(1/2)	44.5	(1.75)	18.55	(0.73)	28.2	(1.11)	57.15	(2.25)	38.1	(1.5)	166.63	(6.56)
TATL2-350-5/8-U	350 MCM	16.8	(5/8)	44.5	(1.75)	18.55	(0.73)	28.2	(1.11)	57.15	(2.25)	38.1	(1.5)	166.63	(6.56)
TATL2-500-1/2-U	500 MCM	13.2	(1/2)	44.5	(1.75)	21.59	(0.85)	33.53	(1.32)	76.2	(3.0)	44.45	(1.75)	185.68	(7.31)
TATL2-500-5/8-U	500 MCM	16.8	(5/8)	44.5	(1.75)	21.59	(0.85)	33.53	(1.32)	76.2	(3.0)	44.45	(1.75)	185.68	(7.31)
TATL2-600-1/2-U	600 MCM	13.2	(1/2)	44.5	(1.75)	23.63	(0.93)	36.58	(1.44)	76.2	(3.0)	44.45	(1.75)	185.68	(7.31)
TATL2-750-1/2-U	750 MCM	13.2	(1/2)	44.5	(1.75)	26.42	(1.04)	38.1	(1.5)	85.86	(3.38)	44.45	(1.75)	209.55	(8.25)



te.com/energy

©2020 TE Connectivity. All Rights Reserved. EPP-3213-DDS-01/20

TE Connectivity and TE connectivity (logo) are trademarks. Other logos, product and/or company names might be trademarks of their respective owners. While TE has made every reasonable effort to ensure the accuracy of the information in this brochure, TE does not guarantee that it is error-free, nor does TE make any other representation, warranty or guarantee that the information is accurate, correct, reliable or current. TE reserves the right to make any adjustments to the information contained herein at any time without notice. TE expressly disclaims all implied warranties regarding the information contained herein, including, but not limited to, any implied warranties of merchantability or fitness for a particular purpose. The dimensions in this catalog are for reference purposes only and are subject to change without notice. Specifications are subject to change without notice. Consult TE for the latest dimensions and design specifications.

FOR MORE INFORMATION:  
TE Technical Support Centers

USA/Canada: +1 800-327-6996  
Brazil: +55 11-2103-6023  
Mexico: +52 55-1106-0800  
South America: +57 1-319-8962