

Contact layout for UTO, UTOW & UTS female connectors

Shell size	Contacts : Size and quantity				UTO	UTOW	UTS	Insert with ground contact	Insert position in shell				Drilling Hole Pattern drawing (N insert position)
	#20	#16	#12	#8					W	X	Y	Z	
10	2		2		102W2		102W2		-	-	-	-	UTO-DHP-002-C01
		3			103		103	X	-	-	-	-	
	3	3			103W3		103W3		-	-	-	-	
		4			104		104		45°	-	-	-	
		4			1044				45°	-	-	-	
12	6					106	106		90°	-	-	-	UTOW-DHP-003-C01
	4				124		124	X	-	-	-	45°	UTO-DHP-002-C01
	8				128		128		26°	-	-	-	UTO-DHP-002-C01
14	10					1210	1210		60°	155°	270°	295°	UTOW-DHP-003-C01
				3	142G1		142G1	X	-	-	-	-	UTO-DHP-002-C01
	7				147		147	X	-	-	-	-	
	4	4			148		148	X	-	-	-	-	
	12				1412		1412		60°	-	-	-	
12				1492		1492		49°	71°	145°	-		
16	19					1419	1419		30°	165°	315°	-	UTOW-DHP-003-C01
	26					1626			60°	-	275°	338°	UTOW-DHP-003-C01
18				4			183G1	X	-	-	-	-	UTO-DHP-002-C01
		3		2			18X2M3		-	-	-	-	
	23				1823		1823		-	158°	-	270°	
20	32					1832	1832		85°	138°	222°	265°	UTOW-DHP-003-C01
	28				2028				79°	-	259°	-	UTO-DHP-002-C01
	30				2030				34°	90°	123°	259°	UTO-DHP-002-C01
22	41					2041			45°	126°	225°	-	UTOW-DHP-003-C01
	35				2235				13°	162°	198°	265°	UTO-DHP-002-C01
	38				2238				15°	47°	150°	331°	UTO-DHP-002-C01
24	55					2255			30°	142°	226°	314°	UTOW-DHP-003-C01
	48				2448				60°	120°	189°	351°	UTO-DHP-002-C01
	61					2461			90°	180°	270°	324°	UTOW-DHP-003-C01

- 1- Typical mating face of pin insert shown(Socket insert opposite). "N" normal position 0 Polarization letters show master key position with respect to contact hole
- 2- Unless otherwise specified "N" keyway is standard position on all keyways. Angles given are counter clockwise from "N"(Socket insert opposite) in

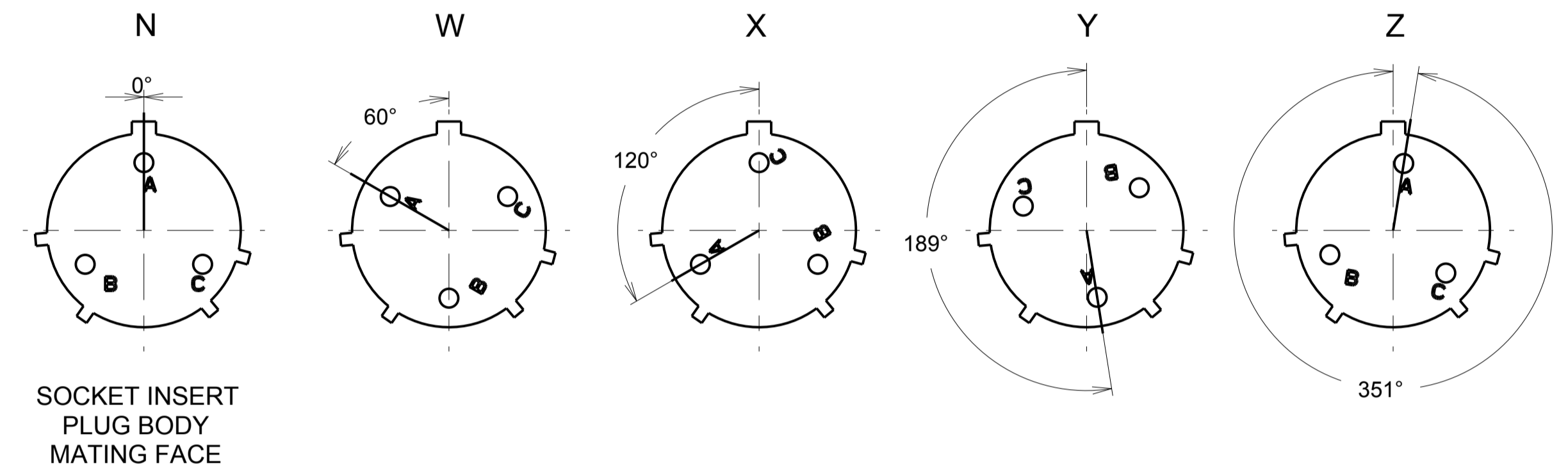

CUSTOMER DRAWING

f	15/04/2014	Add new arrangement: 10 44	
ISS	DATE	Latest modification - by:	LANDAIS.P
Designed by:	BERGER L.	Date:	09/02/04
Checked by:	SEE DISTRIBUTION LIST	Date:	SEE DISTRIBUTION LIST
TITLE	FEMALE CONNECTOR UTO, UTOW and UTS		
Scale	General angular 5/1	Tolerances: ± --	MATERIAL
SOURIAU	General linear Tolerances: ±0.1	General machining surface texture	Geometrical Tolerances See NF E 04-552
	SOURIAU Route Nationale 23 72470 CHAMPAGNE Tel. (33)02.43.54.35.00		PROJECT MSKI
FORMAT	SOURIAU DRG N° UTO-CONTACT-L-C02		SHEET 1 / 3

f : 0 : RL

SIZE 10

102W2

2 \varnothing 2.4 (#12)
2 \varnothing 1.0 (#20)

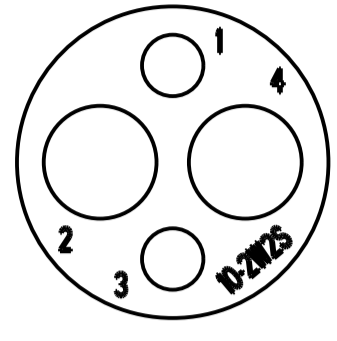

103

3 \varnothing 1.6 (#16)

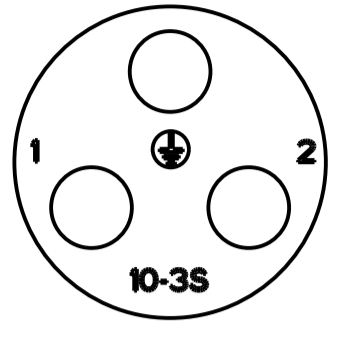

103W3

3 \varnothing 1.6 (#16)
3 \varnothing 1.0 (#20)

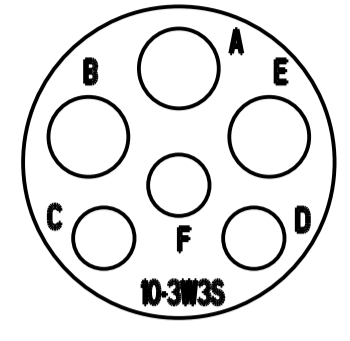

104

4 \varnothing 1.6 (#16)

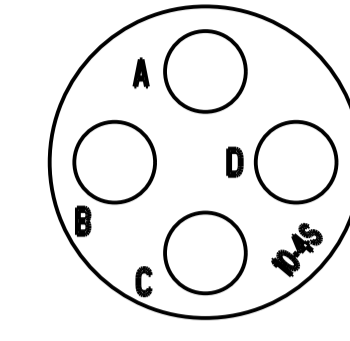

1044

4 \varnothing 1.6 (#16)

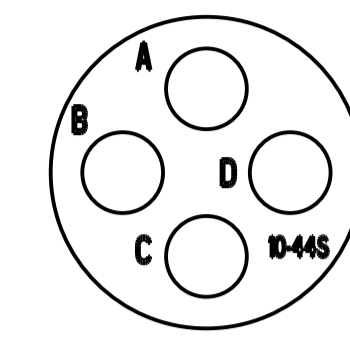

106

6 \varnothing 1 (#20)

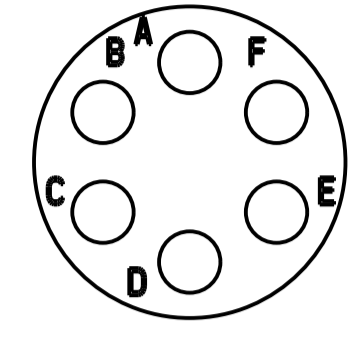

SIZE 12

124

4 \varnothing 1.6 (#16)

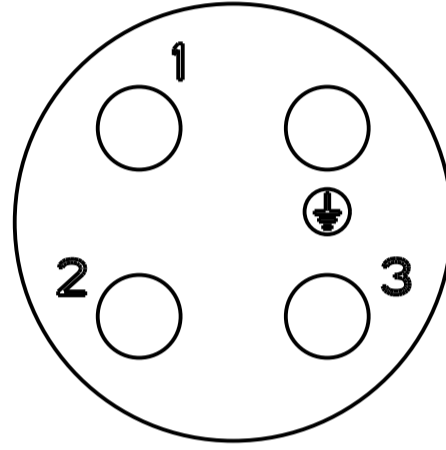

128

8 \varnothing 1.6 (#16)

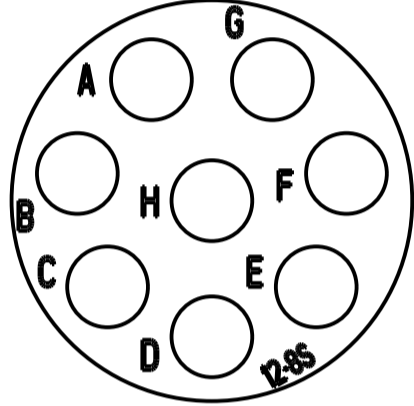

1210

10 \varnothing 1 (#20)

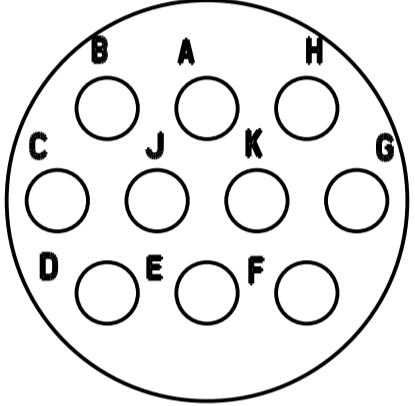

SIZE 14

142G1

3 \varnothing 3.6 (#8)

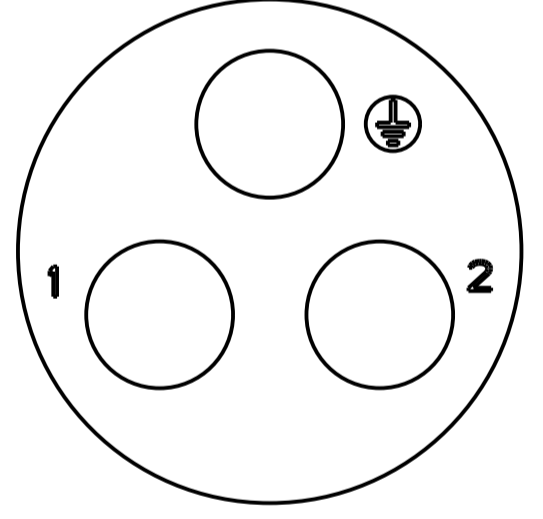

147

7 \varnothing 1.6 (#16)

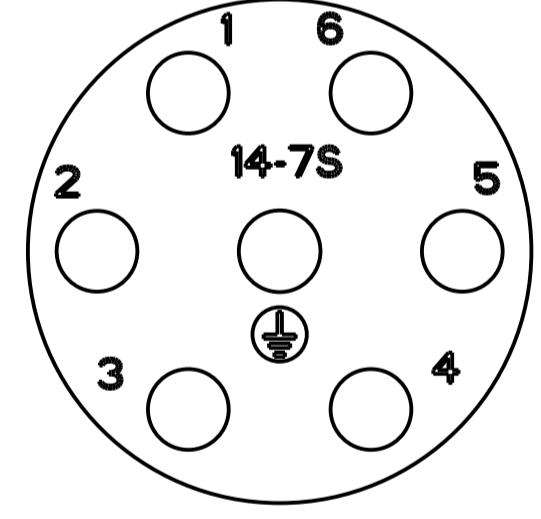

148

4 \varnothing 3.2 (#12)
4 \varnothing 1.6 (#16)

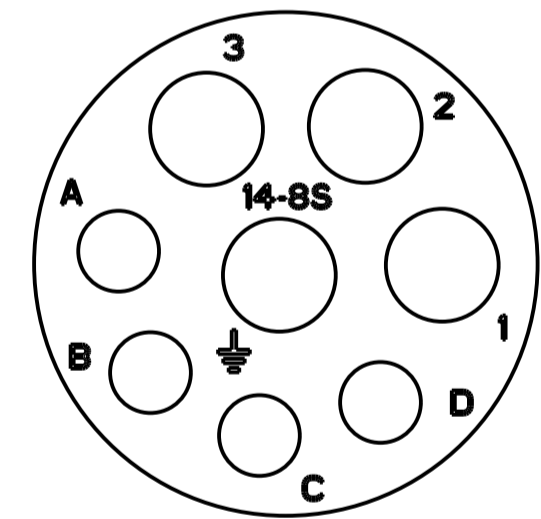

1412

12 \varnothing 1.6 (#16)

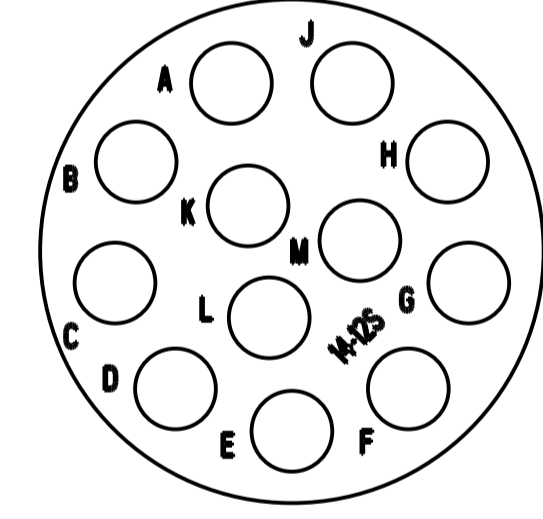

1492

12 \varnothing 1.6 (#16)

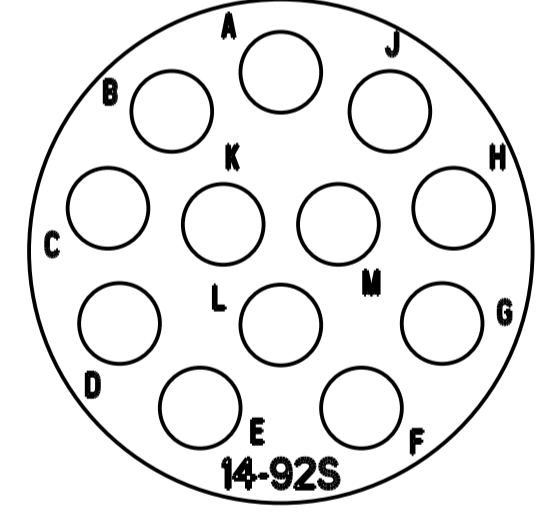

1419

19 \varnothing 1 (#20)

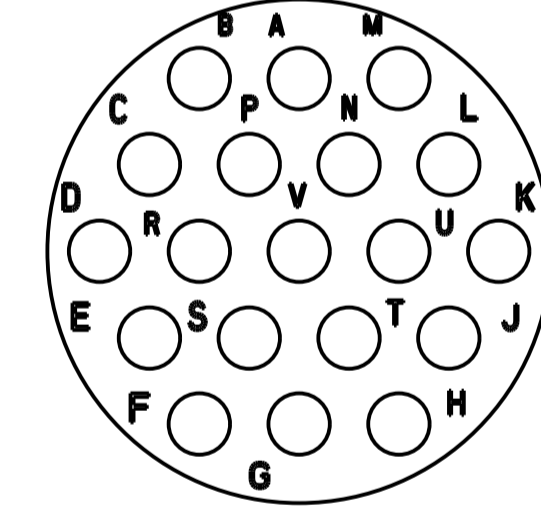

SIZE 16

1619

19 \varnothing 1.6 (#16)

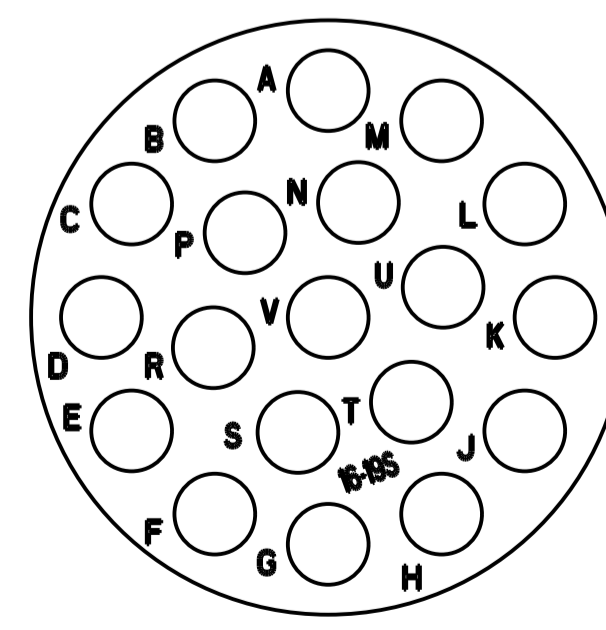

1626

26 \varnothing 1 (#20)

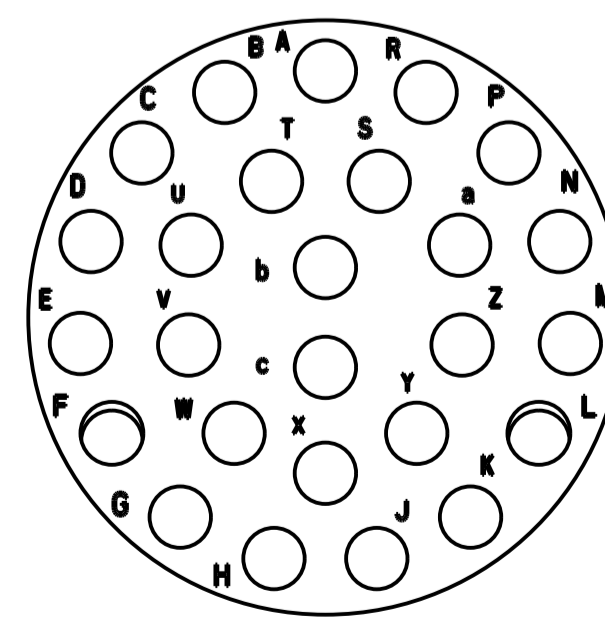

CUSTOMER DRAWING

P/N		---	
f	15/04/14	Add new arrangement : 10-44	---
ISS	DATE	Latest modification - by:	LANDAIS.P
DESIGNED BY:	BERGER L.	DATE:	09/02/04
TYPE OF DRAWING:	CUSTOMER	PROJECT:	MSKI
CHECKED BY:	SEE DISTRIBUTION LIST	DATE:	SEE DISTRIBUTION LIST
TITLE	FEMALE CONNECTOR UT0, UTOW and UTS		
SCALE	General angular	MATERIAL ---	
1/2	Tolerances: $\pm 1^\circ$	---	
	General linear	General machining	Ra 3.2
	Tolerances: ± 0.1	surface texture	See NF EN ISO 1101
		SOURIAU Route Nationale 23 72470 CHAMPAGNE Tel. (33)02.43.54.35.00	
This document is the property of SOURIAU It must not be reproduced or communicated without permission			
FORMAT	DRAWING REFERENCE		SHEET
A1	UTO-CONTACT-L-C02		2 / 3

SIZE 18

1823

23 \varnothing 1.6 (#16)

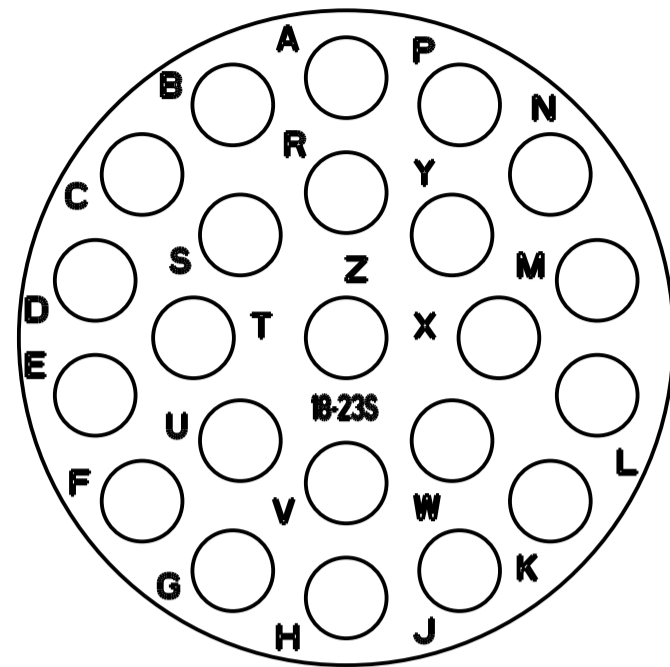

1832

32 \varnothing 1 (#20)

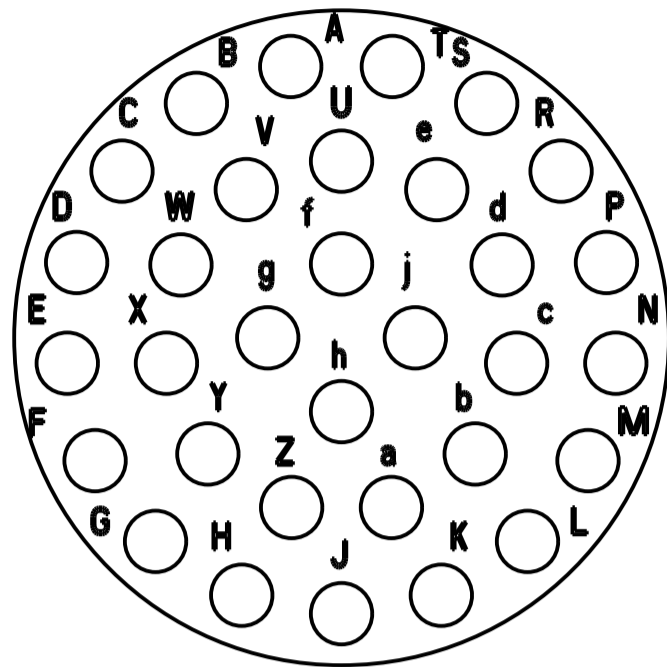

183G1

4 \varnothing 3.6 (#8)

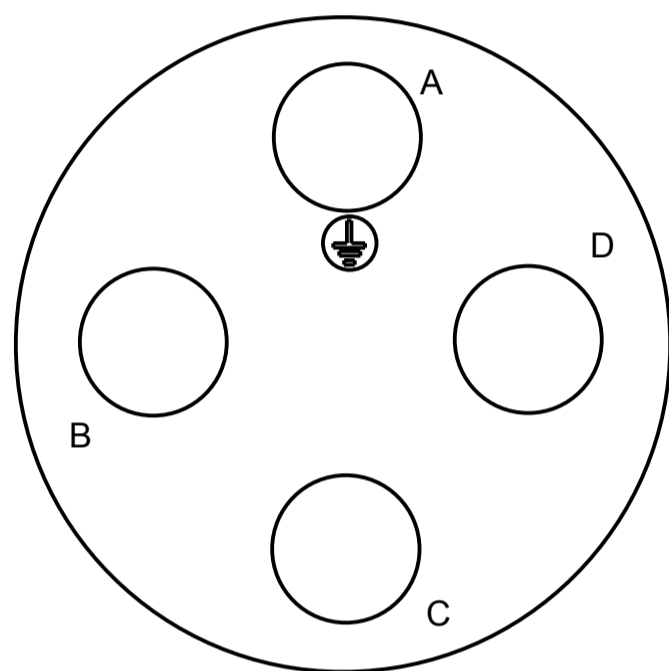

18X2M3

2 \varnothing 3.6 (#8)
3 \varnothing 1.6 (#16)

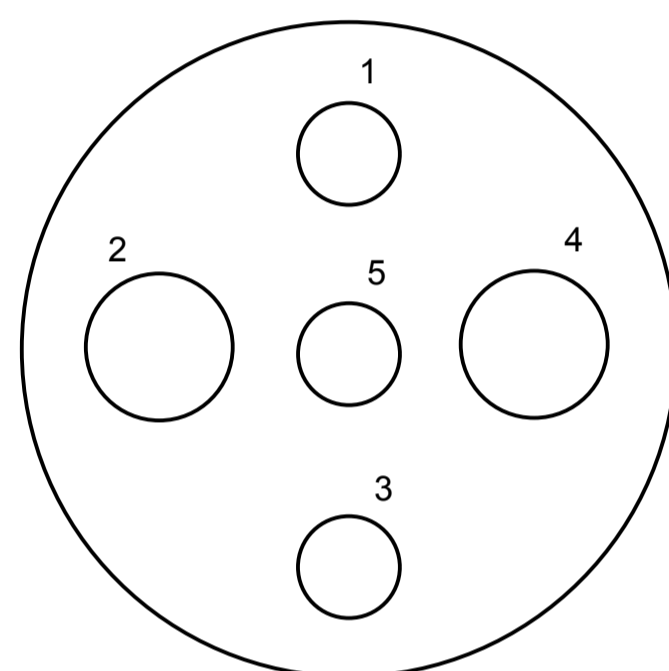

SIZE 20

2028

28 \varnothing 1.6 (#16)

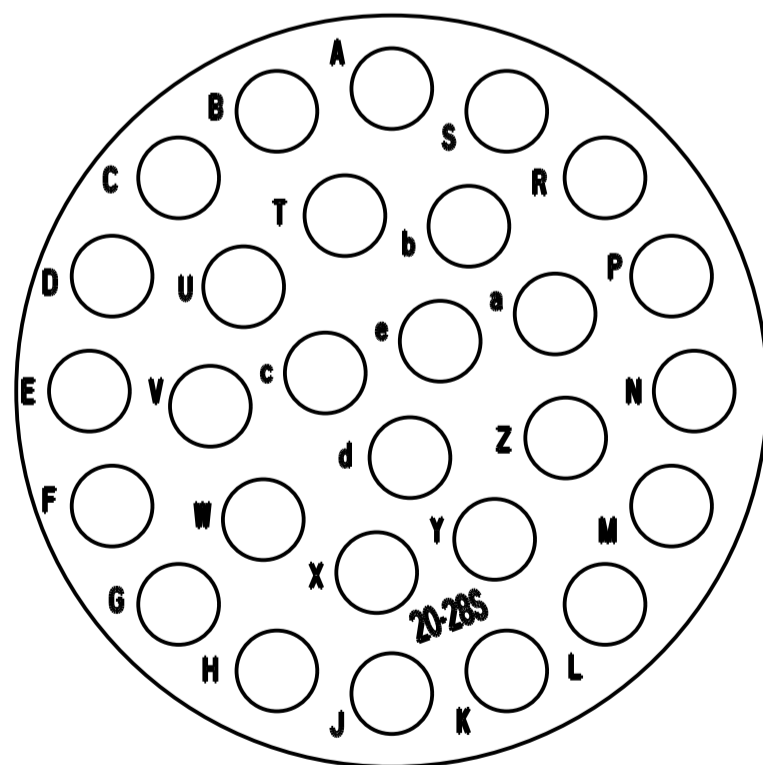

2030

30 \varnothing 1.6 (#16)

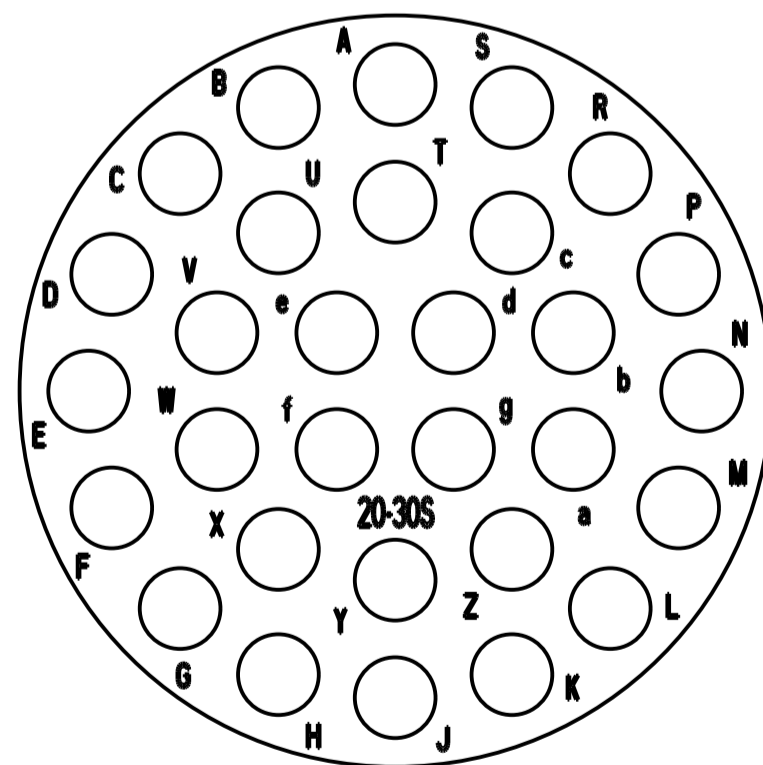

2041

41 \varnothing 1 (#20)

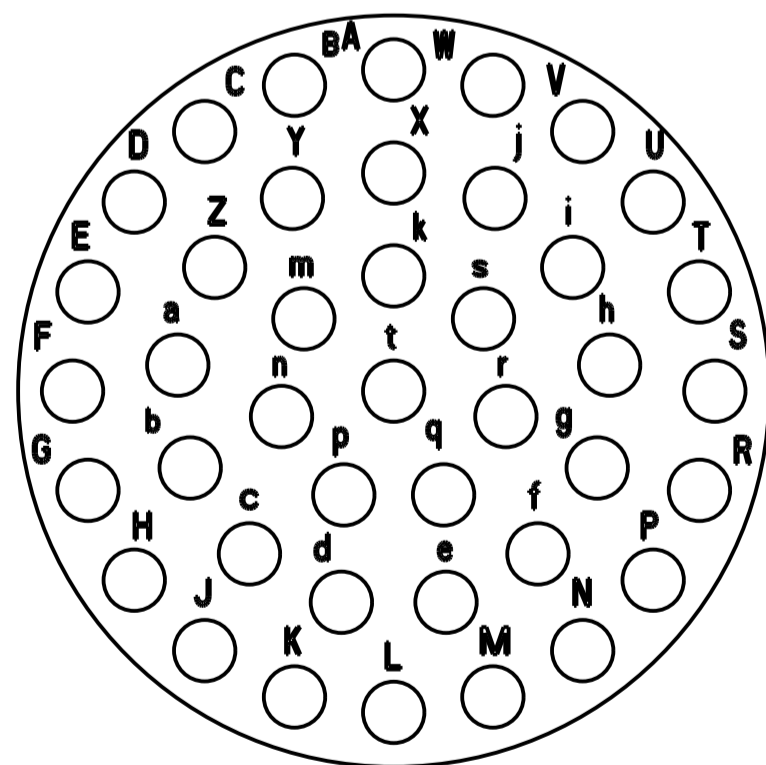

SIZE 22

2235

35 \varnothing 1.6 (#16)

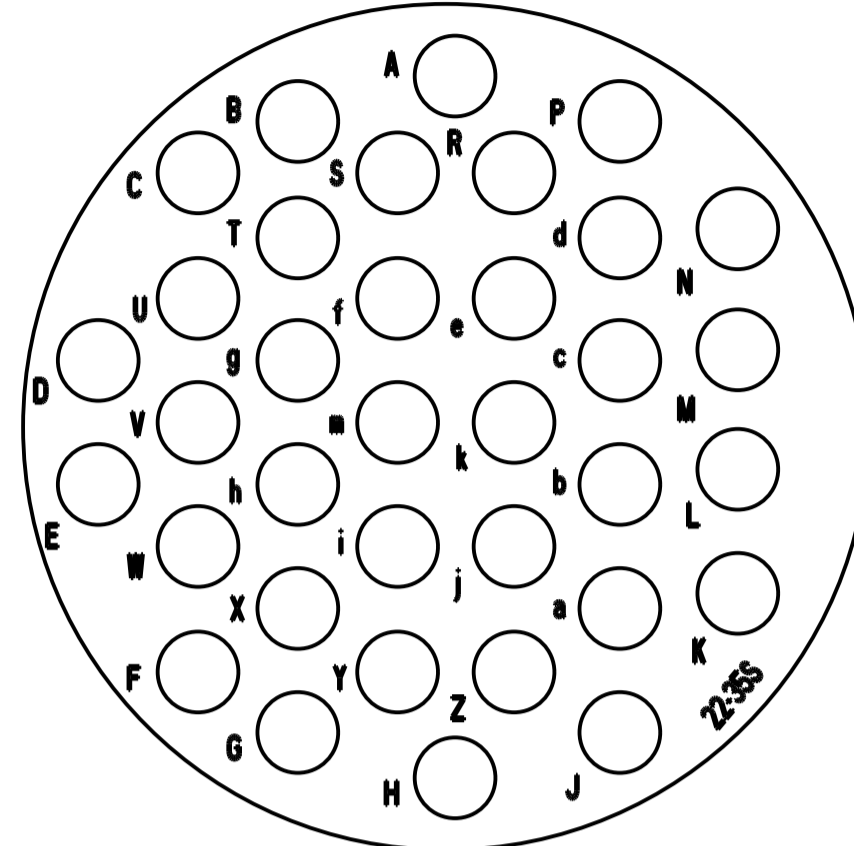

2238

38 \varnothing 1.6 (#16)

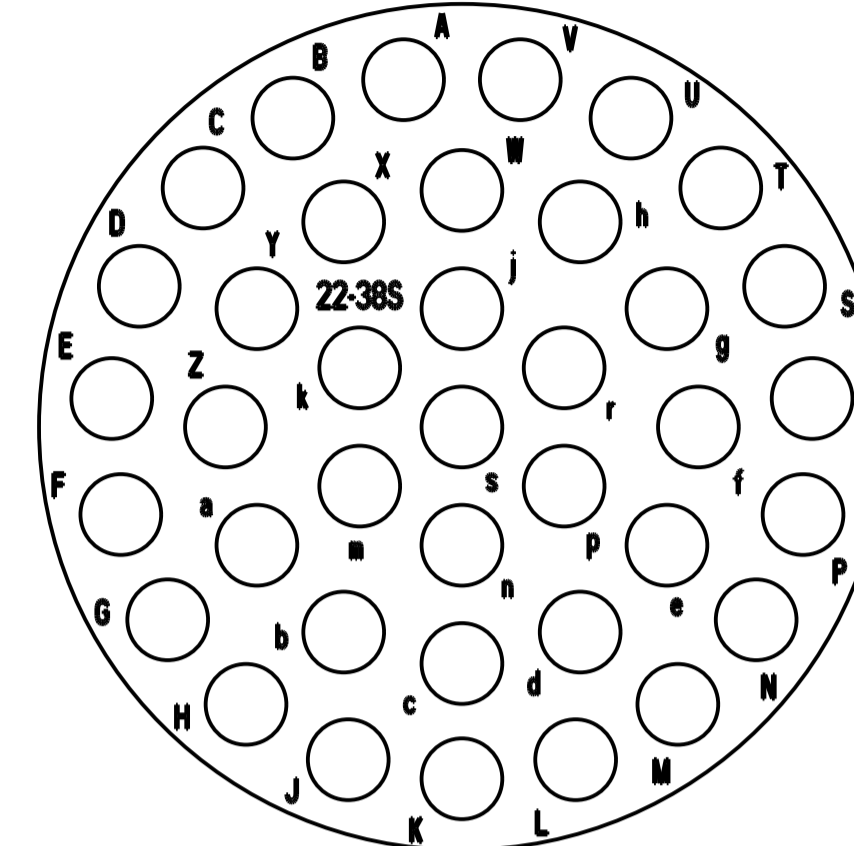

2255

55 \varnothing 1 (#20)

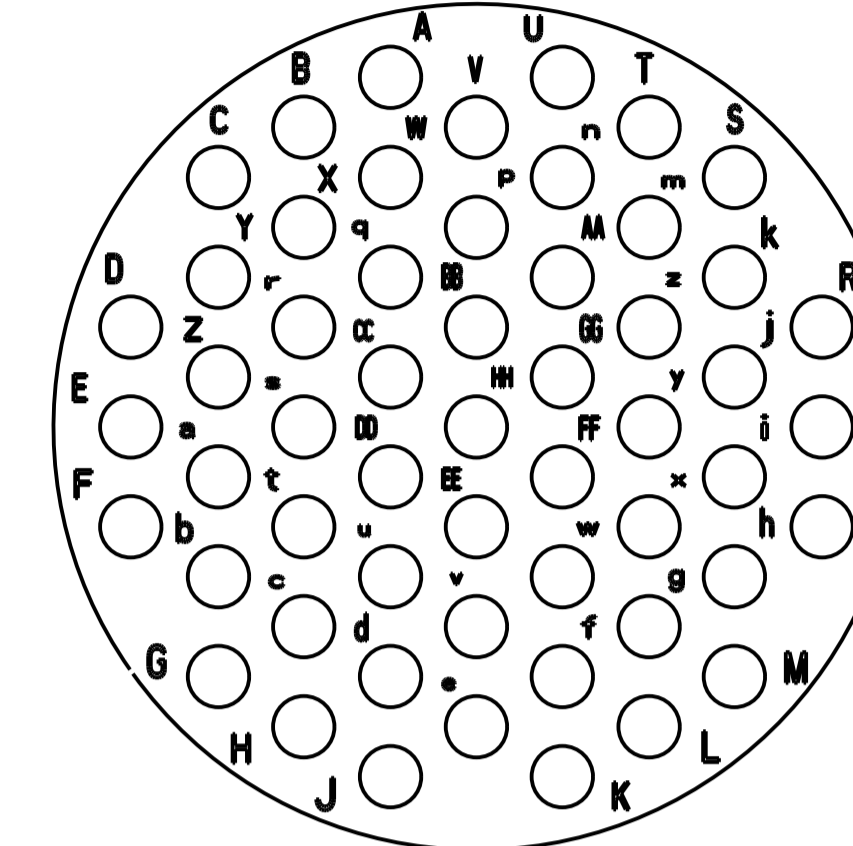

SIZE 24

2448

48 \varnothing 1.6 (#16)

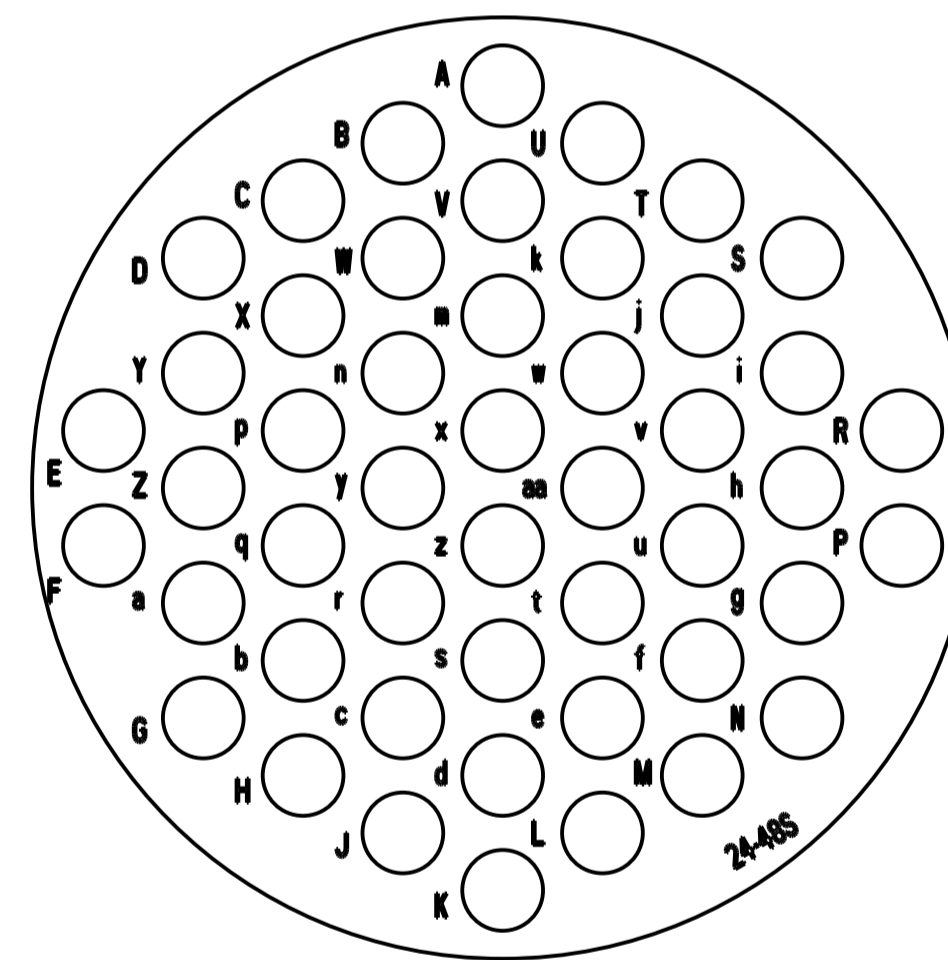

2461

61 \varnothing 1 (#20)

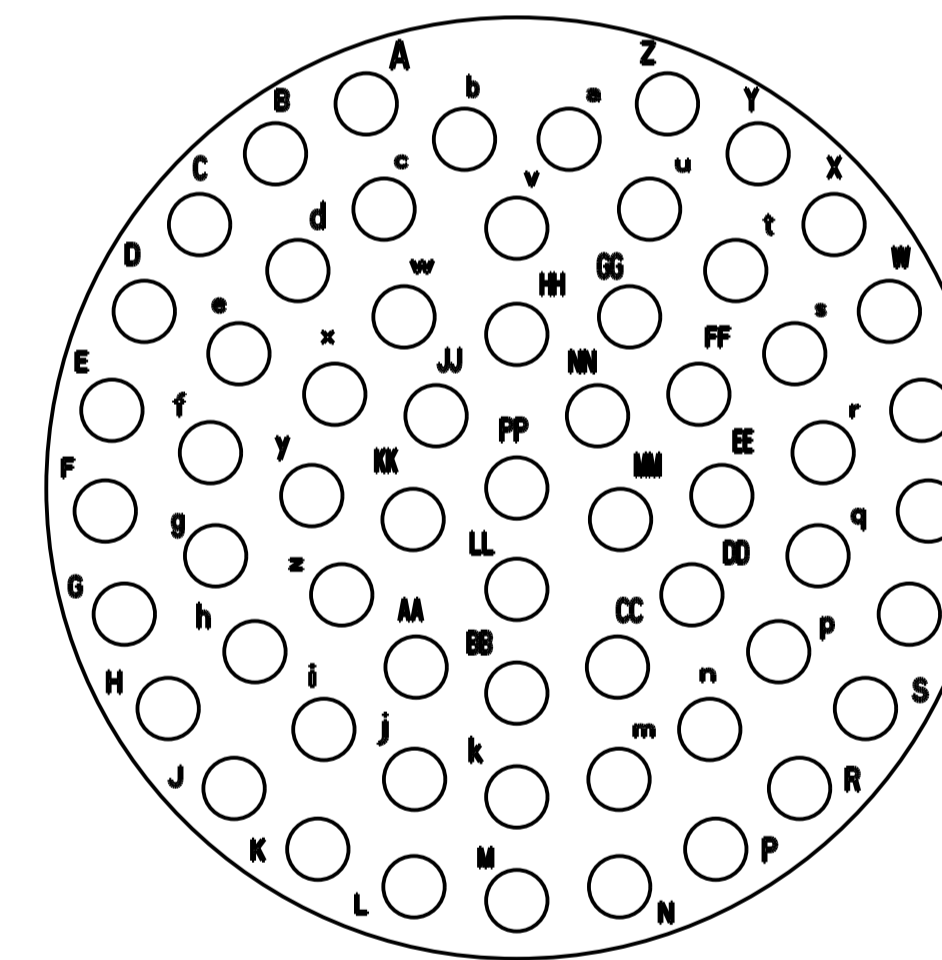

CUSTOMER DRAWING

P/N		---	
f	15/04/14	Add new arrangement : 10-44	---
ISS	DATE	Latest modification - by:	LANDAIS.P
Designed by:	BERGER L.	Date:	09/02/04
Checked by:	SEE DISTRIBUTION LIST	Date:	SEE DISTRIBUTION LIST
TITLE		FEMALE CONNECTOR UT0, UTOW and UTS	
Scale	General angular	MATERIAL --	
1/2	Tolerances: \pm 1°	---	
	General linear	General machining	Ra 3.2
	Tolerances : \pm 0.1	surface texture	See NF EN ISO 1101
PROJECT		MSKI	
SOURIAU		This document is the property of SOURIAU	
Route Nationale 23		It must not be reproduced or communicated without permission	
72470 CHAMPAGNE			
Tel. (33)02.43.54.35.00			
FORMAT	DRAWING REFERENCE		SHEET
A1	UTO-CONTACT-L-C02		3 / 3