

# INSTRUCTION SHEET

## MICROSmart

FC6A Series  
CPU module

CAN J1939 All-in-One type

This sheet provides brief operating instructions of the MicroSmart programmable controller. For details, see the MicroSmart User's Manual.

### Safety Precaution

Special expertise is required to use the MicroSmart.

- Read this instruction sheet and the user's manual to make sure of correct operation before starting installation, wiring, operation, maintenance, and inspection of the MicroSmart. Keep this instruction sheet where it can be accessed by the end user.
- All MicroSmart modules are manufactured under IDEC's rigorous quality control system, but users must add backup or failsafe provisions to control systems use the MicroSmart in applications where heavy damage or personal injury may be caused if the MicroSmart should fail.
- Install the MicroSmart according to the instructions described in this instruction sheet and the user's manual. Improper installation will result in falling, failure, or malfunction of the MicroSmart.
- Make sure that the operating conditions are as described in the user's manual. If you are uncertain about the specifications, contact IDEC before using the MicroSmart.
- In this instruction sheet, safety precautions are categorized in order of importance from Warning and Caution:

### WARNING

Warning notices are used to emphasize that improper operation may cause severe personal injury or death.

### CAUTION

Caution notices are used where inattention might cause personal injury or damage to equipment.

### WARNING

- Turn off the power to the MicroSmart before starting installation, removal, wiring, maintenance, or inspection on the MicroSmart.
- Failure to turn off the power may cause electrical shocks or fire hazard. Emergency stop and interlocking circuits must be configured outside the MicroSmart. If such a circuit is configured inside the MicroSmart, failure of the MicroSmart may cause disorder of the control system, damage, or accidents.

### CAUTION

- The MicroSmart is designed for installation in equipment. Do not install the MicroSmart outside of equipment.
- Install the MicroSmart in environments as described in the user's manual. If the MicroSmart is used in places where it is subjected to high-temperature, high-humidity, condensation, corrosive gases, excessive vibrations, or excessive shocks it will result in electrical shocks, fire hazard, or malfunction.
- The environment rating for using the MicroSmart is "Pollution degree 2."
- Prevent metal fragments and pieces of wire from dropping inside the MicroSmart housing. Ingress of such fragments and chips may cause fire hazard, damage, or malfunction.
- Use wires of a proper size to meet voltage and current requirements. Tighten terminal screws to the proper tightening torque of 0.51 N·m or 0.49 N·m.
- Use an IEC60127-approved fuse on the power line and output circuit to meet voltage and current requirements.

(Recommended fuse: Littelfuse 5×20mm slow-blow type 218000 series/Type T) This is required when exporting equipment containing MicroSmart to Europe.

- Use an EU-approved circuit breaker. This is required when exporting equipment containing MicroSmart to Europe.
- If relays or transistors in the MicroSmart output modules should fail, outputs may remain on or off. For output signals which may cause heavy accidents, provide a monitor circuit outside of the MicroSmart.
- Do not disassemble, repair, or modify MicroSmart modules.

<Handling of Batteries and Devices with Built-in Batteries in EU Member States>  
Note) The following symbol mark is for EU countries only.



This symbol mark means that batteries and accumulators, at their end-of life, should be disposed of separately from your household waste. If a chemical symbol is printed beneath the symbol shown above, this chemical symbol means that the battery or accumulator contains a heavy metal at a certain concentration. This will be indicated as follows:

Hg : Mercury (0.0005%) Cd : Cadmium (0.002%) Pb : Lead (0.004%)

In the European Union there are separate collection systems for used batteries and accumulators. Please dispose of batteries and accumulators correctly in accordance with each country or local regulation.

### 1 Type

CPU module CAN J1939 All-in-One type (40-I/O Type)

Power Supply Type	Output Type	Type No.
100-240VAC	Relay	FC6A-C40R1AEJ
24VDC	Relay	FC6A-C40R1CEJ
	Transistor Sink	FC6A-C40K1CEJ
	Transistor Protect Source	FC6A-C40P1CEJ
12VDC	Relay	FC6A-C40R1DEJ
	Transistor Sink	FC6A-C40K1DEJ
	Transistor Protect Source	FC6A-C40P1DEJ

### 2 Specification

Operating Temperature: -10 to +55°C, Storage Temperature: -25 to +70°C (no freezing)  
Relative/Storage Humidity: 10 to 95%RH (no condensation),  
Altitude: 1013 to 795hPa (0 to 2,000 m) during operation 1013 to 701hPa (0 to 3,000 m) during transport,  
Vibration Resistance: 5 to 8.4 Hz half amplitude 3.5 mm, 8.4 to 150 Hz, acceleration 9.8 m/s<sup>2</sup> (1 G), X, Y, Z directions, 2 hours,  
Shock Resistance: 147 m/s<sup>2</sup> (15 G), 11 ms, X, Y, Z, 3 axes, 6 directions, 3 times each  
\*See the user's manual for more details on the product specifications.

### 3 Name & Function

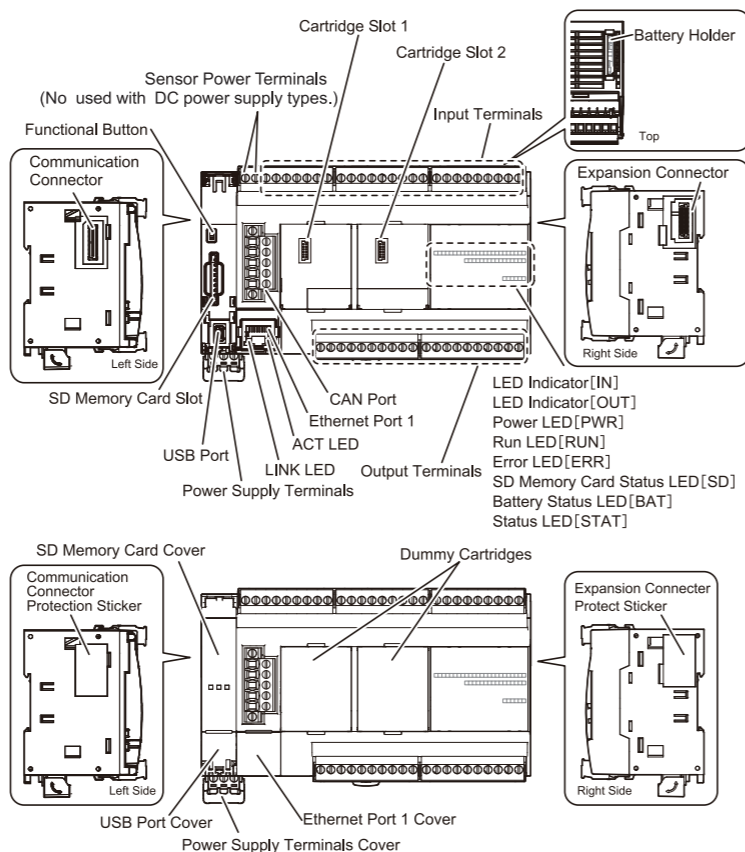

### 4 Assembling Modules

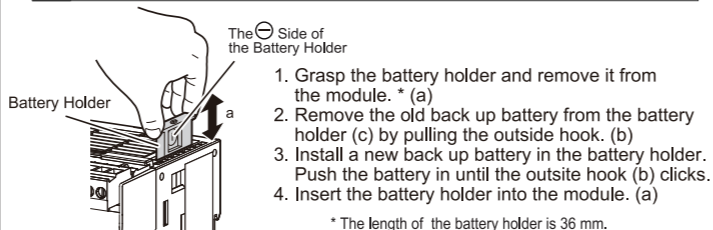

\* The length of the battery holder is 36 mm.

### CAUTION

- Change the battery before the old battery expires.
- Do not change the battery when the MicroSmart is power ON. Doing so may damage the product.
- Change the battery within 1 minute of turning off the power supply, or the device value will be reset to its initial values.

### 5 Default Setting of the Function Switch

- The default setting of the function switch is 0.
- The PLC will not run if the function switch is 0 when Run/Stop PLC by Function Switch is enabled in WindLDR and a program is downloaded with Automatic start after download enabled. To run the PLC, the function switch must be set to 1.

\* Enabled is the default setting for Run/Stop PLC by Function Switch in WindLDR.  
\* For details on the function switch, see the user's manual.

### 6 Mounting Modules

For details about mounting and removing modules, see the user's manual.

[Mounting on DIN Rail]

Use a 35-mm-wide DIN Rail and BNL6 mounting clips to secure the modules.

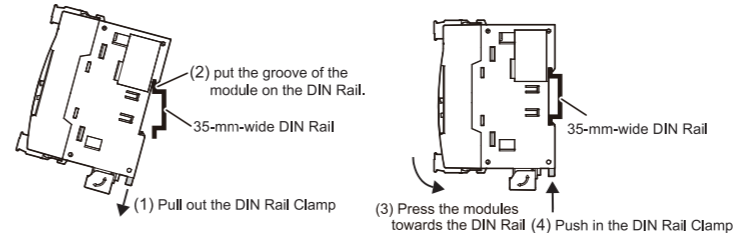

[Direct Mounting on Panel Surface]

Pull out the DIN Rail clamp on the back of the module and insert the direct mounting clamp (FC6A-PSP1PN05) into the slot. Attach the module to the mounting plate using the screw holes. Attach the module to the mounting plate using M4 tapping screws, as shown below, or make 5 to 6mm mounting holes and secure the module using M4 pan head screws. Always give sufficient consideration to operability, ease-of-maintenance, and environmental resistance when deciding on the mounting position.

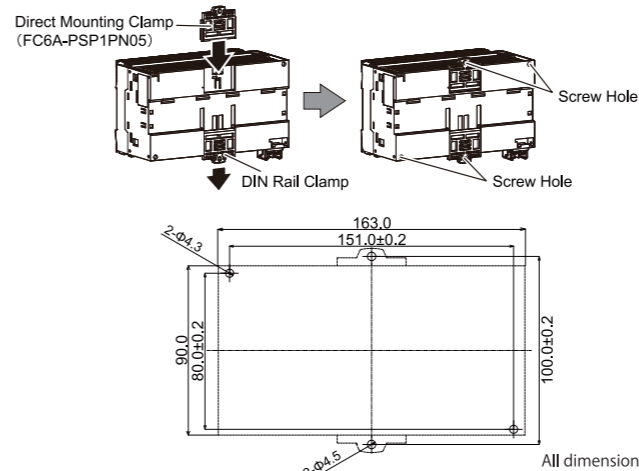

### 7 Installation in Control Panel & Mounting Direction

Mount the FC6A MicroSmart as follows. To provide ample ventilation, ensure that there is sufficient space between the FC6A MicroSmart and other devices, heat sources, and panel surfaces.

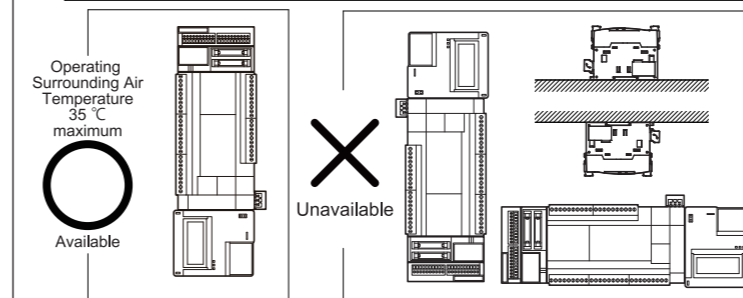
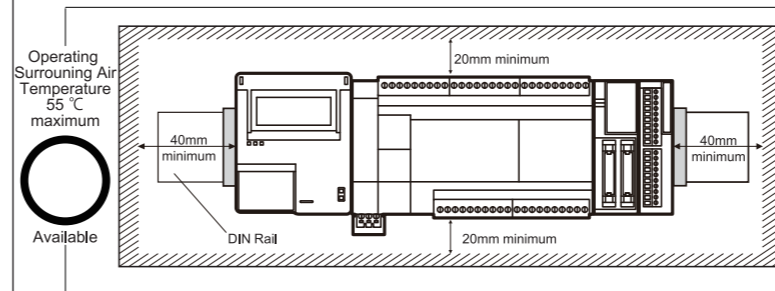

### 8 Dimensions

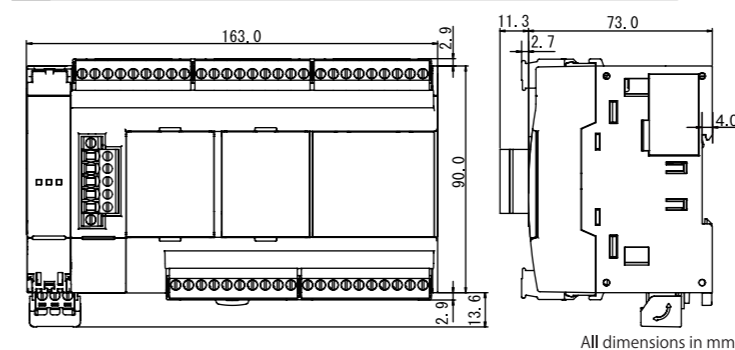

\*See the user's manual for more details on the dimensions.

### 9 Wiring

DC Sink Input Wiring

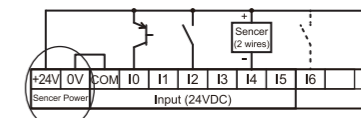

DC Source Input Wiring

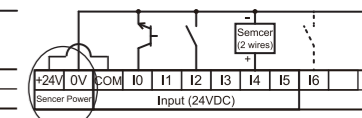

100-240VAC power supply type: Support of sensor power which is in the circle area of above figure is able to be used instead of 24VDC external power.

24VDC power supply type: No support of sensor power. Therefore 24VDC external power is required.

12VDC power supply type: No support of sensor power. Therefore 12VDC external power is required.

DC Power Wiring

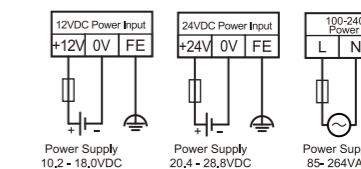

AC Power Wiring

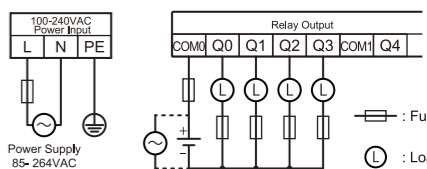

Relay Output Wiring

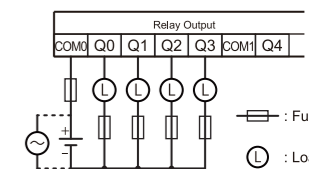

Transistor Sink Output Wiring

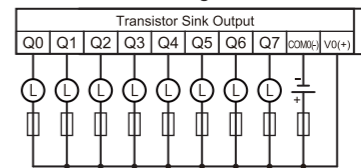

Transistor Protect Source Output Wiring

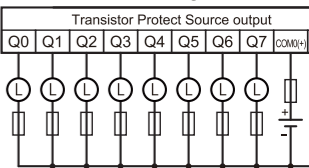

\*See the user's manual for more details on the wiring.

### 10 CAN Port (SAE J1939)

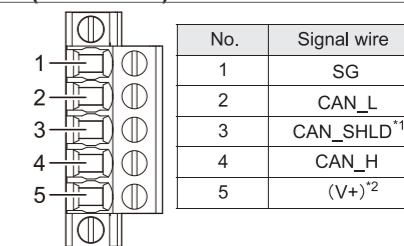

Cable	Cable Type	J1939-11	J1939-15
		Twisted pair Cable	
	Shielded	Unshielded	
	Standards	ISO 11898/1993	
	Characteristic impedance	120Ω	

\*1 This port is connected to SG inside via resistor and capacitor connected in series (R = 1Ω, C = 0.68μF)  
\*2 This port is N.C. Not connect to inside.  
\*3 Use Termination resistors (120Ω, 0.5 W or higher) at the both ends of the network.

### 11 Applicable Ferrule Dimensions

The recommended ferrule is made by Phoenix Contact. To crimp the ferrules shown below, use a special crimping tool (CRIMPFOX 6 (1212034) )

Power supply Terminals, Input Terminals and Output Terminals:  
AI 0,25- 6 (3203040) , AI 0,25- 8 (3203037) , AI 0,34- 6 (3203053) , AI 0,34- 8 (3203066) , AI 0,5- 6 (3200687) , AI 0,5- 8 (3200014) , AI 0,5- 8 GB (1208966) , AI 0,75- 6 (3200690) , AI 0,75- 8 (3200519) , AI 1-8 (3200030) , AI 1,5- 6 (3200755) , AI 1,5- 8 (3200043) , AI-TWIN 2 × 0,5- 8 (3200933) , AI-TWIN 2 × 0,75- 8 (3200807) , AI-TWIN 2 × 1,5- 8 (3200823)

CAN Port:  
AI 0,25-10 (3241128) , AI 0,34-10 (3241129) , AI 0,5-10 (3201275) , AI 0,5-10 GB (3203150) , AI 0,75-10 (3201288) , AI 1-10 (3200182) , AI 1,5-10 (3200195) , AI-TWIN 2 × 0,5-10 (3203309) , AI-TWIN 2 × 0,75-10 (3200975)

( ) indicates the Type No. of PHOENIX CONTACT GmbH & Co. KG

### 12 Recommended Screwdriver

To wire the terminal block, use the recommended screwdriver made by Phoenix Contact and tighten terminal screws to the proper tightening torque.

Power supply Terminals, Input Terminals and Output Terminals:  
Screwdriver : SZS 0,6×3,5 (1205053) / Tighten torque : 0.51 N·m

CAN Port:  
Screwdriver : SZS 0,6×3,5 (1205053) / Tighten torque : 0.49 N·m

( ) indicates the Type No. of PHOENIX CONTACT GmbH & Co. KG

MicroSmart User's manual can be downloaded from <http://www.idec.com/download>