

## SKINDICHT® SHVE-M

SKINDICHT® SHVE-M, metric brass cable gland with high degree of protection, low-resistance 360° screen contact and high strain relief

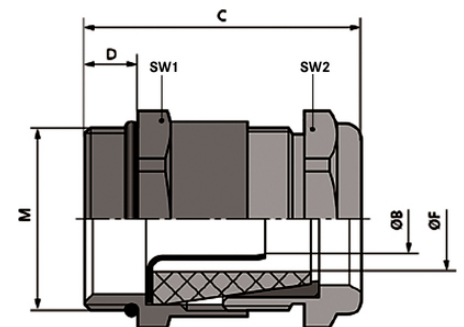

Optimum strain relief

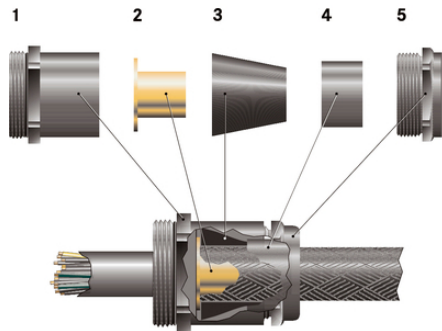

Interference signals



Waterproof

### Benefits

Optimum, low-resistance 360° screen contact  
High degree of protection  
High strain relief

### Application range

Earthing gland, for applications where electrical interference fields can occur.  
Medical engineering  
Frequency converters  
Airports  
Measurement and control technology

### Product Make-up

- 1 fitting
- 2 earth sleeves
- 3 sealing cones
- 4 cone, brass
- 5 compression screws

### Note

Counter nut to be used: SKINDICHT® SM-M

Last Update (20.08.2020)

©2020 Lapp Group - Technical changes reserved

Product Management [www.lappkabel.de](http://www.lappkabel.de)

You can find the current technical data in the corresponding data sheet.

PN 0456 / 02\_03.16

## SKINDICHT® SHVE-M

SKINDICHT® SM-PE-M counter nut should be used to ensure optimum contact with painted, anodised or powder-coated housings

For more EMC cable glands, refer to SKINTOP® MS-SC-M and MS-M BRUSH, and compatible counter nut SKINDICHT® SM-PE-M

Example order identification:

SHVE-M 20 / 16 / 15 / 11

20 = Connection thread metric

16 = Function thread PG

15 = Clear width of sealing cone (F)

11 = Clear width of earthing sleeve (B)

### Technical Data

Classification ETIM 5:

ETIM 5.0 Class-ID: EC000441

ETIM 5.0 Class-Description: Cable screw gland

Classification ETIM 6:

ETIM 6.0 Class-ID: EC000441

ETIM 6.0 Class-Description: Cable screw gland

Caution:

The installation dimensions  
can be found in appendix T21

Material:

Body: nickel-plated brass  
Earthing sleeve: blank brass  
Sealing cone: CR  
O-ring: NBR

Protection rating:

IP 68 - 10 bar

Temperature range:

-20°C to +80°C

### Note

Photographs and graphics are not to scale and do not represent detailed images of the respective products.

Prices are net prices without VAT and surcharges. Sale to business customers only.

**SKINDICHT® SHVE-M**

Article number	Article designation / size	Function thread PG	Outer sheath clamping range ØF mm	Inner sheath clamping range (mm)	SW1/SW2 mm	Overall length C mm	Thread length D mm	Clear opening earthing sleeve ØB	Clear opening F (mm)	Pieces / PU
SKINDICHT® SHVE-M										
52106860	M 16 x 1,5	9	4.5 - 5.8	2.2 - 3.2	18 / 17	26.5	5	3.2	6.0	25
52106870	M 16 x 1,5	9	4.5 - 6.8	2.2 - 3.2	18 / 17	26.5	5	3.2	7.0	25
52106880	M 16 x 1,5	9	5.5 - 5.8	2.6 - 3.6	18 / 17	26.5	5	3.6	6.0	25
52106890	M 16 x 1,5	9	5.5 - 6.8	2.6 - 3.6	18 / 17	26.5	5	3.6	7.0	25
52106910	M 20 x 1,5	11	3 - 6.8	3.5 - 4.5	22 / 20	31.0	6	4.5	7.0	25
52106920	M 20 x 1,5	11	6 - 8.8	3.5 - 4.5	22 / 20	31.0	6	4.5	9.0	25
52106930	M 20 x 1,5	13.5	6.5 - 8.8	3.5 - 5	22 / 22	32.0	6	5	9.0	25
52106940	M 20 x 1,5	13.5	6 - 8.8	4.5 - 6	22 / 22	32.0	6	6	9.0	25
52106950	M 20 x 1,5	13.5	8 - 10.8	5.5 - 7	22 / 22	32.0	6	7	11.0	25
52106960	M 20 x 1,5	16	8.5 - 10.8	6 - 8	24 / 24	34.5	6	8	11.0	25
52106970	M 20 x 1,5	16	10 - 12.8	7 - 9	24 / 24	34.5	6	9	13.0	25
52106980	M 20 x 1,5	16	10 - 12.8	8 - 10	24 / 24	34.5	6	10	13.0	25
52106990	M 20 x 1,5	16	12.5 - 14.8	9 - 11	24 / 24	34.5	6	11	15.0	25
52107000	M 25 x 1,5	21	13 - 15.8	10 - 12	30 / 30	39.0	7	12	16.0	25
52107010	M 25 x 1,5	21	13 - 15.8	11 - 13	30 / 30	39.0	7	13	16.0	25
52107020	M 25 x 1,5	21	15.5 - 17.8	12 - 14	30 / 30	39.0	7	14	18.0	25
52107030	M 25 x 1,5	21	15 - 17.8	13 - 15	30 / 30	39.0	7	15	18.0	25
52107040	M 25 x 1,5	21	17.5 - 19.8	14 - 16	30 / 30	39.0	7	16	20.0	25
52107050	M 32 x 1,5	29	19 - 21.8	15 - 17	40 / 40	45.5	8	17	22.0	10
52107060	M 32 x 1,5	29	18 - 23.8	16 - 18	40 / 40	45.5	8	18	22.0	10
52107070	M 32 x 1,5	29	20 - 23.8	17 - 19	40 / 40	45.5	8	19	24.0	10
52107080	M 32 x 1,5	29	23 - 25.8	17 - 19	40 / 40	45.5	8	19	26.0	10

Last Update (20.08.2020)

©2020 Lapp Group - Technical changes reserved

Product Management www.lappkabel.de

 You can find the current technical data in the corresponding data sheet:  
 PN 0456 / 02\_03\_16