

Bag Filter

FGF Series

RoHS

Optimum for the large flow filtration

The bag-stated element (made of non-woven cloth) makes it possible to filtrate the large flow with lower pressure drop.

[FGF□1 Series (one element included): Up to 400 L/min]

Easy maintenance

Replacement operations are easy thanks to a built-in basket mechanism allowing element replacement outside the vessel.

Main operating fluids

- Coolant (oil-based, water-soluble)
- Cutting fluid
- Industrial water
- Weak alkali-based cleaning fluid

* For other kinds of fluids, please contact SMC.

With safety mechanism

Employs proprietary SMC latch mechanism and band lock mechanism.

Safe even in the event of erroneous operation.

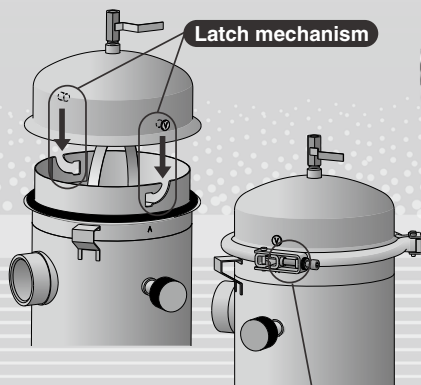

With band-lock mechanism

**Improved functionality and operability
Renewed for easier use!**

[FGF□1 Series (one element included)]

- Leg format changed to removable type, improved piping workability on bottom side.
- Easier handling thanks to lightweight band and hinge mechanism.
- Basket features hole for fluid release. Release of foreign matter to the outlet side is prevented.
- Weight: **13 kg** (Current model: 19 kg)
32% lighter than the current model

* Applies to FGF□1A



Bag-stated element



With a bag configuration, the aperture is wide and foreign matter is captured inside the element for easy removal. Furthermore, foreign matter captured inside the element will not spill over into the case interior or the surrounding area.

Select from a wide range of filtration accuracy.

Nominal filtration accuracy
5, 10, 25, 50, 100 μm

Variations

Series	Number of elements	Element size	Port size	Maximum flow (Water, at ΔP = 7 kPa)
FGF□1	1	∅190 x L440	Rc2	Approx. 400 L/min
FGF□3	3	∅190 x L770	4 ^B JIS10 ^K FF	Approx. 1200 L/min
FGF□5	5		6 ^B JIS10 ^K FF	Approx. 2000 L/min

FGD

FGE

FGG

FGA

FGC

FGF

FGH

FQ1

FN

EB□

ES□

Bag filter offers excellent safety performance and ease of maintenance.

With safety mechanism

Employs SMC proprietary latch mechanism – Prevents cover blowout in cases of erroneous operation.

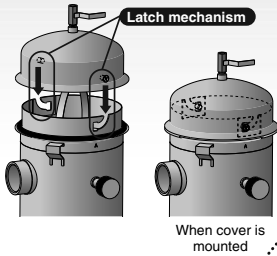

Band system

Makes the work of tightening easy.

Compared to a bolt tightening system with many places (between 4 and 6) that need to be tightened, this system is easy to use with only one place to tighten.

Improved, easier handling thanks to lightweight band

Easier handling with more lightweight band (Band weight: 1 kg)

With lock mechanism <Patent pending>

Safe lock mechanism prevents band from coming off even in cases of erroneous operation under internal pressure.

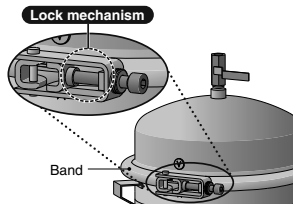

Element can be replaced outside the vessel.

Use of a built-in basket mechanism makes it possible to replace the element outside the vessel.

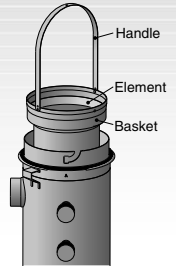

No-fluid-buildup structure

Basket features hole for fluid release. Release of foreign matter to the outlet side during element replacement is prevented.

Since there is no leftover fluid, there is no need to perform drainage operations.

(The drain port of the current model has been eliminated.)

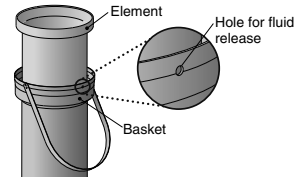

Lightweight

32% lighter than the current model

Weight: **13 kg** (Current model: 19 kg)

* Applies to FG□1A

Piping operations are a breeze.

With a removable leg system, carrying out piping operations at the fluid release port is easier.

Example When removing legs from the main unit before attaching piping

① Remove legs from the main unit.



② Attach piping to fluid release port.

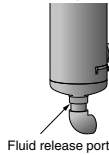

③ Replace legs on the main unit and attach piping to OUT port.

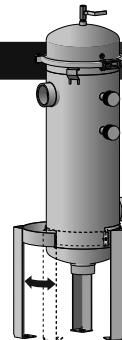
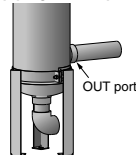

Variations of Bag Filters

Available combination between an element and a vessel

Element		Vessel		
		Standard products		
		FGF□1 Vessel with one element 0.5 MPa type	FGF□3 ^{Note 2)} Vessel with three elements 0.5 MPa type	FGF□5 ^{Note 2)} Vessel with five elements 0.5 MPa type
Made to Order	Standard elements	P.47	●	●
	Sub-element + Standard element	P.55	●	●
	Sub-element		●	●
	HEPO element	P.56	●	●
	Long service life element		●	●
	Branch type element	P.57	—	—
	PP (Polypropylene) bag element		●	●
Filter paper element	P.58	●	●	

- FGD
- FGE
- FGG
- FGA
- FGC
- FGF
- FGH
- FQ1
- FN
- EB
- ES

Note 1) Combinations between standard or made-to-order elements and standard or made-to-order vessels are marked (●) as above.
 Note 2) Please contact SMC for delivery time as the FGF3□ and FGF5□ are produced upon receipt of order.

Types of Element

Standard element		Made-to-Order elements					
Bag element	Sub-element + Standard element	X46	Sub-element	X81	HEPO element	X49	
P.47  (For coarse filtration)	P.55 Effective for extending the service life of a standard element  (For coarse filtration)		P.55 Eliminates large foreign matter.  (For coarse filtration)		P.56 High-performance filtration  (For precision filtration)		
Made-to-Order elements							
Long service life element	X82	Branch type element	X292	PP (Polypropylene) bag element	X72	Filter paper element	X142
P.56 Long service life (Four to five times the filtration area compared with the standard elements)  (For coarse filtration)		P.57 More compact vessel is possible. (Longevity for L440 is same as L770.)  (For coarse filtration)		P.57 Applicable for strong alkali-based cleaning fluid  (For coarse filtration)		P.58 Suitable for filtering cutting fluids  (For coarse filtration)	

Note) Refer to pages 55 to 58 for details on Made-to-Order elements and vessels.

Stable quality and reuse of fluid is possible thanks to filtration!

Contributes to...

Stable product quality
(Fewer defects, etc.)

Prevention of problems in the line
(Prevention of nozzle blockage, etc.)

Less waste fluid

Application example

Washing line

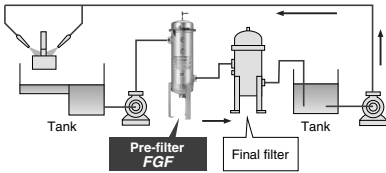

[Filtration of cleaning fluid]

The filter performs filtration of used cleaning fluid so it can be reused many times. (Thanks to cyclical filtration, the volume of waste fluid is reduced.)

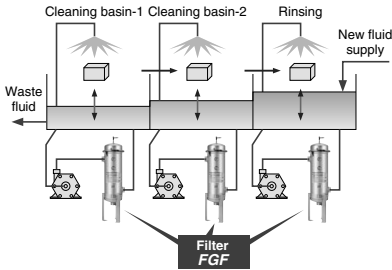

[Filtration of cleaning fluid]

The filter is used to maintain a constant level of cleaning fluid.

Processing line

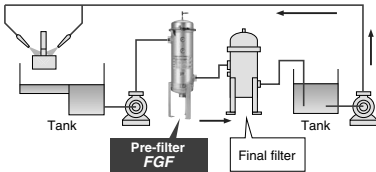

[Filtration of coolant]

The filter performs filtration of used coolant so it can be reused many times.

Filtration of industrial water

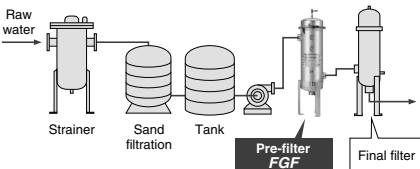

[Filtration of industrial water]

The filter removes foreign matter from raw water so it can be used for manufacturing.

Maintenance example

Two units used side by side

[Reduction in length of time line is stopped for element replacement]

Installing two bag filters means that one filter can always be used while the other is undergoing element replacement, meaning that the line does not have to be stopped for long periods of time for replacement of elements.

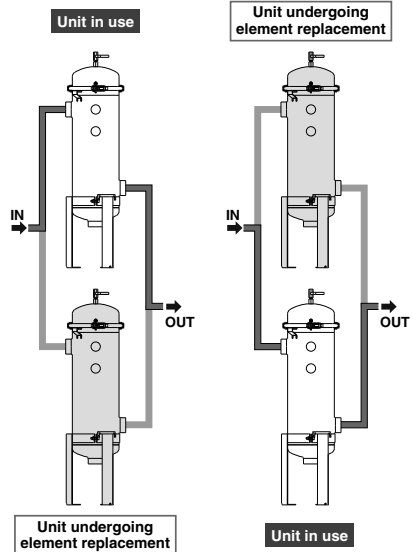

Bag Filter FGF Series

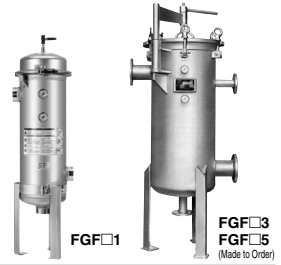

How to Order

One element included

FGF S 1 A - 20 - E 005 B - G □

Three, five elements included (Made to Order)

FGF S 3 A - 40 - E 005 □ - F □

Bag filter

Symbol	Vessel material	Seal material	Applicable model		
			FGF□1	FGF□3	FGF□5
S	Stainless steel	NBR	●	●	●
C	Carbon steel		—	●	●
L	Stainless steel	FKM	●	●	●
R	Carbon steel		—	●	●

Number of elements

Symbol	Number of elements
1	1 pc included (FGF□1)
3	3 pcs included (FGF□3)
5	5 pcs included (FGF□5)

Element size

Symbol	Element size
A	φ190 x L440
B	φ190 x L770

Pressure gauge

Symbol	Pressure gauge
G	With pressure gauge (1 MPa: Brass for wetted parts)
NII	Without pressure gauge (with plug)

* Note that the differential pressure must be controlled strictly.

Option

Symbol	Option*	Applicable model		
		FGF□1	FGF□3	FGF□5
NII	None	●	●	●
F	Companion flange	—	●	●
L	Foundation bolt (3 pcs)	—	●	●

* In the case of multiple options, indicate symbols in alphabetical order.

Nominal filtration accuracy (Note)

Symbol	Nominal filtration accuracy (μm)
005	5
010	10
025	25
050	50
100	100

Part number of element for replacement



EJ 501S - 005

Element size

Symbol	Element size	Applicable model
501S	φ190 x L440	For FGF□□A
601S	φ190 x L770	For FGF□□B

Element material (Polyester)

Symbol	Port size	Applicable model
20	Rc2	FGF□1
40	100(4 ^φ)JIS10 ^{FF}	FGF□3
60	150(6 ^φ)JIS10 ^{FF}	FGF□5

Specifications

Made to Order
(For details, refer to pages 1174 to 1178.)

Model	FGF□1A-20	FGF□1B-20	FGF□3A-40 (Note 7)	FGF□3B-40 (Note 7)	FGF□5A-60 (Note 7)	FGF□5B-60 (Note 7)	
Common	Operating pressure						Max. 0.5 MPa
	Operating temperature						Max. 80°C (For with pressure gauge: 60°C or less)
	Maximum flow rate (Note 1)		Approx. 400 L/min		Approx. 1200 L/min		Approx. 2000 L/min
	Applicable fluid (Note 2)						Water-soluble coolant, Weak alkali-based cleaning fluid, Industrial water (Vessel material: Stainless steel) Oil-based coolant, Cutting oil (Vessel material: Carbon steel)
Vessel (Note 3)	Material	Cover	Stainless steel 304				[FGFS/L] Stainless steel 304 (Note 6) [FGFC/R] Carbon steel
		Case	Stainless steel 304				
		Legs	Carbon steel				
		Seal	NBR or FKM (Note 2)				
	Port size	Rc2		100(4 ^φ)JIS10 ^{FF}		150(6 ^φ)JIS10 ^{FF}	
	Internal volume	23 L	35 L	104 L	156 L	214 L	307 L
	Weight	13 kg	16 kg	170 kg	190 kg	270 kg	315 kg
Accessories	Pressure gauge (Note 4)	1 MPa: Brass for wetted parts					
	Air release valve	1/4 ^φ Ball valve (Brass)					
	Handle for picking elements	Basket integrated		Part No.: AK-1S			
	Davit for cover	None		Yes			
Element	Material	Polyester					
	Nominal filtration accuracy	5, 10, 25, 50, 100 μm					
	Element replacement differential pressure	0.1 MPa (Note 5)					
	Number of elements	1 element included		3 elements included		5 elements included	
	Size	φ190 x L440	φ190 x L770	φ190 x L440	φ190 x L770	φ190 x L440	φ190 x L770
Filteration area	1800 cm ²	3400 cm ²	5400 cm ²	10200 cm ²	9000 cm ²	17000 cm ²	

Note 1) Conditions: Fluid = Water, Pressure drop 7 kPa, Nominal filtration accuracy 100 μm
 Note 2) Confirm the conformity of the fluid to be used.
 Note 3) Surface treatment No. 2D* applies to the external surface of the vessel. (Scratches, scrapes, blotches and uneven color may be present as long as they do not interfere with function or performance.)
 * The symbol refers to surface finishing of JIS G 4305 cold rolled stainless steel sheet.
 Note 4) For the FGF□1 series, this indicates cases where the "with pressure gauge" option has been selected.
 Note 5) Control the element replacement so that the differential pressure does not exceed 0.1 MPa.
 Note 6) Parts other than the wetted parts are made of carbon steel and painted (silver).
 Note 7) Please contact SMC for delivery time as the FGF□3 and FGF□5 are produced upon receipt of order.



FGF Series Model Selection



Selection method

Selection flow chart

Selection example

Step 1 Checking operating conditions

- Fluid • Pressure • Temperature
- Flow rate • Filtration accuracy

Confirm that the specifications are within the appropriate range.

Check the compatibility of fluid with element material [polyester].

To check the compatibility with main fluids, refer to "Selection by Main Application" on page 50.

Check the compatibility of fluid with vessel material [stainless steel 304/ carbon steel].

To check the compatibility with main fluids, refer to "Selection by Main Application" on page 50.

Check the compatibility of fluid with seal material [NBR] or [FKM].

To check the compatibility with main fluids, refer to "Selection by Main Application" on page 50.

Confirm that the temperature is 80°C or less.

Confirm that the pressure is 0.5 MPa or less.

Checking operating conditions

Check fluid/pressure/
temperature/flow rate/
filtration accuracy.

Element material

Consider Made-to-Order products.

Compatibility of fluid
with polyester

Vessel material

Compatibility of fluid
with stainless steel 304/
carbon steel

Seal material

Compatibility of fluid
with NBR or FKM

Temperature

80°C or less

Pressure

Consider special products.

Possible range of pressure specifications up to 1.0 MPa

0.5 MPa or less

OK

«Operating conditions»

- Fluid: Coolant (water-soluble)
[Viscosity equivalent to water:
1 mm²/sec]
- Pressure: 0.3 MPa
- Temperature: 50°C
- Flow rate: 700 L/min
- Filtration accuracy: 50 μm

Confirm that the specifications are within the appropriate range.

- Coolant (water-soluble)
→ Compatibility with polyester: OK
→ Compatibility with stainless steel 304: OK
→ Compatibility with NBR (FKM): OK
- 50°C
→ 80°C or less: OK
- 0.3 MPa
→ 0.5 MPa or less: OK

Selection method

Selection flow chart

Selection example

Step 2 Selecting a vessel

① Calculating the number of elements

Use the flow rate to calculate the number of elements.

Required flow rate ÷ Recommended flow rate = Number of elements

[Recommended flow rate per one element]

400 L/min (Pressure drop 7 kPa to 8 kPa)
 * When viscosity rate is equivalent to water.
 For other viscosities, perform viscosity conversion.

[Number of elements]

Round up: 1.75 elements = 2 elements
 * When flow rate = 50 L/min or less, the compact filters [FGD] [FO] series are recommended.

② Vessel type and number of units

Choose a vessel that satisfies the number of elements obtained in step ①.

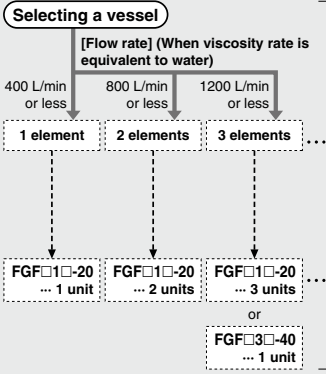

Calculate the number of elements.

Required flow rate ÷ Recommended flow rate

700 L/min ÷ 400 L/min
 = 1.75 = **2 elements**

Choose the vessel type and number of units.

2 elements
 → **FGFS1□-20 ... 2 units**

- FGD
- FGE
- FGG
- FGA
- FGC
- FGF**
- FGH
- FQ1
- FN
- EB□
- ES□

Step 3 Selecting the filter model

① Selecting vessel material and seal material

Select vessel and seal materials from among those compatible with the fluid used.

② Selecting element size

Select the element size when there is a large amount of contamination or frequent replacements.

Flow rate does not change depending on element size.

③ Selecting filtration accuracy

Select the required filtration accuracy depending on conditions.

Filtration accuracy = Nominal filtration accuracy

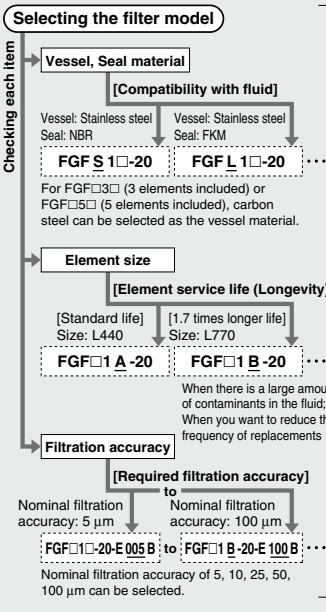

Select vessel and seal materials based on compatibility with the fluid.

Coolant (water-soluble)
 → Stainless steel / NBR: OK
 The model selected is the **FGFS1□-20**.

* In this case, the FGFL1□ with FKM seal material can also be selected.

Select the element size.

With standard life, the model selected is the **FGFS1 A-20**.

* When there is a large volume of contaminants in the fluid or when you want to reduce the frequency of replacements, select the FGFS1B with the L770 size element with 1.7 times longer life.

Select the filtration accuracy.

With a nominal filtration accuracy of 50 μm, the model selected is the **FGFS1A-20-E050 B**.

Step 4 Determining the model and number of units

Determine the filter model and number units based on the results of **Step 2** and **Step 3**.

* Select pressure gauge or other options as needed.

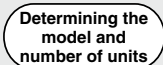

Based on the results of **Step 2** and **Step 3**, **2 units** of the **FGFS1A-20-E050B** are selected.

Selection by Main Application

Field	Fluid	Element		Material		Vessel			
		Material	Filtration accuracy	Vessel	Seal	Compact filter [Other series]	FGF□1	FGF□3	FGF□5
						1 element included	3 elements included	5 elements included	
Machine tools	Coolant (water-soluble)	Polyester	10 to 50 μm	Stainless steel	NBR				
	Coolant (oil-based)			Stainless steel or Carbon steel	NBR				
Washing equipment	Water-based cleaning fluid	Polyester	5 to 25 μm	Stainless steel	NBR		FGFS1□	FGFS3□	FGFS5□
	Weak alkali-based cleaning fluid								
	Alcohol-based cleaning fluid			Stainless steel	FKM				
	Oil-based cleaning fluid						Stainless steel	FKM	
Chlorine- / Fluorine-based cleaning fluid	Polypropylene (See "Made to Order" on P.57.)	10 to 100 μm	Stainless steel	FKM	FGFL1□...X72	FGFL3□...X72			FGFL5□...X72
Strong alkali-based cleaning fluid									
Others	Industrial water	Polyester	10 to 100 μm	Stainless steel	NBR		FGFS1□	FGFS3□	FGFS5□
	Cooling water								

Select the element size □ (A: φ190 x L440; B: φ190 x L770) based on the amount of contaminants.

The above is for guideline purpose only. Check the compatibility of fluid with product, seal and element material before operation.

The flow rate is the appropriate flow rate at a viscosity equivalent to water.

Note 1) Please contact SMC for delivery time as the FGF□3 and FGF□5 are produced upon receipt of order.

Flow Rate Characteristics (Initial Value)

- Test fluid: Water Liquid temperature: 17°C to 20°C (Room temperature)
- Test method: Per SMC test method

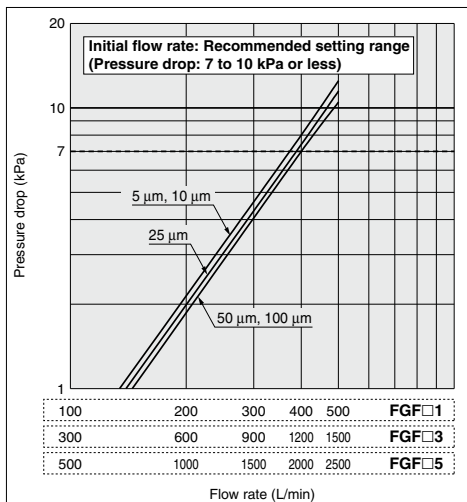

- Flow rate conversion based on viscosity conversion (with viscosity other than that equivalent to water)

Example) Fluid: Coolant (oil-based) Kinematic viscosity: 20 mm²/sec
Flow rate: 285 L/min

1) Calculation of flow coefficient

- Obtain the flow coefficient from the viscosity conversion table.
Kinematic viscosity: 20 mm²/sec → Flow coefficient: 95%

2) Flow rate conversion

- Convert the flow rate when viscosity is equivalent to water using the flow coefficient obtained in step 1).
285 L/min ÷ flow coefficient 95% = 300 L/min
300 L/min flow rate is necessary when viscosity is equivalent to water.

- After this, make a selection using the selection method.
→ When making a selection, designate the flow rate as 300 L/min when viscosity is equivalent to water.

Reference) The recommended flow rate for one coolant (oil-based) element at a kinematic viscosity of 20 mm²/sec is the recommended flow rate when viscosity is equivalent to water (400 L/min) x flow coefficient (95%) = recommended flow rate 380 L/min at a kinematic viscosity of 20 mm²/sec.

Viscosity Conversion Table

Kinematic (mm ² /sec) viscosity (cSt)	400	200	100	50	20	1
	High					Low
Fluid indicator	Equivalent to honey	—	—	Paint	Coolant (oil-based)	Water, Coolant (water-soluble), Cleaning fluid
Flow coefficient (%)	35	58	85	90	95	100

* These relationships between fluids and kinematic viscosity are for guideline purposes only. Check the actual kinematic viscosity of fluid before using. Fluid viscosities shown are at room temperature (17°C to 20°C).

* Flow coefficient: When 100% of water flows at 1 mm²/sec, the flow coefficient indicates that 85% flows at a kinematic viscosity of 100 mm²/sec.

Construction

FGF□1

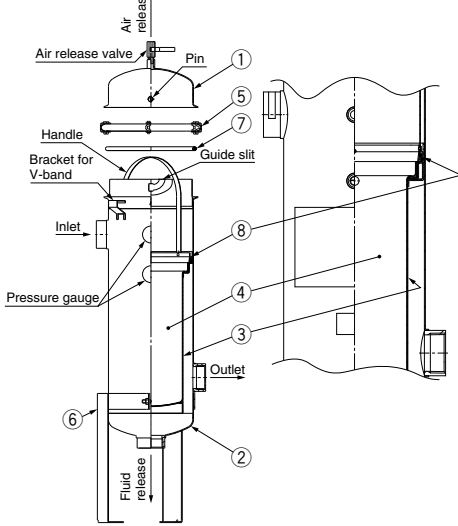

Component Parts/Replacement Parts

No.	Description	Part No.	Material	Qty.	Applicable model ^(Note 1)
1	Cover	—	Stainless steel	1	FGF□1□
2	Case	—	Stainless steel	1	FGF□1□
3	Basket	FGF-BT01	Stainless steel	1	FGF□1A
		FGF-BT02		1	FGF□1B
4	Element	EJ501S-□	Polyester	1	FGF□1A
		EJ601S-□		1	FGF□1B
5	V-band ^(Note 2)	FGF-BA01	Stainless steel	1	FGF□1□
6	Legs (with bolt, nut, flat washer)	FGF-OP01 (Set)	Carbon steel	1	FGF□1□
7	O-ring	FGF-KT01	NBR	1	FGFS1□
		FGF-KT02	FKM	1	FGFL1□
8	Holder (with O-ring)	FGF-KT03 (Set)	Polypropylene/ NBR	1	FGFS1□
		FGF-KT04 (Set)	Polypropylene/ FKM	1	FGFL1□

Note 1) Refer to "How to Order" on page 47 for the □ part of the model number.
 Note 2) When replacing the ⑤ V-band, also replace the ⑦ O-ring at the same time.

FGF□3□-40

FGF□5□-60

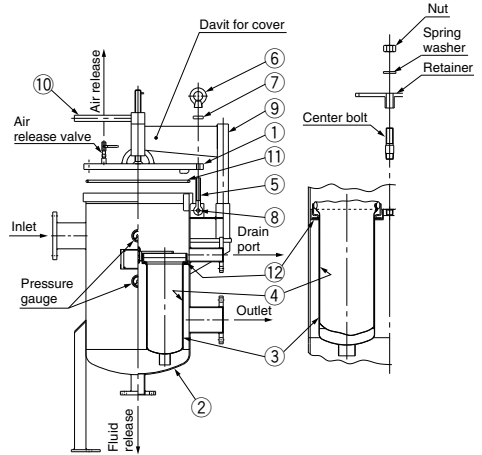

Component Parts and Seal List

No.	Description	Part No.	Material	Qty.	Applicable model ^(Note 1)
1	Cover	—	Stainless steel	1	FGFS/L□□
		—	Carbon steel	1	FGFC/R□□
2	Case ^(Note 2)	—	Stainless steel	1	FGFS/L□□
		—	Carbon steel	1	FGFC/R□□
3	Basket	BT-3S	Stainless steel	3	FGF□3A-40
			Stainless steel	5	FGF□5A-60
		BT-4S	Stainless steel	3	FGF□3B-40
			Stainless steel	5	FGF□5B-60
4	Element	Refer to "How to Order" on page 47.	Polyester	3	FGF□3□-40
			Polyester	5	FGF□5□-60
5	Hinge bolt	—	Carbon steel	—	—
6	Eyebolt	—	Carbon steel	—	—
7	Washer	—	Carbon steel	—	—
8	Parallel pin	—	Carbon steel	—	—
9	Lifter	—	Carbon steel	—	—
10	Handle	—	Carbon steel	—	—
11	O-ring	AL-26S	NBR	1	FGFS3□-40
				1	FGFC3□-40
		AL-27S	NBR	1	FGFS5□-60
				1	FGFC5□-60
AL-23S	FKM	1	FGFL3□-40		
		1	FGFR3□-40		
AL-24S	FKM	1	FGFL5□-60		
		1	FGFR5□-60		
12	Gasket	AL-20S	NBR	3	FGFS3□-40
				3	FGFC3□-40
				5	FGFS5□-60
		AL-21S	FKM	3	FGFL3□-40
				3	FGFR3□-40
				5	FGFL5□-60
5	FGFR5□-60				

Note 1) Refer to "How to Order" on page 47 for the □ part of the model number.
 Note 2) The leg parts are made of carbon steel.

FGD

FGE

FGG

FGA

FGC

FGF

FGH

FQ1

FN

EB□

ES□

FGF Series

Dimensions

FGF□1□-20

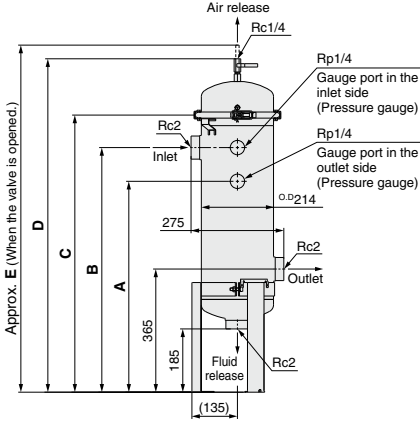
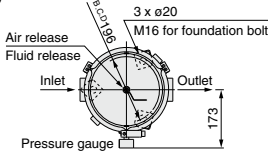

Model	A	B	C	D	E
FGFS1A-20					
FGFL1A-20	625	725	820	985	1025
FGFS1B-20	955	1055	1150	1315	1355
FGFL1B-20					

FGF□3□-40

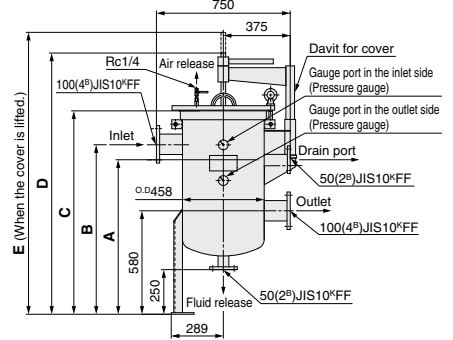
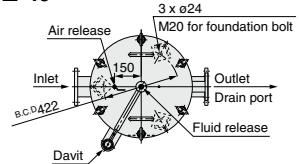

Model	(mm)				
	A	B	C	D	E
FGFS3A-40					
FGFC3A-40	866	950	1140	1464	1580
FGFL3A-40					
FGFR3A-40					
FGFS3B-40					
FGFC3B-40	1196	1280	1470	1794	1910
FGFL3B-40					
FGFR3B-40					

FGF□5□-60

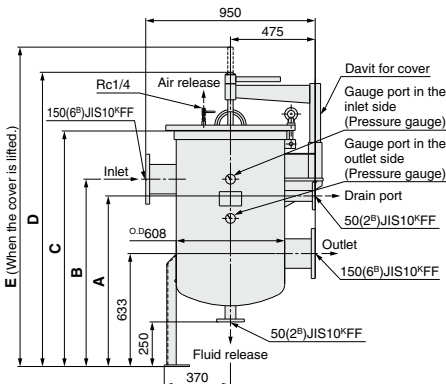
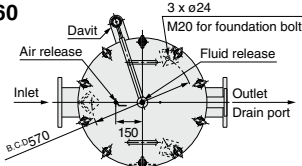

Model	(mm)				
	A	B	C	D	E
FGFS5A-60					
FGFC5A-60	956	1050	1320	1649	1790
FGFL5A-60					
FGFR5A-60					
FGFS5B-60					
FGFC5B-60	1286	1380	1650	1979	2120
FGFL5B-60					
FGFR5B-60					

Options

Companion flange

Flange

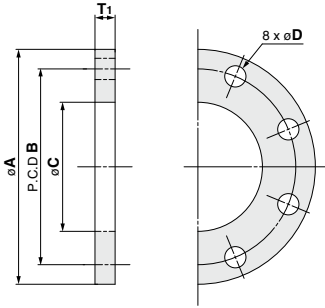

Gasket

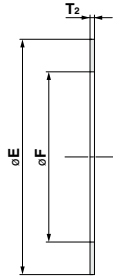

Hexagon bolt and nut

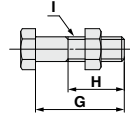

Part No.	Applicable model	Material	G	H	I
AI-17S	FGF□3□-40	Carbon steel	60	38	M16 x 2
AI-18S	FGF□5□-60		70	46	M20 x 2.5

(mm)
Note) 16 pieces are required per filter unit.

Part No.	Applicable model	Flange dimension	Material	A	B	C	D	T ₁
F-86S	FGFC3□-40	10(4 ^B)	Carbon steel	210	175	115.4	19	18
	FGFR3□-40		Stainless steel					
F-87S	FGFS3□-40	150(6 ^B)	Carbon steel	280	240	166.6	23	22
	FGFL3□-40		Stainless steel					
F-88S	FGFC5□-60	150(6 ^B)	Carbon steel	280	240	166.6	23	22
	FGFR5□-60		Stainless steel					
F-89S	FGFS5□-60	150(6 ^B)	Carbon steel	280	240	166.6	23	22
	FGFL5□-60		Stainless steel					

(mm)

Part No.	Applicable model	Material	E	F	T ₂
AL-79S	FGF□3□-40	V ⁶ 6500	159	115	3
AL-80S	FGF□5□-60		220	167	3

(mm)
Note) 2 pieces are required per filter unit.

Set of Components for Companion Flange

Part No.	Applicable model	Flange	Gasket	Hexagon bolt
F-90S	FGFC3□-40	F-86S	AL-79S	AI-17S
	FGFR3□-40	F-87S		
F-91S	FGFS3□-40	F-87S	AL-80S	AI-18S
	FGFL3□-40	F-88S		
F-92S	FGFC5□-60	F-88S	AL-80S	AI-18S
	FGFR5□-60	F-89S		
F-93S	FGFS5□-60	F-89S	AL-80S	AI-18S
	FGFL5□-60	F-89S		

Note) 2 pieces are required per filter unit.
JIS10^{FF} is used for this flange.

Foundation bolt

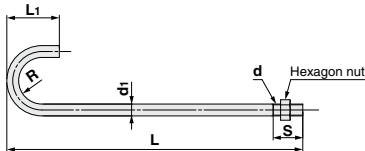

Part No.	Applicable model	Nominal thread size d	d ₁	S	L ₁ (Approx.)	R (Approx.)	L
FGF-OP05	FGF□1□-20	M16	16	40	71	31.5	400
AI-3S	FGF□3□-40	M20	20	50	90	40	500
	FGF□5□-60						

(mm)







Note) 3 foundation bolts are required per filter unit. If ordering only foundation bolts, order 3 bolts using the above part number.

- FGD
- FGE
- FGG
- FGA
- FGC
- FGF
- FGH
- FQ1
- FN
- EB□
- ES□

Made to Order *FGF Series*



Elements

<p>X46 Sub-element + Standard element</p> <p>P.55 Effective for extending the service life of a standard element</p>  <p>(For coarse filtration)</p>	<p>X81 Sub-element</p> <p>P.55 Eliminates large foreign matter.</p>  <p>(For coarse filtration)</p>	<p>X49 HEPO element</p> <p>P.56 High-performance filtration</p>  <p>(For precision filtration)</p>	<p>X82 Long service life element</p> <p>P.56 Long service life (Four to five times the filtration area compared with the standard elements)</p>  <p>(For coarse filtration)</p>
<p>X292 Branch type element</p> <p>P.57 More compact vessel is possible. (Filtration area for L440 is same as L770.)</p> 	<p>X72 PP (Polypropylene) bag element</p> <p>P.57 Applicable for strong alkali-based cleaning fluid</p>  <p>(For coarse filtration)</p>	<p>X142 Filter paper element</p> <p>P.58 Suitable for filtering cutting fluids</p>  <p>(For coarse filtration)</p>	

Leg Material: Stainless Steel





X46 "Sub-element and Standard element" equipped

Coarse filtration

- Effective for extending the service life of a standard element
- Sub-elements eliminate large foreign matter.

(For coarse filtration)

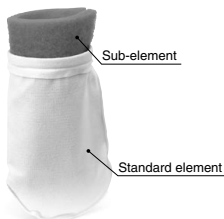

It has a structure such that the spongiiform filtration material, which is made of Polyvinylidene Chlorides, is in the form of a bag. It is then fixed by a ring inside the standard element.

How to Order

RoHS

* Refer to "How to Order" on page 47 for standard specifications.

1 element included FGF * 1 * - 20 - E * B - * * - X46

3/5 elements included (Produced upon receipt of order.) FGF * * * - * - E * * * * * X46

Note 1) Without pressure gauge/Without option: "-" is not required to enter.
Example) FGFS1A-20-E005B-X46, FGFS3B-40-E005X46

Sub-element/Ring Part No. ^{Note 2)}

Element size	Sub-element (single part)	Sub-element with ring	Ring (single part)	Standard element (single part)
L440	EZS340S	EZS320S	FZS310S	EJ501S-□
L770	EZS330S	EZS310S		EJ601S-□

Note 2) When changing from a standard product to one with X46 specifications, order a sub-element with ring. Since the model number will change when replacement is conducted, we ask that the customer manage the model number.

When replacing only the element, order a sub-element (single part) and a standard element and attach the ring before use. Enter the symbol for nominal filtration accuracy in the □ part for the standard element. (Refer to page 47.)

Specifications

Applicable model	FGF□□A	FGF□□B
Main applicable fluid ^{Note 3)}	Coolant (oil-based, water-soluble), Weak alkali-based cleaning fluid, Industrial water	
Nominal filtration accuracy ^{Note 4)}	5, 10, 25, 50, 100 μm (standard element), 500 to 1000 μm (sub-element)	
Operating temperature	Max. 80°C	
Maximum flow rate ^{Note 5)}	Max. 400 L/min	
Element replacement differential pressure	Differential pressure 0.1 MPa	
Filtration material	Polyester (standard element), Vinylidene chloride (sub-element)	
Element size	ø190 x L440	ø190 x L770
Filtration area	1800 cm ²	3400 cm ²

Note 3) Fluids that cause corrosion, deterioration or expansion of the material used in the elements cannot be used.
Note 4) Depends on the filtration accuracy (nominal filtration accuracy) of the element.

Since sub-elements are specialized for coarse filtration, the nominal filtration accuracy is 500 μm or more.
Note 5) Conditions: Fluid = Water, Initial differential pressure 7 kPa, Nominal filtration accuracy 100 μm (standard element)
(For other conditions, refer to "Flow Rate Characteristics" on page 50. Equivalent to standard element)
Maximum flow rate is per one element. When there are three elements or five elements, multiply by 3 or 5.

X81 Sub-element equipped

Coarse filtration

- Eliminates large foreign matter (500 μm or larger).

(For coarse filtration)



Sub-element/Ring Part No. ^{Note 2)}

Element size	Sub-element (single part)	Sub-element with ring	Ring (single part)
L440	EZS340S	EZS320S	FZS310S
L770	EZS330S	EZS310S	

Note 2) When changing from a standard product to one with X81 specifications, order a sub-element with ring. Since the model number will change when replacement is conducted, we ask that the customer manage the model number.
When replacing only the element, order a sub-element (single part) and attach the ring before use.

How to Order

RoHS

* Refer to "How to Order" on page 47 for standard specifications.

1 element included FGF * 1 * - 20 - B - * * - X81

3/5 elements included (Produced upon receipt of order.) FGF * * * - * - * * * * * X81

Note 1) Without pressure gauge/Without option: "-" is not required to enter.
Example) FGFS1A-20-B-X81, FGFS3B-40X81

Specifications

Applicable model	FGF□□A	FGF□□B
Main applicable fluid ^{Note 3)}	Coolant (oil-based, water-soluble), Weak alkali-based cleaning fluid, Industrial water	
Nominal filtration accuracy ^{Note 4)}	500 to 1000 μm	
Operating temperature	Max. 80°C	
Maximum flow rate ^{Note 5)}	Max. 400 L/min	
Element replacement differential pressure	Differential pressure 0.1 MPa	
Filtration material	Vinylidene chloride	
Element size	ø190 x L440	ø190 x L770
Filtration area	1800 cm ²	3400 cm ²

Note 3) Fluids that cause corrosion, deterioration or expansion of the material used in the elements cannot be used.
Note 4) Specialized for coarse filtration, the nominal filtration accuracy is 500 μm or more.

Note 5) Conditions: Fluid = Water, Initial differential pressure 7 kPa
(For other conditions, refer to "Flow Rate Characteristics" on page 50. Equivalent to standard element)
Maximum flow rate is per one element. When there are three elements or five elements, multiply by 3 or 5.

X49 HEPO element equipped

High-performance filtration

- High-performance filtration
- Optimum for filtration of precision machine fluids, precision cleaning fluids, etc.
- Effective for the grinding powders

(For precision filtration)



A cylindrical element in which the filter material made of P.G.P. (Polyester + Glass fiber) is sandwiched by a stainless steel mesh and pleated.

Note 4) Fluids that cause corrosion, deterioration or expansion of the material used in the elements cannot be used.

Note 5) Specialized for precision filtration. The filtration accuracy indicates 98% of filtered particle size.

Note 6) Conditions: Fluid = Water. For other fluids, maximum flow rate changes based on viscosity, etc. Maximum flow rate is per one element. When there are three elements or five elements, multiply by 3 or 5.

How to Order

RoHS

* Refer to "How to Order" on page 47 for standard specifications.

1 element included FGF * 1 * - 20 - Z 003 B - * * - X49

3/5 elements included (Produced upon receipt of order.) FGF * * * - * - Z 003

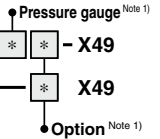

Note 1) Without pressure gauge/Without option: "-" is not required to enter.
Example) FGFS1A-20-Z003B-X49, FGFS3B-40-Z003X49

Element/Element-Fixing Component Part No. ^{Note 2)}

Element size	HEPO element (single part)	Element-fixing component	
		1 included	3/5 included ^{Note 3)}
L440	EZFN20AS	FGF-OP03	FGF-OP013
L770	EZFN30AS		

Note 2) When changing from a standard product to one with X49 specifications, additionally order a HEPO element (single part) and an element-fixing component. Since the model number will change when replacement is conducted, we ask that the customer manage the model number.

When replacing only the element, order a HEPO element (single part).

Note 3) 1 set is required per element.

Ex.) When using 3 elements, order 3 sets.

Specifications

Applicable model	FGF□□A	FGF□□B
Main applicable fluid ^{Note 4)}	Coolant (oil-based, water-soluble), Weak alkali-based cleaning fluid, Industrial water	
Nominal filtration accuracy ^{Note 5)}	3 μm	
Operating temperature	Max. 80°C	
Maximum flow rate ^{Note 6)}	Max. 100 L/min	Max. 200 L/min
Element replacement differential pressure	Differential pressure 0.1 MPa	
Filtration material	Polyester/Glass fiber	
Element size	ø186 x L312	ø186 x L642
Filtration area	16500 cm ²	31600 cm ²

X82 Long service life element equipped

Large filtration area

- Four to five times the filtration area (compared with the standard elements)
- Reduction in number of element replacements

(For coarse filtration)



A cylindrical element in which the non-woven material made of PP (Polypropyldylene) is sandwiched by a PET (Polyester) mesh and pleated.

Note 4) Fluids that cause corrosion, deterioration or expansion of the material used in the elements cannot be used.

Note 5) The filtration accuracy is based on SMC criteria, and differs from the absolute filtration accuracy (filtration efficiency of 97% or more).

Note 6) Conditions: Fluid = Water. For other fluids, maximum flow rate changes based on viscosity, etc. Maximum flow rate is per one element. When there are three elements or five elements, multiply by 3 or 5.

How to Order

RoHS

* Refer to "How to Order" on page 47 for standard specifications.

1 element included FGF * 1 * - 20 - Z 050 B - * * - X82

3/5 elements included (Produced upon receipt of order.) FGF * * * - * - Z 050

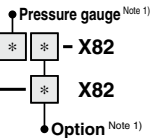

Note 1) Without pressure gauge/Without option: "-" is not required to enter.
Example) FGFS1A-20-Z050B-X82, FGFS3B-40-Z050X82

Element/Element-Fixing Component Part No. ^{Note 2)}

Element size	Long service life element (single part)	Element-fixing component	
		1 included	3/5 included ^{Note 3)}
L440	EZD810AS-050	FGF-OP03	FGF-OP013
L770	EZF730AS-050		

Note 2) When changing from a standard product to one with X82 specifications, additionally order a long service life element (single part) and an element-fixing component. Since the model number will change when replacement is conducted, we ask that the customer manage the model number.

When replacing only the element, order a long service life element (single part).

Note 3) 1 set is required per element.

Ex.) When using 3 elements, order 3 sets.

Specifications

Applicable model	FGF□□A	FGF□□B
Main applicable fluid ^{Note 4)}	Coolant (oil-based, water-soluble), Weak alkali-based cleaning fluid, Industrial water	
Nominal filtration accuracy ^{Note 5)}	50 μm	
Operating temperature	Max. 80°C	
Maximum flow rate ^{Note 6)}	Max. 100L/min	Max. 200L/min
Element replacement differential pressure	Differential pressure 0.1 MPa	
Filtration material	Polypropylene/Polyester	
Element size	ø186 x L312	ø186 x L642
Filtration area	9400 cm ²	12400 cm ²

X292 Branch type element equipped

Large filtration area

- 1.8 times the filtration area (compared with the standard element)
- Filtration area is the same for short size elements (L440) and long size (L770). More compact vessels are possible.

(For coarse filtration)



Two-bag construction made of polyester non-woven material.

How to Order

RoHS

* Refer to "How to Order" on page 47 for standard specifications.

FGF [*] 1 A - 20 - E [*] B - [*] [*] - X292

Note 1) Without pressure gauge/Without option:
 "-" is not required to enter.
 Example) FGF51A-20-E005B-X292

Option ^{Note 1)}
 Pressure gauge ^{Note 1)}

Element Part No. ^{Note 2)}

Element size	Branch type element (single part)	Basket
L440	EJ111S-□ ^{Note 3)}	FGF-BT03

Note 2) When changing from a standard product to one with X292 specifications, additionally order a branch type element (single part) and a basket component. Since the model number will change when replacement is conducted, we ask that the customer manage the model number.

When replacing only the element, order a branch type element (single part).

Note 3) Enter the symbol for nominal filtration accuracy in the □ part. (Refer to page 47.)

Specifications

Applicable model	FGF□□A
Main applicable fluid ^{Note 4)}	Coolant (oil-based, water-soluble), Weak alkali-based cleaning fluid, Industrial water
Nominal filtration accuracy ^{Note 5)}	5, 10, 25, 50, 100 μm
Operating temperature	Max. 80°C
Maximum flow rate ^{Note 6)}	Max. 400 L/min
Element replacement differential pressure	Differential pressure 0.1 MPa
Filtration material	Polyester
Element size	φ190 x L440
Filtration area	3300 cm ²

Note 4) Fluids that cause corrosion, deterioration or expansion of the material used in the elements cannot be used.
 Note 5) Depends on the filtration accuracy (nominal filtration accuracy) of the element.

Note 6) Conditions: Fluid = Water, Initial differential pressure 7 kPa, Nominal filtration accuracy 100 μm (standard element)
 (For other conditions, refer to "Flow Rate Characteristics" on page 50. Equivalent to standard element)
 Maximum flow rate is per one element. When there are three elements or five elements, multiply by 3 or 5.

FGD

FGE

FGG

FGA

FGC

FGF

FGH

FQ1

FN

EB□

ES□

X72 PP (Polypropylene) bag element equipped

Polypropylene

- Polypropylene filter material can be used with a wide variety of fluids.
- Applicable for strong alkali-based cleaning fluid

(For coarse filtration)



How to Order

RoHS

* Refer to "How to Order" on page 47 for standard specifications.

1 element included FGF [*] 1 [*] - 20 - E [*] B - [*] [*] - X72

3/5 elements included (Produced upon receipt of order.) FGF [*] [*] [*] - [*] - E [*] [*] - X72

Note 1) Without pressure gauge/Without option:
 "-" is not required to enter.
 Example) FGF51A-20-E005B-X72, FGF53B-40-E005X72

Pressure gauge ^{Note 1)}
 Option ^{Note 1)}

Nominal filtration accuracy

Symbol	Nominal filtration accuracy (μm)
001	1
003	3
005	5

Element Part No. ^{Note 2)}

Element size	PP (Polypropylene) bag element (single part)
L440	EJ501S-□ X30 ^{Note 3)}
L770	EJ601S-□ X30 ^{Note 3)}

Note 2) When changing from a standard product to one with X72 specifications, order a PP (Polypropylene) bag element. Since the model number will change when replacement is conducted, we ask that the customer manage the model number.

When replacing only the element, order a PP (Polypropylene) bag element (single part).

Note 3) Enter the symbol for nominal filtration accuracy in the □ part.

Specifications

Applicable model	FGF□□A	FGF□□B
Main applicable fluid ^{Note 4)}	Strong alkali-based cleaning fluid, Coolant (oil-based, water-soluble), Weak alkali-based cleaning fluid, Industrial water	
Nominal filtration accuracy ^{Note 5)}	1, 3, 5 μm	
Operating temperature	Max. 80°C	
Maximum flow rate ^{Note 6)}	Max. 400 L/min	
Element replacement differential pressure	Differential pressure 0.1 MPa	
Filtration material	Polypropylene	
Element size	φ190 x L440	φ190 x L770
Filtration area	1800 cm ²	3400 cm ²

Note 4) Fluids that cause corrosion, deterioration or expansion of the material used in the elements cannot be used.
 Note 5) Depends on the filtration accuracy (nominal filtration accuracy) of the element.

Note 6) Conditions: Fluid = Water, Initial differential pressure 8 kPa, Nominal filtration accuracy 5 μm (standard element)
 (For other conditions, refer to "Flow Rate Characteristics" on page 50. Equivalent to standard element)
 Maximum flow rate is per one element. When there are three elements or five elements, multiply by 3 or 5.

FGF Series

X142 Filter paper element equipped

For cutting/grinding oil

- Optimum for filtration of cutting or grinding oil
- Large filtration area makes it suitable for filtering fluids containing highly dense contaminants.

(For coarse filtration)



A cylindrical element with a cotton-made filter inside and a pleated material on the outside for reinforcement.

Note 4) Fluids that cause corrosion, deterioration or expansion of the material used in the elements cannot be used. Only oil-based fluids can be used.

Note 5) Depends on the filtration accuracy (nominal filtration accuracy) of the element.

Note 6) Conditions: When fluid has a kinematic viscosity of 36 mm²/sec (equivalent to turbine oil VG36). For other fluids, maximum flow rate changes based on viscosity, etc. Maximum flow rate is per one element. When there are three elements or five elements, multiply by 3 or 5.

How to Order

RoHS

* Refer to "How to Order" on page 47 for standard specifications.

1 element included FGF * 1 * - 20 - Z 010 B - * * - X142

3/5 elements included (Produced upon receipt of order.) FGF * * * - * - Z 010

● Pressure gauge ^{Note 1)}

● Option ^{Note 1)}

Note 1) Without pressure gauge/Without option: "-" is not required to enter.
Example) FGS1A-20-Z010B-X142, FGS3B-40-Z010X142

Element/Element-Fixing Component Part No. ^{Note 2)}

Element size	Filter paper element (single part)	Element-fixing component	1 included	3/5 included ^{Note 3)}
L440	EJ501S-010X6	FGF-OP03		FGF-OP013
L770	EJ601S-010X6			

Note 2) When changing from a standard product to one with X142 specifications, additionally order a filter paper element (single part) and an element-fixing component. Since the model number will change when replacement is conducted, we ask that the customer manage the model number.

When replacing only the element, order a filter paper element (single part).

Note 3) 1 set is required per element.

Ex.) When using 3 elements, order 3 sets.

Specifications

Applicable model	FGF□□A	FGF□□B
Main applicable fluid ^{Note 4)}	Coolant (oil-based), Lubricating oil	
Nominal filtration accuracy ^{Note 5)}	10 μm	
Operating temperature	Max. 80°C	
Maximum flow rate ^{Note 6)}	Max. 100 L/min	Max. 200 L/min
Element replacement differential pressure	Differential pressure 0.1 MPa	
Filtration material	Cotton	
Element size	φ186 x L312	φ186 x L642
Filtration area	8900 cm ²	18500 cm ²

X47 Leg material: Stainless steel

- Legs made of stainless steel can be used.



Legs (Material: Stainless steel)

Legs Part No.

Part no. ^{Note 2)}	Material	Included parts
FGF-OP02	Stainless steel	Mounting bolt/Nut/Flat washer

Note 2) When changing from a standard product to one with X47 specifications, order the part numbers above and replace only the legs. Since the model number will change when replacement is conducted, we ask that the customer manage the model number.

How to Order

RoHS

* Refer to "How to Order" on page 47 for standard specifications.

FGF * 1 A - 20 - E * B - * * - X47

● Option ^{Note 1)}

● Pressure gauge ^{Note 1)}

Note 1) Without pressure gauge/Without option: "-" is not required to enter.

Example) FGS1A-20-E005B-X47

Specifications

Applicable model	FGF□1A	FGF□1B	
Common	Operating pressure	Max. 0.5 MPa	
	Operating temperature	Max. 80°C	
	Maximum flow rate ^{Note 3)}	Max. 400 L/min	
	Main applicable fluid ^{Note 4)}	Coolant (oil-based, water-soluble), Weak alkali-based cleaning fluid, Industrial water	
Vessel	Cover	Stainless steel 304	
	Material	Stainless steel 304	
	Case	Stainless steel 304	
	Legs	Stainless steel 304	
Element	Port size	Rc2	
	Internal volume	23 L	35 L
	Weight	13 kg	16 kg
	Filtration material	Polyester	
	Nominal filtration accuracy ^{Note 5)}	5, 10, 25, 50, 100 μm	
	Element replacement differential pressure	Differential pressure 0.1 MPa	
Element	Number of elements	1	
	Element size	φ190 x L440	φ190 x L770
	Filtration area	1800 cm ²	3400 cm ²

Note 3) Conditions: Fluid = Water, Initial differential pressure 7 kPa, Nominal filtration accuracy 100 μm (standard element) (For other conditions, refer to "Flow Rate Characteristics" on page 50. Equivalent to standard product.)

Note 4) Fluids that cause corrosion, deterioration or expansion of the material used in this filter and elements cannot be used.

Note 5) Depends on the filtration accuracy (nominal filtration accuracy) of the element.



FGF Series Specific Product Precautions

Be sure to read this before handling the products.

Refer to back page 50 for Safety Instructions and the Operation Manual for details.

Please download the Operation Manual via SMC website, <http://www.smcworld.com>

Model Selection/Design

Do not select a model exceeding specification ranges and carefully consider the purpose of use, required specifications and operating conditions such as fluid, pressure, flow rate, temperature and environment. Mishandling may lead to an unexpected accident.

Warning

1. Operating pressure

Do not use the product beyond the operating pressure range. Do not use in locations where peak pressure exceeds the operating pressure due to water hammer, surge pressure, etc.

2. Operating temperature

Do not use the product beyond the operating temperature range. Do not use at temperatures at or above the boiling point of the fluid.

3. Fluid

- Use the product for filtering coolant (oil-based or water-soluble), weak alkali-based cleaning fluid or industrial water.
- Never use the product with **gases**.
- Do not use the product with corrosive fluids.
- Do not use the product with fluids which will likely cause the expansion and deterioration of seals, O-rings or the element. Some fluids can deteriorate a seal or an O-ring, and have an affect on the filter function, causing leakage.
- The wetted parts of the pressure gauge is made of brass. Check the compatibility with fluid in use.

4. Operating environment

- Do not use in operating conditions or environments where changes in color or deterioration of material due to corrosion occur.
- Do not use this product in a place where shock or vibrations occur.

Caution

1. Pressure drop (ΔP)

- Use the product with a flow which has an initial pressure drop which will become 10 kPa or less.
- The pressure drop fluctuates depending on operating conditions. Since the pressure drop is one of the factors indicating filter characteristics, use the filter by setting a controlling standard.

2. Installation space

Arrange the necessary space for inspection, before installing and piping the product.

[Maintenance work space]

- Above vessel (for removal of basket during element replacement) ... At least 450 mm of space above vessel
- Around band (for removal of band during element replacement) ... At least 50 mm of space around band

* Applies to FGF□□1□

Installation and Piping

Caution

1. Use the product with a circuit having lesser fluctuation to the filter caused by pressure or flow. (Refer to Fig. 1.)

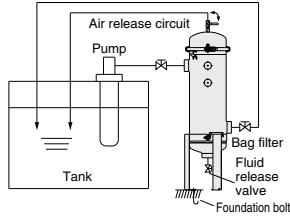

Fig. 1 Example of cyclical filtration circuit

2. Use the product in a circuit where no backflow occurs in the filter. If any backflow occurs, take appropriate measures, such as installation of a non-return valve. The riser piping at the outlet of the filter may also cause backflow. So, take appropriate measures shown above.
3. Firmly fix the bottom to the ground using foundation bolts, etc.
4. Connect the valves or fittings suited to the operating conditions by checking the size of each connection port. During connection work, make sure that powder from the piping screws or seal material does not get into the interior of the piping. Prior to operating, flush the piping line and check for abnormalities, such as fluid leakage.
5. Firmly fix the piping to the mounting frame using a saddle, etc., to avoid vibration or force caused by the weight.
6. During element replacement, it is necessary to release fluid from the vessel. Be sure to connect the pipe to the fluid release port so that fluid releasing work can be absolutely performed.
7. Pipe so that air releasing work can be absolutely performed.

The air releasing work can be done firmly if you make the piping in order to flow a small flow constantly into a tank by resin tubing, etc. from the air release valve. (Refer to Fig. 2.)

However, because the pump is in a high position, idling sometimes occurs during re-start. Take measures such as releasing the air in a high position, etc.

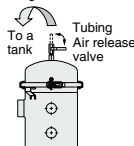

Fig. 2 Air release circuit

Operation

Warning

1. Never loosen the V-band under pressurized conditions.

Operation

Caution

1. Releasing the air

When applying pressure for starting a pump, etc., be sure to release the air by opening the air release valve on the top. (Refer to Fig. 3.)

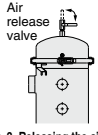

Fig. 3 Releasing the air

2. When operating

When applying pressure for starting a pump, etc., confirm that each connecting parts are completely sealed. If any abnormality is found, such as fluid leakage, stop the product immediately and locate the possible cause of the failure. Resume operation after taking appropriate measures to stop the fluid leakage by replacing the O-rings or additionally tightening the fittings, etc.

Maintenance

Warning

1. Failure to observe the procedure will likely cause fluid leakage or removal of a cover, which may lead to an unexpected accident. (Follow the procedure in the operation manual.)
2. Confirm that the line has stopped and pressure has been reduced to zero before performing maintenance work.

Caution

1. Timing of element replacement

When the time has come to replace the element, replace it with a new element immediately.

= Timing of element replacement =

- When pressure drop has reached to 0.1 MPa.

2. Element replacement work

• Carry out element replacement work based on the procedure in the operation manual. Mishandling could lead to malfunction or damage the machinery and equipment.

• Replace the elements only after confirming that the pressure is zero.

• The parts used for tightening the cover (V-band, etc.) must be properly positioned after replacing elements.

3. Cleaning each component

During element replacement, in order for firm sealing to take place, clean the sealing surface of the seal and/or remove the paint which is left on the tightened parts of the cover or the thread parts.

4. Replacing seals

Replace the deteriorated or expanded O-ring, gasket holder assembly or other seals.

Also, replace the seal after it has been used for one year or when fluid leakage occurs.

5. Parts used for tightening the cover

If a part used for tightening the cover (V-band, etc.) is deformed or the threads are galled, it must be replaced.

6. Temperature

When operating at high temperatures (40°C to 80°C), there is danger of burns, etc.

Confirm that the surface temperature of the filter or the parts for operation (V-band, element, etc.) are 40°C or less, to prevent a burn from occurring.

FGD

FGE

FGG

FGA

FGC

FGF

FGH

FQ1

FN

EB□

ES□