





Single side pushbutton 56 Universal

Equipment consisting of (schematic overview)

-  Front bezel Page 39
-  Screws
-  Lens
-  Switching unit

Each Part Number listed below includes all the black components shown in the 3D-drawing.

To obtain a complete unit, please select the red components from the pages shown.

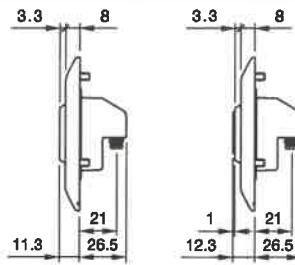

Dimensions [mm]



The preview is based on a sample product. This can differ from your current configuration.

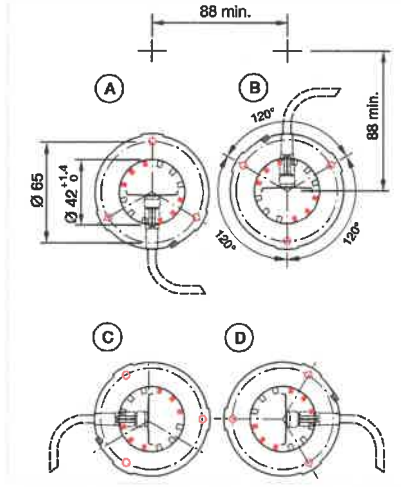

Mounting cut-outs [mm]
 A = Cable exit bottom
 B = Cable exit top
 C = Cable exit left
 D = Cable exit right

Additional information

















- Laser engraving on lens possible
- 14 standard symbols
- ISO 7000 symbols on request
- Other symbols available on request (minimum order quantity 50 pcs.)
- Standard device plug M8x1, 6-pole
- User-friendly, large Ø 33 mm actuating surface
- Highly visible LED illumination green/red
- Operating voltage 10–30VDC
- Scope of delivery without cable
- Please fill in the form and forward it to your local EAO partner by e-mail or fax. The electronic form is available at www.eao.com/downloads



Switching unit, without lens, without front bezel

Housing colour	Housing material	Part No.	Wiring diagram	Component layout
<input type="checkbox"/> Black	Plastic	56-1520.0000	441	106

56 Front mounting

Lens aluminium		Artikel-No.					
<input type="checkbox"/> without symbol		56-4.00001					
<input type="checkbox"/> with symbol, black, laser engraved							
	<input type="checkbox"/> Part No. 56-6.00001	<input type="checkbox"/> Part No. 56-6.00002	<input type="checkbox"/> Part No. 56-6.00003	<input type="checkbox"/> Part No. 56-6.00004	<input type="checkbox"/> Part No. 56-6.00005	<input type="checkbox"/> Part No. 56-6.00006	
							
	<input type="checkbox"/> Part No. 56-6.00007	<input type="checkbox"/> Part No. 56-6.00008	<input type="checkbox"/> Part No. 56-6.00009	<input type="checkbox"/> Part No. 56-6.00010	<input type="checkbox"/> Part No. 56-6.00011	<input type="checkbox"/> Part No. 56-6.00012	
<input type="checkbox"/> with symbol plastic, black raised							
	<input type="checkbox"/> Part No. 56-6.00013	<input type="checkbox"/> Part No. 56-6.00014					
							
	<input type="checkbox"/> Part No. 56-1.00001	<input type="checkbox"/> Part No. 56-2.00001	<input type="checkbox"/> Part No. 56-3.00001				

Wiring diagrams

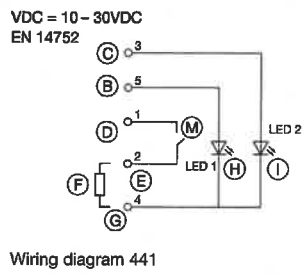

Legend

- B = VDC illumination green
- C = VDC illumination red
- D = VDC
- E = Switch (not potential-free)
- F = Load (max. 250mA)
- G = 0 V
- H = Illumination green
- I = Illumination red
- M = High Side Switch

Component layouts

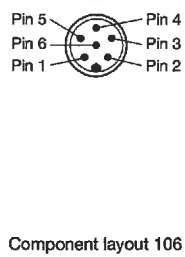

Pin Assignment
Front View
M8 male A-Coding 6 Pin
according to EN 61076-2-104

56 Technical data

Pushbutton 56 Universal

Single side pushbutton with M8×1 connector, 6-pin

Switching system

The Series 56 Universal pushbutton is equipped with an electronic high side switch, is short circuit proof and overload protected. In case of over current the switch opens automatically (protection against destruction). The pushbutton is not potential-free.

Material

Lens

Aluminium, Symbol Plastic

Front bezel

Plastic

Switch housing

Plastic

Mechanical characteristics

Terminals

Device plug M8×1, 6-pin (according to EN 61076-2-104)
For locking the cable plug connection, the thread ring "hand-tight" (approx. 0.5Nm) tightened.
Suitable for screw locking (cable side),
Snap-in locking (cable side) with reduced IP protection class.

Cable recommendation

6-pole with coupling socket M8×1 straight
(according to EN 61076-2-104)

Fixing screws

Single side pushbutton for front mounting M4 × 8 mm

Tightening torque

Screws for one-sided button for front mounting 0.8...1 Nm

Key (mounting and dismantling)

Inside 6-kt Width across flats 2.5 mm

Actuating force

max. 15N

Actuating travel

~0.5mm

Mechanical life

>5 million switching cycles

Electrical characteristics

Illumination

Standby, 6 lighting points green

6 lighting points red

Optical switching indicator (wiring diagram according to EN 14752)

Operating voltage 24 VDC

Tolerance range -30 % ... +25 %

Current consumption <50 mA

Luminosity and wave length variations caused by LED manufacturing processes may cause slight differences regarding the illumination.

Devices correspond

EN 50155

EN 14752

EN 45545

EN 61373

EMV

EN 61000-6-2

EN 61000-6-3

EN 50121-3-2

ESD according to EN 61000-4-2 ±20 kV

Regulation No. EMV 06 (radio compatibility of Deutsche Bahn)

Operating voltage

10-30VDC

Switching current

max. 250 mA

min. 10 µA

Quiescent current

<10 µA @24 VDC

Note: Only pin 1 (VDC) and pin 4 (0 V) connected

Electric strength

4000 VAC, 50 Hz, 1 minute, between all terminals and mounting plate / front element

Ambient conditions

Storage temperature

-45 °C ... +90 °C

Operating temperature

-45 °C ... +85 °C

Protection degree

IP66, IP67 front side

IP65 rear side with device plug M8×1 straight, 6-pin with snap-in locking (cable side)

IP67 rear side with device plug M8×1 straight, 6-pin with screw locking (cable side)

Impact resistance

IK07

Climate resistance

Damp heat, cyclic

48 hours, +25 °C/97 %, +55 °C/93 % relative humidity, according to EN IEC 60068-2-30

Damp heat, state

56 days, +40 °C/93 % relative humidity, according to EN IEC 60068-2-78

Rapid change of temperature

5 cycles, -45 °C...+90 °C, according to EN IEC 60068-2-14

Shock resistance

Semi-sinusoidal

500 m/s², pulse width 11 ms, 6 shocks/axis, according to DIN EN 60068-2-27

Vibration strength

(sinusoidal)

max. 100 m/s² from 10 Hz ... 500 Hz, according to EN IEC 60068-2-6

Broad band noise according to EN 61373 class 1B

7.9 m/s² 5 h per axis, according to EN IEC 60068-2-6

Approvals**Conformities**

CE

2014/30/EU (EMC)

2011/65/EU (RoHS)