

S0109 Single Switch Solution

Revision C



All Rights Reserved Worldwide

NKK Switches makes no warranty for the use of these products and assumes no responsibility for any errors, which may appear in this document, nor does it make a commitment to update the information contained herein.
SmartDisplay is trademark of NKK Switches.

Table of Contents

1. Overview	3
2. Applications	3
3. How to Order	4
S0109 Single Switch Solution	
1. S0109 General Features	5
2. Backlighting	6
3. Hardware	7
4. Connecting to Application	9
IS-S0109DEM Evaluation Kit User Manual	
1. General Features	10
2. Preface	10
3. Operational Overview	10
4. UART communication	12
5. Hardware	16
6. Schematics	18
Programming S0109 Single Switch Solution	
1. Preparing the IS-S0109Dem for Programming	19
2. Preparing the MPLAB Program	19
3. Programming the S0109	21
4. Testing	23
Warranty	24

1. Overview

The **Single Switch Solution** is a compact device that can both monitor and control an industrial process independently or in conjunction with other controllers.

The 36x24 pixel LCD display is capable of displaying graphics or characters while the 64 backlight color options allow for status color schemes and modes of operation. In addition to the on-board flash, capable of holding up to 64 graphic images, there are two look-up fonts (5x7 and 7x10) on board to create images based on characters. Up to 3 lines of 6 characters in font 5x7 or up to 2 lines of 4 characters in font 7x10 can be displayed.

There are twelve connections that can be digital input/output or Analog input. The analog inputs can be used to check status of gauges such as temperature, pressure, voltage, amperage, oil level, gas level...etc.

The digital inputs can be used to check the ON/OFF statuses of a devices or count frequency of an event.

The digital output can be used to signal to turn ON or OFF a device based on preset values of the inputs.

The digital input/output can also be used for communication with another device. There can be one PWM output.

The switch presses can be used for toggling between the statuses and pressing and holding the switch can be used for setting up or selecting an option.

SPI, I2C or UART communications are possible.

EMC/ESD compliance based on the IEC 60601-11-2:2014.

2. Applications

The Single Switch Solution is a plug and play controller/indicator device for use in an application with little to no technical or engineering know-how needed to install and operate.

The customer would list what images, labels and actions they want to see. The device would then be programmed and preloaded with the images, actions and responses ready to be used. The customer would simply need to install the device into their application. Please contact NKK Switches with your application. If the current product does not meet your application, we can design a device to meet your requirements.

Examples:

- A Single Switch Solution is hooked up to a device that drops jellybeans into a bag and a counting sensor. When the Single Switch Solution counts out a fixed number of beans it sends signals to stop the jellybeans from dropping, move the bag out of the way, seal the bag and get the next bag.
- A Single Switch Solution is used to monitor two voltages and two currents. Pressing the switch steps through displaying the status of each of the four measurements. When the voltages or currents exceed a preset warning range the display blinks to warn the operator. When the voltages or currents reach a danger range not only does the display turn red it also sends signals to shut down the system. The warning and shut down values for each measurement is user defined and can be modified by pressing and holding the switch while displaying the measurement.
- A Single Switch Solution is hooked up to engine sensors to display fuel, water, oil, and temperature. Pressing the switch steps through and displays the four statuses. When any of the statuses are outside normal the display blinks amber to warn the operator. When any of the statuses are in the danger range the display blinks red.

3. How to Order

Single Switch Solution is custom programmed for each application, so a custom part number is assigned for each application.

An evaluation kit can be ordered to get the process started. The evaluation kit part number is “**IS-S0109DEM**” and includes:

1. One Single Switch Solution.
2. A demonstration board that has the following features:
 - A. 4 potentiometers for analog input,
 - B. 4 switches for digital input and
 - C. 4 LED's for indicate status of each digital I/O.
 - D. The demonstration has UART to USB converter for communication.
 - E. Connector for 2 pins for possible I2C firmware testing
3. A programming connector for reprogramming the Single Switch Solution (Require a Pickit3 from Microchip for programming).
4. A USB connection for power and communication.

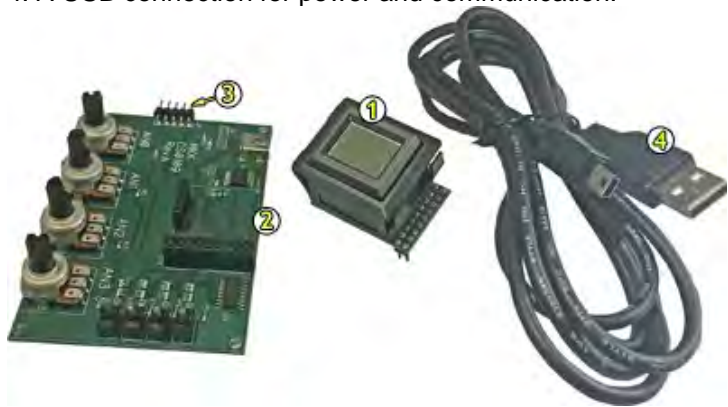

The evaluation kit **IS-S0109DEM** comes preprogrammed for demonstrating the Single Switch Solution capabilities.

The suggested retail price for evaluation kit is USD\$99.00 F.O.B Arizona.

The information on the evaluation kit is at the end of this document.

Once the customer decides on the features required for their application the requirements are evaluated by NKK and functional features are documented. Then they are sent for customer approval. Once approved the firmware is written, and the custom part number is issued. The customer can place the order and receive the preprogrammed Single Switch Solution for their application. The cost of writing the firmware is **USD\$300.00**.

During firmware development the customer is required to get a PIC programmer PICKit 3 (cost about \$49.00). The firmware is emailed to the customer. The evaluation kit IS-S0109DEM can be used to reprogram the Single Switch Solution as well as for testing and verification of the new firmware.

S0109 Single Switch Solution

Firmware 2.0

1.S0109 General Features

The Single Switch System is useful in many applications where complex information needs to be displayed while minimizing design and installation time and complexity. The firmware is written based on customer requirements. **Contact Hassan Sajadi at 480-505-3762 or engineering@nkkswitches.com for application consultation.**

Features:

- 36x24 pixel graphic LCD.
- Can display 3 lines of 6 characters in Font 5x7, 2 lines of 4 characters in Font 7x10 or graphic.
- 64 backlight colors (RGB) for various mode of operation.
- 8 level of backlight brightness
- Panel Mount for easy installation.
- Single pole momentary switch.
- Firmware is written based on customer requirements.
- The connection to application is via 2x9 header (0.1"x0.1").
- Up to 12 digital input/outputs or Analog to digital converter
- One PWM
- I2C, SPI, or UART configurations are available upon request.
- A customer has got EMC/ESD compliance based on the IEC 60601-11-2:2014
- Many interface boards are available for converting Analog/digital input to proper voltage and convert the digital I/O to proper voltage/current to sense, turn OFF and ON devices. Please contact factory with your requirement.

S0109 photos



Part Number Attributes: IS-S0109XXX. Each application would have a unique part number.

IS-S0109	XXX
Base part number	Unique for each application

2. Backlighting

There are two backlighting states: "ON cycle" and "OFF cycle". The duration time of OFF cycle is about 500 mS. The ON cycle is two times of duration of the OFF cycle. Both the duration of the OFF cycle and the multiple of the ON cycle to the OFF cycle can be specified by the customer. Each of the ON cycle and OFF cycle have 8 color option. The 64 backlight options are achieved by combination of ON cycle and OFF cycle. Additionally, 8 level of brightness are available. Below are the options for ON and OFF cycle:

Available color for ON cycle and OFF cycle				
	Color	Red	Green	Blue
1	OFF	OFF	OFF	OFF
2	Red	ON	OFF	OFF
3	Green	OFF	ON	OFF
4	Blue	OFF	OFF	ON
5	Amber	ON	ON	OFF
6	Light Blue	OFF	ON	ON
7	Magenta	ON	OFF	ON
8	White	ON	ON	ON

The LED code is one byte. Bit=1 is for ON

Bits	B7	B6	B5	B4	B3	B2	B1	B0
Cycle	Must be zero	OFF Cycle	OFF Cycle	OFF Cycle	Must be zero	ON Cycle	ON Cycle	ON Cycle
Color	0	Blue	Green	RED	0	Blue	Green	RED

3. Hardware

WARNING: These products are ESD sensitive. The ESD handling procedures must be followed.

The Single Switch System incorporates an IS15BBFP4RGB in a Panel Mount Housing soldered to a small controller PCB.

Power input: 5V or 7.5V to 15V at maximum of 35 mA

Dimensions:

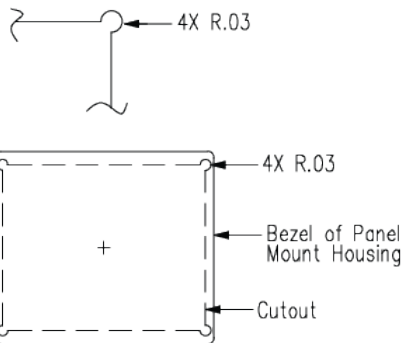
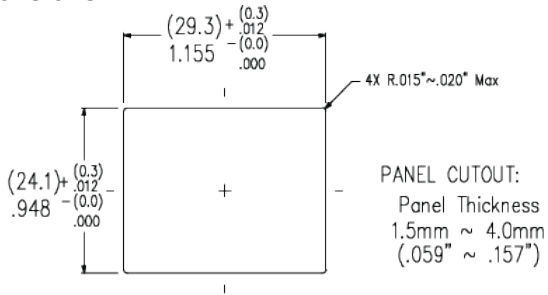

In place of creating a small radius inside the cutout, the radii can extend beyond the cutout and the Bezel would still cover them.

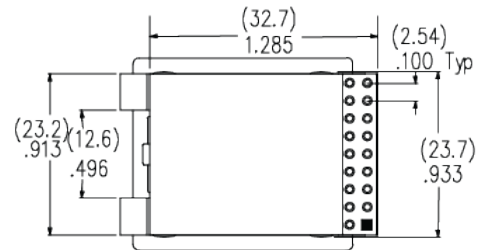
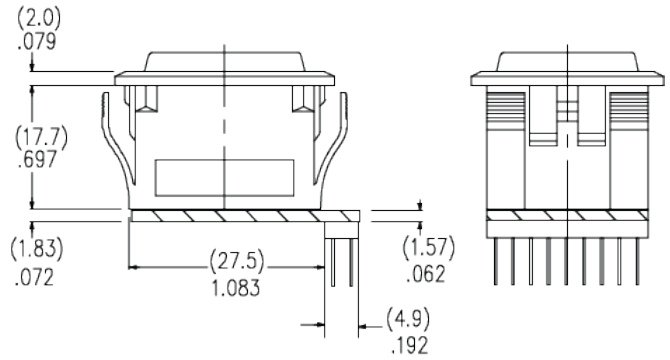
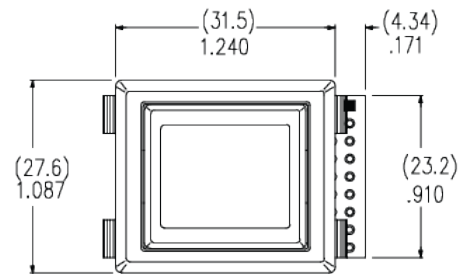

Application Interface Header (J1) is a 9x2 header .1" x .1" for application connections.

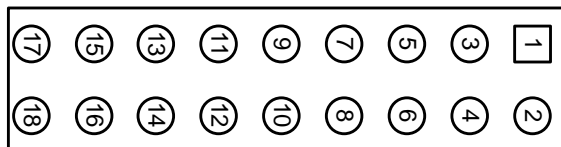

Application Interface Header (J1) pinout			
Pin#	Pin Name	Possible Function	Notes
1	RC2	Digital/Analog	Used as UART TX in demo unit. Do not use unless you need more than 10 I/O.
2	RC1	Digital/Analog	Used as UART RX in demo unit. Do not use unless you need more than 10 I/O.
3	RC4	Digital/Analog	Can be used as I2C SDA
4	RC3	Digital/Analog	Can be used as I2C SCL
5	Power	Input voltage 7.5V to 15V	If pin 9 is used as 5V power in, this pin should be connected to 5V as well
6	Power	Input voltage 7.5V to 15V	If pin 9 is used as 5V power in, this pin should be connected to 5V as well
7	Ground	Ground	
8	Ground	Ground	
9	5V	5V output.	If pins 5/6 are used as power in, the 5V is generated by the onboard voltage regulator. The maximum current drawn cannot exceed 10 mA.
10	DG0	Digital/Analog	
11	DG1	Digital/Analog	
12	AN1	Digital/Analog	
13	AN0	Digital/Analog	Can be used as I2C SCL
14	SWRD	Switch output	Switch pin connected to MC pin with a weak pull-up. The other switch pin is connected to Ground. In the RevC a diode is placed between MC pin and the switch pin to protect the MC from external switch scan.
15	DG2	Digital/Analog	Can be used as I2C SDA
16	DG3	Digital/Analog	
17	AN3	Digital/Analog	
18	AN2	Digital/Analog	

Note: Any of I/O pins can be used as SPI

4. Connecting to Application

All the I/O pins are directly connected to the microcontroller pin. There is no safety circuit due to lack of space. If the application signals are not stable appropriate safety measures should be implemented in the application or interface board.

Analog Resolution: 10 bits

Analog Voltage: 0 to 5V

Digital input Voltage: $V_{il} < 0.8V$, $2V < V_{ih} < 5V$

Digital output Voltage: $V_{ol} < 0.6V$, $4.2V < V_{oh}$

Maximum output current sourced: One I/O pin 20 mA, Total for all I/O pins 50 mA

Maximum current sunk: One I/O pin 20 mA, Total for all I/O pins 100 mA

Some applications require an interface board for converting the Analog input to proper voltage or turning on relays that require more current. NKK has interface boards for some application. We also entertain designing interface boards for new applications.

IS-S0109DEM Evaluation Kit User Manual

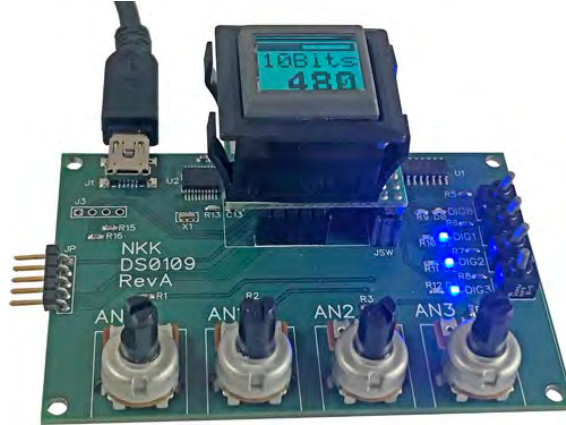

1. General Features

The IS-S0109DEM is a demonstration unit for the Single Switch Solution. Below are the current features:

- Four potentiometers wired to four pins to simulate various Analog input signals.
- Four toggle switches and four LED's wired to Digital In/Out to simulate digital in and digital out.
- USB connection for power and communication.
- Programming plug.



2. Preface

The IS-S0109DEM is designed to demonstrate the features of the Single Switch Solution. It has four potentiometers, four toggles, and four LED's that simulate various inputs and outputs. It has been programmed to show some of the different ways to use the Single Switch Solution. However, the firmware can be altered by NKK Switches as per customer requirements. This manual will go through the various aspects of the firmware written for demonstration of features. The UART to USB adapter on the demo unit allow communication to computer. The firmware is being written to allow varicose communication commands. The commands will be listed on the next revision.

3. Operational Overview

When first turned on the IS-S0109DEM will display the NKK Switches logo. After 2 seconds it will then display the battery charge image. Pressing the button steps through each of the six simulated functions. It then loops back to the beginning.

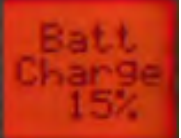
Pinout used in IS-S0109DEM			
Pin#	Pin Name	Possible Function	IS-S0109DEM
1	RC2	Digital/Analog	UART TX
2	RC1	Digital/Analog	UART RX
3	RC4	Digital/Analog	Input with weak pull up
4	RC3	Digital/Analog	PWM out
5	Power	Input voltage 7.5V to 15V	5V power in
6	Power	Input voltage 7.5V to 15V	5V power in
7	Ground	Ground	Ground
8	Ground	Ground	Ground
9	5V	5V output.	5V power in
10	DG0	Digital/Analog	Turn LED0 on when battery is in amber color
11	DG1	Digital/Analog	Turn LED1 on when battery is in red color
12	AN1	Digital/Analog	Analog in. Demonstrate 10 bits analog converter
13	AN0	Digital/Analog	Analog in. Battery Analog in
14	SWRD	Switch output	Switch pin connected to MC pin with a weak pull-up. The other switch pin is connected to Ground. In the RevC a diode is placed between MC pin and the switch pin to protect the MC from external switch scan.
15	DG2	Digital/Analog	Used to start and stop timer
16	DG3	Digital/Analog	Used as counter
17	AN3	Digital/Analog	Analog in. Voltmeter
18	AN2	Digital/Analog	Analog in. Rotary 16 levels

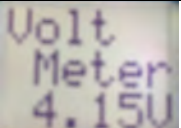
Image	Function	Operation
	NKK Logo Splash Screen	Only seen when first turned on. Stays on only for a few seconds.
	Battery Charge *	AN0 input is represented/displayed from 0% to 100% with green backlight. ---The warning level at which point in addition to the amber/Green backlight blink a signal is sent to DIG0 to turn ON the LED. --- The Danger level at which point in addition to the red backlight blink a signal is sent to DIG1 to turn ON the LED.
	10 Bits Stepper	AN1 input is represented/displayed from 0 to 1023 steps indicating the 10 bits analog resolution.
	0-5 Voltmeter	AN2 input is represented/displayed from 0 to 5.00V.

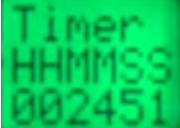
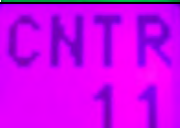
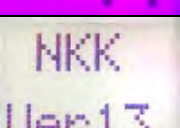
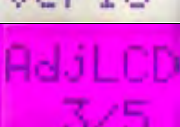
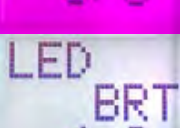
	Rotary Stepper	AN3 input is represented/displayed in 16 steps 1/16 to 16/16.
	Timer	Turns on and off by Dig 2 toggle control. Green when running and amber when stopped.
	Counter	Counts each time the Dig 3 toggle is actuated. Resets to zero when power is off.
	Firmware Version	The current firmware loaded on the S0109. Hold down pushbuttons to go to brightness controls.
	LCD Brightness Adjustment	Brightness control: Adjusts the contrast (or how dark the pixels are) of the LCD. Levels 1-5. After 5 seconds of inactivity it jumps to LED Brightness Adjustment.
	LED Brightness Adjustment	Brightness control: Adjusts the brightness of the backlight LEDs. Levels 1-5. After 5 seconds of inactivity it jumps to Firmware Version.

* To select warning and danger level press and hold the switch while it is displaying “Batt Charge” till the display shows “Amber”. Then release the switch followed by press/releases to get to the desire choice (None, 5% to 90%). After 5 seconds of inactivity the danger setting appears when the display shows “RED”. Pressing and releasing the switch cycles through choices (None, 5% to (Amber choice -5%)). After 5 seconds of inactivity the chosen values are saved, and status of the battery charge functions accordingly.

4. UART communication

The following UART commands UART are implemented in IS-S0109DEM.

64 images can be downloaded to flash using the Engineering Kits Communicator software.

Command to download image to flash

Name	Command	Address	Image data
Bytes	0x28	0x00XX	120 bytes
Send Format	HEX	ASCII HEX	ASCII HEX

The valid addresses are from 0x0001 to 0x0040. Controller respond with 0x6179. Please note when downloading to flash. All the function get disabled.

Command to disable all the functions

Name	Command
Bytes	0X2161
Send Format	HEX

Controller respond with 0x6179

Command to enable all the functions

Name	Command
Bytes	0x2162
Send Format	HEX

Controller respond with 0x6179

Command to upload the set up

Name	Command
Bytes	0X2655
Send Format	HEX

Controller respond with 0x61, Battery LED amber level, Battery LED red level, Backlight brightness level, LCD contrast, 79

Command to set LED backlight brightness

Name	Command	LED Brightness
Bytes	0x2165	0x0X
Send Format	HEX	HEX

There are 8 backlight levels (0x07 to 0x00). 0x00 is the brightest level
Controller respond with 0x6179

Command to set LCD contrast

Name	Command	LCD Contrast
Bytes	0x2166	0xXX
Send Format	HEX	ASCHEX

This produce the voltage for LCD. The default is 0xE0. There is no need to change this value unless for extreme temperature.

Controller respond with 0x6179

Command to save the set up

Name	Command
Bytes	0x2167
Send Format	HEX

Controller save LED brightness AND level, LCD contrast. Controller respond with 0x6179

Command to set amber and red color for the battery

Name	Command	Amber %	RED %
Bytes	0x2155	0xXX	0xXX
Send Format	HEX	ASCII HEX	ASCII HEX

The Amber present range is 0x00 to 0x63. Red percentage range is 0x00 to less than the amber range. Controller respond with 0x6179

Command to check the connection

Name	Command
Bytes	0x01
Send Format	HEX

Controller respond with 0x61, Firmware version, 0x79

Command to display image from flash

Name	Command	Image address
Bytes	0x2D	0xXX
Send Format	HEX	HEX

The acceptable image address range is from 0x01 to 0x40
Controller respond with 0x6179

Command to fill the image with the fill byte

Name	Command	Fill byte
Bytes	0x2761	0xXX
Send Format	HEX	ASCII HEX

All the image bytes are replaced with the indicated byte
Controller respond with 0x6179

Command to fill the indicated pixel row data with the fill byte

Name	Command	Start row address	Fill byte
Bytes	0x2762	0xXX	0xXX
Send Format	HEX	HEX	ASCII HEX

The start row range is from 0x00 to 0x17
Controller respond with 0x6179

Command to create the image of the 6 characters (Font5x7) from indicated start address

Name	Command	Start address	Characters (6)
Bytes	0x2763	0xXX	0xXX
Send Format	HEX	HEX	HEX

The start address range is from 0x00 to 0x11
Controller respond with 0x6179

Command to create the image of the 4 characters (Font7x10) from indicated start address

Name	Command	Start address	Characters (4)
Bytes	0x2765	0xXX	0xXX
Send Format	HEX	HEX	HEX

The start address range is from 0x00 to 0x0E
Controller respond with 0x6179

Command to change the backlight color

Name	Command	LED code
Bytes	0x2755	0xXX
Send Format	HEX	HEX

Controller respond with 0x6179

Command to change PWM duty cycle

Name	Command	Duty cycle
Bytes	0x2757	0xXX
Send Format	HEX	ASCII HEX

Duty cycle range from 0x00 to 0xFF.
Controller respond with 0x6179

Command to create a bar graph

Name	Command	Start address	level
Bytes	0x2753	0xXX	0xXX
Send Format	HEX	HEX	HEX

The start address range is from 0x00 to 0x14. The level is from 0x00 to 0x22
Controller respond with 0x6179

Command to upload the analog and digital status

Name	Command
Bytes	0X2F
Send Format	HEX

Controller respond with 0x61, analog and digital data (10 bytes) ,0x79. The pins are scanned every 12ms.

Analog and Digital data format

Byte #	Byte	Description
1	High byte Analog1	All the analog are scanned 4 time and sum of the 4 times are reported. The maximum value is 0x0FFC

2	Low byte Analog1	
3	High byte Analog2	
4	Low byte Analog2	
5	High byte Analog3	
6	Low byte Analog3	
7	High byte Analog4	
8	Low byte Analog4	
9	Digital OR status	This is OR of every scan since the last upload
10	Digital status	B0 to B3 is digital 1 to 4. B6=RC3, B7=RC4

5. Hardware

Controls Overview

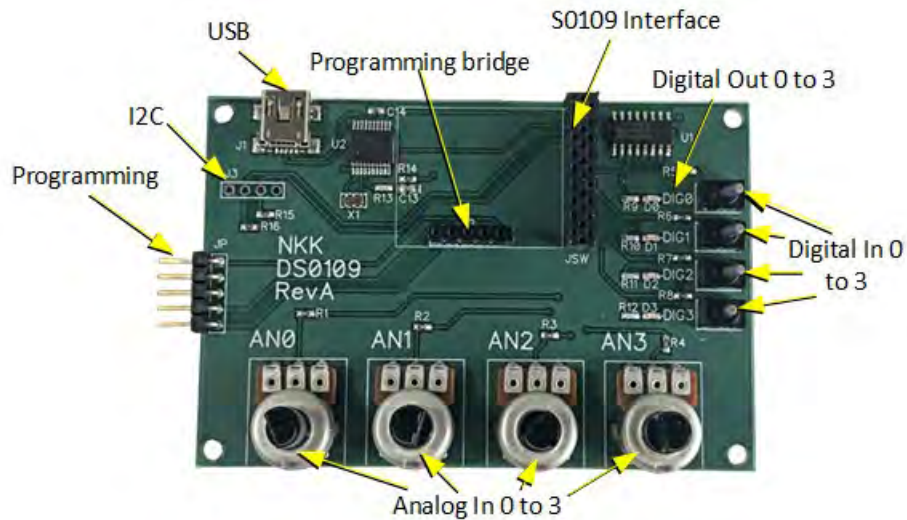

Note: Improper installation of the Single Switch Solution could damage the units.

The **Analog In** has four potentiometers that simulate analog input signals.

Pin	Function
Analog 0	Battery
Analog 1	10 bits
Analog 2	Voltmeter
Analog 3	Stepper

The **Digital In/Out** has four on/off toggles that simulate digital input signals and four LED's that simulate digital output signals. Note that the Digital In and Digital Out are connected so the pin can only be used for one or the other. Digital 0 and 1 are used for output. Digital 2 and 3 are used for input.

Pin	Input or Output	Function
Digital 0	Output	LED lit when AN0 is below warning level and higher than danger level.
Digital 1	Output	LED lit when AN0 is lower than danger level.
Digital 2	Input	ON/OFF the timer
Digital 3	Input	Counter

The **9-15V DC Power jack** mates with a 2.5mm cylinder power connector with a center positive.

The **Programming Connector** links the Single Switch Solution to the firmware programmer such as the PICKit 3 or 4 by Microchip. The unit must have power to program. Also, the five-pin programming bridge should be installed into the 5x1 female header, so the unit is connected to the Single Switch Solution. It should be removed after programming to prevent stray signals.

	1	2	3	4	5
Program	MCLR	VDD	GND	PGD	PGC

6. Schematics

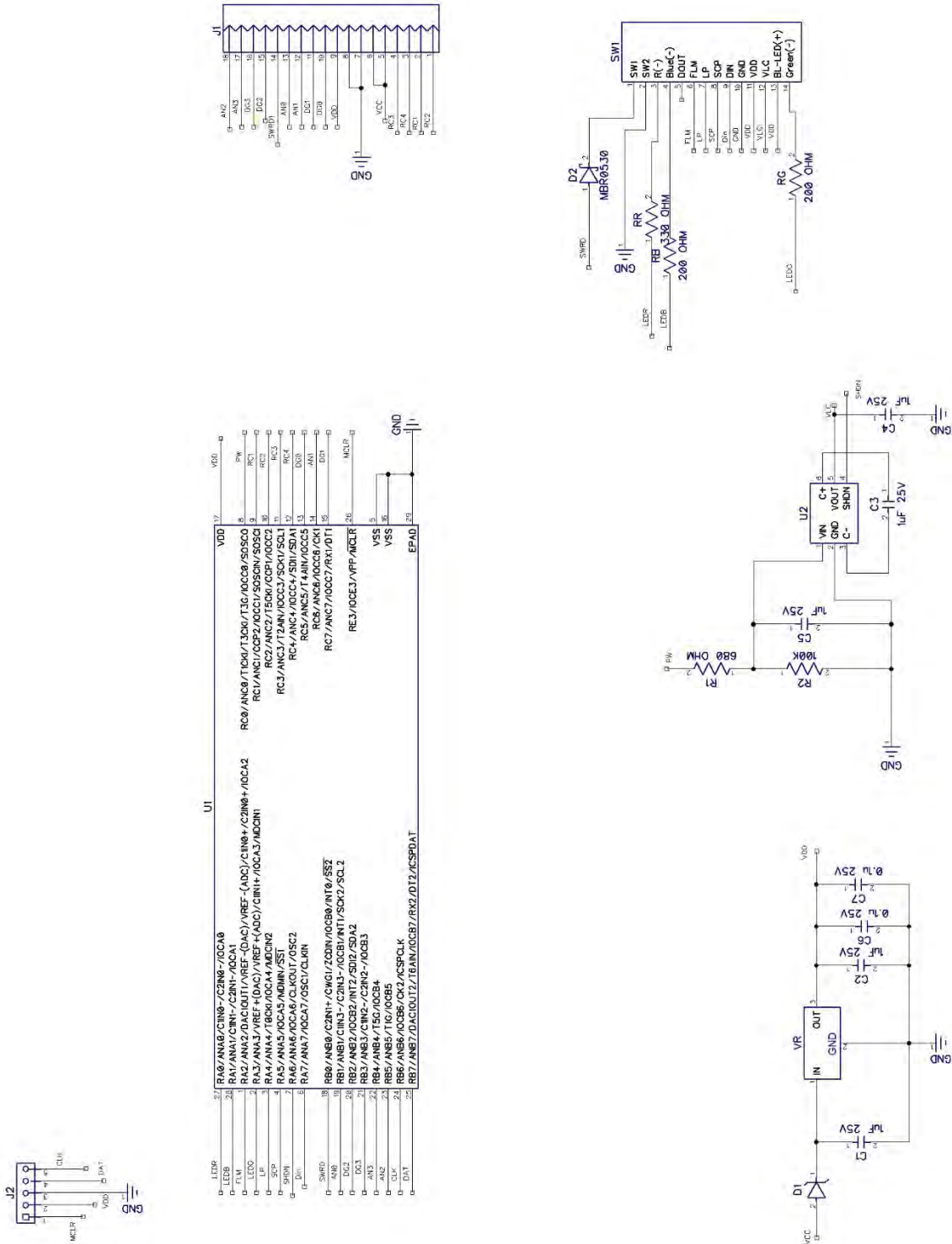

Programming S0109 Single Switch Solution

1. Preparing the IS-S0109Dem for Programming

The **Programming Connector** links the Single Switch Solution to the firmware programmer such as the PICKit 3 by Microchip.

1. The unit must have power to program.
2. The five-pin programming bridge should be installed into the 5x1 female header, so the unit is connected to the Single Switch Solution. It should be removed after programming to prevent stray signals. Make sure there is contact between the connector and pads on the bottom of the S0109.
3. Pin one on the programmer must be connected to pin one on the programming connector. Plugging it in wrong may damage the unit or the programmer or both.

	1	2	3	4	5	6
Program	MCLR	VDD	GND	PGD	PGC	

Single Switch Solution with programmer attached.

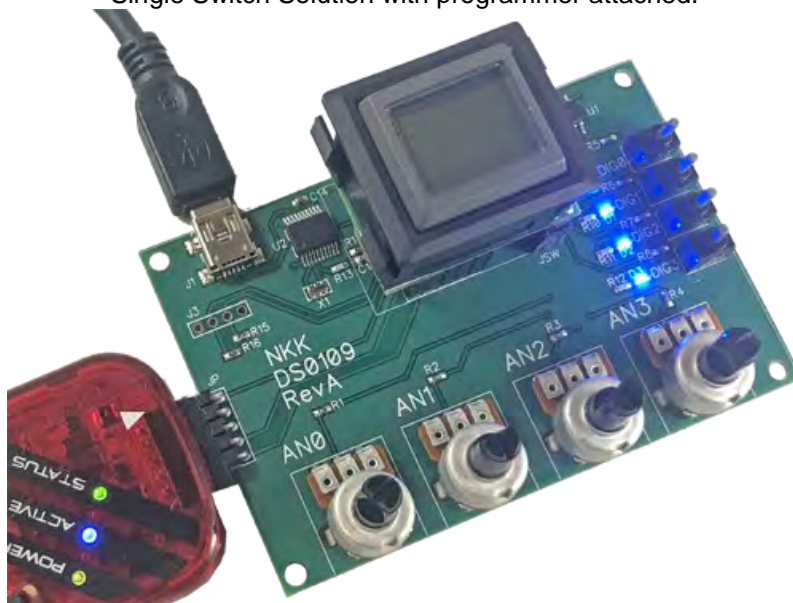

2. Preparing the MPLAB Program

Note: These instructions are for PICKit 3 and MPLAB X IDE v5.10. The version will change at Microchip's discretion.

1. Open MPLAB X IDE program.
2. Select **File**, then **Import**, then **Hex/ELF... (Prebuilt) file**.
3. Prebuilt Filename: **IS0109DEM20.X.Hex**.

4. Device: PIC18F26K40-I/MV.
5. Hardware Tool: PICKit3.
6. All else leave the same.

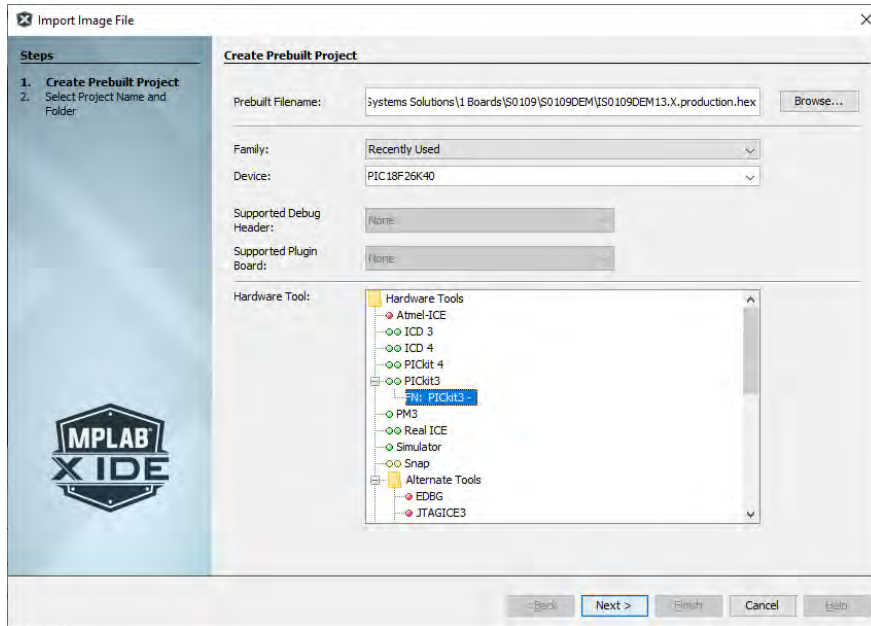

7. Click on **Next>**.
8. Select a Project Name and click on **Finish**.

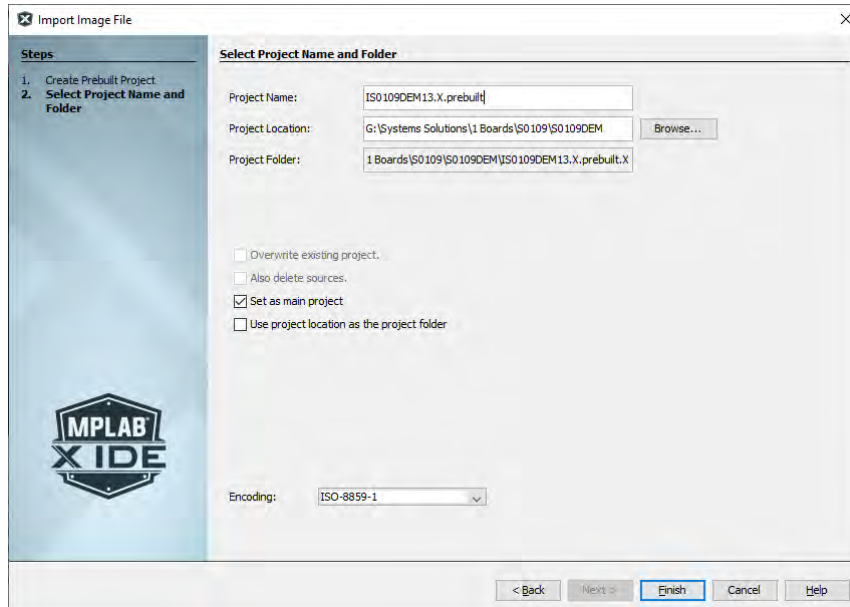

9. Click on the project's folder and open it.
10. Open the "Prebuilt Files" folder and select the hex file.

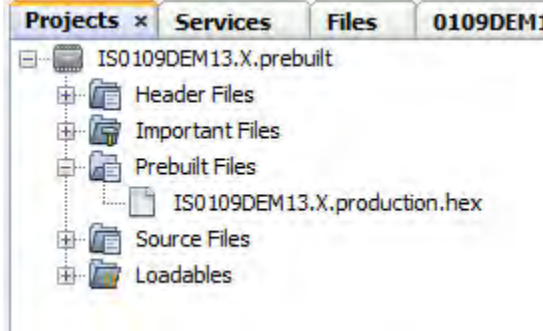

3. Programming the S0109

1. Click on the **Make and Program Device** icon . Then name of the project should be displayed in the drop down.
2. Be sure to hold gently hold down the S0109 unit while it is programming.
3. Ignore any Programming warnings. Click "OK" button.
4. MPLAB IDE will say:
 - Programming...
 - Programming/Verify complete
5. Programming complete.

```

Output x
PICkit 3 x IS0109DEM13.X.prebuilt (Load, Run) x
*****

Connecting to MPLAB PICkit 3...

Currently loaded firmware on PICkit 3
Firmware Suite Version.....01.54.00
Firmware type.....PIC18F

Now Downloading new Firmware for target device: PIC18F26K40
Downloading AP...
AP download complete
Programming download...

Currently loaded firmware on PICkit 3
Firmware Suite Version.....01.54.00
Firmware type.....Enhanced Midrange

Target voltage detected
Target device PIC18F26K40 found.
Device Revision ID = a043

Device Erased...

Programming...

The following memory area(s) will be programmed:
program memory: start address = 0x0, end address = 0x407f
configuration memory
User Id Memory
Programming/Verify complete
|

```

Common Errors:

1. **Target device was not found (could not detect target voltage VDD). You must connect to a target device to use PICkit 3.**
 - Check that the connections are attached. Wiggle the S0109 around.
2. **Target Device ID (0x0) is an Invalid Device ID. Please check your connections to the Target Device.**
 - Wiggle the S0109 around. Make sure the programming connection has proper contact.

4. Testing

1. Unplug power plug.
2. Remove PICkit 3 from unit.
3. Remove Single Switch Solution from the IS-S0109DEM board.
4. Remove programming bridge.
5. Plug in Single Switch Solution back onto IS-S0109DEM board.



6. Plug in power plug.
7. Adjust analog pots, IS pushbutton, and digital switches as necessary to verify that the unit is working as expected.

Notes:

- If any of the analog pins are used as digital output, make sure the corresponding potentiometer is in a middle position while programming.
- If the pins are assigned as digital OUT and the potentiometer is all the way to one side or the other, it may cause damage to the unit.
- If the pins are assigned as digital IN the potentiometer should not be left to produce voltage between 0.6V to 2V.

Warranty

NKK SWITCHES LIMITED WARRANTY AND LIMITATION OF LIABILITY

The following limits our liability. Please read.

NKK Switches hereby warrants this product against any and all manufacturing defects for a period of one year from the date of sale of this product to the original end user. NKK Switches' liability in the event of such defect is limited to repair or replacement of the defective products. NKK Switches disclaims any liability or warranty obligation with respect to any product that is misused, damaged by any user, or not used in conformity with all applicable product specifications.

NKK SWITCHES HEREBY DISCLAIMS ANY WARRANTY, EXPRESS OR IMPLIED, OTHER THAN THAT CONTAINED HEREIN. NKK SWITCHES EXPRESSLY DISCLAIMS THE WARRANTIES OF MERCHANTABILITY AND FITNESS FOR A PARTICULAR PURPOSE, AND SHALL HAVE NO LIABILITY BASED ON OR ARISING FROM ANY CLAIM OF SUCH WARRANTY.

NKK Switches shall have no liability to any person for any incidental, consequential, special, punitive, or other damages of any kind whatsoever relating to any use of this product.

USE OF THIS PRODUCT IN CONNECTION WITH ANY LIFE CRITICAL APPLICATION IS NOT RECOMMENDED.