

Louvered Fan Guards

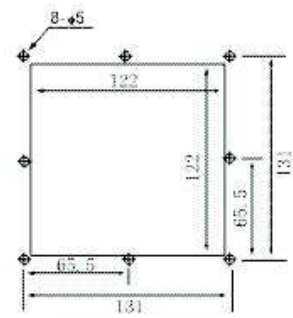

Filter Kits for 120mm (4.7"),
172mm (6.7") & 254mm (10") Fans

LFG120B
Filter kit for
120mm fan

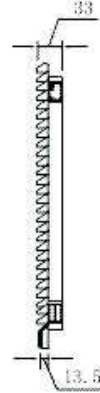
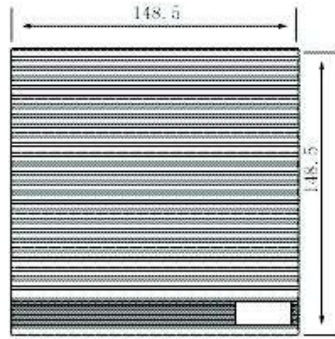

LFG172B
Filter kit for
172mm fan

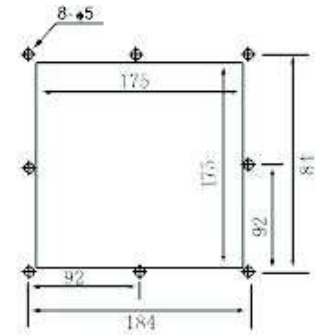
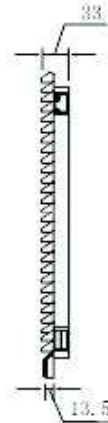
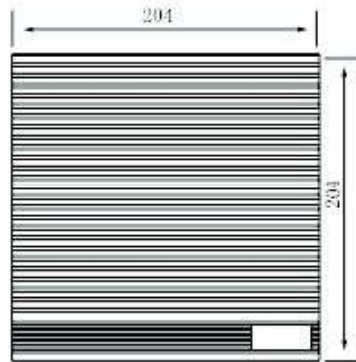

LFG254B
Filter kit for
254mm fan

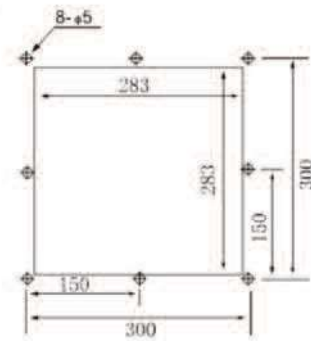
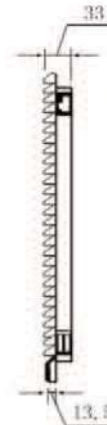
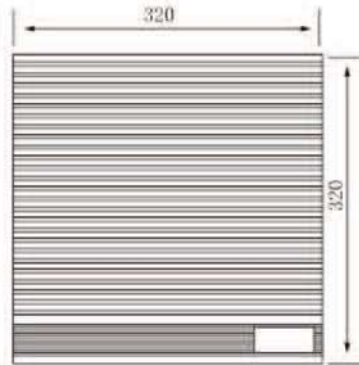

Part Number	LFG120B	LFG172B	LFG254B	Filter Media 5-Packs	
Frame Description	ABS Resin - flame resistant UL94V-0, with UV protection. Vents with screens at 45-degree angle. Includes high foam sealing edge - protection grade IP44-IP54.			Part Number	Description
Filter Mesh Material	Nylon Fiber - Synthetic Resin, filters to 8 microns.			LFG120BF/PK	For LFG120B
Color	Black is standard. Gray (RAL7035) is available on request. To specify gray remove "B" from part number. Minimums may apply.			LFG172BF/PK	For LFG172B
Hardware	1 bag - 8 ea. M4x10, washer, lock washer			LFG254BF/PK	For LFG254B