

Frontplattenausschnitt (Rückseite)
Panel cut out (rear side)

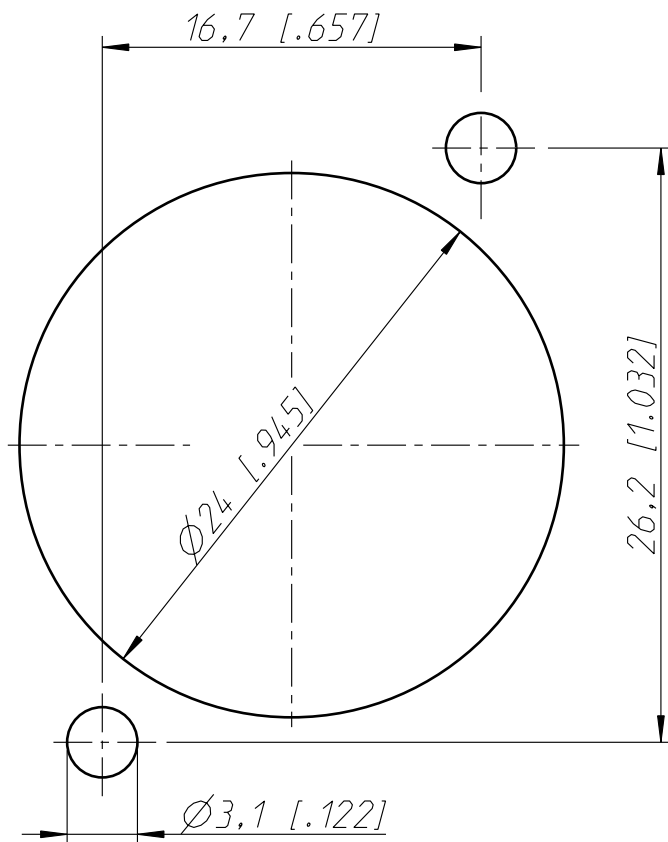

Allgemeintoleranzen ISO 2768-m	Werkstoff	Massstab: 3:1 (A3)	Datum	Name
			Gezeichnet	07.02.96
Zeichnung urheberrechtlich geschuetzt (DIN 34) (C)			Freigegeben	
			Geaendert	19.10.10
Benennung			Aend.-Nr.	Aend.-Index B
NC5FP-1			Ersatz fuer:	Blatt 1 von 1 Bl.
NEUTRIK AG FL-9494 SCHAAN			Zeichn. Nr.	ST-NC5FP-1