



CIE-Group Ltd 3 Widdowson Close Blenheim Ind Est Bulwell Nottingham NG6 8WB England
 T: +44(0)115 9770075 F: +44(0)115 9770081 E: info@cie-group.com W: www.cie-group.com

DWG NO.

201609003

REV	DESCRIPTION	BY	DATE
A	CREATED	xxx	xx/xx/xx

CONFIDENTIAL DOCUMENT! THE INFORMATION CONTAINED IN THIS DRAWING IS THE SOLE PROPERTY OF CIE-GROUP LTD. ANY REPRODUCTION IN PART OR WHOLE WITHOUT THE WRITTEN PERMISSION OF CIE-GROUP LTD IS PROHIBITED.
 The cable assy should comply with the European Parliament and the Council Directive : 2011/65/EU for the restriction of hazardous substances (ROHS) . The manufacturer will provide a certification proving the ROHS compliance of the cable assy whenever customer requires such.

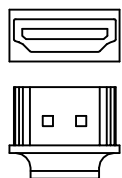
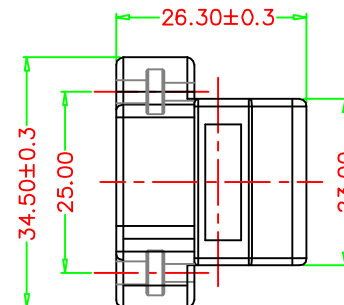
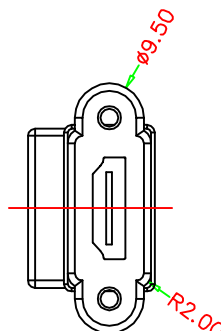
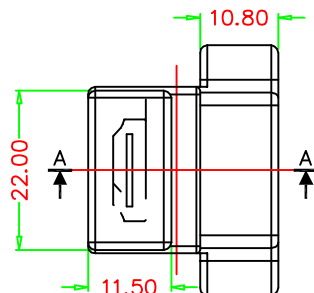
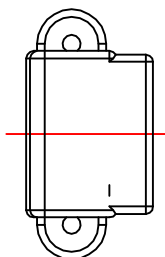
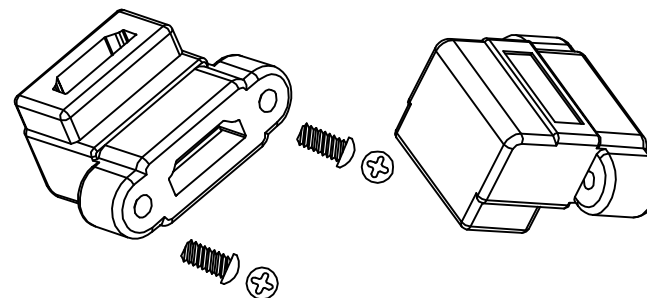
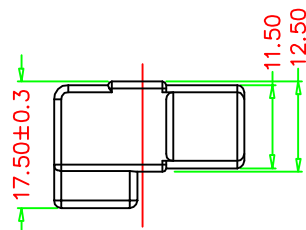

⑥	M3*8mm		
⑤	HDMIC-1	2PCS	
④	BLACK PVC 55P		
③	Tooling: #0708		
②	M3*2.5mm	2PCS	
①	HDMI FEMALE	2PCS	
NO.	DESCRIPTION	QTY	

TOLERANCES
 .XXX ±.025mm
 .XX ±.100mm
 .X ±.250mm

Wire Length
 0-100 ±5mm
 101-300 ±10mm
 301-500 ±15mm
 501-<1000 ±20mm
 1000-<2000 ±50mm
 2000+ ±100mm

TITLE:	HDMI-RA-COUPLEP				
P/N:					
F/C:					
SHEET	PROJECTION	UNIT	DRAWN	VERIFIED	APPROVED
1 OF 1		MM			