

Rotary Gripper

MRHQ Series

Gripper Inside Diameter/Size: $\varnothing 10$, $\varnothing 16$, $\varnothing 20$, $\varnothing 25$

Rotary gripper suitable for holding and reversing workpieces on transfer lines

- Compact integration of gripping and rotating functions
- Eliminates the rotating deflection of piping and wiring caused by the combination of equipment (rotary table + adapter + air gripper)
- Longitudinal dimension reduced by approx. 20% compared with the combined product
- 2 standard rotation angles of 90° and 180°
- Equipped with standard magnet for auto switch retrofitting



Rotary Gripper MRHQ 10/16/20/25

Modular construction

Gripper section is unitized for simple replacement.

Compact bearings add to a light weight and compact design

Simple alignment when mounting body

Provided with reference diameters at the top and bottom of the body, and mounting guide pin holes on three sides of the body along its center axis (aligned with center of body).

Easily mounted from 5 directions: 2 ends and 3 sides of the body

Bottom mounting Top mounting

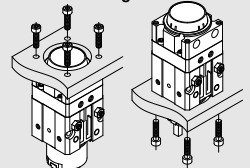

Front mounting
(Through-holes)

Side mounting
(Both sides)

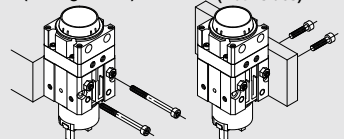

Easy adjustment of rotating range

A scale indicator on the side of the gripper unit allows easy angle adjustments and is useful for verification of rotating positions.

Angle adjustment bolts are standard

Angle adjustment bolts allow the rotation range of the gripper unit to be adjusted by $\pm 10^\circ$ for both 90° and 180° rotation angles. ($\pm 5^\circ$ at the end of rotation)

All piping and wiring centralized on one side for easy work operations

Auto switch capable

Switches can be installed to verify positions for opening and closing of the gripper and the end of rotation.

MHZ

MHF

MHL

MHR

MHK

MHS

MHC

MHT

MHY

MHW

-X

MRHQ

MA

D-

MRHQ Series Model Selection

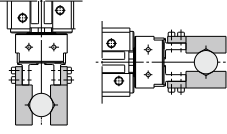
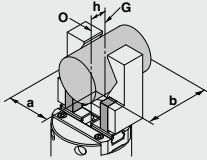
Procedure	Calculation	Example
<p>1 Operating conditions</p> <p>Enumerate the operating conditions according to the mounting position and workpiece configuration.</p>  <p>Vertical mounting Horizontal mounting</p>	<ul style="list-style-type: none"> • Model used • Operating pressure • Mounting position • Rotation time t (s) • Overhang H (mm) • Gripping point distance L (mm) • Distance between central axis and center of gravity h (mm) • Load mass m1 (kg) • Mass of 2 attachments m2 (kg) 	 <p>Rotary gripper: MRHQ16D-90S Pressure: 0.4 MPa Mounting position: Horizontal Rotation time (t): 0.2 s/90° Overhang (H): 10 mm Gripping point distance (L): 20 mm Distance between central axis and center of gravity (h): 10 mm Load mass (m1): 0.07 kg Mass of 2 attachments (m2): 0.05 kg</p>
<p>2 Rotation time</p> <p>Confirm that it is within the adjustable rotation time range.</p>	<p>0.07 to 0.3 s/90°</p>	<p>0.2 s/90° OK</p>
<p>3 Overhang and gripping point distance</p> <p>Confirm that the overhang (H) and the gripping point distance (L) are within the operating pressure range limit.</p>	<p>Gripping point range limit Graph (1)</p>	<p>Within the range limit OK</p>
<p>4 Load mass</p> <p>Confirm that the load converted from the load mass is less than 1/20 of the effective gripping force. (A greater margin must be allowed if large impacts will be applied when work pieces are transported.)</p>	<p>$20 \times 9.8 \times m1$ < Effective gripping force (N) Graph (2)</p>	<p>$20 \times 9.8 \times 0.07 = 13.72$ $13.72 \text{ N} < \text{Effective gripping force}$ OK</p>
<p>5 External force on finger</p> <p>Make sure that the vertical load and each moment on finger are within allowable value.</p>	<p>Less than allowable value (Refer to page 755 for the lateral load allowable value and each moment value formulas.)</p>	<p>Downward vertical load by load and attachment: $f = (0.07 + 2 \times 0.05) \times 9.8 = 1.67 \text{ (N)} < \text{Vertical allowable value}$ OK</p>
<p>6 Rotational torque (horizontal mounting only)</p> <p>Convert the weight of the load and attachments (2 pcs.) into a load value and multiply by the overhang (H). Confirm that this value is less than 1/20 of the effective torque.</p>	<p>$20 \times 9.8 \times (m1 + m2) \times H/1000$ < Effective torque (N-m) Graph (3)</p>	<p>$20 \times 9.8 \times (0.07 + 0.05) \times 10/1000 = 0.24$ $0.24 \text{ N-m} < \text{Effective torque}$ OK</p>
<p>7 Find the moment of inertia, "I_R" for the load + attachments (2 pcs.)</p>	<p>$I_R = K \times (a^2 + b^2 + 12h^2) \times (m1 + m2)/(12 \times 10^6)$ (K = 2: Safety factor)</p>	<p>$I_R = 2 \times (20^2 + 30^2 + 12 \times 10^2) \times (0.07 + 0.05)/(12 \times 10^6)$ $= 0.00005 \text{ kg}\cdot\text{m}^2$</p>
<p>8 Kinetic energy</p> <p>Confirm that the kinetic energy of the load + attachments (2 pcs.) is no more than the allowable value.</p> <p>{ Refer to "Moment of Inertia Calculation and Allowable Kinetic Energy". }</p>	<p>$1/2 \times I_R \times (\omega)^2 < \text{Allowable energy (J)}$ $(\omega) = 2\theta/t$ (θ: Angular speed at the end) θ: Rotation angle (rad) t: Rotation time (s)</p>	<p>$1/2 \times 0.00005 \times (2 \times (3.14/2)/0.2)^2 = 0.0062$ $0.0062 \text{ J} < \text{Allowable energy}$ OK</p>

Gripping Point

External gripping

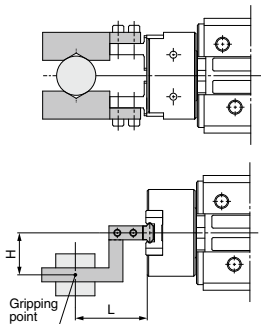

Internal gripping

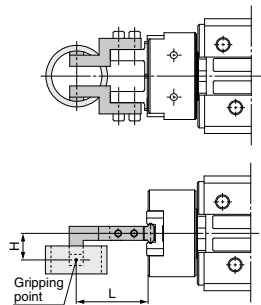

L: Gripping point distance
H: Overhang

- Operate so that the workpiece gripping point distance "L" and the amount of overhang "H" stay within the range shown for each operating pressure given in the graphs above.
- If operated with the workpiece gripping point outside of the range limit, an excessive eccentric load will be applied to the fingers and guide section, causing play in the fingers and adversely affecting the gripper's life.

Gripping Point Range Limit

Graph (1)

External Gripping

MRHQ10

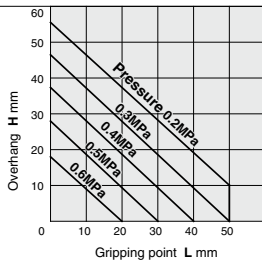

MRHQ16

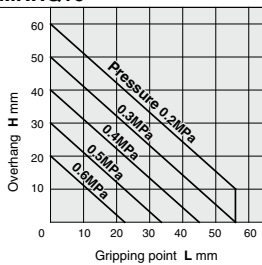

MRHQ20

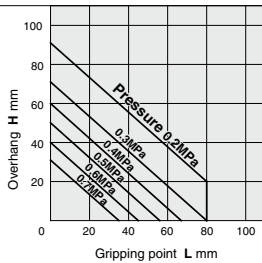

MRHQ25

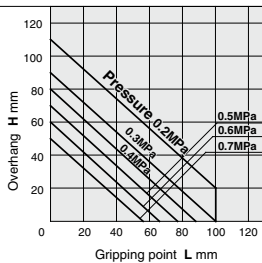

Internal Gripping

MRHQ10

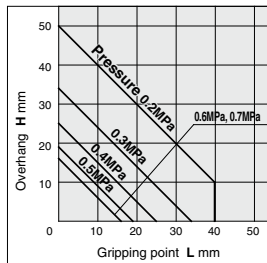

MRHQ16

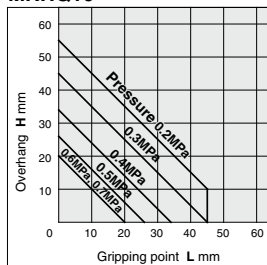

MRHQ20

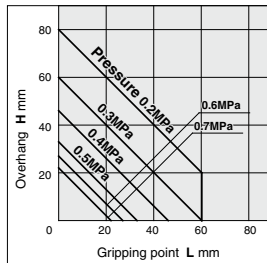

MRHQ25

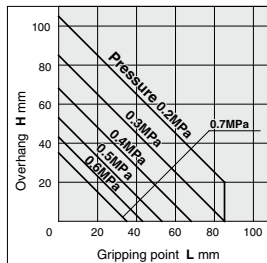

MHZ

MHF

MHL

MHR

MHK

MHS

MHC

MHT

MHY

MHW

-X□

MRHQ

MA

D-□

MRHQ Series

Effective Gripping Force

Expressing the effective gripping force

The effective gripping force shown in the graphs to the right is expressed as F , which is the impellent force of one finger, when both fingers and attachments are in full contact with the workpiece as shown in the figure below.

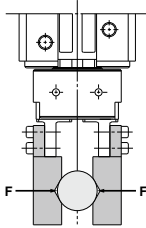

External gripping

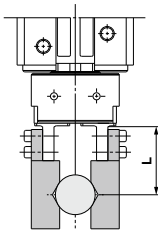

Internal gripping

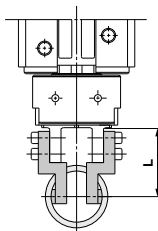

L: Gripping point distance (mm)

Model Selection Guidelines by Workpiece Mass

- Although conditions differ according to the workpiece shape and the coefficient of friction between the attachments and the workpiece, select a model that can provide a gripping force of 10 to 20 times the workpiece mass, or more.
- A greater margin of safety is required when high acceleration or impact occurs during workpiece transfer.

Effective Gripping Force

External Gripping/Double Acting

MRHQ10D

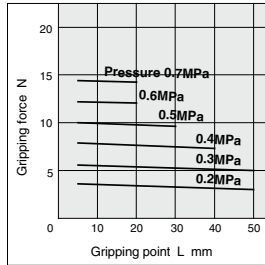

MRHQ16D

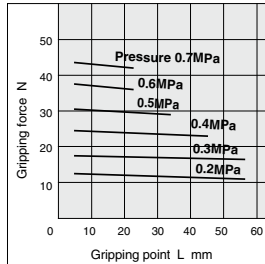

MRHQ20D

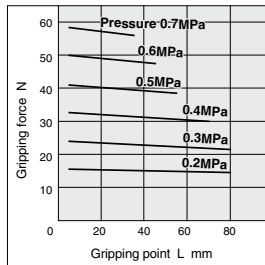

MRHQ25D

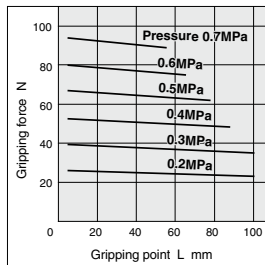

Internal Gripping/Double Acting

MRHQ10D

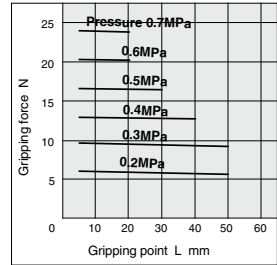

MRHQ16D

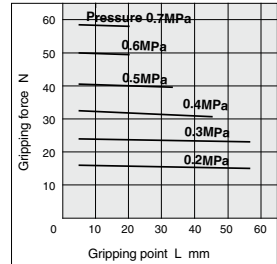

MRHQ20D

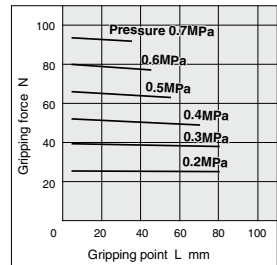

MRHQ25D

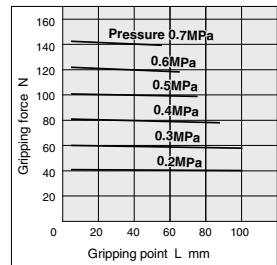

External Gripping Force/Single Acting

MRHQ10S

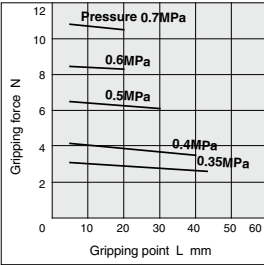

MRHQ16S

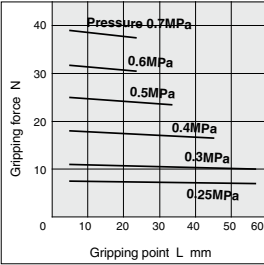

MRHQ20S

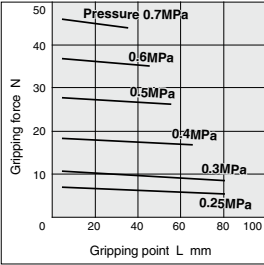

MRHQ25S

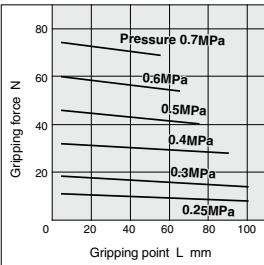

Internal Gripping Force/Single Acting

MRHQ10C

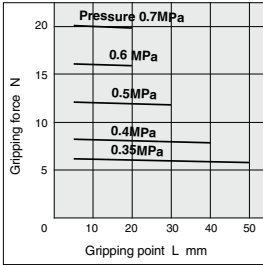

MRHQ16C

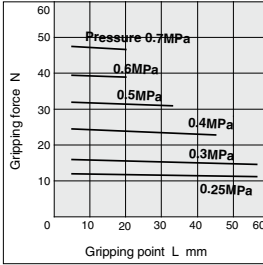

MRHQ20C

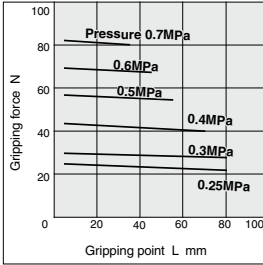

MRHQ25C

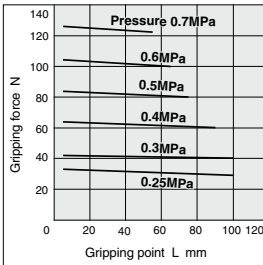

- MRHZ
- MRHF
- MRHL
- MRHR
- MRHK
- MRHS
- MRHC
- MRHT
- MRHY
- MRHW
- X
- MRHQ
- MA
- D-

MRHQ Series

Rotational Torque and Gripping Point

Rotational Torque

Graph (3)

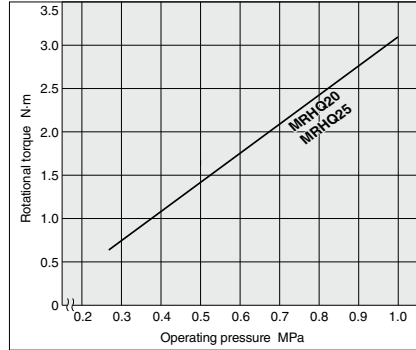
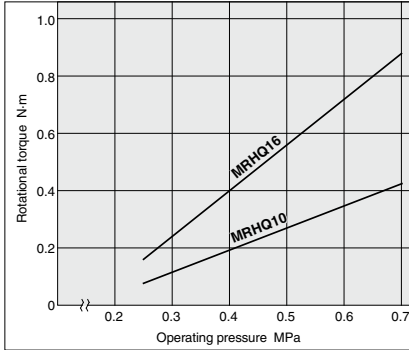

How to Mount Attachment on Fingers

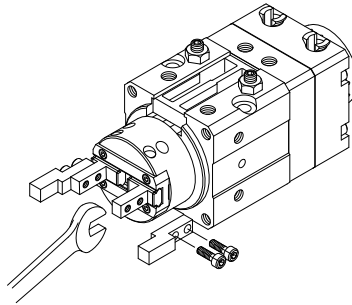

When mounting attachments on fingers, support the fingers with a tool such as a spanner to prevent them from twisting. Refer to the table on the right for the tightening torques of finger mounting bolts.

Model	Bolt	Max. tightening torque N·m
MRHQ10	M2.5 x 0.45	0.31
MRHQ16	M3 x 0.5	0.59
MRHQ20	M4 x 0.7	1.4
MRHQ25	M5 x 0.8	2.8

Allowable Value of External Force on Fingers

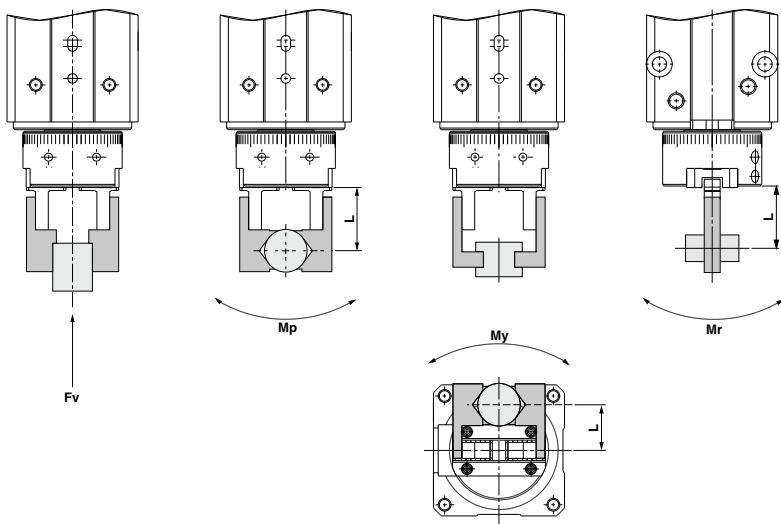

L: Distance to the point at which a load is applied (mm)

Model	Allowable vertical load Fv (N)	Maximum allowable moment		
		Pitch moment Mp (N·m)	Yaw moment My (N·m)	Roll moment Mr (N·m)
MRHQ10□	58	0.26	0.26	0.53
MRHQ16□	98	0.68	0.68	1.36
MRHQ20□	147	1.32	1.32	2.65
MRHQ25□	255	1.94	1.94	3.88

Note) Values of load and moment in the above table are static values.

Calculation for allowable external force (with moment load)	Calculation example
$\text{Allowable load } F \text{ (N)} = \frac{M \text{ (Maximum allowable moment) (N·m)}}{L \times 10^{-3}}$ <p style="text-align: center;">* Unit conversion factor</p>	<p>When static load $f = 10$ N, which produces pitch moment to the point $L = 30$ mm from MRHQ16D guide, is applied. Operable condition requires that F be bigger than f.</p> <p>Example:</p> $\text{Allowable load } F = \frac{0.68}{30 \times 10^{-3}} = 22.7 \text{ (N)} > 10$ <p>Since load $F > f$, it is operable.</p>

- MHZ
- MHF
- MHL
- MHR
- MHK
- MHS
- MHC
- MHT
- MHY
- MHW
- X□
- MRHQ
- MA
- D-□

Moment of Inertia and Allowable Kinetic Energy

Moment of Inertia Calculation and Allowable Kinetic Energy

Calculate the moment of inertia as shown below, and confirm that the operating conditions are within the allowable kinetic energy shown in the graph "Moment of inertia and rotation time" on the right.

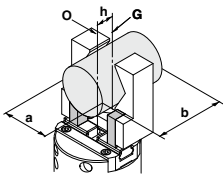

When load dimensions > attachment dimensions

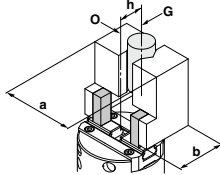

When load dimensions < attachment dimensions

Description

- O Center of rotation
- G Center of gravity of attachment and load
- Gripper fingers
- Attachments
- Load

Moment of inertia I : kg·m²

$$I = \frac{(a^2 + b^2 + 12h^2)(m1 + m2)}{12 \times 10^6}$$

m1: Mass of two attachments (kg)

m2: Mass of load (kg)

h: Distance between O and G (mm)

a, b: Dimensions of load or attachment (mm)

K = 2 (Coefficient)

$I_n = K \times I$

* Use I_n for this product.

Graph (Moment of inertia and rotation time)

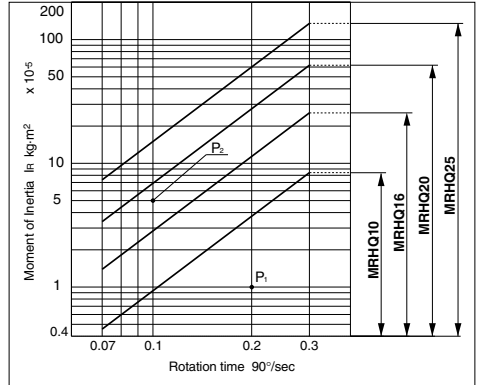

How to Use the Graph

[Example 1]

- Moment of Inertia: 1×10^{-5} kg·m²
- Rotation time: 0.3 s/90°
- To select model **MRHQ10**

It can be used because the point of intersection **P₁** on the graph is within the limiting range.

[Example 2]

- Moment of Inertia: 5×10^{-5} kg·m²
- Rotation time: 0.1 s/90°
- To select model **MRHQ16**

It cannot be used because the point of intersection **P₂** on the graph is outside the range limit. (Review is necessary.)

To confirm by calculation, use formula (1) on the right and check that the kinetic energy of load E is within the allowable values below.

Kinetic energy of load E: J

$$E = 1/2 \times I_n \times \omega^2 \dots (1)$$

Allowable Kinetic Energy

Model	Allowable value J
MRHQ10□	0.0046
MRHQ16□	0.014
MRHQ20□	0.034
MRHQ25□	0.074

$$\omega = 2\theta/t$$

ω : Angular speed at the end

θ : Rotating angle (rad)

t : Rotation time (s)

Rotary Gripper

MRHQ Series

How to Order

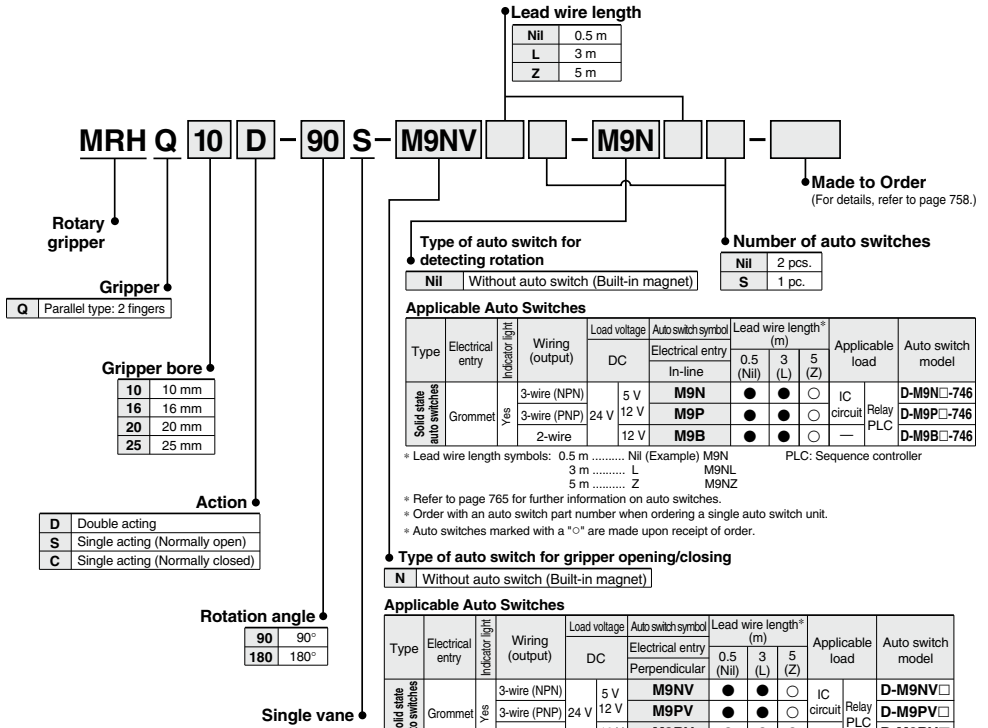

- MHZ
- MHF
- MHL
- MHR
- MHK
- MHS
- MHC
- MHT
- MHY
- MHW
- X□
- MRHQ
- MA
- D-□

Unit list

Gripper unit

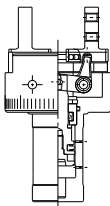

Model	Unit part no.
MRHQ10D	P407090-3D
MRHQ10S	P407090-3S
MRHQ10C	P407090-3C
MRHQ16D	P407060-3D
MRHQ16S	P407060-3S
MRHQ16C	P407060-3C
MRHQ20D	P407080-3D
MRHQ20S	P407080-3S
MRHQ20C	P407080-3C
MRHQ25D	P408080-3D
MRHQ25S	P408080-3S
MRHQ25C	P408080-3C

Switch mounting unit

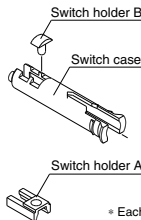

Model	Unit part no.
MRHQ10□	P407090-1
MRHQ16□	
MRHQ20□	P407060-1
MRHQ25□	

- * Each unit includes two of each of the parts indicated left.
- * Auto switches are not included with a unit.



Made to Order

(For details, refer to pages 768 to 770.)

Symbol	Specifications
-X50	Flat type fingers
-X51	Through-holes in opening/closing direction
-X11□	Air gripper with dust cover

Specifications

Model		MRHQ10	MRHQ16	MRHQ20	MRHQ25
Fluid		Air			
Operating pressure	Rotary unit	0.25 to 0.7 MPa		0.25 to 1.0 MPa	
	Gripper unit	Double acting	0.1 to 0.7 MPa		
		Single acting	0.35 to 0.7 MPa		
Rotation angle		90° ±10°, 180° ±10° (Both ends of rotation ±5° adjustable)			
Gripper action		Double acting, Single acting			
Finger opening/closing repeatability		±0.01 mm			
Gripper maximum operating frequency		180 c.p.m			
Ambient and fluid temperature		5 to 60°C			
Adjustable rotation time range (1)		0.07 to 0.3 s/90° (at 0.5 MPa)			
Allowable kinetic energy		0.0046 J	0.014 J	0.034 J	0.074 J
Auto switch	Rotary unit	Solid state auto switch (2-wire, 3-wire)			
	Gripper unit	Solid state auto switch (2-wire, 3-wire)			

Note 1) Operate within the speed adjustment range, as speed control exceeding the limit value of the low speed may cause sticking or failure to operate.

Model

Action	Model	Cylinder bore (mm)	Opening/Closing stroke (mm)	Rotating angle (°)	Weight (g) ⁽¹⁾
Double acting	MRHQ10D	10	4	90	306
				180	305
	MRHQ16D	16	6	90	593
				180	591
	MRHQ20D	20	10	90	1055
				180	1052
MRHQ25D	25	14	90	1561	
			180	1555	
Single acting	MRHQ10S MRHQ10C	10	4	90	307
				180	306
	MRHQ16S MRHQ16C	16	6	90	594
				180	592
	MRHQ20S MRHQ20C	20	10	90	1060
				180	1057
	MRHQ25S MRHQ25C	25	14	90	1566
				180	1560

Note 1) Values do not include auto switch weight.

Gripper Rotation Range/View from Gripper Side

- The figure at the right indicates the position of the gripper when pressure is applied to port B.
- When pressure is applied to port A, the gripper rotates clockwise.
- Both ends of vibration can be adjusted ± 5° with the adjusting bolt.

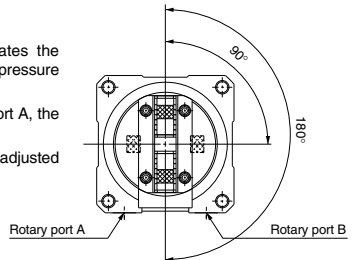

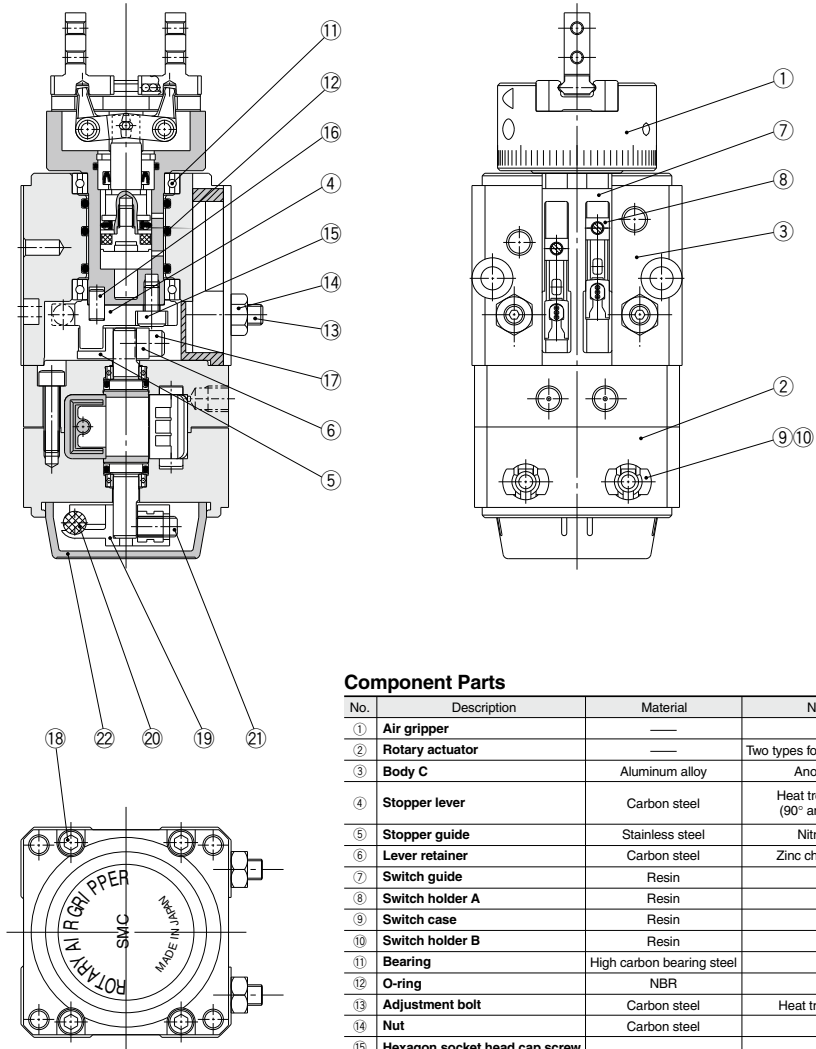
Construction

Component Parts

No.	Description	Material	Note
①	Air gripper	—	
②	Rotary actuator	—	Two types for 90° and 180°
③	Body C	Aluminum alloy	Anodized
④	Stopper lever	Carbon steel	Heat treatment (90° and 180°)
⑤	Stopper guide	Stainless steel	Nitriding
⑥	Lever retainer	Carbon steel	Zinc chromated
⑦	Switch guide	Resin	
⑧	Switch holder A	Resin	
⑨	Switch case	Resin	
⑩	Switch holder B	Resin	
⑪	Bearing	High carbon bearing steel	
⑫	O-ring	NBR	
⑬	Adjustment bolt	Carbon steel	Heat treatment
⑭	Nut	Carbon steel	
⑮	Hexagon socket head cap screw		
⑯	Parallel pin	Stainless steel	
⑰	Hexagon socket head cap screw		
⑱	Hexagon socket head cap screw		
⑲	Magnet lever	Resin	
⑳	Magnet		Nickel plated
㉑	Hexagon socket head set screw		
㉒	Resin case	Resin	

* Individual part cannot be shipped. Please purchase the whole unit. (Refer to pages 757 and 771.)

MHZ

MHF

MHL

MHR

MHK

MHS

MHC

MHT

MHY

MHW

-X□

MRHQ

MA

D-□

MRHQ Series

Dimensions

MRHQ10

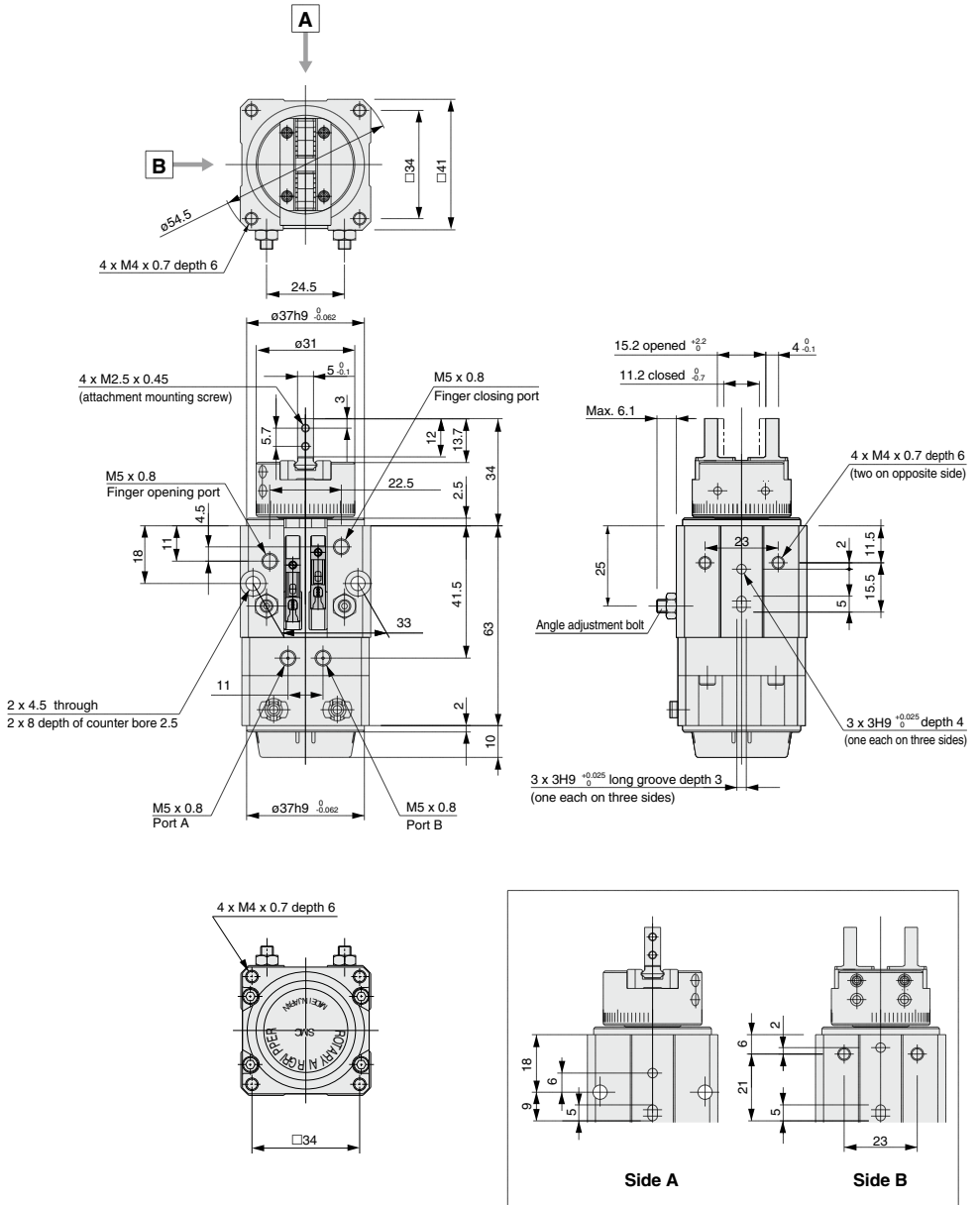

Dimensions

MRHQ16

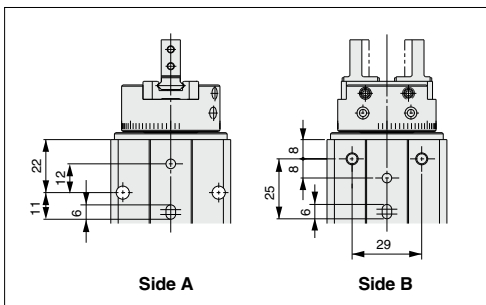
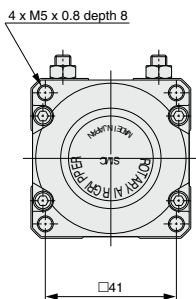
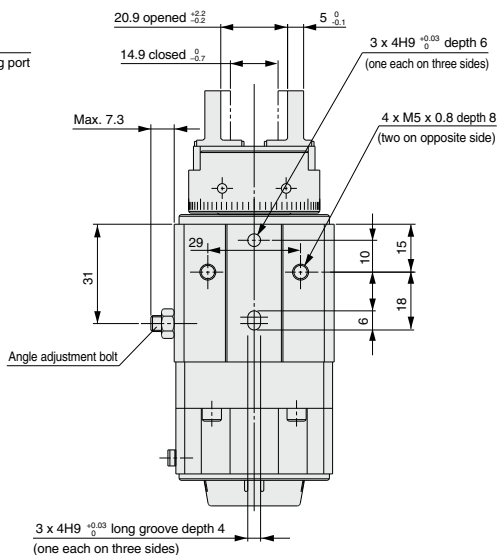
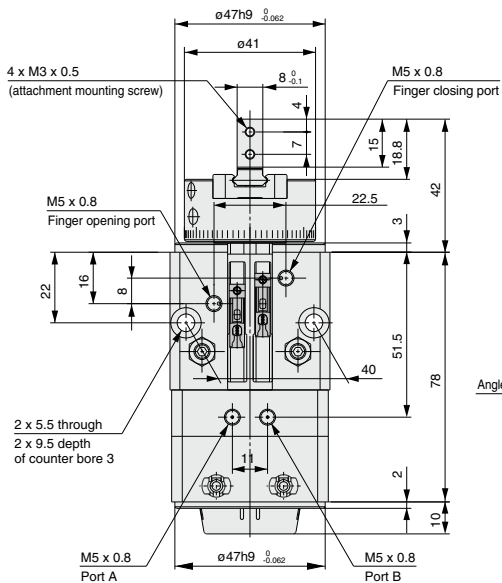
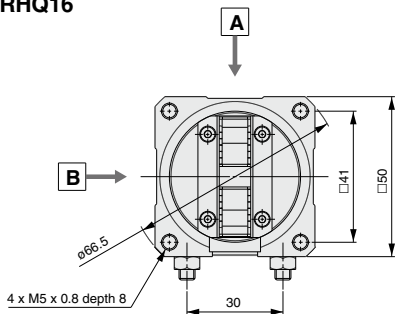

- MRHZ
- MRHF
- MRHL
- MRHR
- MRHK
- MRHS
- MRHC
- MRHT
- MRHY
- MRHW
- X□
- MRHQ
- MA
- D-□

MRHQ Series

Dimensions

MRHQ20

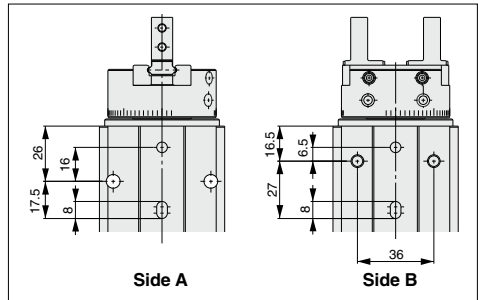
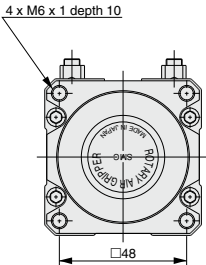
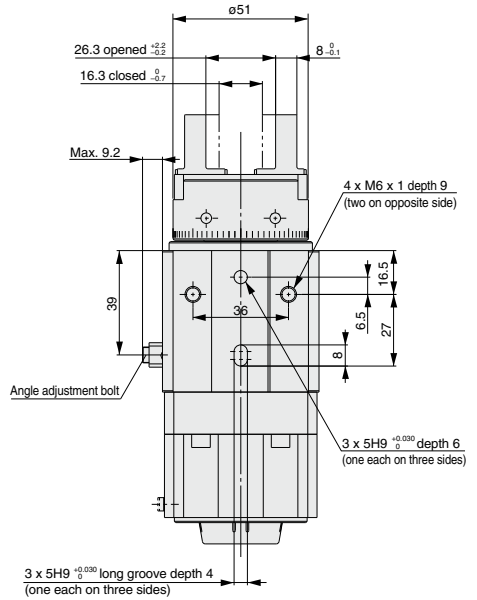
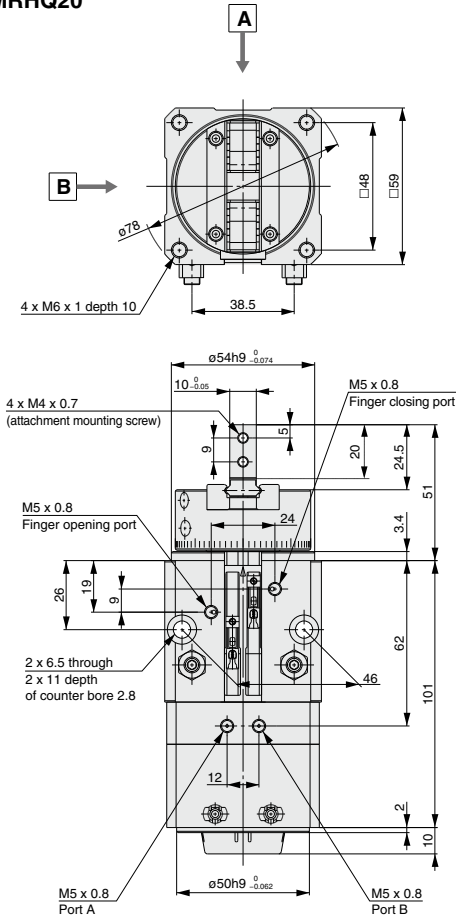

Dimensions

MRHQ25

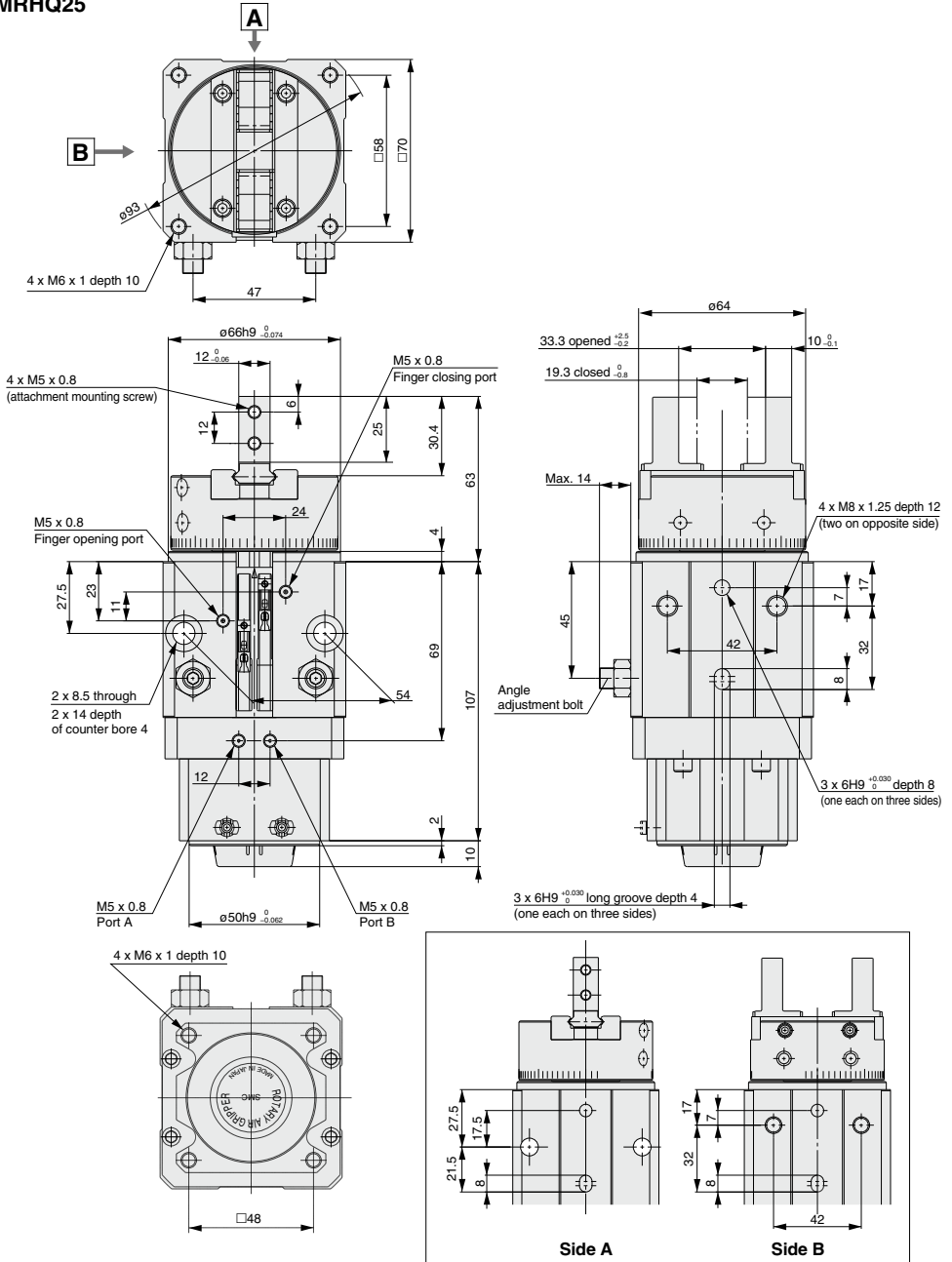

- MRHZ
- MRHF
- MRL
- MHR
- MHK
- MHS
- MHC
- MHT
- MHY
- MHW
- X□
- MRHQ
- MA
- D-□

Auto Switch Specifications

Applicable Series

Series	Application	Auto switch model	Electrical entry
MRHQ10 MRHQ16	Gripper opening/ closing verification	Solid state	D-M9BV Grommet/2-wire
			D-M9NV,M9PV Grommet/3-wire
MRHQ20 MRHQ25	Rotation verification	Solid state	D-M9B-746 Grommet/2-wire
			D-M9N-746,M9P-746 Grommet/3-wire

Auto Switch Hysteresis

Auto switches have hysteresis similar to micro switches. Use the table below as a guide when adjusting auto switch positions, etc.

Model	Hysteresis (mm)
MRHQ10	0.5
MRHQ16	0.5
MRHQ20	1.0
MRHQ25	1.0

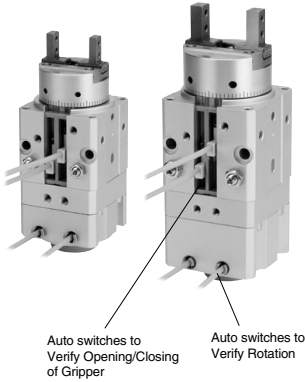
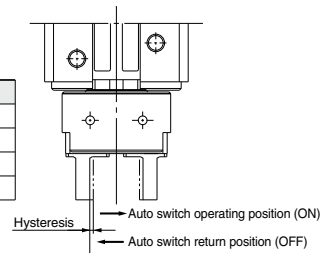

Mounting of Auto Switch

Mounting Auto Switches to Verify Rotation

1. First, remove the slotted set screw installed in a standard switch.

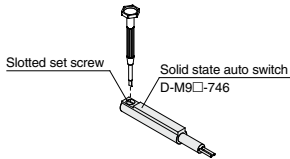

2. Insert the auto switch into the switch case, and install switch holder B into the first groove (MRHQ20/25) or the second groove (MRHQ10/16) and secure the auto switch.

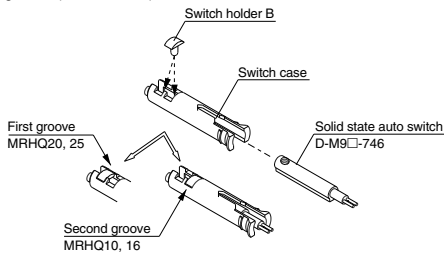

3. Install the auto switch case, with a switch attached securely in the hole, in the direction indicated in Figure (1).

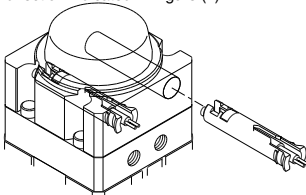

Figure (1)

Mounting Auto Switches to Verify Opening/Closing of Gripper

1. Position switch holder A in the groove of the switch guide in the direction indicated in Figure (2).
2. Insert an auto switch into the switch guide and align the set screw with the hole of switch holder A.

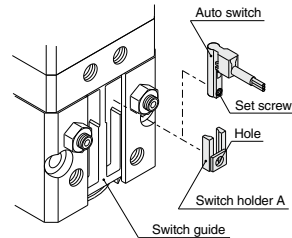

Figure (2)

3. Secure the auto switch at an appropriate position with a flat head watchmakers screwdriver as indicated in Figure (3).

Tightening torque: **0.05 to 0.1 N·m**

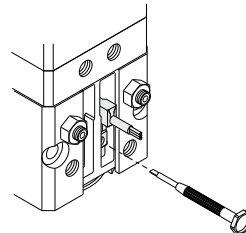

Figure (3)



Grommet

- Reduce the 2-wire load current (2.5 to 40 mA)
- Use a flexible cord as a standard



Auto switch for rotation confirmation

Auto Switch Specifications

PLC: Programmable Logic Controller

D-M9□-746 (With indicator light)			
Auto switch part no.	D-M9N-746	D-M9P-746	D-M9B-746
Electrical entry	Lateral	Lateral	Lateral
Wiring type	3-wire		2-wire
Output type	NPN Type	PNP Type	—
Applicable load	IC circuit, Relay, for PLC		24 VDC relay, for PLC
Power supply	5, 12, 24 VDC(4.5 to 28 V)		—
Current consumption	10 mA or less		—
Load voltage	28 VDC or less	—	24 VDC(10 to 28 VDC)
Load current	40 mA or less		2.5 to 40 mA
Internal voltage drop	0.8 V or less at 10 mA (2 V or less at 40 mA)		4 V or less
Leakage current	100 μA or less at 24 VDC		0.8 mA or less
Indicator light	Red LED illuminates when turned ON.		
Standard	CE marking		

- Lead length symbols: 0.5 m (Example)D-M9N-746
- 3 m (Example)D-M9NL-746
- 5 m (Example)D-M9NZ-746

Oilproof Heavy-duty Cord Specifications

Auto switch models		D-M9N□-746	D-M9P□-746	D-M9B□-746
Sheath	Outside diameter	2.7 x 3.2 ellipse		
Insulator	Number of cores	3-wire (Brown, Black, Blue)		2-wire (Brown, Blue)
	Outside diameter	0.9		
Conductor	Effective area [mm ²]	0.15		
	Strand diameter [mm]	0.05		
Minimum bending radius [mm] (Reference value)		20		

- Note 1) Refer to page 800 for solid state auto switch common specifications.
 Note 2) Refer to page 800 for lead wire lengths.

Auto Switch Weight

Unit: g

Auto switch part no.		D-M9N-746	D-M9P-746	D-M9B-746
Lead wire length	0.5 m (Nil)	8	7	7
	3 m (L)	41	38	38
	5 m (Z)	68	63	63

Auto Switch Dimensions

D-M9N-746/D-M9P-746/D-M9B-746

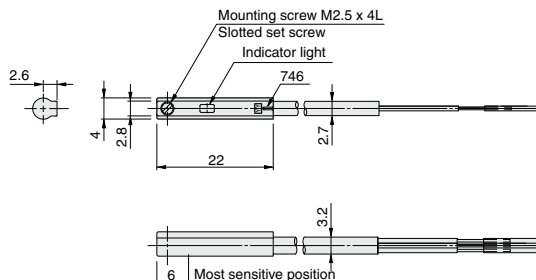

- MHZ
- MHF
- MHL
- MHR
- MHK
- MHS
- MHC
- MHT
- MHY
- MHW
- X□
- MRHQ
- MA
- D-□

MRHQ Series

Auto Switch Installation Examples and Mounting Positions

Various auto switch applications will be available with combinations of using different numbers of auto switches and varieties of detecting positions.

1) Detection when Gripping Exterior of Workpiece

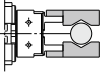
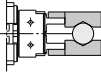
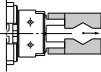
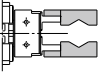
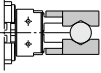
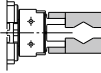
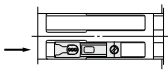
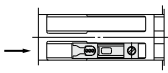
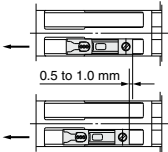
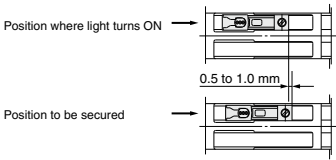

Detection example	1. Confirmation of fingers in reset position	2. Confirmation of workpiece held	3. Confirmation of workpiece released
Position to be detected	Position of fingers fully opened 	Position when gripping a workpiece 	Position of fingers fully closed 
Operation of auto switch	Auto switch turned ON when fingers return. (Light ON)	Auto switch turned ON when gripping a workpiece. (Light ON)	When a workpiece is not held (Abnormal operation): Auto switch to turn ON (Light ON)
Detection combinations	One auto switch • One position, any of ①, ② and ③ can be detected.	●	●
	Two auto switches • Two positions of ①, ② and ③ can be detected.	●	●
	Pattern	—	—
	●	—	●
How to determine auto switch installation position	Step 1) Fully open the fingers. 	Step 1) Position fingers for gripping a workpiece. 	Step 1) Fully close the fingers. 
At no pressure or low pressure, connect the auto switch to a power supply, and follow the directions.	Step 2) Refer to "Mounting Switches to Verify Opening/Closing of Gripper" on page 764 and position an auto switch in auto switch mounting groove.		
	<p>Step 3) Slide the auto switch in the direction of the arrow until the indicator light illuminates.</p>  <p>Step 4) Slide the auto switch further in the direction of the arrow until the indicator light goes out.</p>  <p>Step 5) Move the auto switch in the opposite direction and fasten it at a position 0.5 to 1.0 mm beyond the position where the indicator light illuminates.</p> 	<p>Step 3) Slide the auto switch in the direction of the arrow until the light illuminates and fasten it at a position 0.5 to 1.0 mm in the direction of the arrow beyond the position where the indicator light illuminates.</p> 	

Note) • It is recommended that gripping of a workpiece be performed close to the center of the finger stroke.

• When holding a workpiece close at the end of open/close stroke of fingers, detecting performance of the combinations listed in the above table may be limited, depending on the hysteresis of an auto switch, etc.

Various auto switch applications will be available with combinations of using different numbers of auto switches and varieties of detecting positions.

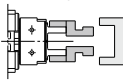
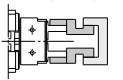
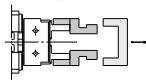
2) Detection when Gripping Interior of Workpiece

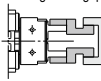
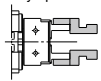
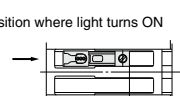
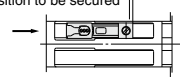
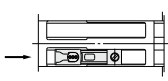
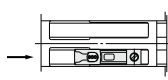
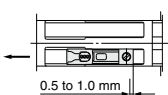
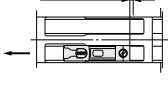
Detection example	1. Confirmation of fingers in reset position	2. Confirmation of workpiece held	3. Confirmation of workpiece released
Position to be detected	Position of fingers fully closed 	Position when gripping workpiece 	Position of fingers fully opened 
Operation of auto switch	Auto switch turned ON when fingers return. (Light ON)	Auto switch turned ON when gripping a workpiece. (Light ON)	When a workpiece is not held (Abnormal operation): Auto switch to turn ON (Light ON)
Detection combinations One auto switch • One position, any of ①, ② and ③ can be detected. Two auto switches • Two positions of ①, ② and ③ can be detected.	●	●	●
	●	●	—
	●	—	●
Pattern	A	B	C
How to determine auto switch installation position	Step 1) Fully close the fingers.. 	Step 1) Position fingers for gripping a workpiece. 	Step 1) Fully open the fingers. 
At no pressure or low pressure, connect the auto switch to a power supply, and follow the directions.	Step 2) Refer to "Mounting Switches to Verify Opening/Closing of Gripper" on page 764 and position auto switch in switch mounting groove.		
	Step 3) Move the auto switch in the direction of the arrow and fasten it at a position 0.5 to 1.0 mm beyond the position where the indicator light illuminates.	Step 3) Slide the auto switch in the direction of the arrow until the indicator light illuminates.	
	 Position where light turns ON 0.5 to 1.0 mm Position to be secured 	 Step 4) Slide the auto switch in the direction of the arrow until the indicator light goes out. 	
	Step 5) Move the auto switch in the opposite direction, and fasten it at a position 0.5 to 1.0 mm in the direction of the arrow beyond the position where the indicator light illuminates.		
	 0.5 to 1.0 mm 		

Note) • It is recommended that gripping of a workpiece be performed close to the center of the finger stroke.
 • When holding a workpiece close at the end of open/close stroke of fingers, detecting performance of the combinations listed in the above table may be limited, depending on the hysteresis of an auto switch, etc.

- MHZ
- MHF
- MHL
- MHR
- MHK
- MHS
- MHC
- MHT
- MHY
- MHW
- X□
- MRHQ
- MA
- D-□

MRHQ Series

Made to Order

Please contact SMC for detailed dimensions, specifications and lead times.



Symbol
-X50

1 Flat Type Fingers

The distance to the workpiece can be shortened.
The finger option of the air gripper MHZ series is mounted.

How to Order

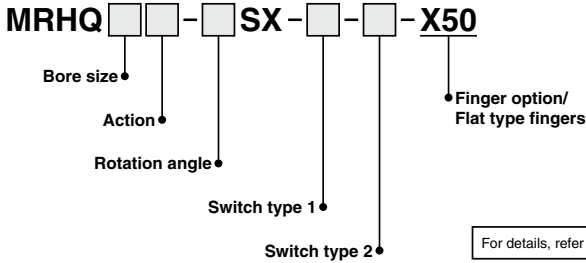

For details, refer to the standard type on page 757.

Dimensions (Dimensions other than shown below are the same as standard type.)

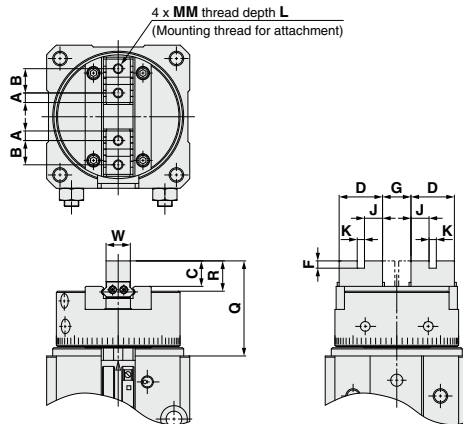

[mm]

Model	A	B	C	D	F	G		J	K	MM	L	R	Q	W
						When open	When closed							
MRHQ10	2.45	6	5.2	10.9	2	$5.4^{+0.2}_0$	$1.4^{+0.2}_0$	4.45	$2H9^{+0.025}_0$	M2.5 x 0.45	5	5.7	25.7	$5^{+0.05}_0$
MRHQ16	3.05	8	8.3	14.1	2.5	$7.4^{+2.2}_0$	$1.4^{+0.2}_0$	5.8	$2.5H9^{+0.025}_0$	M3 x 0.5	6	9.5	32.7	$8^{+0.05}_0$
MRHQ20	3.95	10	10.5	17.9	3	$11.6^{+2.3}_0$	$1.6^{+0.2}_0$	7.45	$3H9^{+0.025}_0$	M4 x 0.7	8	12.5	39.2	$10^{+0.05}_0$
MRHQ25	4.9	12	13.1	21.8	4	$16^{+2.5}_0$	$2^{+0.2}_0$	8.9	$4H9^{+0.025}_0$	M5 x 0.8	10	15.1	48	$12^{+0.05}_0$

Symbol

-X51

2 Through-holes in Opening/Closing Direction

Mounting attachments inside the fingers allows a simple configuration. The finger option of the air gripper MHZ series is mounted.

How to Order

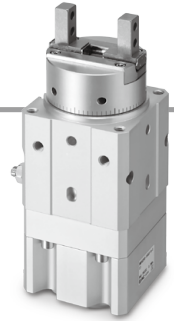
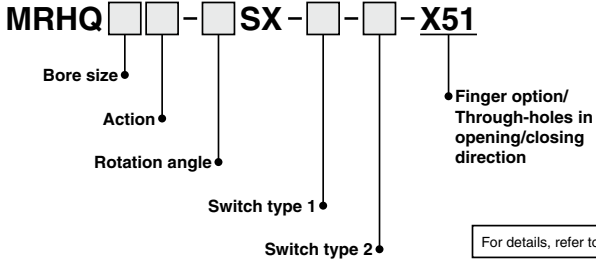

Dimensions (Dimensions other than shown below are the same as standard type.)

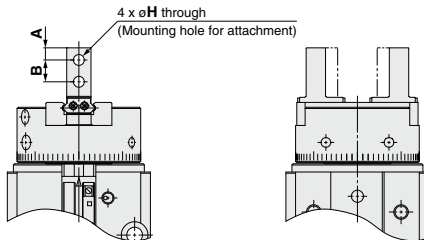

Model	A	B	H
MRHQ10	3	5.7	2.9
MRHQ16	4	7	3.4
MRHQ20	5	9	4.5
MRHQ25	6	12	5.5

[mm]

- MRHZ
- MHF
- MHL
- MHR
- MHK
- MHS
- MHC
- MHT
- MHY
- MHW
- X□
- MRHQ
- MA
- D-□

MRHQ Series

3 Air Gripper with Dust Cover

Symbol

-X111 to X113

Dust cover offers excellent dust proof. Three types of dust cover materials are available. The dust cover is equivalent to the air gripper MHZJ2 series.

How to Order

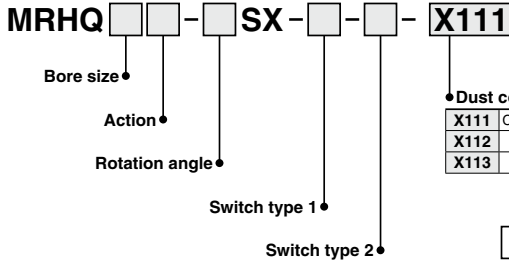

For details, refer to the standard type on page 757.

Dimensions (Dimensions other than shown below are the same as standard type.)

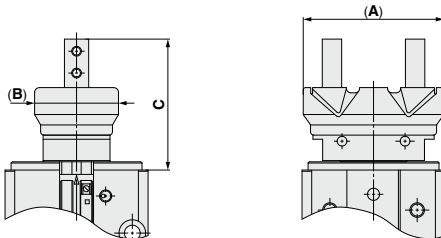

Model	[mm]		
	A	B	C
MRHQ10	34	21	36.5
MRHQ16	45	29.6	44.3
MRHQ20	58	34.6	54
MRHQ25	73	42	66.9



MRHQ Series Specific Product Precautions 1

Be sure to read this before handling the products. Refer to back page 50 for Safety Instructions, pages 4 to 9 for Rotary Actuator Precautions, and pages 366 to 374 for Air Gripper and Auto Switch Precautions.

Selection

⚠ Warning

1. Keep the load energy within the product's allowable energy value.

Operation with a load kinetic energy exceeding the allowable value can cause human injury and/or damage to equipment or machinery. (Refer to "Model Section" procedures in this catalog.)

⚠ Caution

1. When there are load fluctuations, allow a sufficient margin in the actuator torque.

In the case of horizontal mounting (operation with product facing sideways), malfunction may occur due to load fluctuations.

Mounting

⚠ Caution

1. Adjust the rotation angle within the prescribed ranges: $90^\circ \pm 10^\circ$; $180^\circ \pm 10^\circ$ ($\pm 5^\circ$ at end of rotation).

Adjustment outside the prescribed ranges may cause malfunction of the product or failure of switches to operate.

2. Adjust the opening/closing speed of the fingers with a speed controller so that they do not operate any faster than necessary.

When fingers open and close faster than necessary, impact on the fingers and other parts increases, causing poor repeatability when gripping workpieces and danger of an adverse effect on the product's life.

Adjustment of Finger Opening/Closing Speed

Double acting	Install two speed controllers and adjust with meter-out throttling.
Single acting	Install one speed controller and adjust with meter-in throttling. For external gripping – connect to closing port For internal gripping – connect to opening port

3. Adjust the rotation time within the prescribed values using a speed controller. (0.07 to 0.3 s/90°)

Adjustment to a speed slower than 0.3 s/90° can cause sticking and slipping or stopping of operation.

Lubrication

⚠ Caution

1. Use the product without lubrication.

This product is lubricated with grease at the factory, and further lubrication will result in a failure to meet the product's specifications.

Maintenance

⚠ Caution

1. Gripper unit

Replace a gripper unit. When replacing it follow the gripper unit replacement procedures on the next page. Confirm the correct unit part number.

Gripper unit

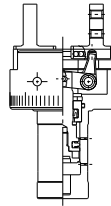

Model	Unit part no.
MRHQ10D	P407090-3D
MRHQ10S	P407090-3S
MRHQ10C	P407090-3C
MRHQ16D	P407060-3D
MRHQ16S	P407060-3S
MRHQ16C	P407060-3C
MRHQ20D	P407080-3D
MRHQ20S	P407080-3S
MRHQ20C	P407080-3C
MRHQ25D	P408080-3D
MRHQ25S	P408080-3S
MRHQ25C	P408080-3C

* A gripper unit includes not only an air gripper, but also three O-rings (12) and three hexagon socket head cap screws (15) as shown in the construction on page 759.

2. Rotary unit

Replace a rotary unit.

Rotary unit

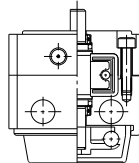

Model	Unit part no.
MRHQ10□- 90S	P406090-2A
MRHQ10□-180S	P406090-2B
MRHQ16□- 90S	P406060-2A
MRHQ16□-180S	P406060-2B
MRHQ20□- 90S	P407080-2A
MRHQ20□-180S	P407080-2B
MRHQ25□- 90S	P408080-2A
MRHQ25□-180S	P408080-2B

* Note that the rotation angle cannot be changed even though the rotary unit has been changed.

For maintenance, order units with a part number suitable for the model being used.

3. O-ring in the body C

(12) O-ring in the construction on page 759: 3 pcs.)

Model	Seal kit part no.
MRHQ10□	MRHQ10S-PS
MRHQ16□	MRHQ16S-PS
MRHQ20□	MRHQ20S-PS
MRHQ25□	MRHQ25S-PS

* Special grease is applied.

* This O-ring is included in the gripper unit.

MHZ

MHF

MHL

MHR

MHH

MHS

MHC

MHT

MHY

MHW

-X□

MRHQ

MA

D-□



MRHQ Series Specific Product Precautions 2

Be sure to read this before handling the products. Refer to back page 50 for Safety Instructions, pages 4 to 9 for Rotary Actuator Precautions, and pages 366 to 374 for Air Gripper and Auto Switch Precautions.

Maintenance

Caution Gripper Unit Replacement Procedure

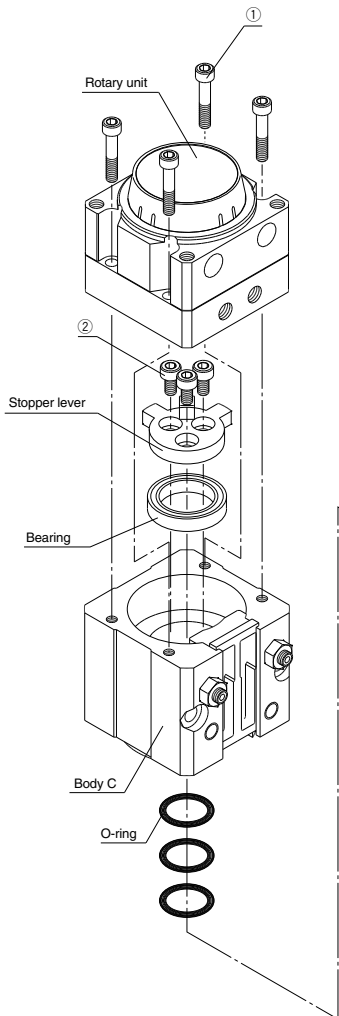

1. Loosen the four bolts ① and remove the rotary unit.
2. Loosen the three bolts ②, remove the stopper lever and pull out the gripper unit.
3. Replace the three O-rings inside body C.
4. Reinstall the two bearings securely in their original positions.
5. Insert a new gripper unit into body C. Then reinstall the stopper lever and parallel pin in their original positions and secure in place by tightening with the three bolts ②.
6. Reinstall the rotary unit in its original position and secure in place by tightening with the four bolts ①.

Model	Tightening torque N·m	
	①	②
MRHQ10	0.9 to 1.2	1.4 to 1.7
MRHQ16	2.5 to 3.0	3.2 to 3.7
MRHQ20	4.5 to 5.0	6.5 to 7.0
MRHQ25	4.5 to 5.0	10.0 to 10.5