

Miniature Regulator

ARJ1020F Series

■ Compact and lightweight (16 g)

■ Low cracking pressure 0.02 MPa
Standard model equipped with backflow function



ARJ1020F-M5-04

ARJ1020F-M5-06

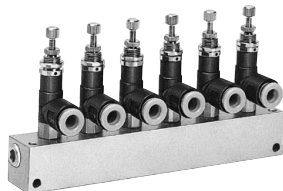

ARJM10-6

Symbol



Note) A standard model is equipped with a backflow function.
A main valve opens when the inlet pressure is released, and then an outlet pressure backflows into the inlet side.

Standard Specifications

Model		ARJ1020F	
Port size	IN side	M5 (Male thread)	
	OUT side (Applicable tubing O.D.)	ø4	ø6
Fluid	Air		
Proof pressure	1.2 MPa		
Maximum operating pressure	0.8 MPa		
Regulating pressure range	Standard: 0.1 to 0.7 MPa		
	0.2 MPa setting 0.05 to 0.2 MPa		
Ambient and fluid temperature	-5 to 60°C (No freezing)		
Construction	Relieving type		
Weight (kg)	0.015	0.016	
Cracking pressure (Valve)	0.02 MPa		
Max. effective area (OUT → IN)	1.8 mm ²		
Applicable tubing material <small>(Note)</small>	Nylon, Soft nylon, Polyurethane		

Note) Be sure to note the maximum operating pressure for soft nylon and polyurethane.
(Refer to Best Pneumatics No. 7.)

Accessory (Option)/Part No.

Description	Part no.
Manifold base	ARJM10-4, -6, -10

How to Order

ARJ 10 20 F - M5 - 04 - □

Miniature regulator

Body size
10 M5

Port size

M5 M5 x 0.8

With One-touch fitting

Piping

20 Elbow type

Semi-standard

Nil	0.7 MPa setting (Standard)
1	0.2 MPa setting

Note) Compared with standard specifications, its adjusting spring has only been changed. It is not the product which does not allow the pressure more than 0.2 MPa. Adjusting spring is not replaceable.

Applicable tubing O.D.

04	4 mm
06	6 mm

Flow Rate Characteristics (Representative values)

Inlet pressure: 0.7 MPa

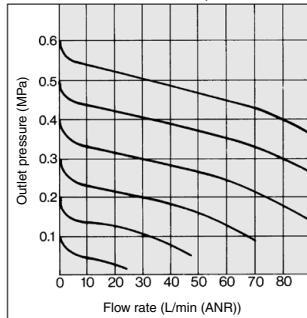

Pressure Characteristics (Representative values)

Conditions (Initial setting)
Inlet pressure: 0.7 MPa
Outlet pressure: 0.2 MPa
Flow rate: 10 L/min (ANR)

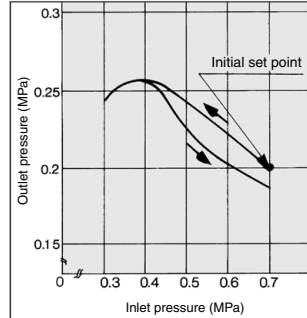

Construction/Dimensions

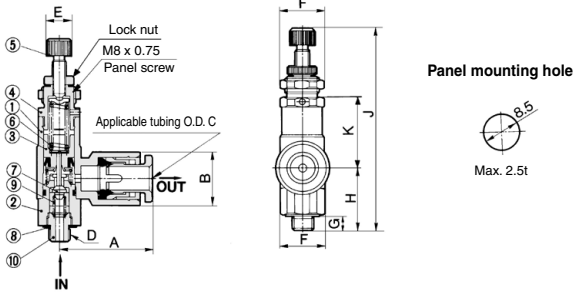

Component Parts

No.	Description	Material	Note
1	Body	PBT	
2	Valve guide	Brass	Electroless nickel plated
3	Piston	Polycetal	
4	Bonnet	Brass	Electroless nickel plated
5	Knob	Brass	Electroless nickel plated
6	Adjusting spring	Steel wire	Zinc chromated
7	Valve	Brass	Rubber lining
10	Nipple	Brass	Electroless nickel plated

Replacement Parts

No.	Description	Material	Part no.
7	Valve	Brass, HNBR	13434-30#1
8	Gasket	Stainless steel	P233014-04
9	Spring	Stainless steel	134313

* When replacing valves and springs, remove nipple first. Note that adhesive is applied to the nipple portion.

Dimensions

Model	A	B	C	D	E	F	G	H	J	K
ARJ1020F-M5-04	21	10.4	4			10.6 (Width across flats: 10)	3.5	15.5	50	17.2
ARJ1020F-M5-06	22	12.8	6	M5 x 0.8	6					

Manifold Base (Option)/Dimensions

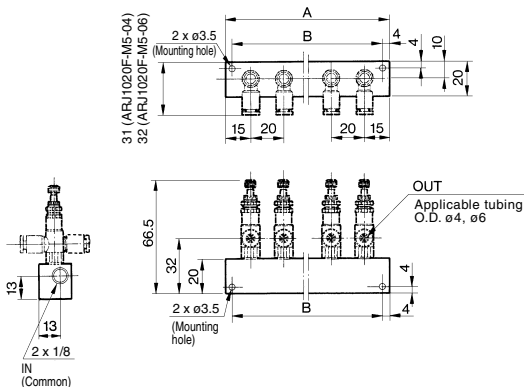

Manifold base part no.	Stations	A dimension	B dimension
ARJM10-4	4	90	82
ARJM10-6	6	130	122
ARJM10-10	10	210	202

⚠ Precautions

Be sure to read this before handling the products. Refer to back page 50 for Safety Instructions and pages 387 to 391 for Precautions on every series.

Piping

⚠ Warning

- To connect the IN side, hold the valve guide at its wrench flats (opposite side 10) and tighten it at the recommended torque of 1.0 to 1.5 N·m. (The recommended torque when using a tightening tool to tighten an additional 1/6 to 1/4 turn after tightening by hand) Excessive torque or holding it at an area other than the specified portion may result in a malfunction.
- While piping to products or operating the knob, ensure that an excess bending moment should not be applied to a product, because it may result in damage.

Mounting/Adjustment

⚠ Warning

- Set up the regulator while verifying the pressure that is indicated on the inlet and the outlet pressure gauges. Turning the knob excessively could damage the internal parts.

⚠ Caution

- Release the lock to adjust the pressure. After the adjustment, engage the lock. Failure to observe this procedure could damage the knob or cause the outlet pressure to fluctuate.
<Lock operating method>
Loosen the lock nut to unlock it, and tighten it to lock it.
- This product can be used as a check regulator by installing it between solenoid valve and actuator.

Selection

⚠ Caution

- When operating at an inlet pressure lower than the inlet pressure used in the flow rate characteristics graph, the pressure drop on the outlet side may be greater. Therefore, be sure to conduct testing using the actual equipment.

For pressure control equipment selection, refer to page 123 in the "Product Selection Guide."

Miniature Regulator

ARJ210 Series

- Lightweight body made of aluminum (60 g)
- Two types of piping connections provided for the IN side: 1/8 (male thread) and M5 (female thread)



ARJ210-M5



ARJ210-M5BG

Symbol



Standard Specifications

Model		ARJ210-M5
Port size	IN side	1/8 (Male thread), M5 x 0.8 (Female thread)
	OUT side	M5 x 0.8 (Female thread 2 pcs.)
Fluid		Air
Proof pressure		1.2 MPa
Maximum operating pressure		0.8 MPa
Regulating pressure range		Standard: 0.2 to 0.7 MPa
		0.2 MPa setting 0.05 to 0.2 MPa
Pressure gauge port size		M5 x 0.8 (Female thread)
Ambient and fluid temperature		-5 to 60°C (No freezing)
Construction		Relieving type
Weight (kg)		0.06

Accessory (Option)/Part No.

Bracket	134856
Pressure gauge ^{Note}	G27-10-R1

Note) When ordering the pressure gauge, a socket assembly (134828A) is required. When installing a pressure gauge, the socket assembly must be fixed and installed to prevent the thread from breaking. 0.2 MPa specification is not available for G27.

How to Order

ARJ 2 10 - M5 BG - [] - []

- ARJ**: Miniature regulator
- 2**: Body size
- 10**: Model (Relieving type (Standard))
- M5**: Port size (IN: 1/8 (Male thread), OUT: M5 x 0.8 (Female thread))
- BG**: Accessory (Note) (B: With bracket, G: With pressure gauge)
- []**: Made to Order (Nil: None (Standard), X209: With backflow function)
- []**: Semi-standard (Nil: 0.7 MPa setting (Standard), 1: 0.2 MPa setting, S: With seal)

Note 1) Compared with standard specifications, its adjusting spring has only been changed. It is not the product which does not allow the pressure more than 0.2 MPa. Adjusting spring is not replaceable.

Note) Backflow function is not available for standard. X209 is with backflow function. A main valve opens when the inlet pressure is released, and then an outlet pressure backflows into the inlet side. X209 is a product with pressure gauge (G27-10-M-X202). The symbol "G" for accessory is not necessary.

Flow Rate Characteristics (Representative values)

Inlet pressure: 0.7 MPa

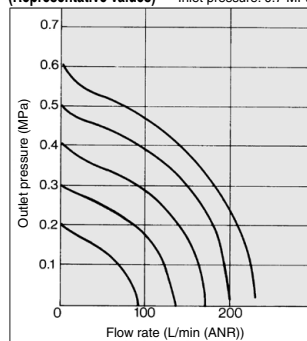

Pressure Characteristics (Representative values)

Conditions (Initial setting)
Inlet pressure: 0.7 MPa
Outlet pressure: 0.2 MPa
Flow rate: 20 L/min (ANR)

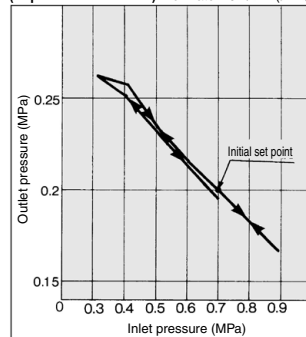

Construction/Dimensions

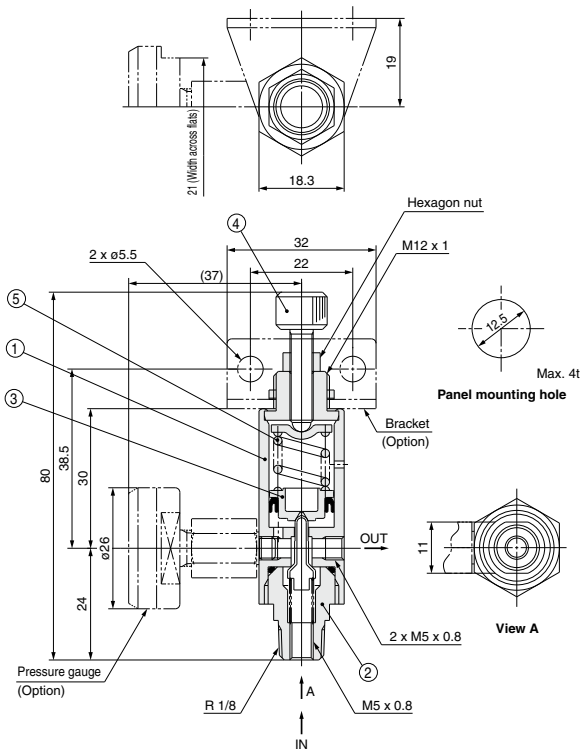

No.	Description	Material	Note
1	Body	Aluminum alloy	Black anodized
2	Valve guide	Brass	Electroless nickel plated
3	Piston	POM	
4	Adjusting screw	Iron	Nickel plated
5	Adjusting spring	Steel wire	Zinc chromated

⚠ Precautions

Be sure to read this before handling the products. Refer to back page 50 for Safety Instructions and pages 387 to 391 for Precautions on every series.

Selection

⚠ Warning

- This product cannot be used as a check regulator by installing it between solenoid valve and actuator. Doing so could lead to equipment damage.
- When piping, tighten the regulator with the recommended proper tightening torque shown in the table below while holding the wrench flats (width 11) of the valve guide for IN port and holding the hexagonal section of the body for the OUT port. Excessive torque or holding it other than at the specified area could lead to equipment damage.
- While piping to products or operating the knob, ensure that an excessbending moment should not be applied to a product, because it may result in damage.

Recommended proper torque

Connection thread	Recommended proper torque [N·m]	Note
M5	1.0 to 1.5	The recommended torque when using a tightening tool to tighten an additional 1/6 to 1/4 turn after tightening by hand.
R1/8	7 to 9	—

⚠ Caution

- When operating at an inlet pressure lower than the inlet pressure used in the flow rate characteristics graph, the pressure drop on the outlet side may be greater. Therefore, be sure to conduct testing using the actual equipment. For pressure control equipment selection, refer to page 123 in the "Product Selection Guide."

Mounting/Adjustment

⚠ Warning

- Set up the regulator while verifying the pressure that is indicated on the inlet and the outlet pressure gauges. Turning the knob excessively could damage the internal parts.

⚠ Caution

- Release the lock to adjust the pressure. After the adjustment, engage the lock. Failure to observe this procedure could damage the knob or cause the outlet pressure to fluctuate.
<Lock operating method>
Loosen the lock nut to unlock it, and tighten it to lock it.
- This product cannot be used as a check regulator by installing it between solenoid valve and actuator. (Except X209)
- Port with a pressure gauge or a plug can be used as an OUT port.

Maintenance

⚠ Warning

- Make sure to perform a periodic inspection of the pressure gauge when the miniature regulator is installed between a solenoid valve and an actuator. Sudden pressure changes could happen and the durability of the product could be reduced. Using an electronic type pressure gauge is recommended, depending on the situation.