

3 Port Solenoid Valve

VT307 Series

Direct Operated Poppet Type



Power consumption

Standard type
4 W

(Current product: 4.8 W)

Energy-saving type
1.8 W

(Current product: 2 W)

Vacuum applications

-101.2
kPa

A single valve with various valve functions

(Universal porting type)

N.C. valve	N.O. valve	
Divider valve	Selector valve	etc.

Low concentration ozone resistant

Rubber seal material: HNBR for main valve

Mounting dimensions are **interchangeable** with current product



Body ported type



Manifold type

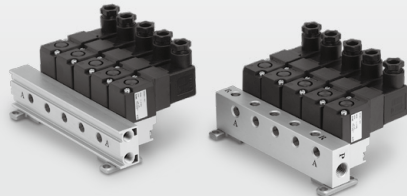

VV061

VV100

V100

S070

VQD

VQD-V

VK

VT



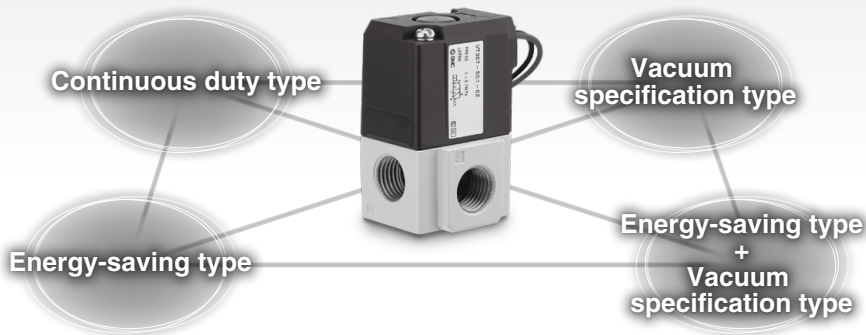

■ A variety of valve options

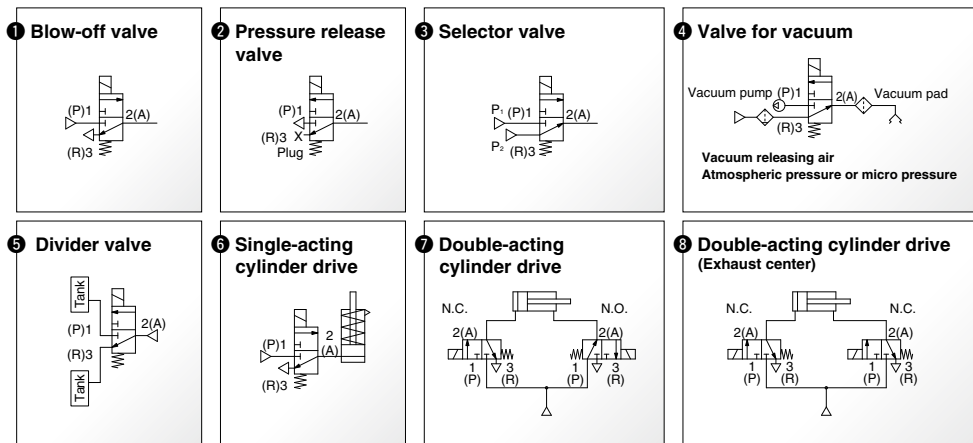

■ Application examples



3 Port Solenoid Valve, Universal Porting Type Variations

Poppet type	Direct operated poppet type			Pilot poppet type
Series	 VT307	 VT317	 VT325	 VP300/500/700
Cv (P→A)	0.19	0.62	1.4	0.8 to 3.6
Page	Page 1433	Page 1441	Page 1449	Page 1261

3 Port Solenoid Valve Direct Operated Poppet Type VT307 Series



Rubber Seal

[Option]
Note) CE compliant: Electrical entry is applicable only for the DIN terminal.

How to Order



V T 307 [] [] - 5 G [] 1 - 01 [] - F - []

Body type

T	Body ported
O	For manifold

Valve option

Nil	Standard type
E*	Continuous duty type
Y*	Energy-saving type
V*	Vacuum specification type
W*	Energy-saving type, Vacuum specification type

* Semi-standard

Pressure specifications

Nil	Standard type (0.7 MPa)
K*	High-pressure type (1 MPa)

* Semi-standard

Rated voltage

Rated voltage	Valve option				
	Nil	E	Y	V	W
1	100 VAC, 50/60 Hz	●	●	—	—
2	200 VAC, 50/60 Hz	●	●	—	—
3*	110 VAC, 50/60 Hz	●	●	—	—
4*	220 VAC, 50/60 Hz	●	●	—	—
5	24 VDC	●	●	●	●
6*	12 DCV	●	●	●	●
7*	240 VAC, 50/60 Hz	●	●	—	—

* Semi-standard

Electrical entry

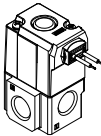
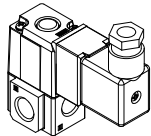
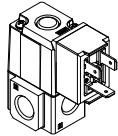
Grommet	DIN terminal
 <p>G: 300 mm lead wire H: 600 mm lead wire</p>	 <p>D: With connector</p>  <p>DO: Without connector</p>

CE-compliant

Nil	None
Q	CE-compliant*

* Electrical entry and light/surge voltage suppressor: D/DO/DZ/DOZ only

Bracket

Nil	None
F	With bracket

Thread type

Nil	Rc
F	G
N	NPT
T	NPTF

Port size

Nil	Without port (For manifold)
01	1/8 (6A)
02	1/4 (8A)

Light/Surge voltage suppressor

Nil	None
S	With surge voltage suppressor (Grommet type only)
Z	With light/surge voltage suppressor (DIN terminal type only)

With surge voltage suppressor

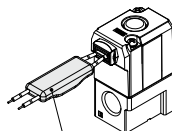

Surge voltage suppressor

Symbol

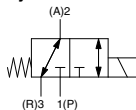

Manifold

Model	Applicable manifold type	Accessories
VO307□(-Q)	Common or individual exhaust	Function plate (DXT152-14-1A) (Note) Mounting screw (NXT013-3)

Note) It is not applicable to the continuous duty type. Refer to the accessories on page 1437.

Option

Description	Part no.
Bracket	DXT152-25-1A (With screw)

VV061

VV100

V100

S070

VQD

VQD-V

VK

VT

⚠ Caution

Make sure that dust and/or other foreign materials do not enter the valve from the unused port (e.g. exhaust port).

Standard Specifications

Type of actuation		Direct operated type 2 position single solenoid
Fluid		Air
Operating pressure range		0 to 1 MPa (High-pressure type), 0 to 0.7 MPa (Standard type)
Ambient and fluid temperature		-10 to 50°C (No freezing)
Response time ^{Note 1)}		20 ms or less (at 0.5 MPa)
Max. operating frequency		10 Hz
Lubrication		Not required (Use turbine oil Class 1 ISO VG32, if lubricated.)
Manual override		Non-locking push type
Mounting orientation		Unrestricted
Impact/Vibration resistance ^{Note 2)}		150/50 m/s ²
Enclosure		Dustproof
Electrical entry		Grommet, DIN terminal
Coil rated voltage (V)	AC (50/60 Hz)	100, 200, 110*, 220*, 240*
	DC	24, 12*
Allowable voltage fluctuation		-15 to +10% of rated voltage
Apparent power ^{Note 3) Note 4)}	AC	12.7 VA (50 Hz), 10.7 VA (60 Hz)
	Inrush Holding	7.6 VA (50 Hz), 5.4 VA (60 Hz)
Power consumption ^{Note 3) Note 4)}	DC	Without indicator light: 4 W, With indicator light: 4.2 W
	AC	Varistor, LED
Light/Surge voltage suppressor (DIN terminal type only)	AC	Varistor, LED
	DC	Diode, LED

* Semi-standard

Note 1) Based on dynamic performance test, JIS B 8419: 2010. (Coil temperature: 20°C, at rated voltage, without surge voltage suppressor)

Note 2) Impact resistance: No malfunction occurred when it is tested with a drop tester in the axial direction and at the right angles to the main valve and armature in both energized and de-energized states every once for each condition. (Values at the initial period)

Vibration resistance: No malfunction occurred in a one-sweep test between 45 and 1000 Hz. Test was performed at both energized and de-energized states in the axial direction and at the right angles to the main valve and armature. (Values at the initial period)

Note 3) At rated voltage

Note 4) The value is different for continuous duty type (VT307E), and energy-saving type (VT307Y/W).

Refer to "Valve Options" shown below.

Flow Rate Characteristics/Weight

Valve model	Port size	Flow rate characteristics												Weight	
		1 → 2 (P → A)			2 → 3 (A → R)			3 → 2 (R → A)			2 → 1 (A → P)				
		C [dm ³ /(s·bar)]	b	Cv	C [dm ³ /(s·bar)]	b	Cv	C [dm ³ /(s·bar)]	b	Cv	C [dm ³ /(s·bar)]	b	Cv		
VT307	1/8	0.71	0.35	0.18	0.68	0.27	0.17	0.65	0.36	0.17	0.63	0.35	0.17	0.15 kg	
VT307E (Vacuum spec. type)		0.41	0.26	0.10	0.44	0.35	0.11	0.48	0.27	0.12	0.35	0.33	0.10		
VT307E (Continuous duty type)															
VT307Y (Energy-saving type)															
VT307W (Energy-saving, Vacuum spec. type)	1/4	0.71	0.31	0.19	0.71	0.25	0.17	0.68	0.33	0.17	0.71	0.26	0.18		
VT307E (Vacuum spec. type)		0.49	0.20	0.12	0.44	0.34	0.11	0.48	0.17	0.12	0.46	0.28	0.11		
VT307E (Continuous duty type)															
VT307Y (Energy-saving type)															
VT307W (Energy-saving, Vacuum spec. type)															

Note) Values for a single valve unit. It is not applicable to the manifold. Refer to the manifold specifications on page 1437.

Valve Options

Continuous duty type: VT307E

Exclusive use of VT307E is recommended for continuous duty with long time loading.

⚠ Caution

- This model is for continuous duty, not for high cycle rates. But even in low cycle rates, if energizing the valve more than once a day, please consult with SMC.
- Energizing solenoid should be done at least once in 30 days.

Specifications different from standard are as follows.

Apparent power/AC	Inrush 7.9 VA (50 Hz), 6.2 VA (60 Hz) Holding 5.8 VA (50 Hz), 3.5 VA (60 Hz)
Power consumption/DC	1.8 W, With indicator light: 2 W
Response time ^{Note)}	30 ms or less (at 0.5 MPa)

Note) Refer to Note 1) of the standard specifications.

Energy-saving type: VT307Y (VT307W)

If low power consumption is required for electronic control, "VT307Y(W)" (1.8 W) is recommended.

Specifications different from standard are as follows.

Power consumption/DC	1.8 W, With indicator light: 2 W
Response time ^{Note)}	25 ms or less (at 0.5 MPa)

Note) Refer to Note 1) of the standard specifications.

Vacuum spec. type: VT307V (VT307W)

This vacuum model has less air leakage than the standard model under low pressure. It is recommended for vacuum application.

⚠ Caution

Since this valve has slight air leakage, it can not be used for vacuum holding (including positive pressure holding) in the pressure container.

Specifications different from standard are as follows.

Operating pressure range	-101.2 kPa to 0.1 MPa
--------------------------	-----------------------

Construction

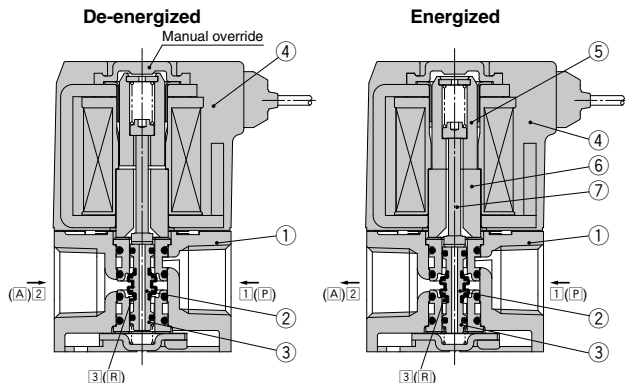

Operation principle

<De-energized>

Poppet valve (2) is pushed upward by the return spring (3), port 1 is closed. Then, port 2 and port 3 are connected.

Air flow direction:

Port 1 ↔ Block, 2 ↔ 3

<Energized>

When energizing the molded coil (4), the armature (5) is magnetically attracted to the core (6), and through the push rod (7), it pushes down the poppet valve (2) and port 3 is closed. Then, port 1 and port 2 are connected. At this time, there will be gaps between the armature (5) and the core (6), but the armature (5) will be magnetically firmly attracted to the core (6).

Air flow direction:

Port 1 ↔ Port 2, Port 3 ↔ Block

Component Parts

No.	Description	Material	Note
1	Body	Aluminum die-casted	Color: White
2	Poppet valve	Aluminum, HNBR	
3	Return spring	Stainless steel	
4	Molded coil	Resin	

How to Use DIN Terminal

1. Disassembly

- After loosening the screw (1), then if the housing (2) is pulled in the direction of the screw (1), the connector will be removed from the body of equipment (solenoid, etc.).
- Pull the screw (1) out of the housing (2).
- On the bottom part of the terminal block (3), there's a cut-off part (9). If a small flat head screwdriver is inserted between the opening in the bottom, terminal block (3) will be removed from the housing (2).
- Remove the cable gland (4), plain washer (5) and rubber seal (6).

2. Wiring

- Pass the cable (7) through the cable gland (4), plain washer (5) and rubber seal (6) in this order, and then insert them into the housing (2).
- Loosen the screw (1) attached to the terminal block (3). Then, pass the lead wire (10) through the terminal block (3) and tighten the screw (1) again.
Note 1) Tighten within the tightening torque of 0.5 N·m ±15%.
Note 2) Cable (7) outside diameter: ø6 to ø8 mm
Note 3) Crimped terminal like round-shape or Y-shape cannot be used.

3. Assembly

- Pass the cable (7) through the cable gland (4), plain washer (5) and rubber seal (6) in this order and connect to the terminal block (3). Then, mount the terminal block (3) on the housing (2). (Push it down until you hear the click sound.)
- Put the rubber seal (6) and plain washer (5) in this order into the cable entry of the housing (2), and then tighten the cable gland (4) securely.
- Insert the gasket (8) between the bottom part of terminal block (3) and the plug attached to the equipment. Then, screw in (1) from the top of the housing (2) to tighten it.
Note 1) Tighten within the tightening torque of 0.5 N·m ±20%.

Changing the entry direction

The orientation of a connector can be changed 180°, depending on the combination of a housing (2) and a terminal block (3).

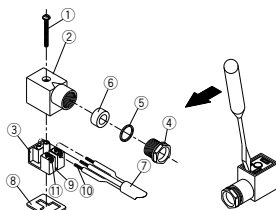

Connector for DIN Terminal

Description	Part no.
DIN connector	B1B09-2A (Standard)
	GM209NJ-B17 (CE-compliant)

Caution

Light/Surge Voltage Suppressor

AC

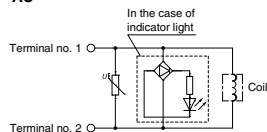

DC

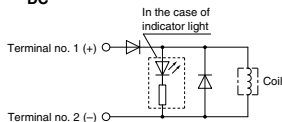

Electrical Connection

DIN terminal is connected inside as in the figure below. Connect to the corresponding power supply.

DIN terminal block

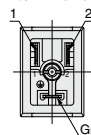

Terminal no.	1	2
DIN terminal	+	-

· Applicable cable O.D.
ø6 to ø8

Lead Wire Color

Voltage	Color
100 VAC	Blue
200 VAC	Red
DC	Red (+), Black (-)
Others	Gray

VV061

VV100

V100

S070

VQD

VQD-V

VK

VT

VT307 Series

Dimensions

Grommet: VT307-□G1

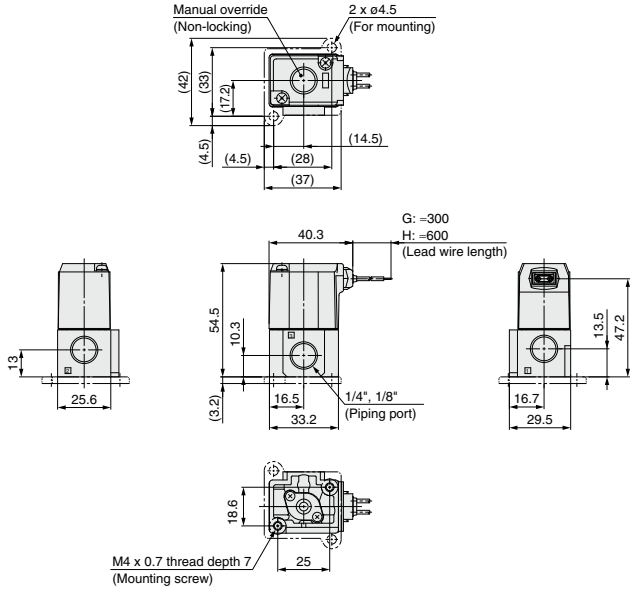

Note) There is also "VT307-□H1" (lead wire length: 600 mm).

DIN terminal: VT307-□D1

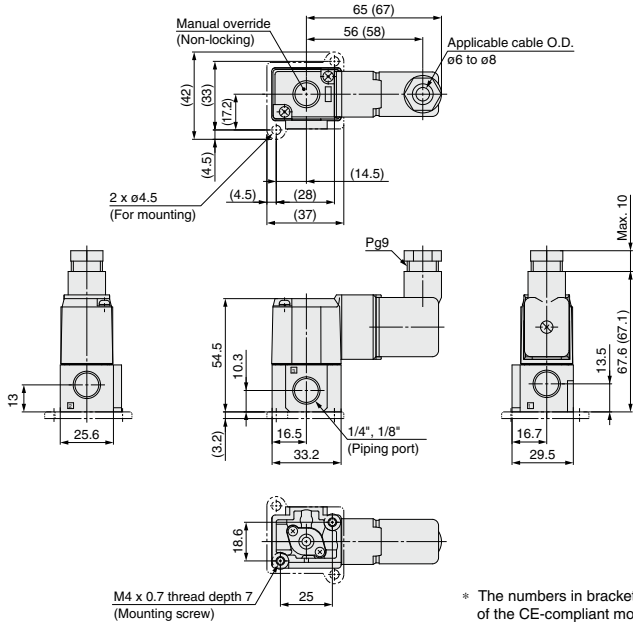

* The numbers in brackets indicate the dimensions of the CE-compliant model (-Q).

VT307 Series

Manifold Specifications

VT307 manifold is available both as a common exhaust and individual exhaust model.

Manifold valve can be easily converted from N.C. (Normally Closed) to N.O. (Normally Open) merely by turning over the function plate.

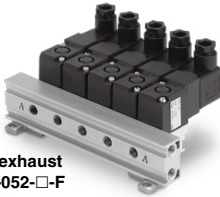

Common exhaust
VV307-01-052-□-F

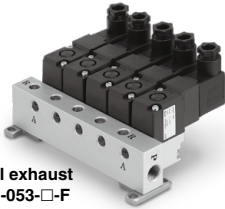

Individual exhaust
VV307-01-053-□-F

How to Order Manifold Base

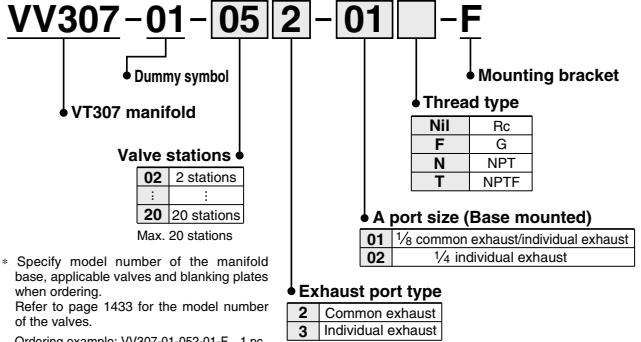

* Specify model number of the manifold base, applicable valves and blanking plates when ordering. Refer to page 1433 for the model number of the valves.

Ordering example: VV307-01-052-01-F... 1 pc.
(5 station manifolds base)
VO307-1G1.....4 pcs.
DXT060-51-13A.....1 pc.
(Blanking plate)

Manifold Specifications

Manifold type	B mount			
Max. number of stations	20 stations ^{Note)}			
Applicable solenoid valve	VO307□-□□□□ (-Q)			
Exhaust port		Port location (Direction)/Port size		
Symbol	Type	P	A	R
2	Common	Base (Side)	Base (Side)	Base (Side)
		1/8	1/8	1/8
3	Individual	Base (Side)	Base (Side)	Base (Top)
		1/4	1/8, 1/4	1/8

Note) For 6 stations or more, supply air both sides of P port. The common exhaust type should exhaust from both of the R port.

Option

Description	Part no.
Blanking plate (With gasket, screw) ^{Note)}	DXT060-51-13 ^A

Accessories for Applicable Solenoid Valve

Description	Part no.	Qty.
Function plate (With gasket) ^{Note)}	DXT152-14-1 ^A	1 pc.
Mounting screws	NXT013-3	2 pcs.

Note) DXT060-51-13B, DXT152-14-1B are for the continuous duty type.

Flow Rate Characteristics/Weight

Valve model	Flow rate characteristics												Weight Grommet
	1 → 2 (P → A)			2 → 3 (A → R)			3 → 2 (R → A)			2 → 1 (A → P)			
	C [dm ³ /(s·bar)]	b	Cv	C [dm ³ /(s·bar)]	b	Cv	C [dm ³ /(s·bar)]	b	Cv	C [dm ³ /(s·bar)]	b	Cv	
VO307	0.34	0.28	0.089	0.34	0.22	0.082	0.36	0.28	0.091	0.34	0.18	0.080	0.15 kg
VO307V (Vacuum spec. type)													
VO307E (Continuous duty type)													
VO307Y (Energy-saving type)													
VO307W (Energy-saving, Vacuum spec. type)	0.30	0.18	0.070	0.30	0.15	0.072	0.32	0.20	0.075	0.30	0.15	0.069	

VO061

VV100

V100

S070

VQD

VQD-V

VK

VT

VT307 Series

Dimensions: Common Exhaust

VV307-01-□2-01-F

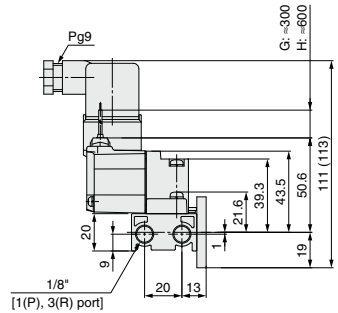
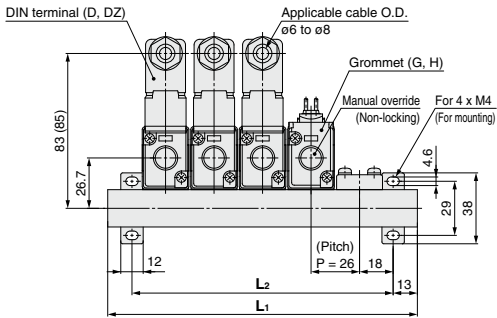
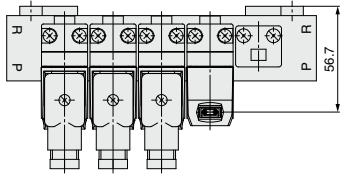

(Station n) (Station 1)

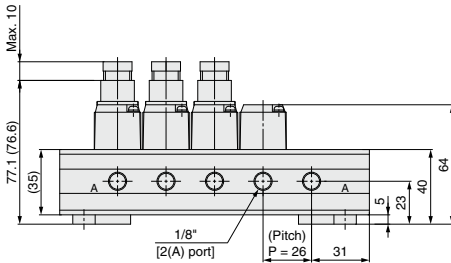

L Dimension

n	2	3	4	5	6	7	8	9	10	n: Stations
L ₁	88	114	140	166	192	218	244	270	296	L ₁ = 26 x n + 36
L ₂	62	88	114	140	166	192	218	244	270	L ₂ = 26 x n + 10

* The numbers in brackets indicate the dimensions of the CE-compliant model (-Q).

Dimensions: Individual Exhaust

VV307-01-□3-□-F

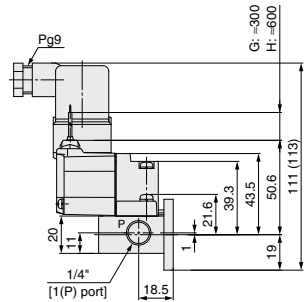
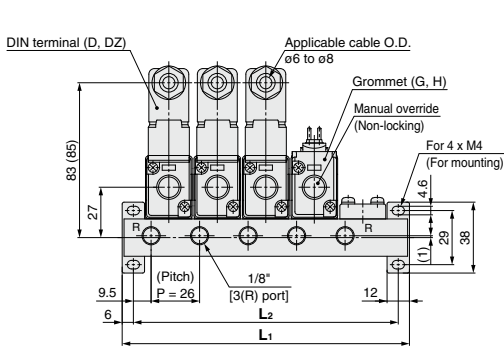
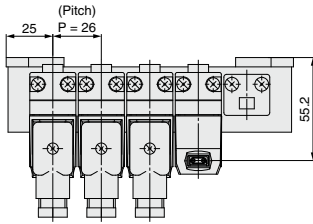

(Station 1) (Station n)

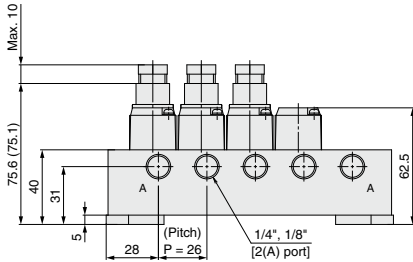

L Dimension

n: Stations

L \ n	2	3	4	5	6	7	8	9	10	Formula
L ₁	76	102	128	154	180	206	232	258	284	L ₁ = 26 x n + 24
L ₂	64	90	116	142	168	194	220	246	272	L ₂ = 26 x n + 12

* The numbers in brackets indicate the dimensions of the CE-compliant model (-Q).

VV061

VV100

V100

S070

VQD

VQD-V

VK

VT

Specific Product Precautions

Be sure to read this before handling the products. Refer to back page 50 for Safety Instructions and pages 3 to 9 for 3/4/5 Port Solenoid Valve Precautions.



Mounting

⚠ Warning

When mounting a valve on the manifold base, N.C. and N.O. can be reversed by the function plate orientation. Also, since the cylinder operates in reverse, confirm if the function plate is correctly mounted or not.

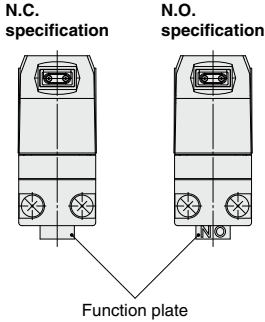

⚠ Caution

1. Each valve is fixed to the manifold base with two M4 mounting screws. Tighten the screws firmly when re-mounting.
2. For mounting, tighten M4 or equivalent screws evenly into the mounting holes of the manifold base.
Tightening torque of the mounting screw (M4): 1.4 N·m

Changing from N.C. to N.O.

⚠ Caution

This product is delivered as N.C. valve.

If N.O. valve is required, remove mounting screws of the required valve and turn over the function plate. (Make sure that there are gaskets on both sides of the plate.) Then, tighten the mounting screws to fix the valve to the manifold base.

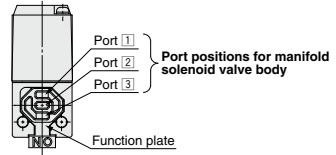

Figure: For N.C.

Specifications	Function plate
N.C.	No mark
N.O.	NO

Piping

⚠ Caution

1. For the common exhaust type, pressurization or evacuation of the 3(R) port can cause a malfunction.