

Peltier-type Chiller

Thermo-con/Rack Mount Type

Air-cooled

Water-cooled



The water-cooled type has been added. (800 W, 1.2 kW)

Reduces the amount of exhaust heat by **90%**
Suppresses rises in the ambient temperature

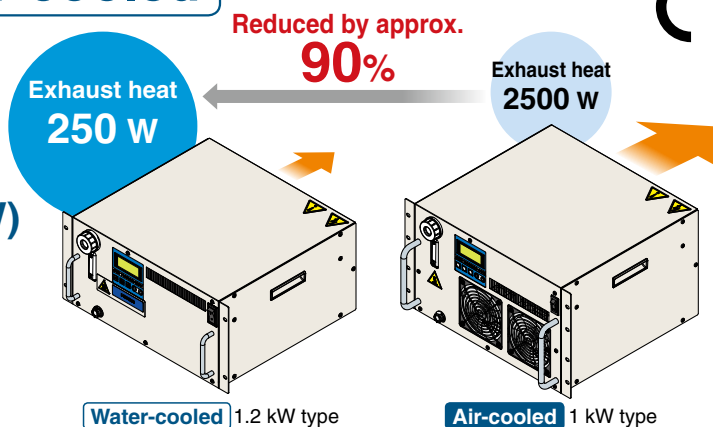

Space-saving design with reduced height

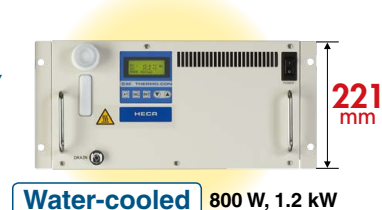
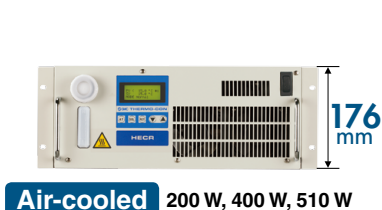

Mountable in a 19-inch rack

Space can be saved by mounting multiple pieces of equipment together in a single rack.

Temperature stability

$\pm 0.01^{\circ}\text{C}$ to 0.03°C

Set temperature range

10°C to 60°C

Cooling capacity

With heating function

200 W, 400 W, 510 W,
800 W, 1 kW, 1.2 kW



HECR Series



CAT.ES40-61D

Can precisely control the temperature of a heat source or process fluid

Precisely control the temperature of the circulating fluid by using the Peltier device. Refrigerant-free and environmentally friendly.



Air-cooled

Water-cooled

▶ Low-noise design

48 dB **Water-cooled**

This product generates less vibration, dust, and noise due to its lack of moving parts, such as a compressor. In particular, the water-cooled type is quieter as it uses no fans. For the air-cooled type (excluding the 200 W) as well, noise is reduced by suppressing the number of fan rotations when the cooling load is low.

Noise level

49 dB	Air-cooled	HECR002
55 dB		HECR004/006*1
54 dB		HECR008/010*2
48 dB	Water-cooled	HECR008/012

*1 200 W load *2 500 W load

▶ Energy-saving design

200 W **Water-cooled**

Power consumption

200 W	Air-cooled	HECR004/006*1
400 W		HECR008/010*2
300 W	Water-cooled	HECR008*2
200 W		HECR012*2

*1 200 W load *2 500 W load

▶ Simple operation

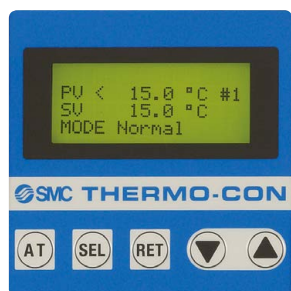

- 1 Turn the power ON.
- 2 Press the **SEL** key, and adjust the temperature setting with the **▼**/**▲** keys.
- 3 Press the **RET** key to complete.

Fluid fill port

Fluid can be supplied without removing the product from the rack.

Rack mounting bracket

A floor type is also available. (Option)

The rack mounting brackets and the handles can be removed and rubber feet can be mounted instead. (Refer to page 21 for details.)



The circulating fluid volume can be checked.

Drain pan

The product comes equipped with a drain pan to avoid any risk of fluid leakage flowing over equipment mounted on lower racks.

▶ Drain port provided on the front (800 W, 1 kW, 1.2 kW type)





Draining the circulating fluid is possible without removing the piping.

The fitting should be provided by the user.



CPC PLCD16004

Variations

	Series	Cooling capacity	Heating capacity	Cooling method	Temperature stability	Power supply	Circulating fluid	Options (p. 21)	International standards
Air-cooled		HECR002-A	200 W	600 W	Peltier-type	±0.01 to 0.03°C	· Tap water · Ethylene glycol 20%	· With feet and no rack mounting brackets · With flow switch · High-pressure pump mounted	
		004-A	400 W	1 kW					
		006-A	510 W	1.2 kW					
		HECR008-A	800 W	1.4 kW					
		010-A	1 kW	2 kW					
Water-cooled		HECR008-W	800 W	1.4 kW	Peltier-type water-cooled	Single-phase 100 to 240 VAC (50/60 Hz)			
		012-W	1.2 kW	2 kW		Single-phase 200 to 240 VAC (50/60 Hz)			

▶ Reduces pump maintenance time (Maintenance-free pump)

A mechanical sealless canned pump is used.

As the circulating fluid of the pump cannot leak externally, checks for pump leakage and maintenance of the shaft seal are not necessary.

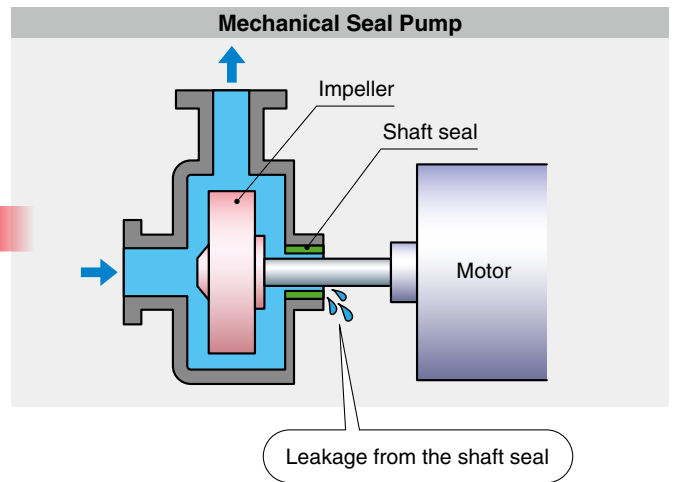
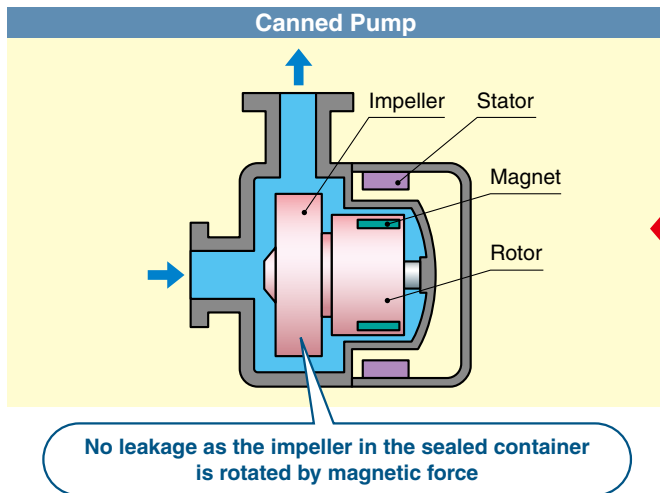

▶ Application example for the water-cooled thermo-con

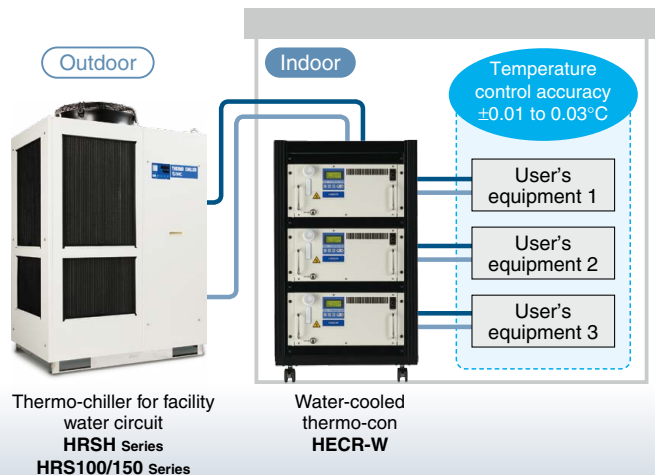

▶ Learning control function (Temperature control by external temperature sensor)

This function adjusts the fluid temperature to the set value with an automatic offset setting. Setting the external temperature sensor at the circulating fluid inlet located just in front of the heat source allows the thermo-con to sample the fluid temperature. This function is effective in automatically adjusting for heat exhaust from piping, etc.

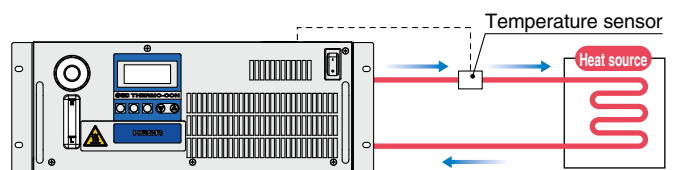

If the external temperature sensor is installed directly on the heat source, the learning control function may not work properly due to a large heat volume or large temperature difference. Be sure to install the sensor at the circulating fluid inlet.

Construction and Principles

Figure 1

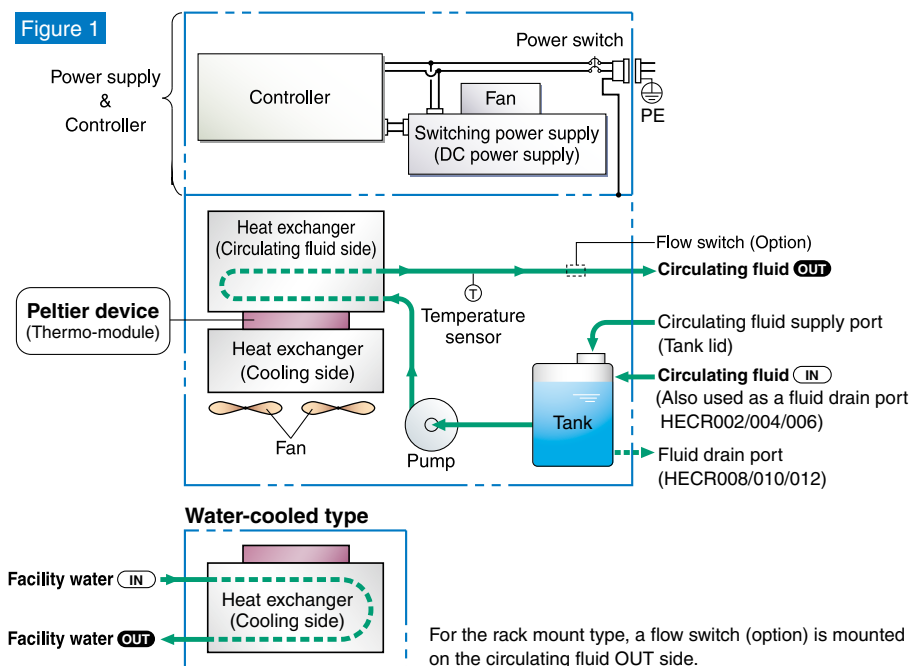
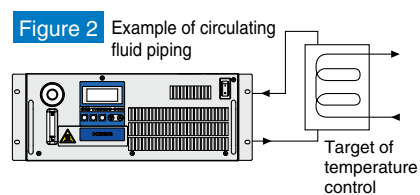

Figure 2



The thermo-con is constructed as shown in Figure 1. It interposes a Peltier device (thermo-module) between the heat exchangers for the circulating fluid and facility water and controls the DC power supply to achieve the target circulating fluid outlet temperature.

The circulating fluid returns to the tank and is transferred by the pump which is built into the thermo-con, then it goes through the heat exchangers and temperature sensor and out from the circulating fluid outlet.

Figure 2 shows an example of circulating fluid piping. The circulating fluid is transferred at a constant temperature by the pump.

Application Examples

Laser machining

Cooling of the laser irradiated part

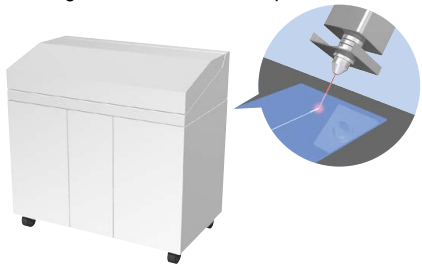

UV curing device

(Printing, painting, bonding and sealing)

Cooling of the UV lamp

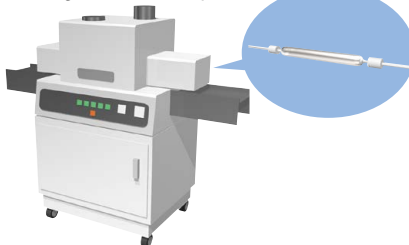

X-ray (digital) instrument

Temperature control of the X-ray tube and X-ray light sensing part

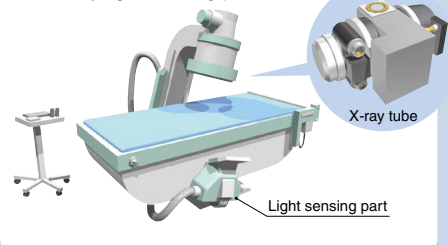

Electronic microscope

Temperature control of the electron-beam irradiated part

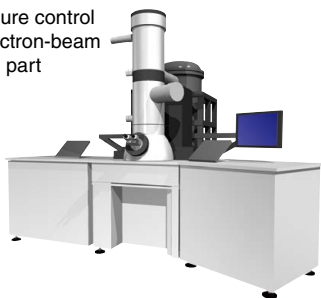

Laser marker

Cooling of the laser irradiated part

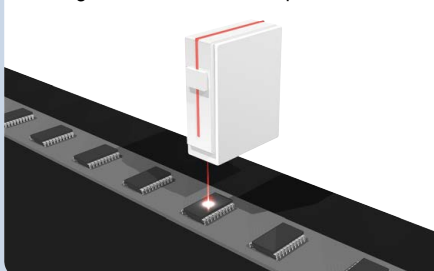

Ultrasonic wave inspection machine

Temperature control of the ultrasonic wave laser part



Laser oscillator

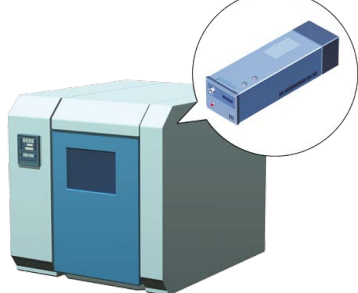

Laser power sensor

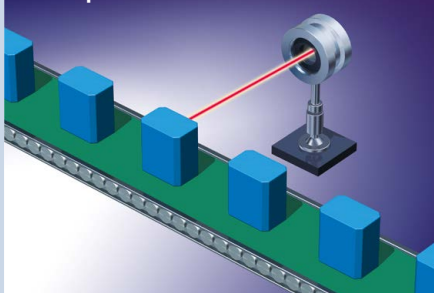

Transmission cable connector for fiber laser

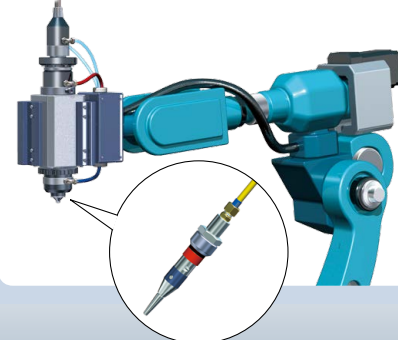

CONTENTS

HECR Series



Model Selection p. 5

Thermo-con/Rack Mount Type

Air-cooled HECR-A Series

How to Order/Specifications p. 7
 Cooling Capacity p. 8
 Heating Capacity p. 9
 Pump Capacity (Thermo-con Outlet) p. 10
 Dimensions p. 12

Thermo-con/Rack Mount Type

Water-cooled HECR-W Series

How to Order/Specifications p. 16
 Cooling Capacity p. 17
 Heating Capacity p. 17
 Pump Capacity (Thermo-con Outlet) p. 18
 Pressure Loss in Facility Water Circuit p. 18
 Dimensions p. 19

Operation Display Panel p. 20
 Alarm p. 20
 Maintenance p. 20

● Options

With Feet and No Rack Mounting Brackets p. 21
 With Flow Switch p. 21
 High-Pressure Pump Mounted p. 21

● Optional Accessories

Power Supply Cable p. 22

Specific Product Precautions p. 23

Model Selection

Air-cooled HECR-A

Water-cooled HECR-W

Options
Optional Accessories

Specific Product
Precautions

HECR Series Model Selection

Guide to Model Selection

1. How much is the temperature in degrees centigrade for the circulating fluid?

Temperature range which can be set with the thermo-con: 10 to 60°C

If a lower temperature (down to -20°C) or higher temperature (up to 90°C) than this range is necessary, select the thermo-chiller HRZ series.

2. What kind of the circulating fluids will be used?

Circulating fluids that can be used in the thermo-con: Tap water, Ethylene glycol 20%

When using fluorinated fluids, select the water-cooled thermo-con HEC series.

3. How much cooling capacity required?

Allows a safety factor of 20% over the capacity that is actually required, taking into account the changes in the operating conditions. If a larger capacity than this thermo-con is necessary, select the Peltier-type thermo-con HEC series (refer to the following.) or the refrigerated thermo-chiller HRS/HRZ series.

Example 1 When the heat generation amount in the user's equipment is known.

Heat generation amount: 400 W

Cooling capacity = Considering a safety factor of 20%,

$$400 \text{ W} \times 1.2 = 480 \text{ W}$$

Thermo-con/HEC Series

High-precision temperature control type for semiconductor manufacturing equipment, medical equipment, etc.

- Cooling capacity: 140 W to 1200 W
- Temperature stability: $\pm 0.01^\circ\text{C}$ to 0.03°C

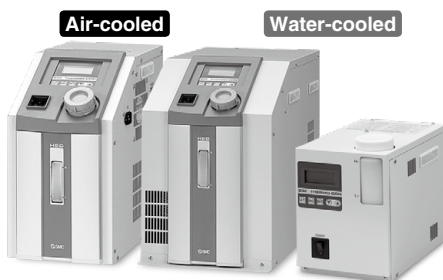

For details, refer to the [Web Catalog](#).

Guide to Model Selection

Example 2 When the heat generation amount in the user's equipment is not known.

Obtain the temperature difference between inlet and outlet by circulating the fluid inside the user's equipment.

Heat generation amount **Q** : Unknown
 Circulating fluid temperature difference $\Delta T (= T_2 - T_1)$: 0.8°C (0.8 K)
 Circulating fluid outlet temperature **T1** : 25°C (298.15 K)
 Circulating fluid return temperature **T2** : 25.8°C (298.95 K)
 Circulating fluid flow rate **L** : 3 L/min
 Circulating fluid : Water
 Density γ : $1 \times 10^3 \text{ kg/m}^3$
 Specific heat **C**: $4.2 \times 10^3 \text{ J/(kg}\cdot\text{K)}$

$$Q = \frac{\Delta T \times L \times \gamma \times C}{60 \times 1000}$$

$$= \frac{0.8 \times 3 \times 1 \times 10^3 \times 4.2 \times 10^3}{60 \times 1000}$$

$$= 167 \text{ W}$$

Cooling capacity = Considering a safety factor of 20%,

$$167 \text{ W} \times 1.2 = \boxed{200 \text{ W}}$$

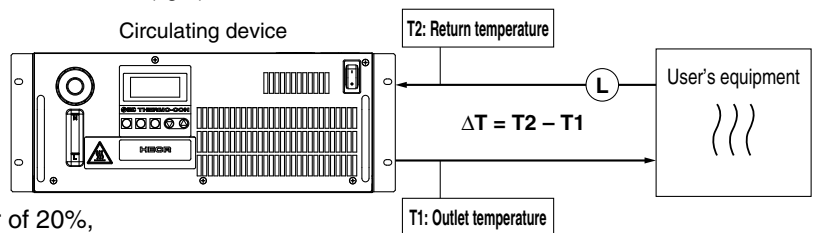

Example 3 When cooling the object below a certain temperature in certain period of time.

Cooled substance total volume **V** : 2 L
 Cooling time **h** : 15 min
 Cooling temperature difference ΔT : Temperature difference: 10°C (10 K). Cool from 30°C (303 K) to 20°C (293 K).
 Circulating fluid : Tap water
 Density γ : $1 \times 10^3 \text{ kg/m}^3$
 Specific heat **C**: $4.2 \times 10^3 \text{ J/(kg}\cdot\text{K)}$

* Refer to the information shown below for the typical physical property values by circulating fluid.

$$Q = \frac{\Delta T \times V \times \gamma \times C}{h \times 60 \times 1000}$$

$$= \frac{10 \times 2 \times 1 \times 10^3 \times 4.2 \times 10^3}{15 \times 60 \times 1000}$$

$$= 93.3 \text{ W}$$

Cooling capacity = Considering a safety factor of 20%,

$$93.3 \text{ W} \times 1.2 = \boxed{112 \text{ W}}$$

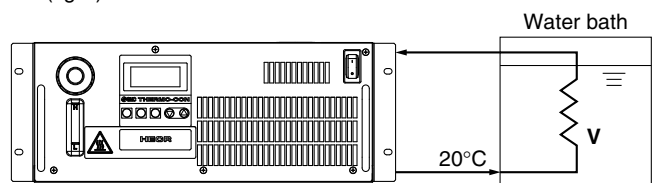

After 15 min, cool 30°C down to 20°C.

Precautions on Model Selection

The flow rate of the circulating fluid depends on the pressure loss of the user's equipment and the length, diameter and resistance created by bends in the circulating fluid piping, etc. Check if the required flow rate of circulating fluid can be obtained before selecting.

Circulating Fluid Typical Physical Property Values

Ethylene Glycol Solution 20%

Temperature [°C]	Density ρ [kg/m ³]	Specific heat C [J/(kg·K)]
10	1.03×10^3	3.93×10^3
20	1.03×10^3	3.95×10^3
30	1.02×10^3	3.97×10^3
40	1.02×10^3	3.98×10^3
50	1.01×10^3	4.00×10^3
60	1.01×10^3	4.02×10^3

Water

Density γ : $1 \times 10^3 \text{ [kg/m}^3\text{]}$

Specific heat **C**: $4.2 \times 10^3 \text{ [J/(kg}\cdot\text{K)]}$

Thermo-con/ Rack Mount Type

HECR Series **Air-cooled**

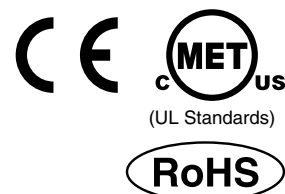

How to Order

HECR **002** - **A** **5** - -

Cooling capacity

002	200 W
004	400 W
006	510 W
008	800 W
010	1 kW

Radiating method

A	Air-cooled
---	------------

Power supply

2	200 to 240 VAC	HECR010
5	100 to 240 VAC	HECR002, 004, 006, 008

Option

Nil	None
E	With feet and no rack mounting brackets
F	With flow switch
P	High-pressure pump mounted

• When multiple options are combined, indicate symbols in alphabetical order.

Pipe thread

Nil	Rc
N	NPT thread

Specifications

Model	HECR002-A	HECR004-A	HECR006-A	HECR008-A	HECR010-A	
Cooling method	Thermoelectric device (Thermo-module)					
Radiating method	Forced air cooling					
Control method	Cooling/Heating automatic shift PID control					
Ambient temperature/humidity	10 to 35°C, 35 to 80% RH (No condensation)					
Circulating fluid system	Circulating fluid	Tap water, Ethylene glycol 20%				
	Set temperature range	10.0 to 60.0°C (No condensation)				
	Cooling capacity	200 W (Tap water)*1	400 W (Tap water)*1	510 W (Tap water)*1	800 W (Tap water)*2	1 kW (Tap water)*2
	Heating capacity	600 W (Tap water)*1	1 kW (Tap water)*1	1.2 kW (Tap water)*1	1.4 kW (Tap water)*2	2 kW (Tap water)*2
	Temperature stability*3	±0.01 to 0.03°C				
	Pump capacity	Refer to the performance charts. (Pages 10 and 11)				
	Tank capacity	Approx. 1.3 L				
	Port size	Rc1/4	Rc3/8			
Fluid contact material	Stainless steel, EPDM, NBR, Ceramics, PPE, Carbon, PP, PE, PPS (High pressure)	Stainless steel, EPDM, NBR, Ceramics, PPE, PPS, Carbon, PP, PE, Nylon, POM (HECR008, 010), PVC (High pressure)				
Electrical system	Power supply	Single-phase 100 to 240 VAC ±10%, 50/60 Hz				Single-phase 200 to 240 VAC ±10%, 50/60 Hz
	Overcurrent protector	10 A	14 A			
	Current consumption	5 A (100 V) to 2.5 A (240 V)	9 A (100 V) to 4 A (240 V)		10 A (100 V) to 4 A (240 V)	8 A (200 V)
	Power consumption	440 W*1	850 W*1		900 W*2	1500 W*2
	Alarm	Refer to "Alarm." (Page 20)				
	Communications	RS-232C/RS-485				
Weight	Approx. 14 kg	Approx. 18 kg	Approx. 21 kg	Approx. 31 kg	Approx. 33 kg	
Accessories	Power supply connector, Operation Manual Power supply cable should be ordered as an option (sold separately, page 22) or prepared by the user.					
Safety standards	CE marking, UL (NRTL) standards					

*1 Conditions: Set temperature 25°C, Ambient temperature 25°C, Circulating flow rate 3 L/min

*2 Conditions: Set temperature 25°C, Ambient temperature 25°C, Circulating flow rate 4 L/min

*3 The indicated values are with a stable load without turbulence in the operating conditions. It may be out of this range in some other operating conditions.

Cooling Capacity

HECR002-A

Circulating fluid: Tap water

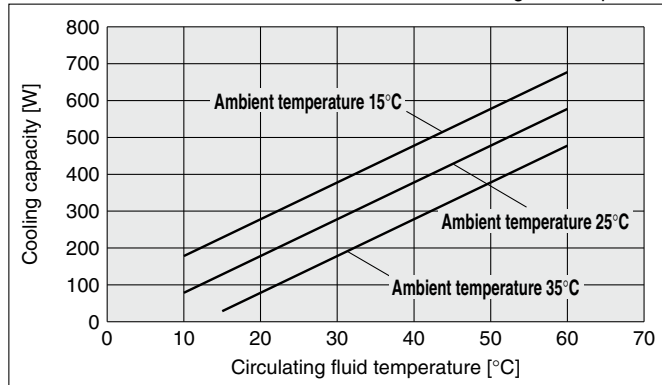

Circulating fluid: Ethylene glycol 20%

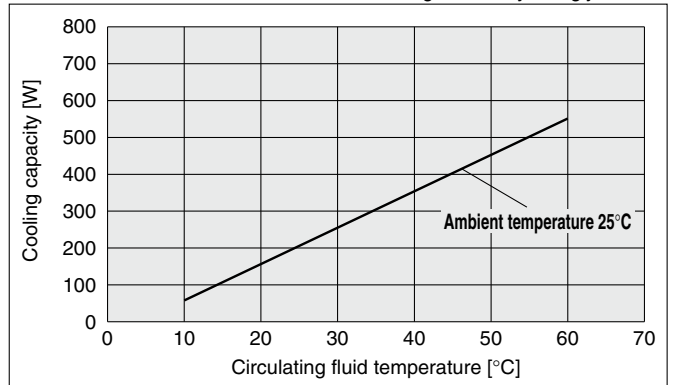

HECR004-A

Circulating fluid: Tap water

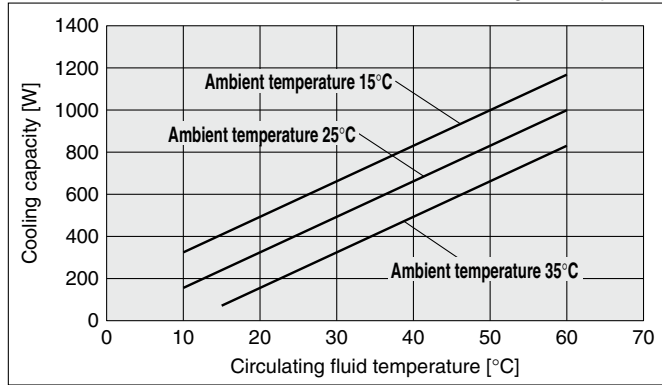

Circulating fluid: Ethylene glycol 20%

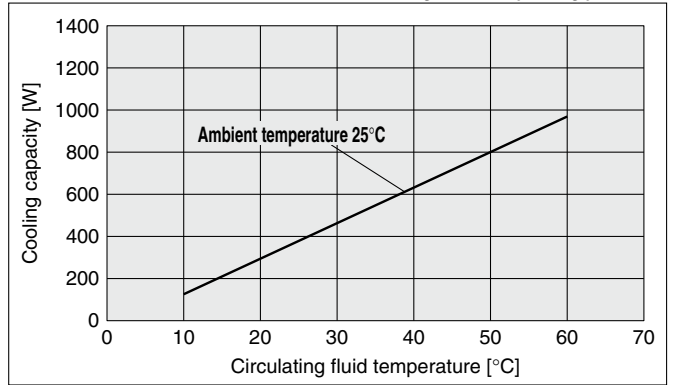

HECR006-A

Circulating fluid: Tap water

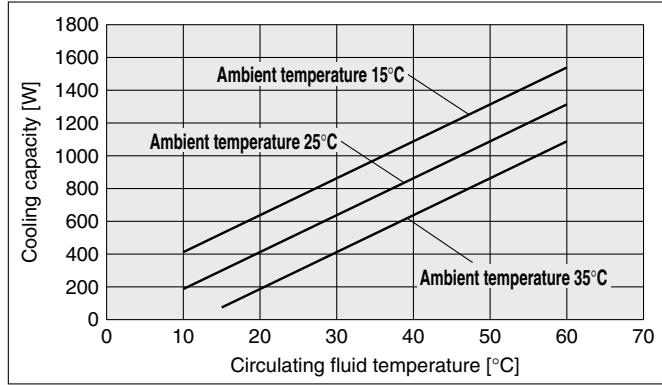

Circulating fluid: Ethylene glycol 20%

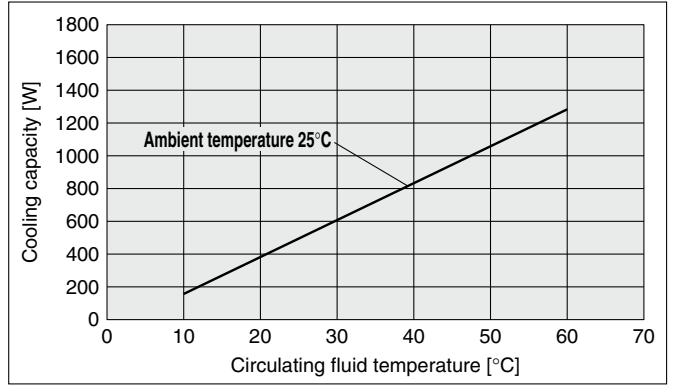

HECR008-A

Circulating fluid: Tap water

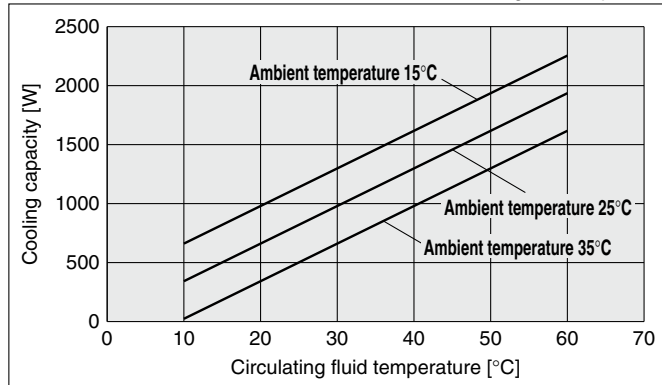

Circulating fluid: Ethylene glycol 20%

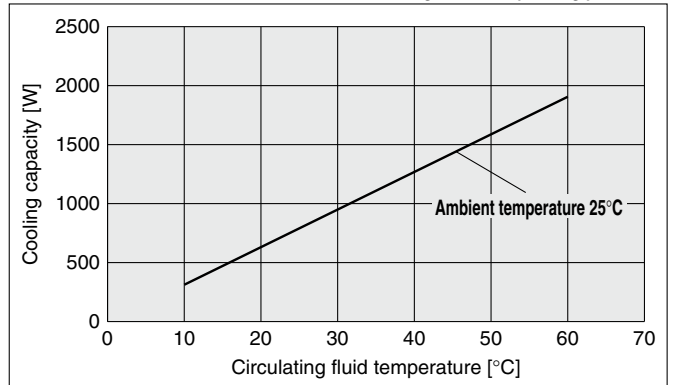

Model Selection

Air-cooled **HECR-A**

Water-cooled **HECR-W**

Options
Optional Accessories

Specific Product
Precautions

HECR Series

Cooling Capacity

HECR010-A

Circulating fluid: Tap water

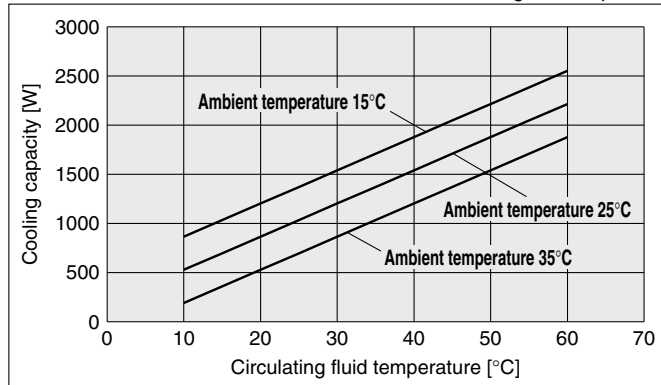

Circulating fluid: Ethylene glycol 20%

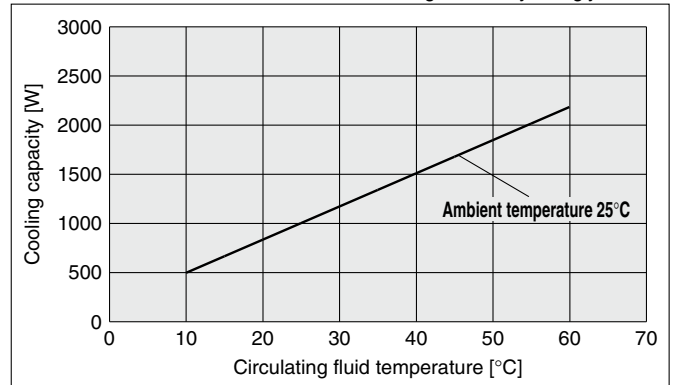

Heating Capacity

HECR002-A

Circulating fluid: Tap water

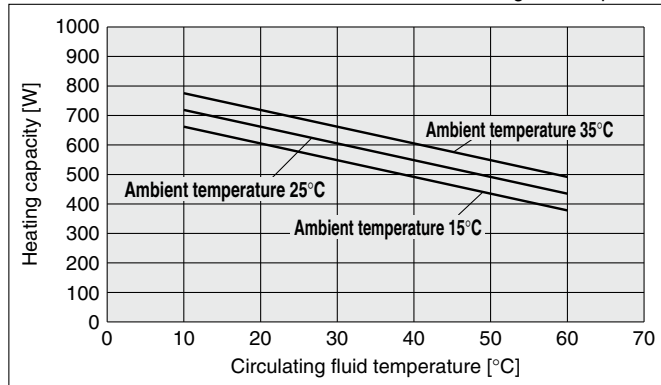

Circulating fluid: Ethylene glycol 20%

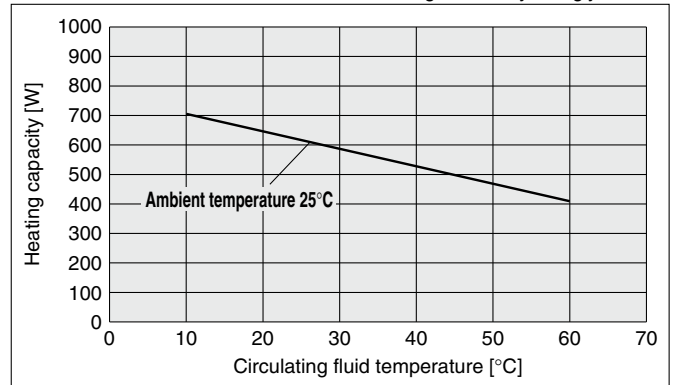

HECR004-A

Circulating fluid: Tap water

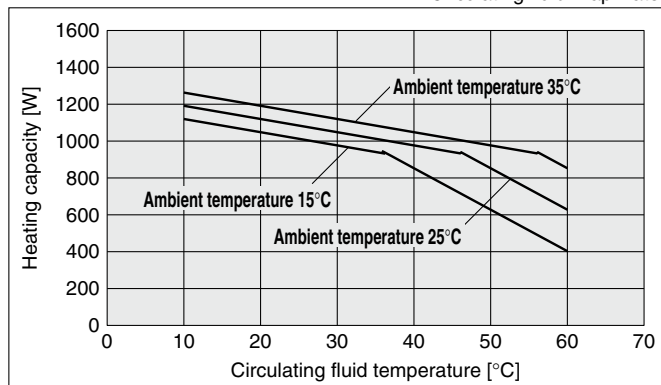

Circulating fluid: Ethylene glycol 20%

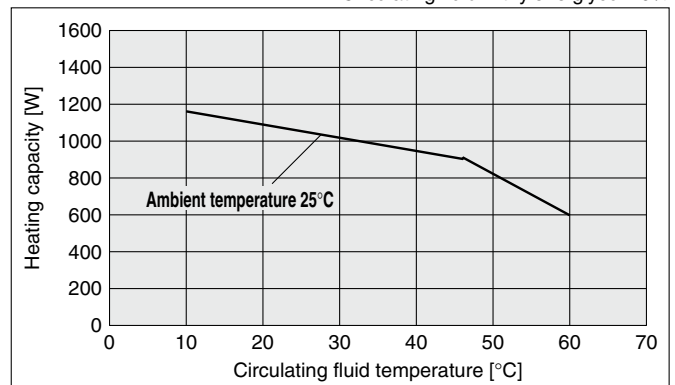

HECR006-A

Circulating fluid: Tap water

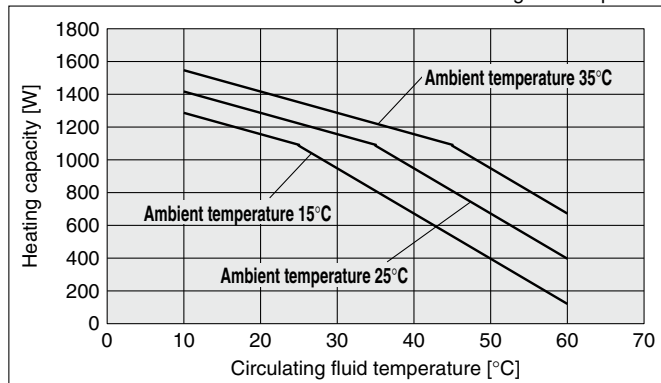

Circulating fluid: Ethylene glycol 20%

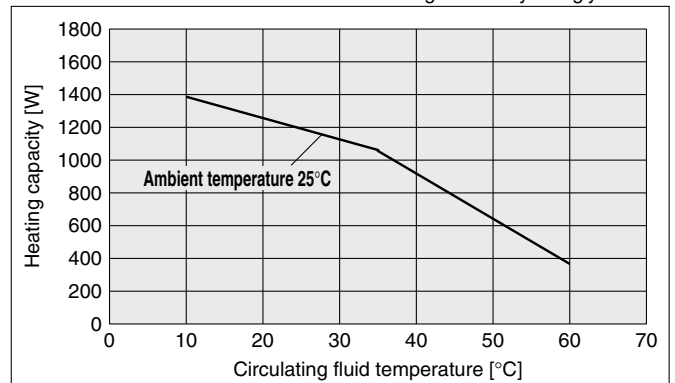

Heating Capacity

HECR008-A

Circulating fluid: Tap water

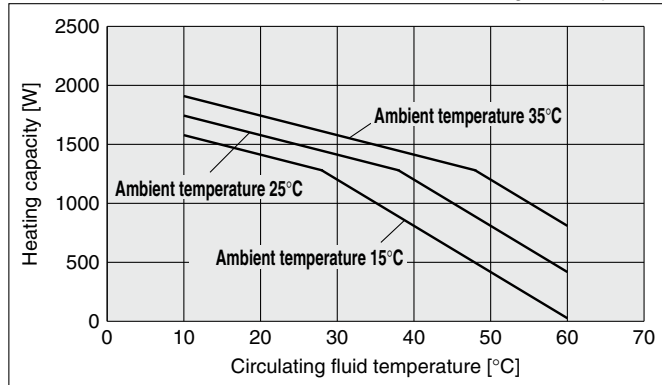

Circulating fluid: Ethylene glycol 20%

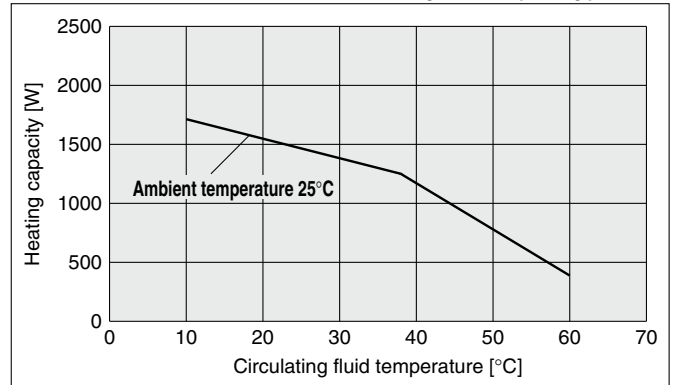

HECR010-A

Circulating fluid: Tap water

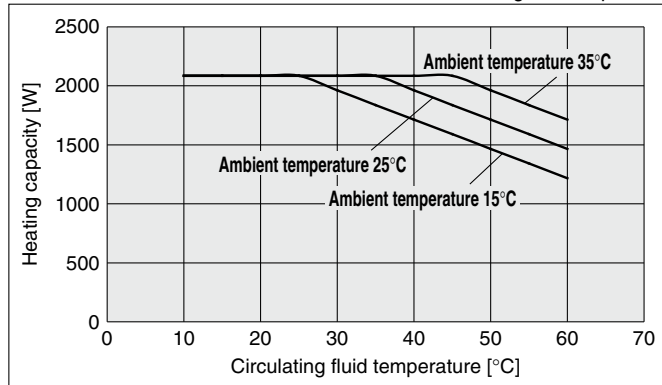

Circulating fluid: Ethylene glycol 20%

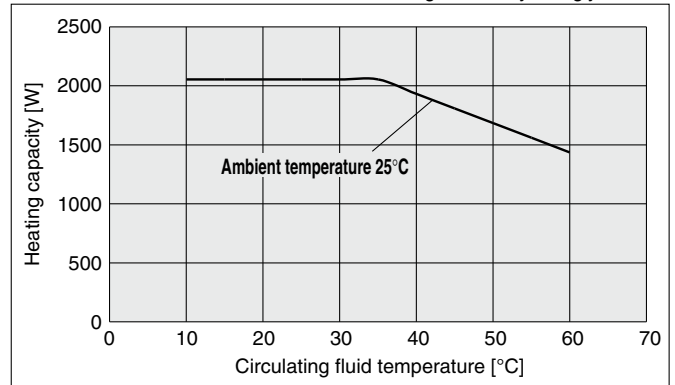

Pump Capacity (Thermo-con Outlet)

HECR002-A

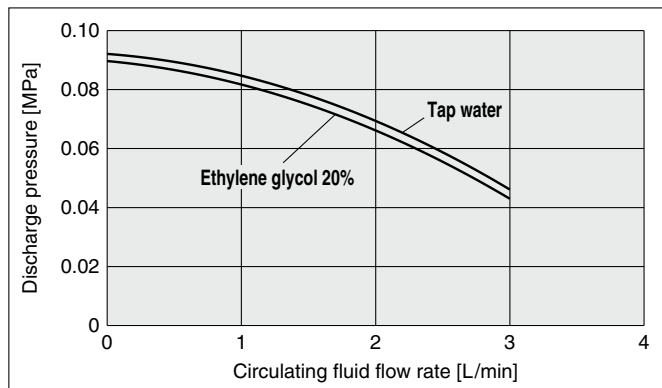

When high-pressure pump mounted

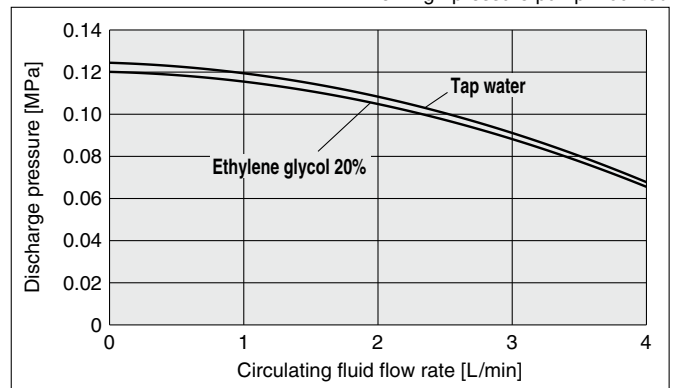

HECR004-A

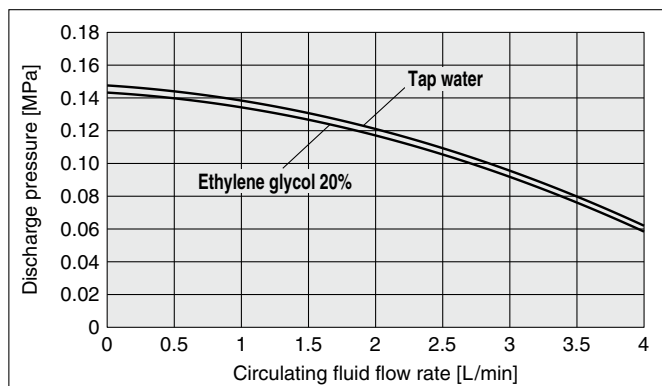

When high-pressure pump mounted

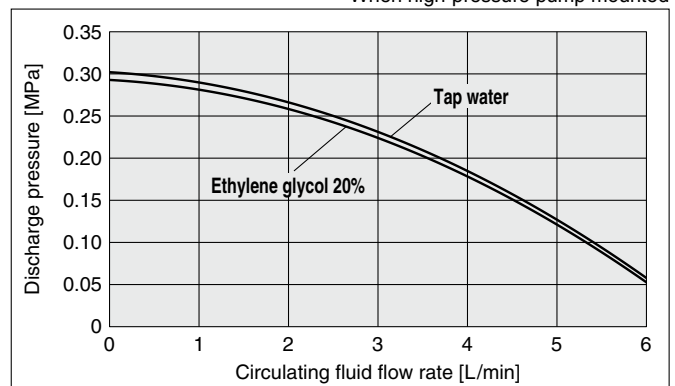

Model Selection

Air-cooled **HECR-A**

Water-cooled **HECR-W**

Options
Optional Accessories

Specific Product
Precautions

HECR Series

Pump Capacity (Thermo-con Outlet)

HECR006-A

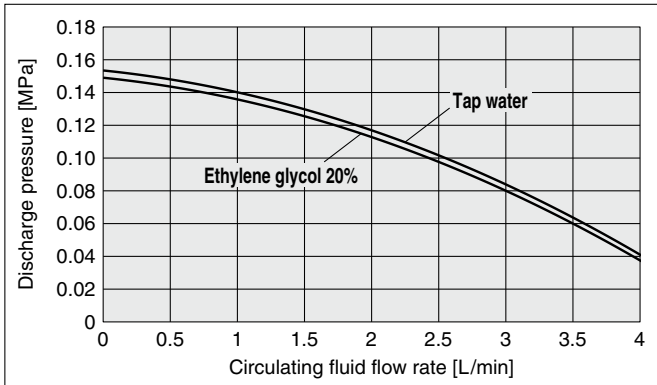

When high-pressure pump mounted

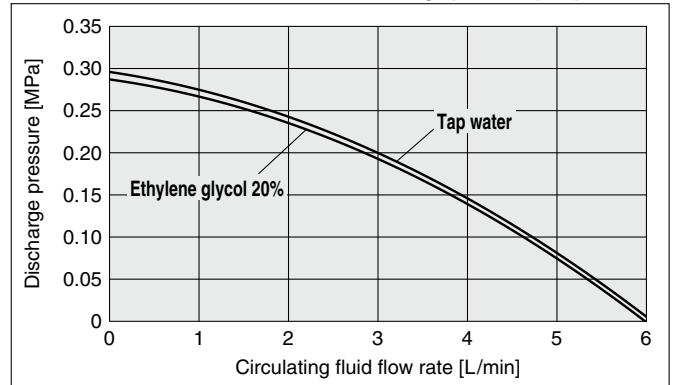

HECR008-A/010-A

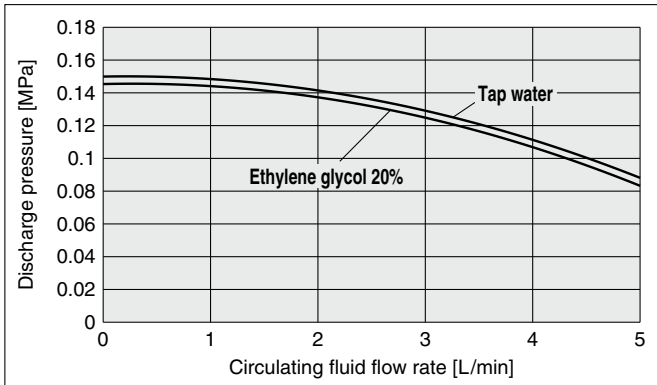

When high-pressure pump mounted

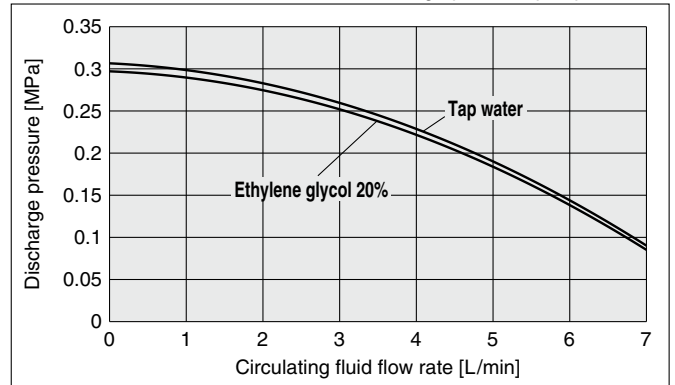

Dimensions

HECR002-A5

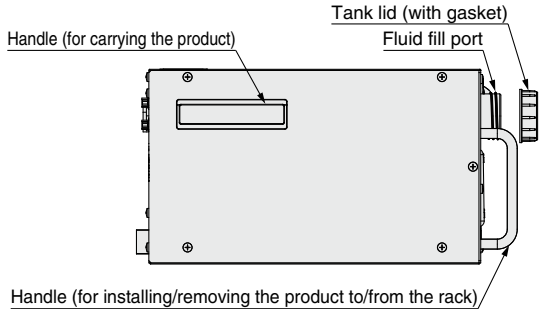
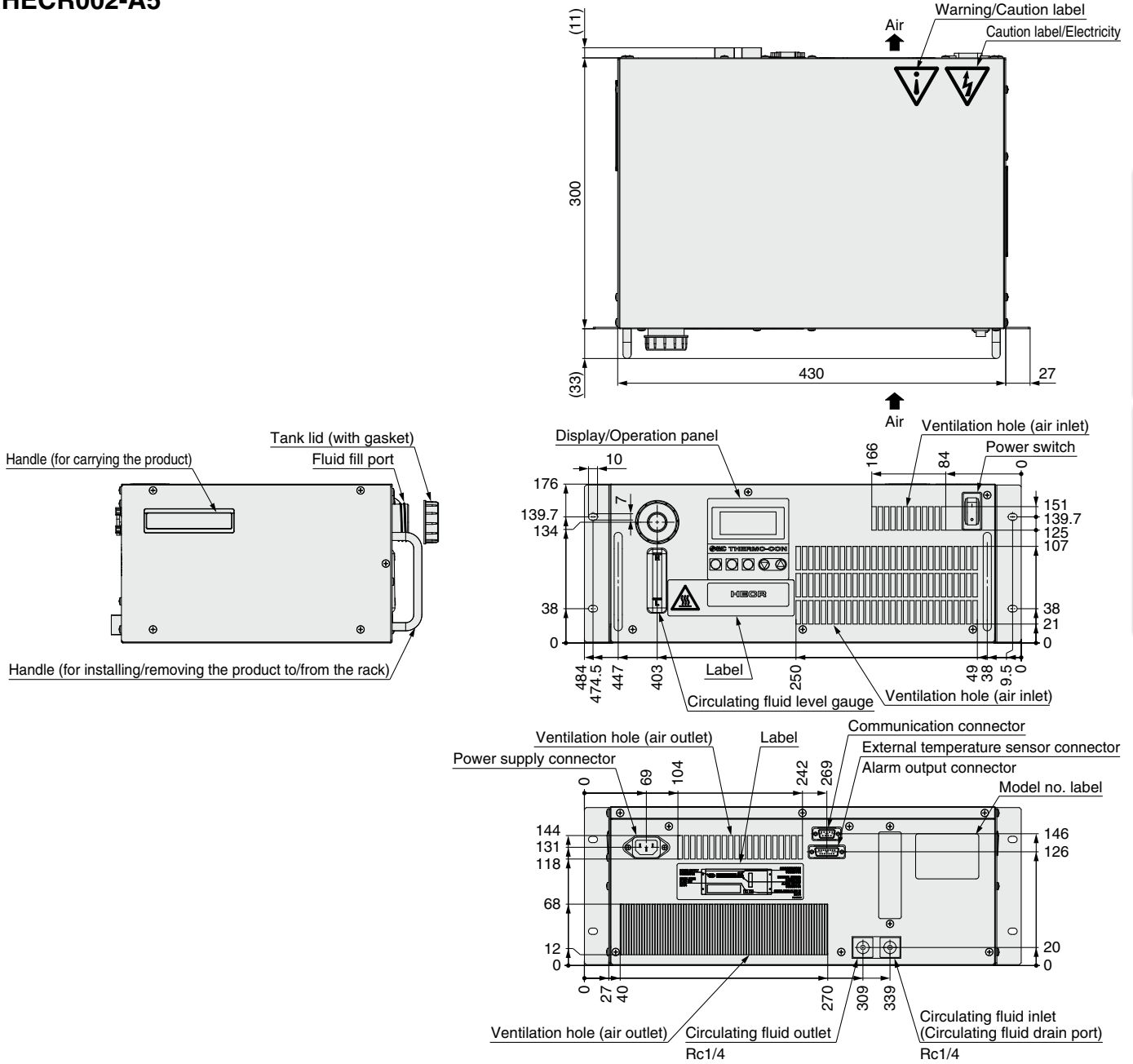

1. Power supply connector IEC60320 C14 (or equivalent)

Pin no.	Signal contents
N	100-240 VAC
L	100-240 VAC
E	PE

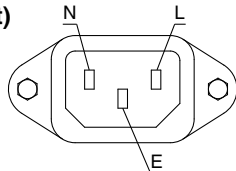

2. Communication connector D-sub 9 pin (socket) Holding screw: M2.6

Pin no.	Signal contents	
	RS-232C	RS-485
1	Unused	BUS+
2	RD	Unused
3	SD	Unused
4	Unused	Unused
5	SG	SG
6-8	Unused	Unused
9	Unused	BUS-

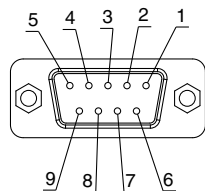

3. External temperature sensor connector/Alarm output connector D-sub 15 pin (socket) Holding screw: M2.6

Pin no.	Signal contents
1-2	Unused
3	Terminal A of resistance temperature detector
4	Terminal B of resistance temperature detector
5	Terminal B of resistance temperature detector
6	Contact a for output cutoff alarm (open when alarm occurs)
7	Common for output cutoff alarm
8	Contact b for output cutoff alarm (closed when alarm occurs)
9	Contact a for upper/lower temp. limit alarm (open when alarm occurs)
10	Common for upper/lower temp. limit alarm
11	Contact b for upper/lower temp. limit alarm (closed when alarm occurs)
12-14	Unused
15	FG

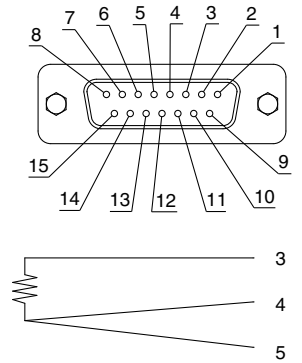

Connection diagram of resistance temperature detector

HECR Series

Dimensions

HECR004-A5

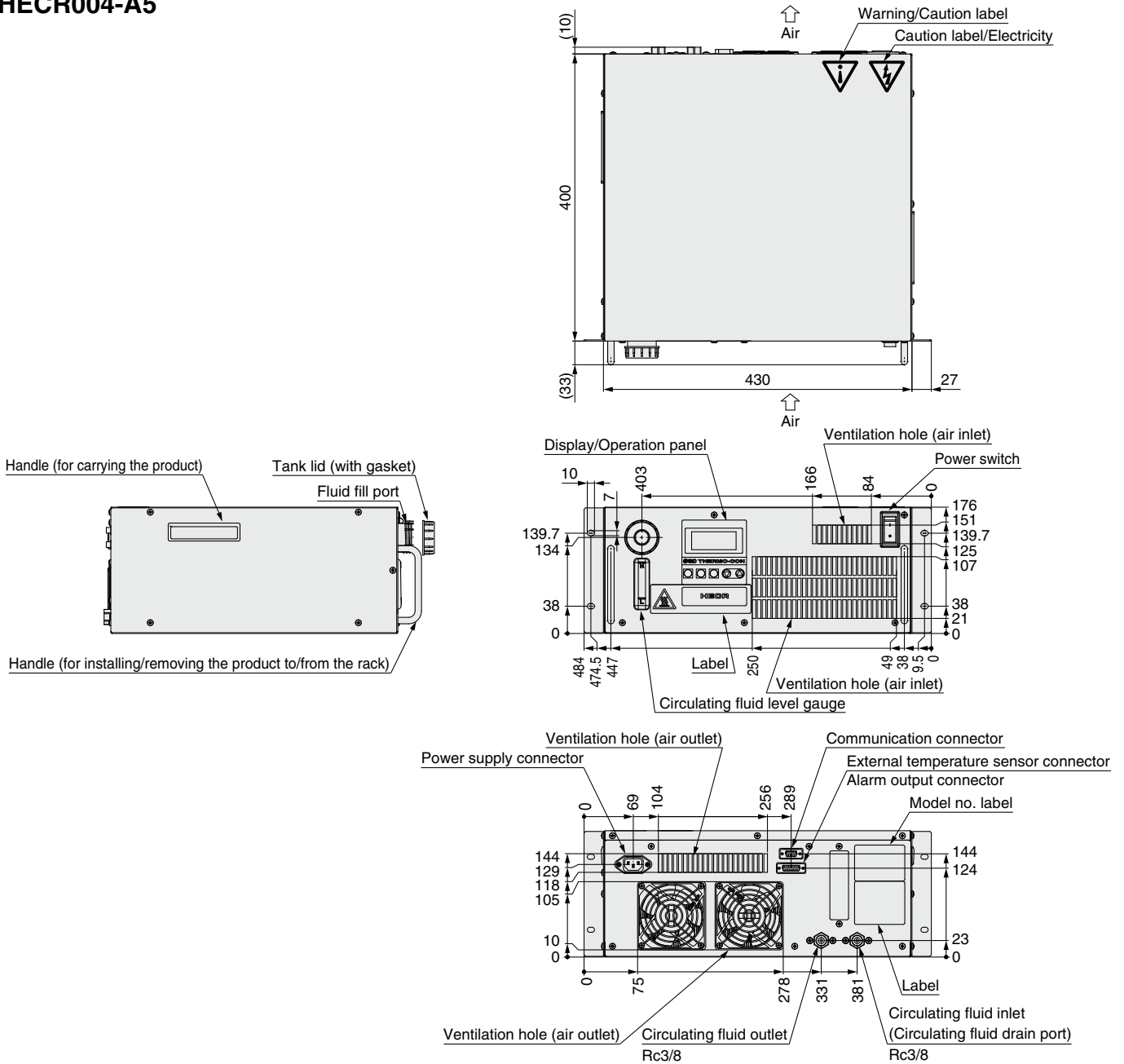

1. Power supply connector IEC60320 C14 (or equivalent)

Pin no.	Signal contents
N	100-240 VAC
L	100-240 VAC
E	PE

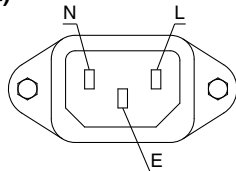

2. Communication connector D-sub 9 pin (socket) Holding screw: M2.6

Pin no.	Signal contents	
	RS-232C	RS-485
1	Unused	BUS+
2	RD	Unused
3	SD	Unused
4	Unused	Unused
5	SG	SG
6-8	Unused	Unused
9	Unused	BUS-

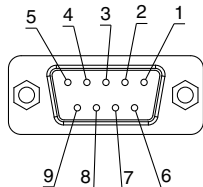

3. External temperature sensor connector/Alarm output connector D-sub 15 pin (socket) Holding screw: M2.6

Pin no.	Signal contents
1-2	Unused
3	Terminal A of resistance temperature detector
4	Terminal B of resistance temperature detector
5	Terminal B of resistance temperature detector
6	Contact a for output cutoff alarm (open when alarm occurs)
7	Common for output cutoff alarm
8	Contact b for output cutoff alarm (closed when alarm occurs)
9	Contact a for upper/lower temp. limit alarm (open when alarm occurs)
10	Common for upper/lower temp. limit alarm
11	Contact b for upper/lower temp. limit alarm (closed when alarm occurs)
12-14	Unused
15	FG

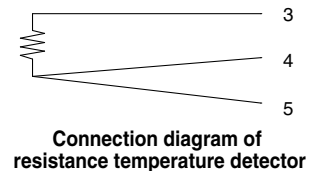
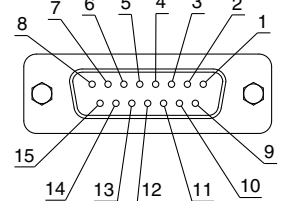

Dimensions

HECR006-A5

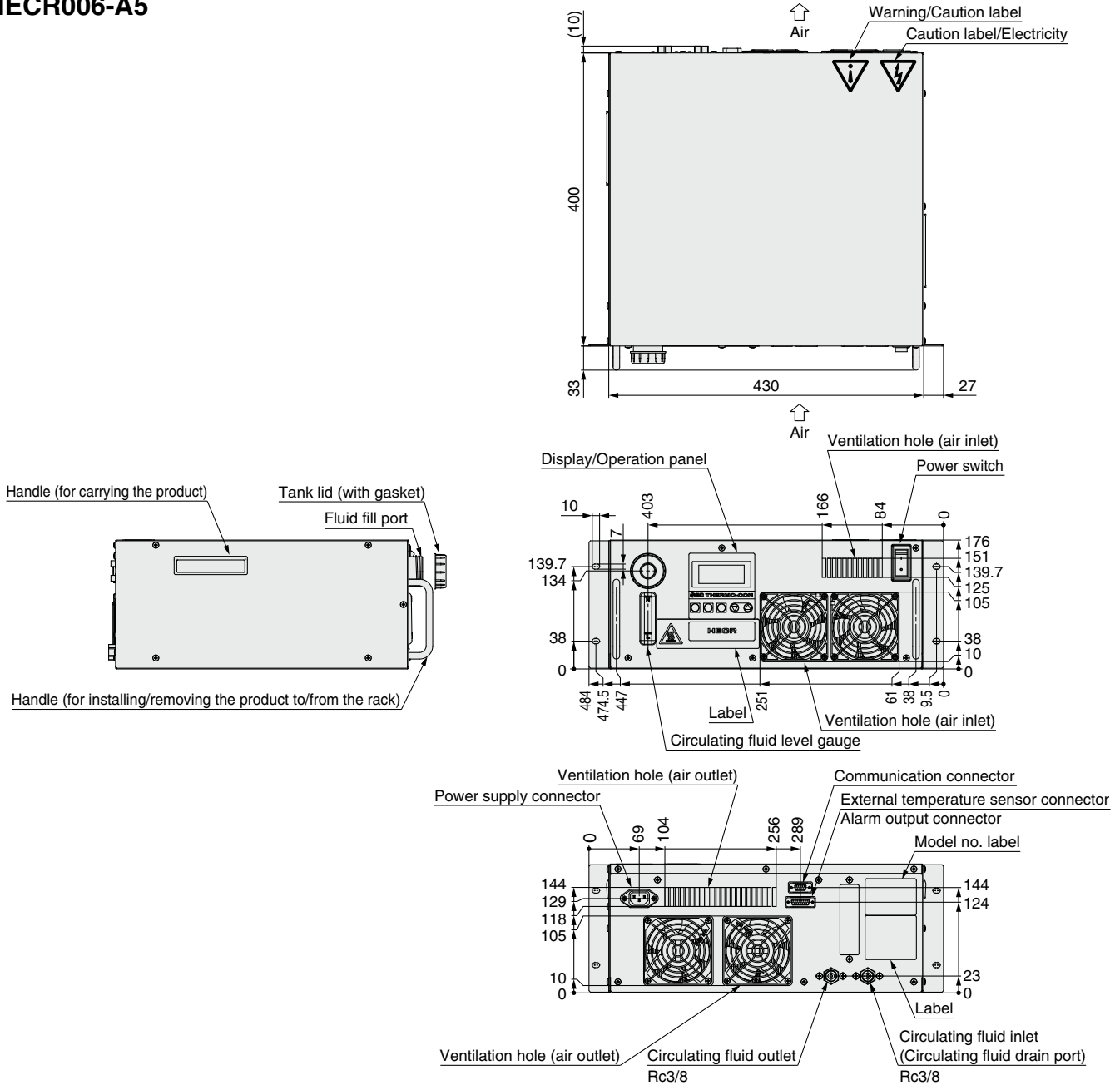

**1. Power supply connector
IEC60320 C14 (or equivalent)**

Pin no.	Signal contents
N	100-240 VAC
L	100-240 VAC
E	PE

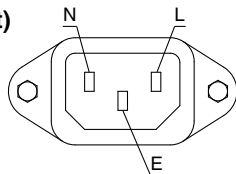

**2. Communication connector
D-sub 9 pin (socket)
Holding screw: M2.6**

Pin no.	Signal contents	
	RS-232C	RS-485
1	Unused	BUS+
2	RD	Unused
3	SD	Unused
4	Unused	Unused
5	SG	SG
6-8	Unused	Unused
9	Unused	BUS-

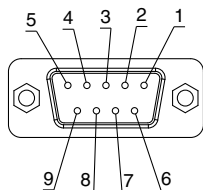

**3. External temperature sensor connector/Alarm output connector
D-sub 15 pin (socket)
Holding screw: M2.6**

Pin no.	Signal contents
1-2	Unused
3	Terminal A of resistance temperature detector
4	Terminal B of resistance temperature detector
5	Terminal B of resistance temperature detector
6	Contact a for output cutoff alarm (open when alarm occurs)
7	Common for output cutoff alarm
8	Contact b for output cutoff alarm (closed when alarm occurs)
9	Contact a for upper/lower temp. limit alarm (open when alarm occurs)
10	Common for upper/lower temp. limit alarm
11	Contact b for upper/lower temp. limit alarm (closed when alarm occurs)
12-14	Unused
15	FG

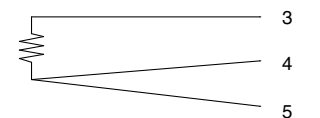
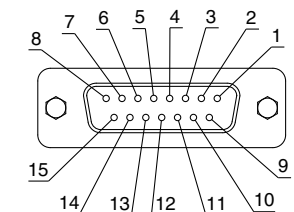

Connection diagram of resistance temperature detector

Model Selection

Air-cooled **HECR-A**

Water-cooled **HECR-W**

Options
Optional Accessories

Specific Product
Precautions

HECR Series

Dimensions

HECR008-A5
HECR010-A2

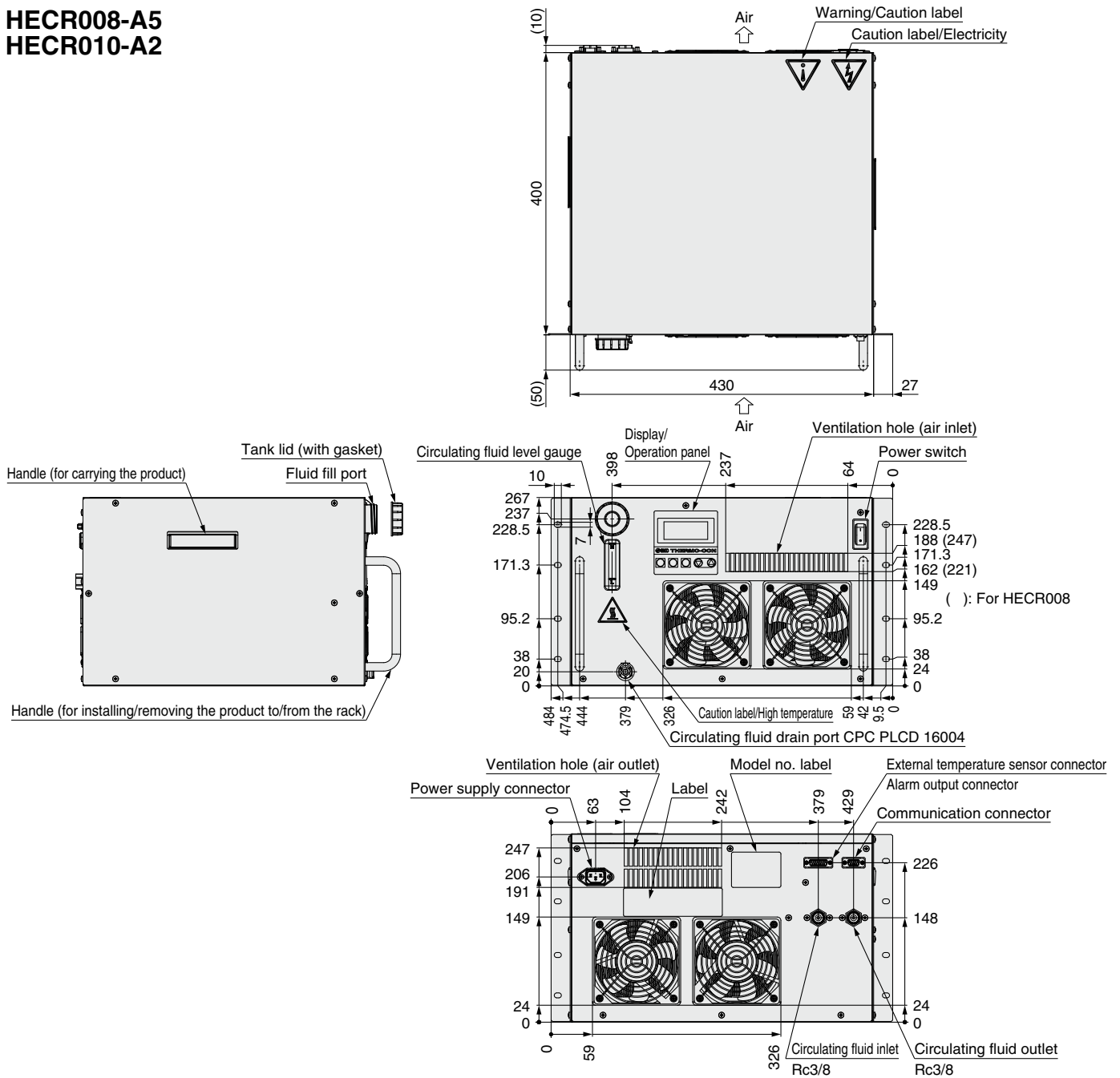

1. Power supply connector IEC60320 C14 (or equivalent)

Pin no.	Signal contents	
	HECR008	HECR010
N	100-240 VAC	200-240 VAC
L	100-240 VAC	200-240 VAC
E	PE	PE

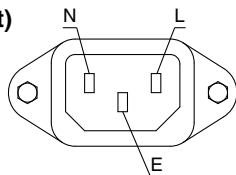

2. Communication connector D-sub 9 pin (socket) Holding screw: M2.6

Pin no.	Signal contents	
	RS-232C	RS-485
1	Unused	BUS+
2	RD	Unused
3	SD	Unused
4	Unused	Unused
5	SG	SG
6-8	Unused	Unused
9	Unused	BUS-

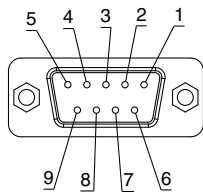

3. External temperature sensor connector/Alarm output connector D-sub 15 pin (socket) Holding screw: M2.6

Pin no.	Signal contents
1-2	Unused
3	Terminal A of resistance temperature detector
4	Terminal B of resistance temperature detector
5	Terminal B of resistance temperature detector
6	Contact a for output cutoff alarm (open when alarm occurs)
7	Common for output cutoff alarm
8	Contact b for output cutoff alarm (closed when alarm occurs)
9	Contact a for upper/lower temp. limit alarm (open when alarm occurs)
10	Common for upper/lower temp. limit alarm
11	Contact b for upper/lower temp. limit alarm (closed when alarm occurs)
12-14	Unused
15	FG

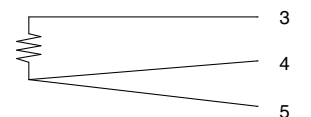
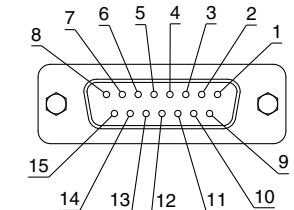

Connection diagram of resistance temperature detector

Thermo-con/ Rack Mount Type

HECR Series Water-cooled



How to Order

HECR 008 - W 5 -

Cooling capacity

008	800 W
012	1.2 kW

Radiating method

W	Water-cooled
---	--------------

Power supply

2	200 to 240 VAC	HECR012
5	100 to 240 VAC	HECR008

Option

Nil	None
E	With feet and no rack mounting brackets
F	With flow switch
P	High-pressure pump mounted

• When multiple options are combined, indicate symbols in alphabetical order.

Pipe thread

Nil	Rc
N	NPT thread

Specifications

Model	HECR008-W	HECR012-W	
Cooling method	Thermoelectric device (Thermo-module)		
Radiating method	Water-cooled		
Control method	Cooling/Heating automatic shift PID control		
Ambient temperature/humidity	10 to 35°C, 35 to 80% RH (No condensation)		
Circulating fluid system	Circulating fluid		
	Tap water, Ethylene glycol 20%		
	Set temperature range		
	10.0 to 60.0°C (No condensation)		
	Cooling capacity	800 W (Tap water)*1	1.2 kW (Tap water)*1
	Heating capacity	1.4 kW (Tap water)*1	2 kW (Tap water)*1
	Temperature stability*2	±0.01 to 0.03°C	
	Pump capacity	Refer to the performance charts. (Page 18)	
Facility water system	Tank capacity		
	Approx. 1.3 L		
	Port size		
	Rc3/8		
	Fluid contact material		
Stainless steel, EPDM, NBR, Ceramics, PPE, PPS, Carbon, PP, PE, Nylon, POM, PVC			
Electrical system	Temperature range		
	10 to 35°C (No condensation)		
	Pressure range		
	Within 1 MPa		
	Required flow rate*3		
	10 to 15 L/min		
	Port size		
	Rc3/8		
Fluid contact material			
Stainless steel 304			
Power supply	Single-phase 100 to 240 VAC ±10%, 50/60 Hz	Single-phase 200 to 240 VAC ±10%, 50/60 Hz	
Overcurrent protector	14 A		
Current consumption	10 A (100 V) to 4 A (240 V)	7 A (200 V) to 6 A (240 V)	
Power consumption	900 W	1200 W	
Alarm	Refer to "Alarm." (Page 20)		
Communications	RS-232C/RS-485		
Weight	Approx. 20 kg	Approx. 21 kg	
Accessories	Power supply connector, Operation Manual Power supply cable should be ordered as an option (sold separately, page 22) or prepared by the user.		
Safety standards	CE marking, UL (NRTL) standards		

*1 Conditions: Circulating fluid set temperature 20°C, Flow rate 3 L/min, Facility water temperature 20°C, Flow rate 10 L/min, Ambient temperature 25°C

*2 The indicated values are with a stable load without turbulence in the operating conditions. It may be out of this range in some other operating conditions.

*3 The flow rate beyond the proper range may deteriorate performance or generate noise, causing the piping to break.

HECR Series

Cooling Capacity

HECR008-W

Circulating fluid: Tap water

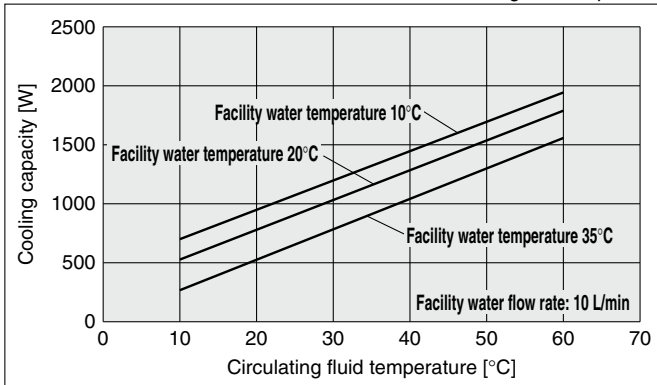

Circulating fluid: Ethylene glycol 20%

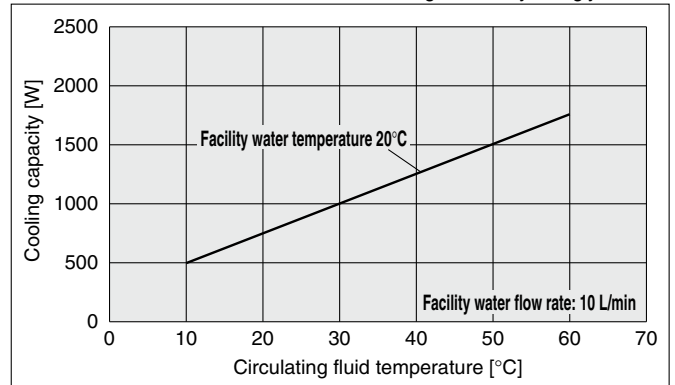

HECR012-W

Circulating fluid: Tap water

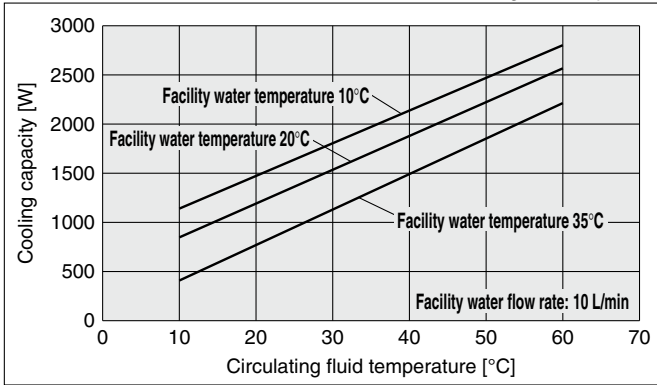

Circulating fluid: Ethylene glycol 20%

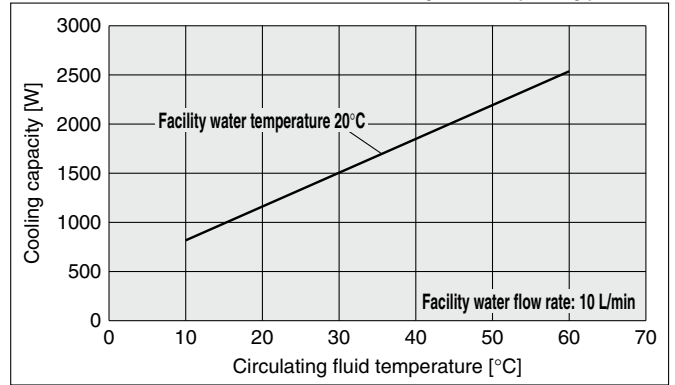

Heating Capacity

HECR008-W

Circulating fluid: Tap water

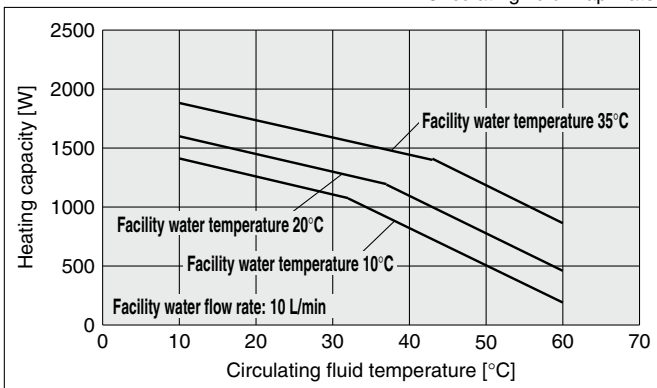

Circulating fluid: Ethylene glycol 20%

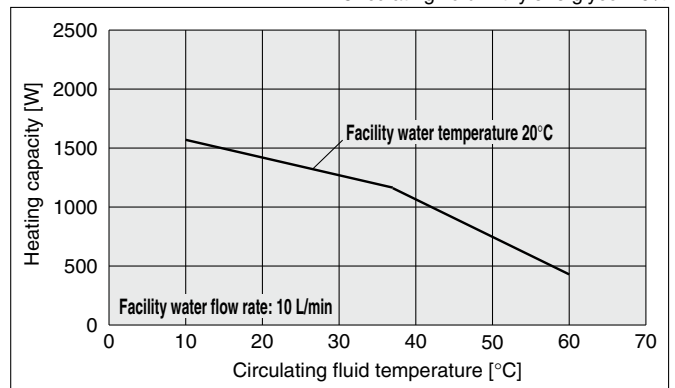

HECR012-W

Circulating fluid: Tap water

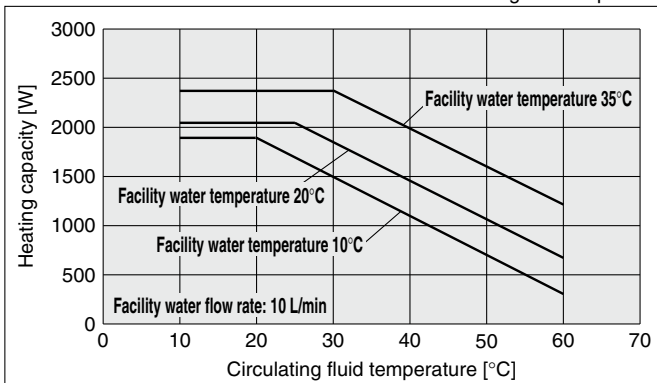

Circulating fluid: Ethylene glycol 20%

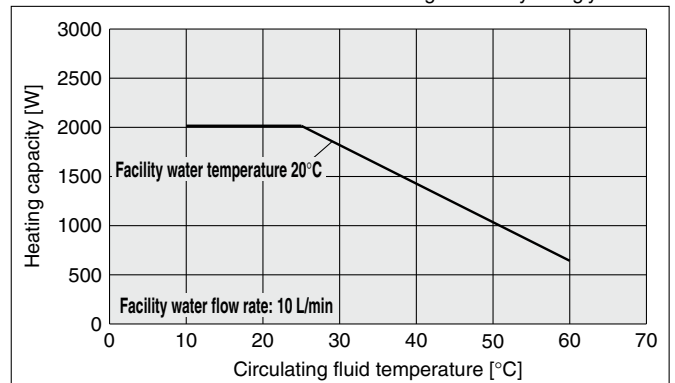

Pump Capacity (Thermo-con Outlet)

HECR008-W/012-W

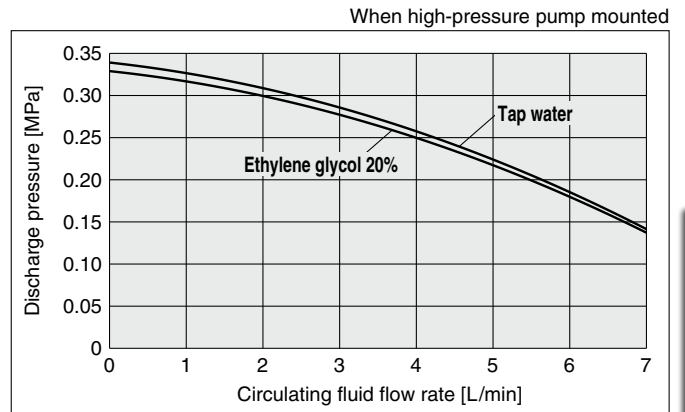
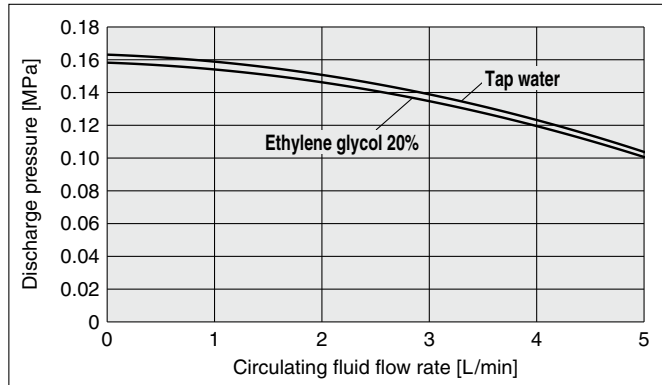

Pressure Loss in Facility Water Circuit

HECR008-W

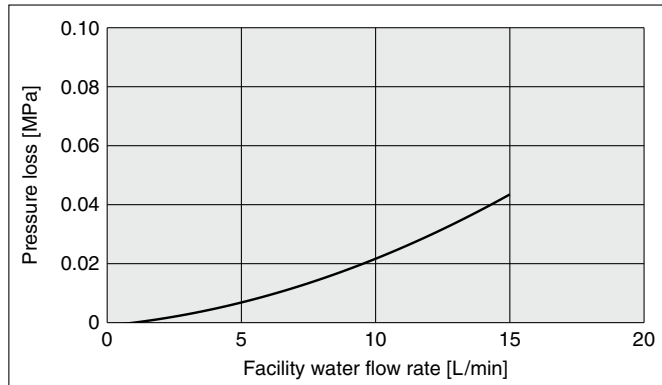

HECR012-W

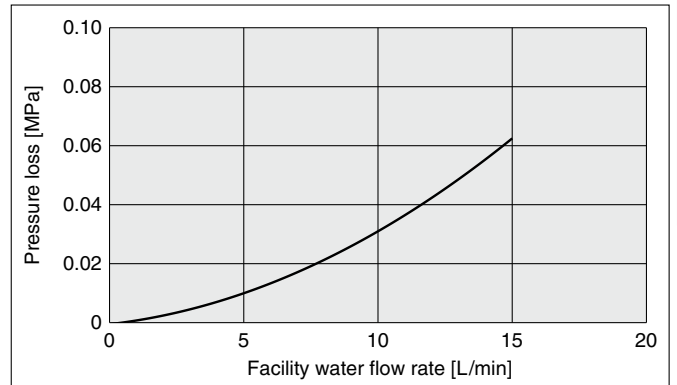

Model Selection

HECR-A
Air-cooled

HECR-W
Water-cooled

Options
Optional Accessories

Specific Product
Precautions

HECR Series

Dimensions

HECR008-W5
HECR012-W2

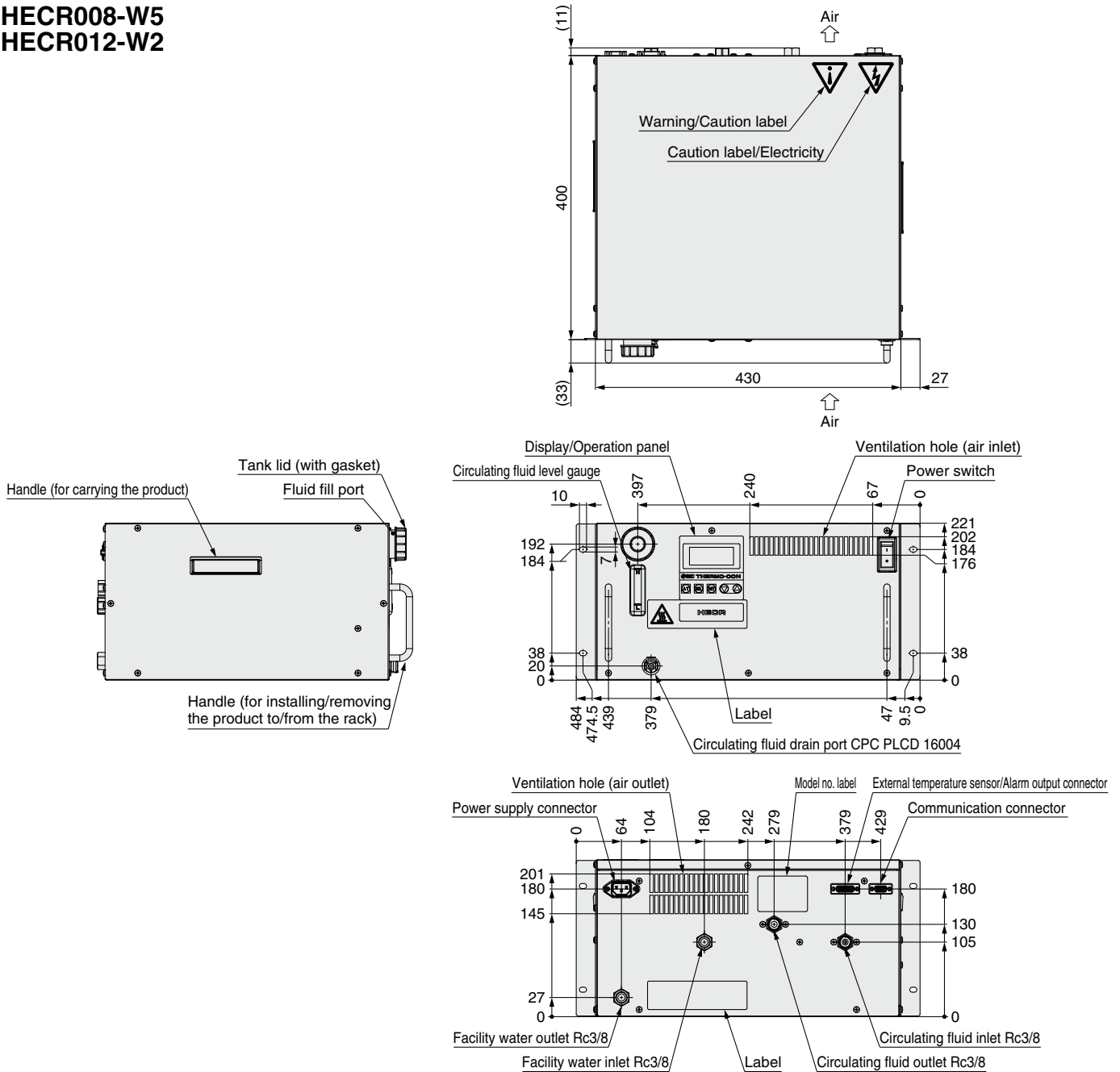

1. Power supply connector IEC60320 C14 (or equivalent)

Pin no.	Signal contents	
	HECR008	HECR012
N	100-240 VAC	200-240 VAC
L	100-240 VAC	200-240 VAC
E	PE	PE

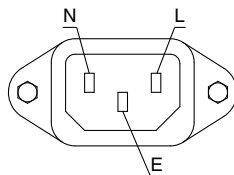

2. Communication connector D-sub 9 pin (socket) Holding screw: M2.6

Pin no.	Signal contents	
	RS-232C	RS-485
1	Unused	BUS+
2	RD	Unused
3	SD	Unused
4	Unused	Unused
5	SG	SG
6-8	Unused	Unused
9	Unused	BUS-

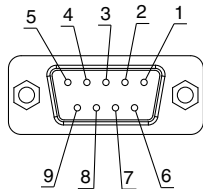

3. External temperature sensor connector/Alarm output connector D-sub 15 pin (socket) Holding screw: M2.6

Pin no.	Signal contents
1-2	Unused
3	Terminal A of resistance temperature detector
4	Terminal B of resistance temperature detector
5	Terminal B of resistance temperature detector
6	Contact a for output cutoff alarm (open when alarm occurs)
7	Common for output cutoff alarm
8	Contact b for output cutoff alarm (closed when alarm occurs)
9	Contact a for upper/lower temp. limit alarm (open when alarm occurs)
10	Common for upper/lower temp. limit alarm
11	Contact b for upper/lower temp. limit alarm (closed when alarm occurs)
12-14	Unused
15	FG

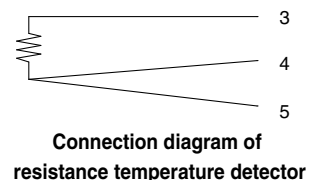
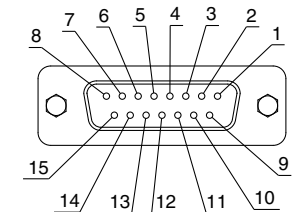

Operation Display Panel

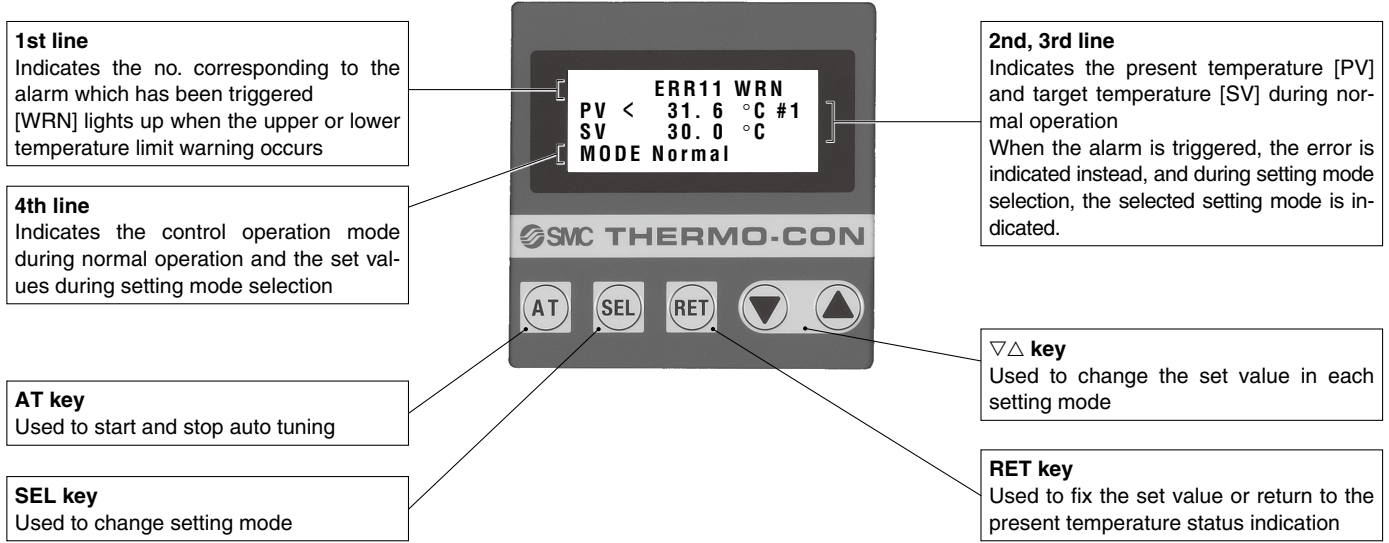

Alarm

This unit is equipped as standard with a function allowing for the display of 14 kinds of alarms on the LCD, and it can be read out by serial communication. Also, it can generate relay output for an upper/lower temperature limit alarm and output cutoff alarm.

Alarm

Alarm code	Alarm description	Operation status	Main reason
WRN	Upper/Lower temp. limit alarm	Continue	The temperature has exceeded the upper/lower limit range for the target temperature.
ERR01	System error 1	Stop	The internal cable of the thermo-con has been broken due to abnormal vibration or dropping of the product.
ERR02	System error 2	Stop	EEPROM data has been lost due to high-level noise.
ERR03	Back-up data error	Stop	The EEPROM data of the controller has been destroyed due to high-level noise.
ERR11	DC power supply failure	Stop	The DC power supply has failed (due to a fan stoppage or an abnormally high temperature) or the thermo-module has been short-circuited.
ERR12	Internal temp. sensor high temp. error	Stop	The internal temperature sensor has exceeded the high temperature cutoff setting.
ERR13	Internal temp. sensor low temp. error	Stop	The internal temperature sensor has exceeded the low temperature cutoff setting.
ERR14	Thermostat alarm	Stop	The thermostat has been activated due to radiator fin clog, insufficient flow of the facility water, high temperature, fan/pump failure, etc.
ERR15	Abnormal output alarm	Continue	The temperature cannot be changed even at 100% output due to an overload or disconnection of the thermo-module.
ERR16	Low flow rate alarm (Option)	Stop	The flow rate of the circulating fluid has dropped.
ERR17	Internal temp. sensor disconnection alarm	Stop	The internal temperature sensor has been disconnected or short-circuited.
ERR18	External temp. sensor disconnection alarm	Continue	The external temperature sensor has been disconnected or short-circuited. (Only detected when in learning control or external tune control)
ERR19	Abnormal auto tuning alarm	Stop	Auto tuning has not been completed within 20 minutes.
ERR20	Low fluid level alarm	Stop	The amount of circulating fluid in the tank has dropped.

Maintenance

The maintenance of this unit can only be performed by returning it to be repaired at one of SMC's sites. As a rule, SMC will not conduct on-site maintenance.

Model Selection

Air-cooled **HECR-A**

Water-cooled **HECR-W**

Options
Optional Accessories

Specific Product
Precautions

HECR Series Air-cooled Water-cooled

Options

* Options have to be selected when ordering the thermo-con. It is not possible to add them after purchasing the unit.

E Option symbol With Feet and No Rack Mounting Brackets

HECR □□-□□□□-**E**
 ● With feet and no rack mounting brackets

Rack mounting brackets and handles on the front side are removed as they are not necessary when the product is not mounted in a rack. This option has rubber feet for installing the product on the floor.

Applicable model	Dimensions [mm]		
	A	B	C
HECR002-A5□-E	14	230	35
HECR004-A5□-E		310	45
HECR006-A5□-E			44
HECR008-A5□-E	13	310	46
HECR010-A2□-E			44
HECR008-W5□-E			46
HECR012-W2□-E			

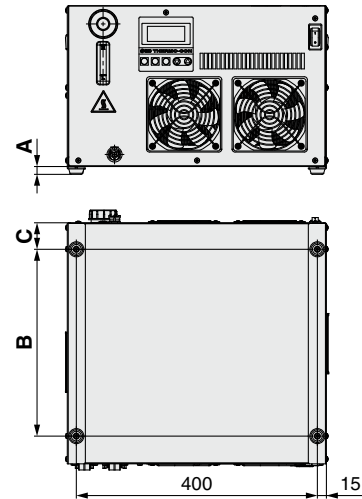

F Option symbol With Flow Switch

HECR □□-□□□□-**F**
 ● With flow switch

This is an ON/OFF switch detecting low levels of the circulating fluid. When the fluid volume is 1 L/min or less, "ERR16" is displayed and the thermo-con stops. The flow switch is built into the thermo-con.

Applicable model
HECR002-A5□-F
HECR004-A5□-F
HECR006-A5□-F
HECR008-A5□-F
HECR010-A2□-F
HECR008-W5□-F
HECR012-W2□-F

P Option symbol High-Pressure Pump Mounted

HECR □□-□□□□-**P**
 ● High-pressure pump mounted

Possible to choose a high-pressure pump in accordance with user's piping resistance. Cooling capacity will decrease by approx. 20 W (HECR002) or approx. 50 W (HECR004/006/008/010/012) by heat generated in the pump.

Applicable model
HECR002-A5□-P
HECR004-A5□-P
HECR006-A5□-P
HECR008-A5□-P
HECR010-A2□-P
HECR008-W5□-P
HECR012-W2□-P

HECR Series Air-cooled Water-cooled

Optional Accessories

Power Supply Cable

⚠ The power supply cable can only be used for the applicable models shown below. Do not use it for other products.

■ For single-phase 100/115 VAC type

* Not applicable for the 200 V type

Part no.	Applicable model
HRS-CA001	HECR002
	HECR004
	HECR006
	HECR008

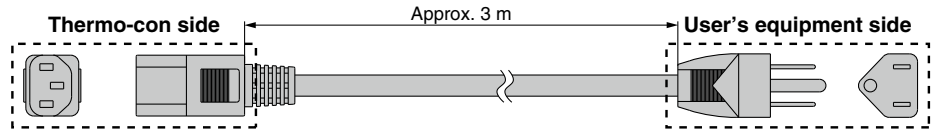

* Not applicable to the retaining clip

Part no.	Applicable model
HRS-CA003	HECR002
	HECR004
	HECR006
	HECR008

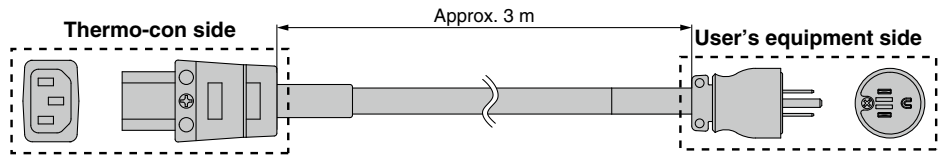

* Applicable to the retaining clip

■ For single-phase 200 VAC type

* Also applicable for the 100 VAC type, but the connector for the user's equipment needs to be prepared by the user.

Part no.	Applicable model
HRS-CA002	HECR002
	HECR004
	HECR006
	HECR008
	HECR010
	HECR012

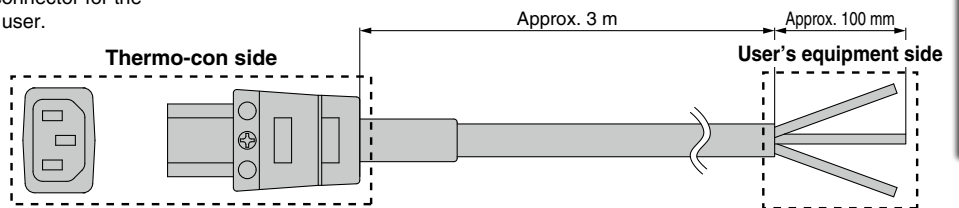

* Applicable to the retaining clip

■ Retaining clip

Holds the connector on the thermo-con side in position

Part no.	Applicable power supply cable model
HRS-S0074	HRS-CA002
	HRS-CA003
	Power supply connector for accessory

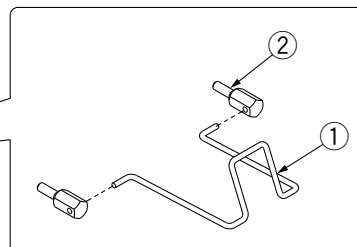
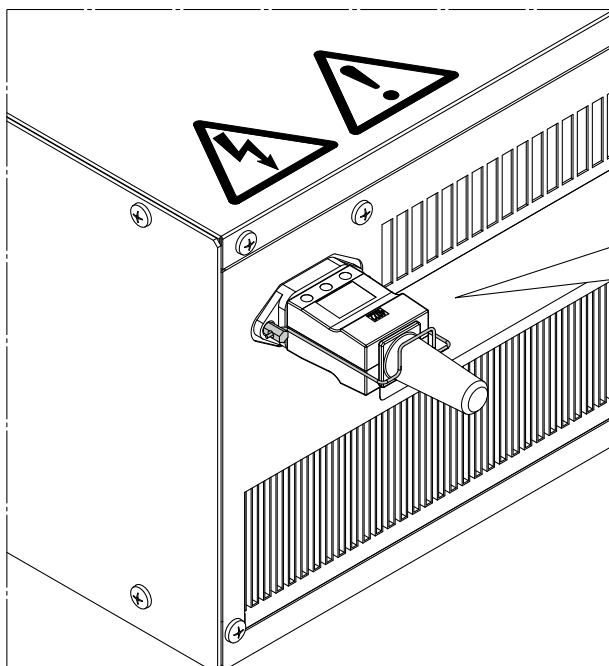

Parts List

No.	Description
①	Retaining clip
②	Holding screw

Model Selection

Air-cooled **HECR-A**

Water-cooled **HECR-W**

Options
Optional Accessories

Specific Product
Precautions



HECR Series Specific Product Precautions 1

Be sure to read this before handling the products. Refer to the back cover for safety instructions. For temperature control equipment precautions, refer to the “Handling Precautions for SMC Products” and the “Operation Manual” on the SMC website: <http://www.smcworld.com>

Design

⚠ Warning

- This catalog shows the specifications of the thermo-con.**
 - Check the detailed specifications in the separate “Product Specifications”, and evaluate the compatibility of the thermo-con with user’s system.
 - Although the protection circuit as a single unit is installed, the user is requested to carry out the safety design for the whole system.

Handling

⚠ Warning

- Thoroughly read the operation manual.**
Read the operation manual completely before operation, and keep the manual where it can be referred to as necessary.
- If the set temperature is repeatedly changed by 10°C or more, the thermo-con may fail in short periods of time.**

Operating Environment/Storage Environment

⚠ Warning

- Keep within the specified ambient temperature and humidity range.**
Also, if the set temperature is too low, condensation may form on the inside of the thermo-con or the surface of piping even within the specified ambient temperature range. Dew condensation can cause failure, and so must be avoided by considering operating conditions.
- The thermo-con is not designed for clean room usage.**
The pump and fan generate dust.
- Low molecular siloxane can damage the contact of the relay.**
Use the thermo-con in a place free from low molecular siloxane.

Transportation/Movement/Installation

⚠ Caution

- Avoid strong vibration and/or impact.**
The product is precision equipment. Do not apply vibration or impact during transportation.
- Caution when moving a heavy object.**
This product is heavy. Use adequate caution to avoid injury when picking up and setting down the product, and dropping accidents should be avoided.
- Installation**
When installing the product into a rack, it should be designed that the product weight is held with the bottom surface of the product. Use the handles on the front side of the product when installing/removing the product to/from the rack.

Radiation Air

⚠ Caution

- The inlet for radiation air must not be exposed to particles and dust as far as possible.**
- Do not let the inlet and outlet for radiation air get closed.**
- If more than one thermo-con is used, consider their arrangement so that the downstream sides of the thermo-cons suck radiation air from the upstream sides.**
Otherwise, the performance at the downstream sides may deteriorate. Also, the set temperature may not be achieved depending on the value of the set temperature and the load. In such a case, take countermeasures such as changing the direction of the thermo-cons to prevent the deterioration of performance.
- Filters are not built in. Mount them as necessary.**
- The table below summarizes the flow rate of the radiation air and heat generation (maximum values).**

Model	Air flow [m ³ /min]	Heat generation [W]
HECR002-A	2	600
HECR004-A	5	1300
HECR006-A	5	1400
HECR008-A	7	1700
HECR010-A	7	2500
HECR008-W	0.2	200
HECR012-W	0.4	250

Facility Water

⚠ Caution

- If the temperature of the facility water is too low, it can cause formation of dew condensation inside the heat exchanger.**
Supply facility water with a temperature over the atmospheric dew point to avoid the formation of dew condensation.
- If the facility water piping is connected to multiple machines, the facility water exchanges heat at the upstream side and its temperature will become higher as it goes downstream.**
Limit the number of connected thermo-cons to two per facility water system, and if more than two thermo-cons are to be connected, increase the number of systems.

■ Required facility water system

<Heat radiation amount/Facility water specifications>

Model	Heat radiation [kW]	Facility water specifications
HECR008-W	Approx. 2	Refer to “Facility water system” in the specifications.
HECR012-W	Approx. 3	

Circulating Fluid

⚠ Caution

- Use a fluid that is listed in the specifications.**
- Deionized water (with an electric conductivity of approximately 1 μS/cm) can be used, but may lose its electric conductivity.**
Also, if a facility supplying deionized water is used, the thermo-con may be damaged by static electricity.



HECR Series

Specific Product Precautions 2

Be sure to read this before handling the products. Refer to the back cover for safety instructions. For temperature control equipment precautions, refer to the "Handling Precautions for SMC Products" and the "Operation Manual" on the SMC website: <http://www.smcworld.com>

Circulating Fluid

Caution

3. If deionized water is used, bacteria and algae may grow within a short period.

If the thermo-con is operated with bacteria and algae present, its cooling capacity or the capacity of the pump may deteriorate. Replace all deionized water regularly according to the conditions (once a month as a guide).

4. If using a fluid other than those listed in the specifications, please contact SMC beforehand.

5. The maximum operating pressure of the resin tank is 0.1 MPa.

If this pressure is exceeded, leakage from the tank in the thermo-con may result.

6. Select a pipe with a length and diameter which allows a flow rate of 0.5 L/min or more (HECR002-A) or 1 L/min or more (HECR004-A/006-A/008-A/010-A) for the circulating fluid. Also, allow a flow rate of 3 L/min or more for the HECR008-W/012-W.

If the flow rate is less than these values, the thermo-con will not be able to provide precise control, and the repeated cooling and heating operations may cause it to fail.

7. A magnet driven pump is used as the circulating pump.

Fluids which contain metal powders such as iron powder cannot be used.

8. The thermo-con must not be operated without circulating fluid.

The pump can break due to idling.

9. If the tank lid is opened after the supply of circulating fluid, the circulating fluid may spill out depending on the condition of the external piping.

10. If an external tank is used, the circulating fluid may spill out from the internal tank lid depending on where the external tank is installed.

Confirm that the internal tank has no leakage if using an external tank.

11. If there is a point where fluid is released to atmosphere externally (tank or piping), minimize the piping resistance at the circulating fluid return side.

If the piping resistance is too large, the piping may be crushed or the built-in circulator tank may be deformed or cracked because the pressure in the piping for return will become negative. The built-in circulator tank is made of resin (PE). Therefore, the tank may be crushed if the pressure is negative. Special attention must be paid if the flow rate of the circulating fluid is high. To avoid a negative pressure of -0.02 MPa or below, the piping return should be as thick and short as possible to minimize piping resistance. It is also effective to restrict the flow rate of circulating fluid or remove the gasket of the internal tank for the release to atmosphere.

12. Fluorinated fluid falls outside of the specifications.

If it is used in the thermo-con, static electricity will be generated by the flow of fluid. This static electricity may be discharged to the board of the thermo-con, causing damage, operation failure, or loss of data such as set temperatures.

Also, as the specific gravity of the fluorinated fluid is 1.5 to 1.8 times that of water, the pump will be overloaded, which also causes fluorinated fluid to fall outside the specifications. Therefore, if fluorinated fluid is to be used, please contact SMC and we will introduce you to a suitable special product (water-cooled type).

Caution

13. Avoid operation with cavitation or bubbles due to low fluid level in the tank. This may shorten the pump life.

14. If tap water is used, it should satisfy the quality standards shown below.

Tap Water (as a Circulating Fluid) Quality Standards

The Japan Refrigeration and Air Conditioning Industry Association

JRA GL-02-1994 "Cooling water system - Circulating type - Make-up water"

	Item	Unit	Standard value	Influence	
				Corrosion	Scale generation
Standard item	pH (at 25°C)	—	6.0 to 8.0	○	○
	Electric conductivity (25°C)	[μS/cm]	100*1 to 300*1	○	○
	Chloride ion (Cl ⁻)	[mg/L]	50 or less	○	
	Sulfuric acid ion (SO ₄ ²⁻)	[mg/L]	50 or less	○	
	Acid consumption amount (at pH4.8)	[mg/L]	50 or less		○
	Total hardness	[mg/L]	70 or less		○
	Calcium hardness (CaCO ₃)	[mg/L]	50 or less		○
Reference item	Ionic state silica (SiO ₂)	[mg/L]	30 or less		○
	Iron (Fe)	[mg/L]	0.3 or less	○	○
	Copper (Cu)	[mg/L]	0.1 or less	○	
	Sulfide ion (S ₂ ⁻)	[mg/L]	Should not be detected.	○	
	Ammonium ion (NH ₄ ⁺)	[mg/L]	0.1 or less	○	
	Residual chlorine (Cl)	[mg/L]	0.3 or less	○	
	Free carbon (CO ₂)	[mg/L]	4.0 or less	○	

*1 In the case of [MΩ·cm], it will be 0.003 to 0.01.

○: Factors that have an effect on corrosion or scale generation

• Even if the water quality standards are met, complete prevention of corrosion is not guaranteed.

15. The tank capacity is approximately 1 liter at the High level and approximately 0.4 liters at the Low level. When the fluid level goes below the Low level, "ERR20" (Low fluid level alarm) will be triggered.

Maintenance

Warning

1. Prevention of electric shocks and fire

Do not operate the switch with wet hands. Also, do not operate the thermo-con when water is present on its exterior surface.

2. Action in the case of error

If any error such as an abnormal sound, smoke, or bad odor occurs, cut off the power at once, and stop supplying and conveying fluid. Please contact SMC or a sales distributor to repair the thermo-con.

3. Regular inspection

Check the following items at least once a month. The inspection must be done by an operator who has sufficient knowledge and experience.

- Check the displayed contents.
- Check the temperature, vibration level, and for abnormal sounds in the body of the thermo-con.
- Check the voltage and current of the power supply system.
- Check the circulating fluid for leakage, contamination, and the presence of foreign matter. Replace the fluid when necessary.
- Check the flow condition and temperature of the radiated air.

Safety Instructions

These safety instructions are intended to prevent hazardous situations and/or equipment damage. These instructions indicate the level of potential hazard with the labels of “**Caution**,” “**Warning**” or “**Danger**.” They are all important notes for safety and must be followed in addition to International Standards (ISO/IEC)*1), and other safety regulations.

 **Caution:** **Caution** indicates a hazard with a low level of risk which, if not avoided, could result in minor or moderate injury.

 **Warning:** **Warning** indicates a hazard with a medium level of risk which, if not avoided, could result in death or serious injury.

 **Danger :** **Danger** indicates a hazard with a high level of risk which, if not avoided, will result in death or serious injury.

*1) ISO 4414: Pneumatic fluid power – General rules relating to systems.
ISO 4413: Hydraulic fluid power – General rules relating to systems.
IEC 60204-1: Safety of machinery – Electrical equipment of machines.
(Part 1: General requirements)
ISO 10218-1: Manipulating industrial robots – Safety.
etc.

Warning

1. The compatibility of the product is the responsibility of the person who designs the equipment or decides its specifications.

Since the product specified here is used under various operating conditions, its compatibility with specific equipment must be decided by the person who designs the equipment or decides its specifications based on necessary analysis and test results. The expected performance and safety assurance of the equipment will be the responsibility of the person who has determined its compatibility with the product. This person should also continuously review all specifications of the product referring to its latest catalog information, with a view to giving due consideration to any possibility of equipment failure when configuring the equipment.

2. Only personnel with appropriate training should operate machinery and equipment.

The product specified here may become unsafe if handled incorrectly. The assembly, operation and maintenance of machines or equipment including our products must be performed by an operator who is appropriately trained and experienced.

3. Do not service or attempt to remove product and machinery/equipment until safety is confirmed.

1. The inspection and maintenance of machinery/equipment should only be performed after measures to prevent falling or runaway of the driven objects have been confirmed.
2. When the product is to be removed, confirm that the safety measures as mentioned above are implemented and the power from any appropriate source is cut, and read and understand the specific product precautions of all relevant products carefully.
3. Before machinery/equipment is restarted, take measures to prevent unexpected operation and malfunction.

4. Contact SMC beforehand and take special consideration of safety measures if the product is to be used in any of the following conditions.

1. Conditions and environments outside of the given specifications, or use outdoors or in a place exposed to direct sunlight.
2. Installation on equipment in conjunction with atomic energy, railways, air navigation, space, shipping, vehicles, military, medical treatment, combustion and recreation, or equipment in contact with food and beverages, emergency stop circuits, clutch and brake circuits in press applications, safety equipment or other applications unsuitable for the standard specifications described in the product catalog.
3. An application which could have negative effects on people, property, or animals requiring special safety analysis.
4. Use in an interlock circuit, which requires the provision of double interlock for possible failure by using a mechanical protective function, and periodical checks to confirm proper operation.

Caution

1. The product is provided for use in manufacturing industries.

The product herein described is basically provided for peaceful use in manufacturing industries.
If considering using the product in other industries, consult SMC beforehand and exchange specifications or a contract if necessary.
If anything is unclear, contact your nearest sales branch.

Limited warranty and Disclaimer/ Compliance Requirements

The product used is subject to the following “Limited warranty and Disclaimer” and “Compliance Requirements”.

Read and accept them before using the product.

Limited warranty and Disclaimer

1. The warranty period of the product is 1 year in service or 1.5 years after the product is delivered, whichever is first.*2)
Also, the product may have specified durability, running distance or replacement parts. Please consult your nearest sales branch.
2. For any failure or damage reported within the warranty period which is clearly our responsibility, a replacement product or necessary parts will be provided.
This limited warranty applies only to our product independently, and not to any other damage incurred due to the failure of the product.
3. Prior to using SMC products, please read and understand the warranty terms and disclaimers noted in the specified catalog for the particular products.

*2) Vacuum pads are excluded from this 1 year warranty.

A vacuum pad is a consumable part, so it is warranted for a year after it is delivered.
Also, even within the warranty period, the wear of a product due to the use of the vacuum pad or failure due to the deterioration of rubber material are not covered by the limited warranty.

Compliance Requirements

1. The use of SMC products with production equipment for the manufacture of weapons of mass destruction (WMD) or any other weapon is strictly prohibited.
2. The exports of SMC products or technology from one country to another are governed by the relevant security laws and regulations of the countries involved in the transaction. Prior to the shipment of a SMC product to another country, assure that all local rules governing that export are known and followed.

Caution

SMC products are not intended for use as instruments for legal metrology.

Measurement instruments that SMC manufactures or sells have not been qualified by type approval tests relevant to the metrology (measurement) laws of each country. Therefore, SMC products cannot be used for business or certification ordained by the metrology (measurement) laws of each country.

Revision History

Edition B	* Cooling capacities of 800 W and 1 kW have been added. * Number of pages has been increased from 16 to 20.	TT
Edition C	* Cooling capacities of 400 W and 510 W have been added. * Number of pages has been increased from 20 to 24.	UO
Edition D	* The water-cooled type (800 W, 1.2 kW) has been added. * Number of pages has been increased from 24 to 28.	WO

Safety Instructions

Be sure to read the “Handling Precautions for SMC Products” (M-E03-3) and “Operation Manual” before use.