

# 3 Port Solenoid Valve

## VP300/500/700 Series



RoHS

### Selectable power consumption!

# 0.4 w

[Low wattage specification]

# 0.55 w 1.55 w

[With power saving circuit]

[Standard]

[Starting 1.55 W, Holding 0.55 W] \* Current model: 2.0 W  
With DC light



VP300 series

### Low wattage specification added

\* VP300/500

P.1278

**Power consumption** **0.35 w** (Without light)  
**0.4 w** (With light)



### Power consumption is reduced by power saving circuit.

Power consumption is decreased by approx. 1/3 by reducing the wattage required to hold the valve in an energized state. (Effective energizing time is over 40 ms at 24 VDC.) Refer to electrical power waveform as shown below.

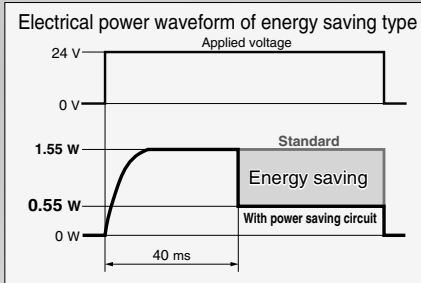

### ■ Built-in full-wave rectifier (AC)

#### ● Noise reduction

Noise is considerably reduced by changing it to DC mode with a full-wave rectifier.

#### ● Reduced apparent power

Current 5.6 VA → **1.55 VA** [Standard]

### ■ Longer life expectancy: 50 million cycles or more

(Current: 20 million cycles) \* Based on SMC test conditions.

### ■ Built-in strainer in the pilot valve

Unexpected troubles due to foreign matter can be prevented.  
(Note) Be sure to mount an air filter on the inlet side.

**Rubber material: HNBR**  
**Ozone-resistant specification**  
\* The pilot valve poppet is made of FKM.

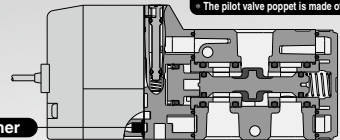

Strainer

SYJ

VQZ

VP

VG

VP3

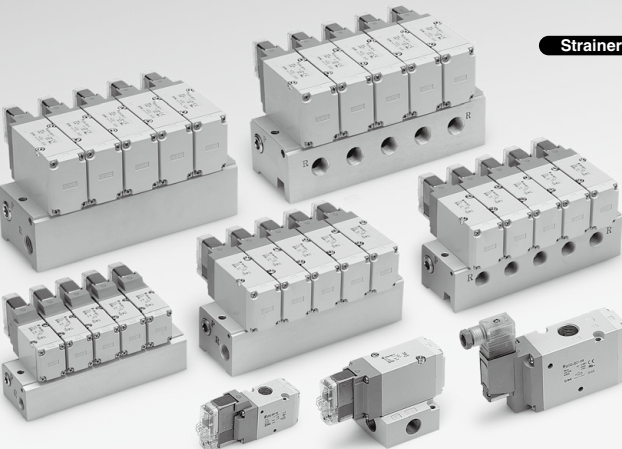

### Air Operated Valve



















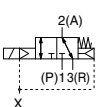

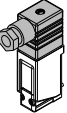
## VPA300/500/700 Series

P.1555

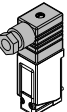

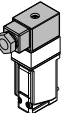
## Model Selection by Operating Conditions ①

### Solenoid Valve: Single Unit

|              | Series  | Sonic conductance<br>C [dm <sup>2</sup> /(s·bar)] | Type of actuation  | Port<br>size | Voltage                                  | Electrical<br>entry   | Light/surge<br>voltage suppressor  | Manual<br>override  |
|--------------|---|---|--|--------------|--|---|--|---|
| Body ported  | <b>VP300</b><br>   | 4.2   | Internal pilot<br>N.C.<br><br>2(A)<br>(P)1 3(R)           | 1/8<br>1/4   |  | Grommet<br>  |  |   |
|              | <b>VP500</b><br>   | 8.9   | N.O.<br><br>2(A)<br>(P)1 3(R)                             | 1/4<br>3/8   |  | L-type plug<br>connector<br>   |  | Non-locking<br>push type<br>             |
|              | <b>VP700</b><br>   | 15.3  | External pilot<br>N.C./N.O.<br><br>2(A)<br>(P)1 3(R)<br>X | 3/8<br>1/2   | 12 VDC<br>24 VDC<br>24 VAC<br>100 VAC    | M-type plug<br>connector<br><br><br>DIN<br>terminal<br> | DC<br>■ With surge voltage<br>suppressor<br>■ With light/surge<br>voltage suppressor<br>■ With surge voltage<br>suppressor<br>(Non-polar)<br>■ With light/surge<br>voltage suppressor<br>(Non-polar)<br><br>AC<br>■ With light/surge<br>voltage suppressor | Push-turn<br>locking<br>slotted type<br> |
| Base mounted | <b>VP300</b><br>   | 3.8   | Internal pilot<br>N.C.<br><br>2(A)<br>(P)1 3(R)           | 1/8<br>1/4   | 200 VAC<br>110 VAC<br>220 VAC<br>240 VAC | DIN (EN1753<br>01-803)<br>terminal<br>   |  |   |
|              | <b>VP500</b><br> | 8.8   | N.O.<br><br>2(A)<br>(P)1 3(R)                           | 1/4<br>3/8   |  | Conduit<br>terminal<br>  |  | Push-turn<br>locking<br>lever type<br> |
|              | <b>VP700</b><br> | 15.0  | External pilot<br>N.C.<br><br>2(A)<br>(P)1 3(R)<br>X    | 3/8<br>1/2   |  |   |  |   |



P. 1264

P. 1271

Low wattage specification From page 1278 Power consumption: 0.35 W (Without light) 0.4 W (With light)

## Model Selection by Operating Conditions ②

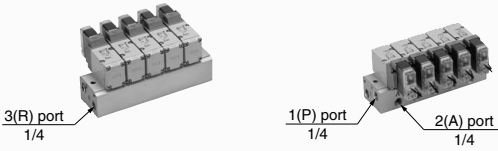
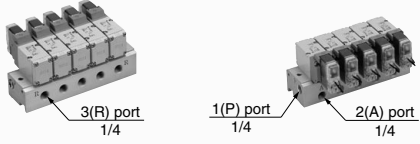
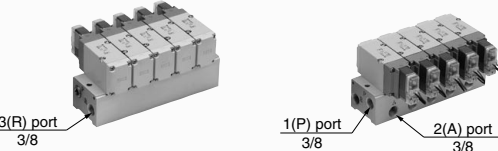
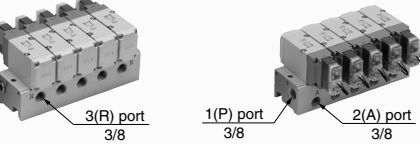
### Solenoid Valve: Manifold

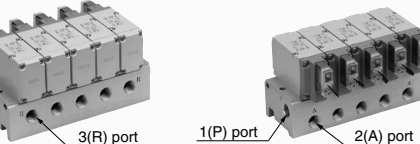
| Series | EXH port type  | Manifold base model  | Applicable stations <small>(Note)</small> |
|--------|----------------|--|---|
| VP300  | Common EXH     | <b>VV3P3-41</b><br>   | 2 to 20 stations                          |
|        | Individual EXH | <b>VV3P3-42</b><br>   |   |
| VP500  | Common EXH     | <b>VV3P5-41</b><br>   | 2 to 20 stations                          |
|        | Individual EXH | <b>VV3P5-42</b><br>  |   |
| VP700  | Common EXH     | <b>VV3P7-41</b><br> | 2 to 20 stations                          |
|        | Individual EXH | <b>VV3P7-42</b><br> |   |

(Note) Supply pressure to 1(P) ports and exhaust air from 3(R) ports on both sides for 10 stations or more.

Solenoid valve  
Base mounted

P. 1282

SYJ

VQZ

VP

VG

VP3

# Rubber Seal 3 Port/Pilot Poppet Type Body Ported/Single Unit VP300/500/700 Series



Note) Only DIN and conduit terminal types are available for AC mode.  
Refer to the electrical entry for details.

## How to Order

Body ported

VP **3** **4** **2** **5** **G** **1** - **01** **A** - -

### Series

|   |       |
|---|-------|
| 3 | VP300 |
| 5 | VP500 |
| 7 | VP700 |

### Pilot type

|     |                |
|-----|----------------|
| Nil | Internal pilot |
| R   | External pilot |

### Pressure specification

|     |                              |
|-----|------------------------------|
| Nil | Standard (0.7 MPa)           |
| K   | High-pressure type (1.0 MPa) |

### Coil specification

|     |                                     |
|-----|-------------------------------------|
| Nil | Standard                            |
| T   | With power saving circuit (DC only) |

Note) Be sure to select the power saving circuit type when it is continuously energized for a long time.  
(Refer to page 1296 for details.)

\* T type is only available for DC mode.

When T is selected, only Z type of light/surge voltage suppressor is available.

(Note that when the electrical entry of DIN terminal type without connector is selected, only DOS and YOS are available.)

### Rated voltage

| DC |        |
|----|--------|
| 5  | 24 VDC |
| 6  | 12 VDC |

### AC (50/60 Hz)

|   |                   |
|---|-------------------|
| 1 | 100 VAC           |
| 2 | 200 VAC           |
| 3 | 110 VAC [115 VAC] |
| 4 | 220 VAC [230 VAC] |
| 7 | 240 VAC           |
| B | 24 VAC            |

### Thread type

|     |      |
|-----|------|
| Nil | Rc   |
| F   | G    |
| N   | NPT  |
| T   | NPTF |

### Bracket

|     |                 |
|-----|-----------------|
| Nil | Without bracket |
| F   | With bracket    |

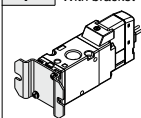

### Type of actuation

|   |                        |
|---|------------------------|
| A | N.C. (Normally closed) |
| B | N.O. (Normally open)   |

### Port size

| Symbol | Port size | VP300 | VP500 | VP700 |
|--------|-----------|-------|-------|-------|
| 01     | 1/8       | ○     | —     | —     |
| 02     | 1/4       | ○     | ○     | —     |
| 03     | 3/8       | —     | ○     | ○     |
| 04     | 1/2       | —     | —     | ○     |

### Made to Order

|      |  |
|------|--|
| Nil  | —  |
| X500 | Pilot exhaust port with piping thread (M3) specification (Refer to page 1291).                       |
| X505 | Interchangeable specification with the previous valve mounting hole pitch type (Refer to page 1291). |
| X600 | Triac output specification (Refer to page 1291).   |

### Electrical entry

| Grommet  | L-type plug connector             | M-type plug connector             | DIN terminal          | DIN (EN175301-803) terminal | Conduit terminal    |
|--|-----------------------------------|-----------------------------------|-----------------------|-----------------------------|---------------------|
|  |                                   |                                   |                       |                             |                     |
| G: Lead wire length 300 mm<br>H: Lead wire length 600 mm   | L: With lead wire (length 300 mm) | M: With lead wire (length 300 mm) | D: With connector     | Y: With connector           | T: Conduit terminal |
|  |                                   |                                   |                       |                             |                     |
| G: Lead wire length 300 mm<br>H: Lead wire length 600 mm<br>DC<br>Without light/surge voltage suppressor | LN: Without lead wire             | MN: Without lead wire             | DO: Without connector | YO: Without connector       |                     |
| CE-compliant   | DC                                | CE                                | CE                    | CE                          | CE                  |
| AC <sup>*)</sup>   | —                                 | —                                 | —                     | —                           | —                   |

### Manual override

| Nil: Non-locking push type | D: Push-turn locking slotted type | E: Push-turn locking lever type |
|----------------------------|-----------------------------------|---------------------------------|
|                            |                                   |                                 |

### Light/surge voltage suppressor

|     | DC  | AC         |
|-----|---|------------|
| Nil | Without light/surge voltage suppressor          | ○ ○        |
| S   | With surge voltage suppressor                   | ○ ○ (Note) |
| Z   | With light/surge voltage suppressor             | ○ ○        |
| R   | With surge voltage suppressor (Non-polar)       | ○ —        |
| U   | With light/surge voltage suppressor (Non-polar) | ○ —        |

Note) There is no S option for AC mode, since a rectifier prevents surge voltage generation.

\* In the DIN terminal type, since a light is installed in the connector, DOZ, DOU, YOZ, YOU are not available.

### Caution

When using the surge voltage suppressor type, residual voltage will remain. Refer to page 1300 for details.

\* LN and MN types are with 2 sockets.

\* Refer to page 1294 when different length of lead wire for L/M-type plug connector is required.

\* Refer to page 1295 for details on the DIN (EN175301-803) terminal.

Note) With the same specifications as the DC type, all lead wire entries for the 24 VAC type are CE marking compliant.

# Pilot Poppet Type Body Ported/Single Unit **VP300/500/700 Series**

Low power consumption 1.5 W (DC)

Possible to use as either a selector or divider valve

Possible to change from N.C. to N.O.

• Refer to page 1300 for changing the type of actuation.

Possible to use in vacuum applications

Up to -100 kPa



VP300 Series



VP500 Series



VP700 Series

## External Pilot

Use external pilot type in the following cases:

- For vacuum or for low pressure 0.2 MPa or less
- Since this valve has slight air leakage, it can not be used for holding vacuum (including positive pressure holding) in the pressure container.
- When having P port downsized in diameter
- When using A port as the atmospheric releasing port, e.g. air blow



**Made to Order**

(Refer to page 1291 for details.)

|      |  |
|------|--|
| X500 | Pilot exhaust port with piping thread (M3) specification                       |
| X505 | Interchangeable specification with the previous valve mounting hole pitch type |
| X600 | Triac output specification   |

## Specifications

|   |                    |   |
|---|--------------------|---|
| Fluid   |                    | Air   |
| Type of actuation   |                    | N.C. or N.O. (Convertible)  |
| Internal pilot<br>Operating pressure range (MPa)                | Standard           | 0.2 to 0.7  |
|   | High-pressure type | 0.2 to 1.0  |
| External pilot<br>Operating pressure range (MPa)                | Standard           | -100 kPa to 0.7   |
|   | High-pressure type | -100 kPa to 1.0   |
| Pilot pressure range  |                    | Same as operating pressure (Min. 0.2 MPa)   |
| Ambient and fluid temperature (°C)                              |                    | -10 to 50 (No freezing)   |
| Max. operating frequency (Hz)                                   |                    | 5   |
| Manual override   |                    | Non-locking push type<br>Push-turn locking slotted type<br>Push-turn locking lever type |
| Pilot exhaust type  |                    | Individual exhaust  |
| Lubrication   |                    | Not required  |
| Mounting orientation  |                    | Unrestricted  |
| Impact/Vibration resistance (m/s <sup>2</sup> ) <sup>Note</sup> |                    | 300/50  |
| Enclosure   |                    | Dust-tight (IP65 for D, Y, T)   |

Note) Impact resistance: No malfunction occurred when it is tested in the axial direction and at the right angles to the main valve and armature in both energized and de-energized states every once for each condition. (Values at the initial period)

Vibration resistance: No malfunction occurred in a one-sweep test between 45 and 2000 Hz. Test was performed at both energized and de-energized states in the axial direction and at the right angles to the main valve and armature. (Values at the initial period)

## Solenoid Specifications

|  |  |                             |   |                        |
|--|--|-----------------------------|---|------------------------|
| Electrical entry   | Grommet (G), (H)<br>L-type plug connector (L)<br>M-type plug connector (M) |                             | DIN terminal (D)<br>DIN (EN175301-803) terminal (Y)<br>Conduit terminal (T) |                        |
|  | G, H, L, M   |                             | D, Y, T   |                        |
| Coil rated voltage (V)   | DC   | 24, 12                      |   |                        |
|  | AC (50/60 Hz)  | 24, 100, 110, 200, 220, 240 |   |                        |
| Allowable voltage fluctuation<br>±10% of rated voltage*                  |  |                             |   |                        |
| Power consumption (W)  | DC   | Standard                    | 1.5 (With light: 1.55)  |                        |
|  |  | With power saving circuit   | 0.55 <sup>Note)</sup> (With light only)<br>[Starting 1.55, Holding 0.55]    |                        |
| Apparent power (VA) <sup>†</sup>   | AC   | 24 V                        | 1.5 (With light: 1.55)  |                        |
|  |  | 100 V                       | 1.55 (With light: 1.65)   |                        |
|  |  | 110 V [115 V]               |   |                        |
|  |  | 200 V                       |   | 1.55 (With light: 1.7) |
|  |  | 220 V [230 V]               |   |                        |
|  |  | 240 V                       |   |                        |
| Standard   | 1.5 (With light: 1.75)   |                             |   |                        |
| 0.75 <sup>Note)</sup> (With light only)<br>[Starting 1.75, Holding 0.75] |  |                             |   |                        |

Surge voltage suppressor Diode (Non-polar type: Varistor)

Indicator light LED (Neon bulb is used for AC mode of D, Y, T.)

\* It is in common between 110 VAC and 115 VAC, and between 220 VAC and 230 VAC.

\* Allowable voltage fluctuation is -15% to +5% of the rated voltage for 115 VAC or 230 VAC.

\* Since voltage drops due to the internal circuit in S, Z, T types (with power saving circuit), the allowable voltage fluctuation should be within the following range.

24 VDC: -7% to +10%

12 VDC: -4% to +10%

Note) Refer to page 1296 for details.

## Response Time

| Model | Pressure specifications         | Response time ms (at 0.5 MPa)          |                                     |            |            |
|-------|---------------------------------|--|-------------------------------------|------------|------------|
|       |                                 | Without light/surge voltage suppressor | With light/surge voltage suppressor |            | AC         |
|       |                                 | S, Z type                              | R, U type                           |            |            |
| VP342 | Standard (0.2 to 0.7)           | 13 or less                             | 38 or less                          | 16 or less | 38 or less |
|       | High-pressure type (0.2 to 1.0) | 17 or less                             | 42 or less                          | 20 or less | 42 or less |
| VP542 | Standard (0.2 to 0.7)           | 14 or less                             | 39 or less                          | 17 or less | 39 or less |
|       | High-pressure type (0.2 to 1.0) | 18 or less                             | 43 or less                          | 21 or less | 43 or less |
| VP742 | Standard (0.2 to 0.7)           | 19 or less                             | 44 or less                          | 22 or less | 44 or less |
|       | High-pressure type (0.2 to 1.0) | 22 or less                             | 47 or less                          | 25 or less | 47 or less |

Note) Based on dynamic performance test, JIS B 8419: 2010. (Coil temperature: 20°C, at rated voltage)

# VP300/500/700 Series

## Flow Rate Characteristics/Weight

| Model | Port size | 1 ↔ 2 (P ↔ A)                |      |     | 2 ↔ 3 (A ↔ R)                |      |     | Weight (g) <sup>Note)</sup> |              |
|-------|-----------|------------------------------|------|-----|------------------------------|------|-----|-----------------------------|--------------|
|       |           | C [dm <sup>3</sup> /(s·bar)] | b    | Cv  | C [dm <sup>3</sup> /(s·bar)] | b    | Cv  | Grommet                     | DIN terminal |
| VP342 | 1/8       | 3.5                          | 0.26 | 0.8 | 3.6                          | 0.26 | 0.9 | 149                         | 185          |
|       | 1/4       | 4.2                          | 0.22 | 1.0 | 4.2                          | 0.23 | 1.0 | 145                         | 181          |
| VP542 | 1/4       | 7.9                          | 0.21 | 1.8 | 7.2                          | 0.27 | 1.8 | 249                         | 285          |
|       | 3/8       | 8.9                          | 0.16 | 2.2 | 8.9                          | 0.20 | 2.1 | 241                         | 277          |
| VP742 | 3/8       | 11.9                         | 0.21 | 2.7 | 11.8                         | 0.20 | 2.7 | 484                         | 520          |
|       | 1/2       | 15.1                         | 0.21 | 3.6 | 15.3                         | 0.22 | 3.7 | 467                         | 503          |

Note) Values without bracket

## Application Example

### (1) Blow-off valve

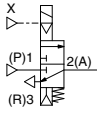

External pilot

### (2) Pressure release valve

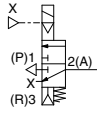

External pilot

### (3) Selector valve

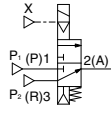

External pilot

### (4) Valve for vacuum

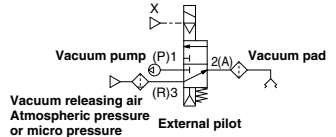

### (5) Divider valve

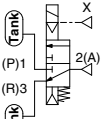

External pilot

### (6) Single-acting cylinder drive

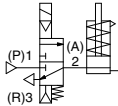

### (7) Double-acting cylinder drive

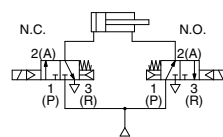

### (8) Double-acting cylinder drive (Exhaust center)

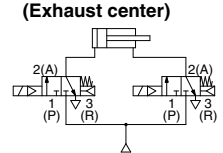

## Construction

### Body ported

#### Symbol

| Pilot type     | N.C. | N.O. |
|----------------|------|------|
| Internal pilot |      |      |
| External pilot |      |      |

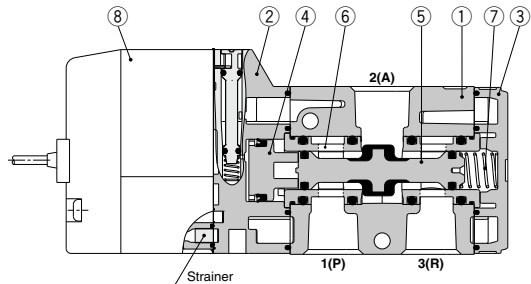

### Component Parts

| No. | Description   | Material            | Note  |
|-----|---------------|---------------------|-------|
| 1   | Body          | Aluminum die-casted | White |
| 2   | Adapter plate | Resin               | Gray  |
| 3   | End plate     | Resin               | White |
| 4   | Piston        | Resin               |       |
| 5   | Poppet valve  | Aluminum/HNBR       |       |
| 6   | Retainer      | Resin               |       |
| 7   | Spring        | Stainless steel     |       |

### Bracket Assembly Part No.

| Description                | Model | Part no.     |
|----------------------------|-------|--------------|
| Bracket<br>(With 2 screws) | VP342 | VP300-227-1A |
|                            | VP542 | VP500-227-1A |
|                            | VP742 | VP700-227-1A |

### Replacement Parts

| No. | Description          | Part no.   | Note              |
|-----|----------------------|--|-------------------|
| 8   | Pilot valve assembly | Refer to "How to Order Pilot Valve Assembly" on page 1267. | Built-in strainer |

## How to Order Pilot Valve Assembly

### ⚠ Caution

When only the pilot valve assembly is replaced, it is not possible to change from V211 (Grommet or L/M-type) to V212 (DIN or Conduit type), or vice versa.

Valve model: **VP**     - **5** **G** **Z**  **1** -

\* Select from the below in accordance with the valve used.

#### ■ Grommet or L/M-type

**V 2 1 1**   - **5** **G** **Z**

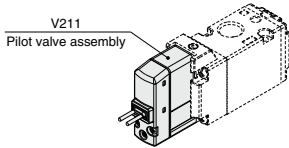

#### ● Light/surge voltage suppressor

|            |   | DC                    | AC                    |
|------------|---|-----------------------|-----------------------|
| <b>Nil</b> | Without light/surge voltage suppressor          | <input type="radio"/> | <input type="radio"/> |
| <b>S</b>   | With surge voltage suppressor                   | <input type="radio"/> | <input type="radio"/> |
| <b>Z</b>   | With light/surge voltage suppressor             | <input type="radio"/> | <input type="radio"/> |
| <b>R</b>   | With surge voltage suppressor (Non-polar)       | <input type="radio"/> | <input type="radio"/> |
| <b>U</b>   | With light/surge voltage suppressor (Non-polar) | <input type="radio"/> | <input type="radio"/> |

Note) There is no S option for AC mode, since a rectifier prevents surge voltage generation. When T is selected, only Z type of light/surge voltage suppressor is available.

### ⚠ Caution

When using the surge voltage suppressor type, residual voltage will remain. Refer to page 1300 for details.

#### ● Electrical entry

|           |                                   |                   |
|-----------|-----------------------------------|-------------------|
| <b>G</b>  | Grommet (Lead wire length 300 mm) |                   |
| <b>H</b>  | Grommet (Lead wire length 600 mm) |                   |
| <b>L</b>  | L-type plug connector             | With lead wire    |
| <b>LN</b> | L-type plug connector             | Without lead wire |
| <b>LO</b> | Without connector                 |                   |
| <b>M</b>  | M-type plug connector             | With lead wire    |
| <b>MN</b> | M-type plug connector             | Without lead wire |
| <b>MO</b> | Without connector                 |                   |

\* LN and MN types are with 2 sockets.

\* Refer to page 1294 when different length of lead wire for L/M-type plug connector is required.

#### ■ DIN or Conduit type

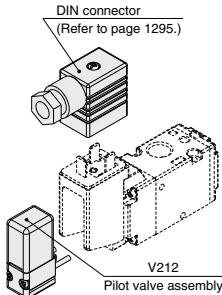

**V 2 1 2**   - **5**

#### ● Pressure specification

|            |                              |
|------------|------------------------------|
| <b>Nil</b> | Standard (0.7 MPa)           |
| <b>K</b>   | High-pressure type (1.0 MPa) |

#### ● Coil specification

|            |                                     |
|------------|-------------------------------------|
| <b>Nil</b> | Standard                            |
| <b>T</b>   | With power saving circuit (DC only) |

\* T type is only available for DC mode.

#### ● Rated voltage

##### DC

|          |        |
|----------|--------|
| <b>5</b> | 24 VDC |
| <b>6</b> | 12 VDC |

##### AC (50/60 Hz)

|          |                   |
|----------|-------------------|
| <b>1</b> | 100 VAC           |
| <b>2</b> | 200 VAC           |
| <b>3</b> | 110 VAC [115 VAC] |
| <b>4</b> | 220 VAC [230 VAC] |
| <b>7</b> | 240 VAC           |
| <b>B</b> | 24 VAC            |

### ⚠ Caution

For V212 (DIN or Conduit type), the coil specification and voltage (including light/surge voltage suppressor) cannot be changed by changing the pilot valve assembly.

### ⚠ Caution

Tightening torque of the pilot valve assembly mounting screw  
M2.5: 0.32 N·m

# VP300/500/700 Series

## VP300 Series/Body Ported/Dimensions

### Grommet (G)

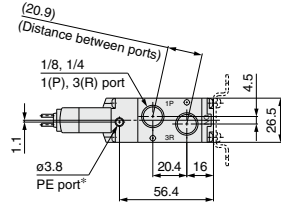
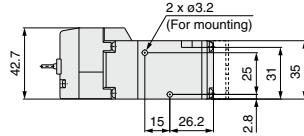
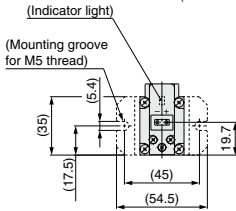
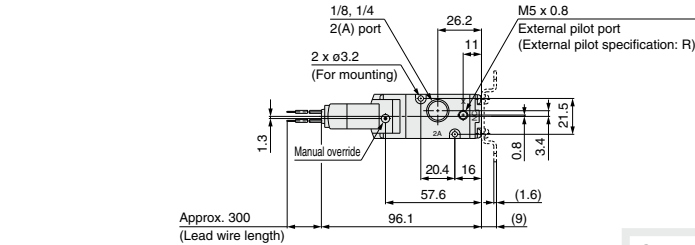

\* Refer to page 1291 separately when piping to PE port is required.

### Grommet (G) DC without light/surge voltage suppressor

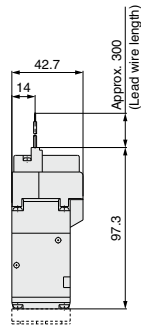

### L-type plug connector (L)

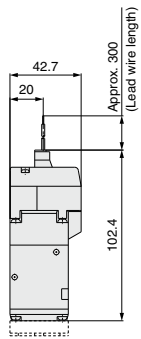

### M-type plug connector (M)

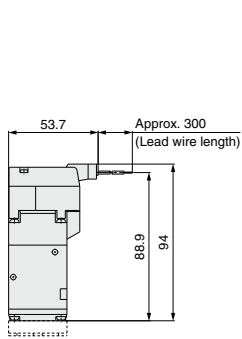

### DIN terminal (D, Y)

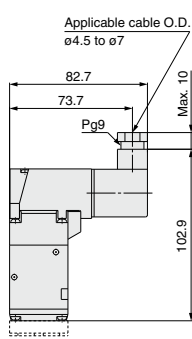

### Conduit terminal (T)

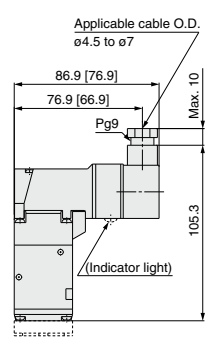

[ ] : Without indicator light



# Pilot Poppet Type Body Ported/Single Unit **VP300/500/700 Series**

## VP500 Series/Body Ported/Dimensions

### Grommet (G)

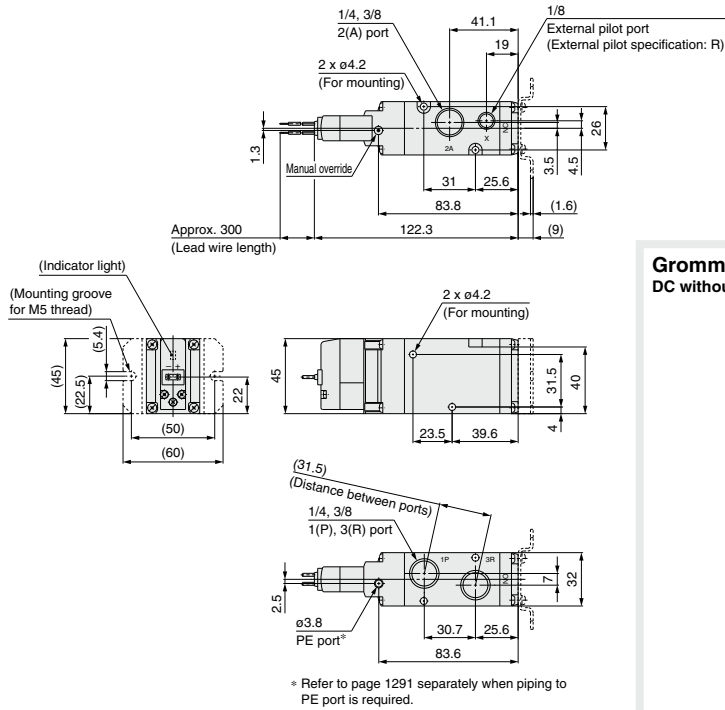

### Grommet (G) DC without light/surge voltage suppressor

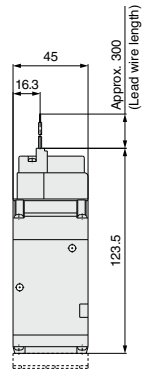

### L-type plug connector (L)

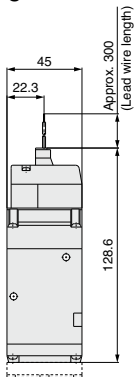

### M-type plug connector (M)

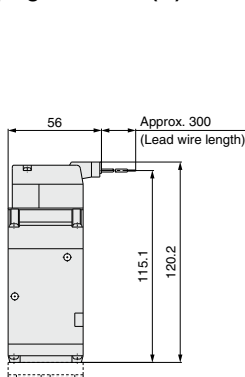

### DIN terminal (D, Y)

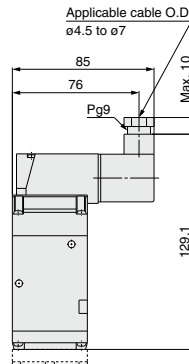

### Conduit terminal (T)

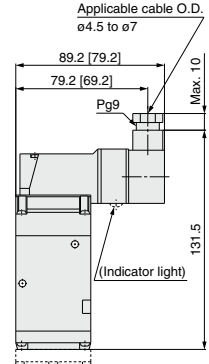

[ ]: Without indicator light

SYJ

VQZ

VP

VG

VP3

Unless otherwise indicated, dimensions are the same as Grommet (G).

# VP300/500/700 Series

## VP700 Series/Body Ported/Dimensions

### Grommet (G)

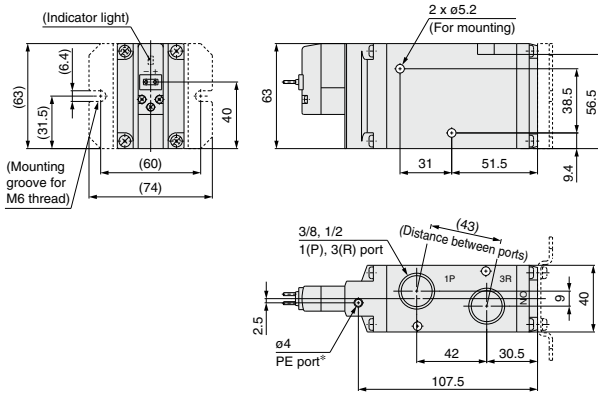
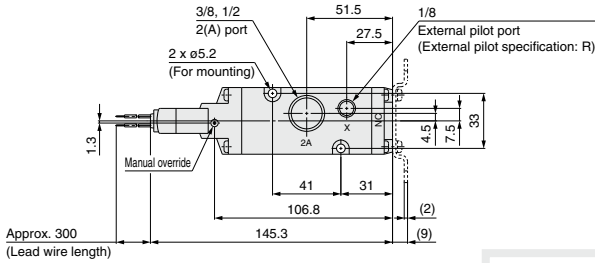

\* Refer to page 1291 separately when piping to PE port is required.

### Grommet (G) DC without light/surge voltage suppressor

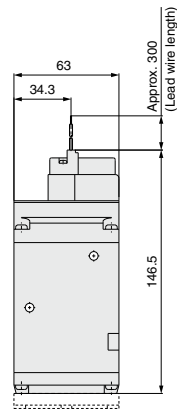

### L-type plug connector (L)

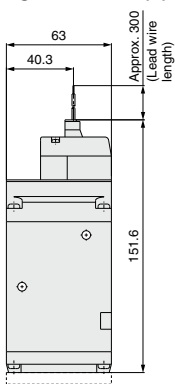

### M-type plug connector (M)

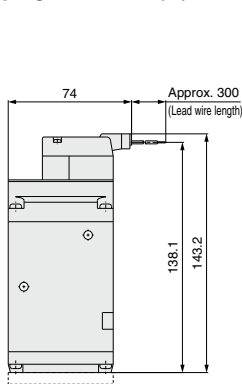

### DIN terminal (D, Y)

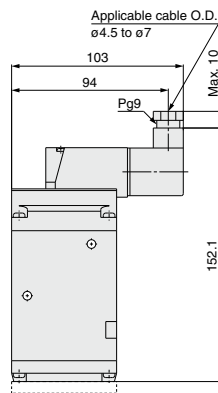

### Conduit terminal (T)

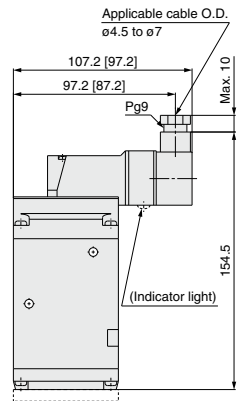

[ ] : Without indicator light

Unless otherwise indicated, dimensions are the same as Grommet (G).

# Rubber Seal 3 Port/Pilot Poppet Type Base Mounted/Single Unit VP300/500/700 Series



Note) Only DIN and conduit terminal types are available for AC mode.  
Refer to the electrical entry for details.

## How to Order

Base mounted

VP 3 4 4 - 5 G 1 - A -

### Series

|   |       |
|---|-------|
| 3 | VP300 |
| 5 | VP500 |
| 7 | VP700 |

### Pilot type

|     |                |
|-----|----------------|
| Nil | Internal pilot |
| R   | External pilot |

### Pressure specification

|     |                              |
|-----|------------------------------|
| Nil | Standard (0.7 MPa)           |
| K   | High-pressure type (1.0 MPa) |

### Coil specification

|     |                                     |
|-----|-------------------------------------|
| Nil | Standard                            |
| T   | With power saving circuit (DC only) |

Note) Be sure to select the power saving circuit type when it is continuously energized for a long time.

(Refer to page 1296 for details.)

\* T type is only available for DC mode.

When T is selected, only Z type of light/surge voltage suppressor is available.

(Note that when the electrical entry of DIN terminal type without connector is selected, only DOS and YOS are available.)

### Rated voltage

| DC |        |
|----|--------|
| 5  | 24 VDC |
| 6  | 12 VDC |

### AC (50/60 Hz)

|   |                   |
|---|-------------------|
| 1 | 100 VAC           |
| 2 | 200 VAC           |
| 3 | 110 VAC [115 VAC] |
| 4 | 220 VAC [230 VAC] |
| 7 | 240 VAC           |
| B | 24 VAC            |

### Type of actuation

|   |                        |
|---|------------------------|
| A | N.C. (Normally closed) |
| B | N.O. (Normally open)   |

### Thread type

|     |      |
|-----|------|
| Nil | Rc   |
| F   | G    |
| N   | NPT  |
| T   | NPTF |

### Made to Order

|      |  |
|------|--|
| Nil  | —  |
| X500 | Pilot exhaust port with piping thread (M3) specification (Refer to page 1291). |
| X600 | Triac output specification (Refer to page 1291).                               |

### Port size (Sub-plate)

| Symbol | Port size          | VP300 | VP500 | VP700 |
|--------|--------------------|-------|-------|-------|
| Nil    | Without sub-plate* | —     | —     | —     |
| 01     | 1/8                | ○     | —     | —     |
| 02     | 1/4                | ○     | ○     | —     |
| 03     | 3/8                | —     | ○     | ○     |
| 04     | 1/2                | —     | —     | ○     |

\* With a gasket and two mounting bolts.

### Electrical entry

| Grommet  | L-type plug connector             | M-type plug connector             | DIN terminal (IP65 compatible) | DIN (EN175301-803) terminal (IP65 compatible) | Conduit terminal (IP65 compatible) |
|--|-----------------------------------|-----------------------------------|--------------------------------|---|------------------------------------|
|  |                                   |                                   |                                |   |                                    |
| G: Lead wire length 300 mm<br>H: Lead wire length 600 mm   | L: With lead wire (length 300 mm) | M: With lead wire (length 300 mm) | D: With connector              | Y: With connector                             | T: Conduit terminal                |
|  |                                   |                                   |                                |   |                                    |
| G: Lead wire length 300 mm<br>H: Lead wire length 600 mm<br>DC<br>Without light/surge voltage suppressor | LN: Without lead wire             | MN: Without lead wire             | DO: Without connector          | YO: Without connector                         |                                    |
|  |                                   |                                   |                                |   |                                    |
| LO: Without connector  | MO: Without connector             |                                   |                                |   |                                    |
| CE-compliant   | DC                                | CE                                | CE                             | CE  | CE                                 |
|  | AC <sup>(10)</sup>                | —                                 | —                              | —   | —                                  |

### Manual override

| Nil: Non-locking push type | D: Push-turn locking slotted type | E: Push-turn locking lever type |
|----------------------------|-----------------------------------|---------------------------------|
|                            |                                   |                                 |

### Light/surge voltage suppressor

|     | DC  | AC    |
|-----|---|-------|
| Nil | Without light/surge voltage suppressor          | ○ (—) |
| S   | With surge voltage suppressor                   | ○ (—) |
| Z   | With light/surge voltage suppressor             | ○ (—) |
| R   | With surge voltage suppressor (Non-polar)       | ○ (—) |
| U   | With light/surge voltage suppressor (Non-polar) | ○ (—) |

Note) There is no S option for AC mode, since a rectifier prevents surge voltage generation.

\* In the DIN terminal type, since a light is installed in the connector, DOZ, DOU, YOZ, YOU are not available.

### Caution

When using the surge voltage suppressor type, residual voltage will remain. Refer to page 1300 for details.

\* LN and MN types are with 2 sockets.

\* Refer to page 1294 when different length of lead wire for L/M-type plug connector is required.

\* Refer to page 1295 for details on the DIN (EN175301-803) terminal.

Note) With the same specifications as the DC type, all lead wire entries for the 24 VAC type are CE marking compliant.

# VP300/500/700 Series

Low power consumption 1.5 W (DC)

Possible to use as either a selector or divider valve

Possible to change from N.C. to N.O.

- Refer to page 1300 for changing the type of actuation.

Possible to use in vacuum applications

Up to -100 kPa

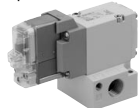

VP300 Series



VP500 Series



VP700 Series

## External Pilot

Use external pilot type in the following cases:

- For vacuum or for low pressure 0.2 MPa or less
- Please consult with SMC for use in a vacuum hold application.
- When having P port downsized in diameter
- When using A port as the atmospheric releasing port, e.g. air blower
- If manifold, external pilot piping can be centralized in manifold base.



**Made to Order**  
(Refer to page 1291 for details.)

|      |  |
|------|--|
| X500 | Pilot exhaust port with piping thread (M3) specification |
| X600 | Triac output specification                               |

## Specifications

|   |                      |   |
|---|----------------------|---|
| Fluid   |                      | Air   |
| Type of actuation   |                      | N.C. or N.O. (Convertible)  |
| Internal pilot<br>Operating pressure range (MPa)                | Standard             | 0.2 to 0.7  |
|   | High-pressure type   | 0.2 to 1.0  |
| External pilot<br>Operating pressure range (MPa)                | Standard             | -100 kPa to 0.7   |
|   | High-pressure type   | -100 kPa to 1.0   |
|   | Pilot pressure range | Same as operating pressure (Min. 0.2 MPa)   |
| Ambient and fluid temperature (°C)                              |                      | -10 to 50 (No freezing)   |
| Max. operating frequency (Hz)                                   |                      | 5   |
| Manual override   |                      | Non-locking push type<br>Push-turn locking slotted type<br>Push-turn locking lever type |
| Pilot exhaust type  |                      | Individual exhaust  |
| Lubrication   |                      | Not required  |
| Mounting orientation  |                      | Unrestricted  |
| Impact/Vibration resistance (m/s <sup>2</sup> ) <sup>Note</sup> |                      | 300/50  |
| Enclosure   |                      | Dust-tight (IP65 for D, Y, T)   |

Note) Impact resistance: No malfunction occurred when it is tested in the axial direction and at the right angles to the main valve and armature in both energized and de-energized states every once for each condition. (Values at the initial period)

Vibration resistance: No malfunction occurred in a one-sweep test between 45 and 2000 Hz. Test was performed at both energized and de-energized states in the axial direction and at the right angles to the main valve and armature. (Values at the initial period)

## Solenoid Specifications

|                                  |                             |  |   |
|----------------------------------|-----------------------------|--|---|
| Electrical entry                 |                             | Grommet (G), (H)   | DIN terminal (D)  |
|                                  |                             | L-type plug connector (L)<br>M-type plug connector (M)   | DIN (EN175301-803) terminal (Y)<br>Conduit terminal (T)   |
| Coil rated voltage (V)           |                             | 24, 12   |   |
| DC                               | 24, 100, 110, 200, 220, 240 |  |   |
| AC (50/60 Hz)                    | 24, 100, 110, 200, 220, 240 |  |   |
| Allowable voltage fluctuation    |                             | ±10% of rated voltage*   |   |
| Power consumption (W)            | DC                          | Standard<br>1.5 (With light: 1.55)<br>With power saving circuit<br>0.55 <sup>Note</sup> (With light only)<br>[Starting 1.55, Holding 0.55] | 1.5 (With light: 1.75)<br>0.75 <sup>Note</sup> (With light only)<br>[Starting 1.75, Holding 0.75] |
|                                  | AC                          | 24 V<br>100 V<br>110 V [115 V]<br>200 V<br>220 V [230 V]<br>240 V  | 1.5 (With light: 1.75)<br>1.55 (With light: 1.65)<br>1.55 (With light: 1.7)                       |
| Apparent power (VA) <sup>*</sup> |                             |  |   |
| Surge voltage suppressor         |                             | Diode (Non-polar type: Varistor)   |   |
| Indicator light                  |                             | LED (Neon bulb is used for AC mode of D, Y, T.)  |   |

\* It is in common between 110 VAC and 115 VAC, and between 220 VAC and 230 VAC.

\* Allowable voltage fluctuation is -15% to +5% of the rated voltage for 115 VAC or 230 VAC.

\* Since voltage drops due to the internal circuit in S, Z, T types (with power saving circuit), the allowable voltage fluctuation should be within the following range.

24 VDC: -7% to +10%

12 VDC: -4% to +10%

Note) Refer to page 1296 for details.

## Response Time

| Model | Pressure specifications         | Response time ms (at 0.5 MPa)          |                                     |            |            |
|-------|---------------------------------|--|-------------------------------------|------------|------------|
|       |                                 | Without light/surge voltage suppressor | With light/surge voltage suppressor |            | AC         |
|       |                                 | S, Z type                              | R, U type                           |            |            |
| VP344 | Standard (0.2 to 0.7)           | 13 or less                             | 38 or less                          | 16 or less | 38 or less |
|       | High-pressure type (0.2 to 1.0) | 17 or less                             | 42 or less                          | 20 or less | 42 or less |
| VP544 | Standard (0.2 to 0.7)           | 14 or less                             | 39 or less                          | 17 or less | 39 or less |
|       | High-pressure type (0.2 to 1.0) | 18 or less                             | 43 or less                          | 21 or less | 43 or less |
| VP744 | Standard (0.2 to 0.7)           | 19 or less                             | 44 or less                          | 22 or less | 44 or less |
|       | High-pressure type (0.2 to 1.0) | 22 or less                             | 47 or less                          | 25 or less | 47 or less |

Note) Based on dynamic performance test, JIS B 8374-1981. (Coil temperature: 20°C, at rated voltage)

# Pilot Poppet Type Base Mounted/Single Unit **VP300/500/700 Series**

## Flow Rate Characteristics/Weight

| Model | Port size | 1 ↔ 2 (P ↔ A)                |      |     | 2 ↔ 3 (A ↔ R)                |      |     | Weight (g) <sup>Note)</sup> |              |
|-------|-----------|------------------------------|------|-----|------------------------------|------|-----|-----------------------------|--------------|
|       |           | C [dm <sup>3</sup> /(s·bar)] | b    | Cv  | C [dm <sup>3</sup> /(s·bar)] | b    | Cv  | Grommet                     | DIN terminal |
| VP344 | 1/8       | 3.6                          | 0.22 | 0.8 | 3.5                          | 0.24 | 0.8 | 216 (149)                   | 252 (185)    |
|       | 1/4       | 3.9                          | 0.22 | 0.9 | 3.8                          | 0.14 | 0.9 | 211 (149)                   | 247 (185)    |
| VP544 | 1/4       | 7.5                          | 0.16 | 1.7 | 7.3                          | 0.20 | 1.7 | 370 (245)                   | 406 (281)    |
|       | 3/8       | 8.8                          | 0.07 | 2.0 | 8.8                          | 0.13 | 2.0 | 362 (245)                   | 398 (281)    |
| VP744 | 3/8       | 12.9                         | 0.10 | 2.9 | 13.3                         | 0.24 | 3.1 | 676 (459)                   | 712 (495)    |
|       | 1/2       | 14.7                         | 0.05 | 3.3 | 15.0                         | 0.17 | 3.4 | 658 (459)                   | 694 (495)    |

Note) ( ): Values without sub-plate

## Application Example

### (1) Blow-off valve

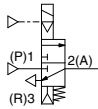

External pilot

### (2) Pressure release valve

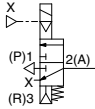

External pilot

### (3) Selector valve

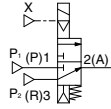

External pilot

### (4) Valve for vacuum

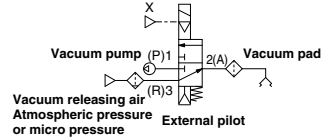

Vacuum pump  
Vacuum pad  
Vacuum releasing air  
Atmospheric pressure or micro pressure  
External pilot

### (5) Divider valve

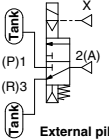

External pilot

### (6) Single-acting cylinder drive

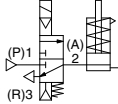

### (7) Double-acting cylinder drive

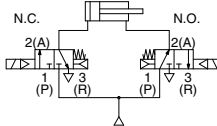

### (8) Double-acting cylinder drive (Exhaust center)

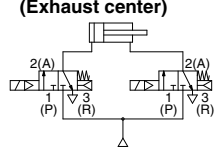

## Construction

### Base mounted

#### Symbol

| Pilot type     | N.C. | N.O. |
|----------------|------|------|
| Internal pilot |      |      |
| External pilot |      |      |

#### Component Parts

| No. | Description   | Material            | Note  |
|-----|---------------|---------------------|-------|
| 1   | Body          | Aluminum die-casted | White |
| 2   | Adapter plate | Resin               | Gray  |
| 3   | End plate     | Resin               | White |
| 4   | Piston        | Resin               |       |
| 5   | Poppet valve  | Aluminum/HNBR       |       |
| 6   | Retainer      | Resin               |       |
| 7   | Spring        | Stainless steel     |       |

#### Replacement Parts

| No. | Description                      | Part no.   |                       |                       | Note                |
|-----|----------------------------------|--|-----------------------|-----------------------|---------------------|
|     |                                  | VP344  | VP544                 | VP744                 |                     |
| 8   | Pilot valve assembly             | Refer to "How to Order Pilot Valve Assembly" on page 1274. |                       |                       | Built-in strainer   |
| 9   | Gasket                           | VP300-217-1  | VP500-217-1           | VP700-217-1           | HNBR                |
| 10  | Sub-plate                        | VP300-202-□  | VP500-202-□           | VP700-202-□           | Aluminum die-casted |
| —   | Hexagon socket head bolt (1 pc.) | VP300-224-1 (M3 x 36)                                      | VP500-224-1 (M4 x 46) | VP700-224-1 (M5 x 66) | For valve mounting  |

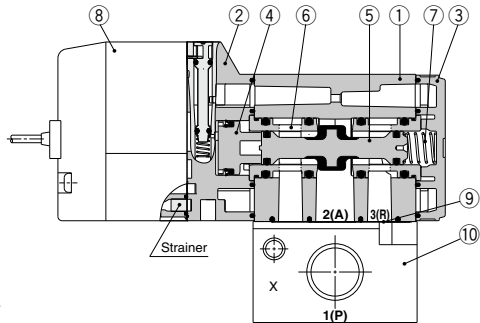

SYJ  
VQZ  
VP  
VG  
VP3

## How to Order Sub-plate

**VP 3 00-202-1**

#### Series

|   |       |
|---|-------|
| 3 | VP344 |
| 5 | VP544 |
| 7 | VP744 |

#### Thread type

|     |      |
|-----|------|
| Nil | Rc   |
| F   | G    |
| N   | NPT  |
| T   | NPTF |

### ⚠ Caution

**Tightening Torque of Mounting Screw**

M3: 0.8 N·m  
M4: 1.4 N·m  
M5: 2.9 N·m

#### Port size

| Symbol | VP344 | VP544 | VP744 |
|--------|-------|-------|-------|
| 1      | 1/8   | 1/4   | 3/8   |
| 2      | 1/4   | 3/8   | 1/2   |

Note) These specifications are common to the internal and external pilots.

# VP300/500/700 Series

## How to Order Pilot Valve Assembly

### ⚠ Caution

When only the pilot valve assembly is replaced, it is not possible to change from V211 (Grommet or L/M-type) to V212 (DIN or Conduit type), or vice versa.

Valve model: VP□□□□□□ - 5 G Z □ 1 - □□□□

\* Select from the below in accordance with the valve used.

#### ■ Grommet or L/M-type

V 2 1 1 □□ - 5 G Z

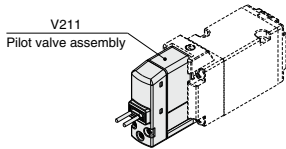

#### ● Light/surge voltage suppressor

|     |   | DC                    | AC                    |
|-----|---|-----------------------|-----------------------|
| Nil | Without light/surge voltage suppressor          | <input type="radio"/> | <input type="radio"/> |
| S   | With surge voltage suppressor                   | <input type="radio"/> | <input type="radio"/> |
| Z   | With light/surge voltage suppressor             | <input type="radio"/> | <input type="radio"/> |
| R   | With surge voltage suppressor (Non-polar)       | <input type="radio"/> | <input type="radio"/> |
| U   | With light/surge voltage suppressor (Non-polar) | <input type="radio"/> | <input type="radio"/> |

Note) There is no S option for AC mode, since a rectifier prevents surge voltage generation. When T is selected, only Z type of light/surge voltage suppressor is available.

### ⚠ Caution

When using the surge voltage suppressor type, residual voltage will remain. Refer to page 1300 for details.

#### ● Electrical entry

|    |                                   |                   |
|----|-----------------------------------|-------------------|
| G  | Grommet (Lead wire length 300 mm) |                   |
| H  | Grommet (Lead wire length 600 mm) |                   |
| L  | L-type plug connector             | With lead wire    |
| LN |                                   | Without lead wire |
| LO | Without connector                 |                   |
| M  | M-type plug connector             | With lead wire    |
| MN |                                   | Without lead wire |
| MO | Without connector                 |                   |

\* LN and MN types are with 2 sockets.

\* Refer to page 1294 when different length of lead wire for L/M-type plug connector is required.

#### ■ DIN or Conduit type

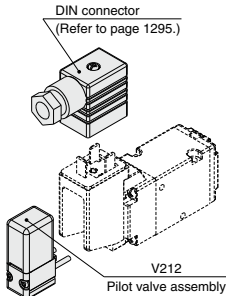

V 2 1 2 □□ - 5

#### ● Pressure specification

|     |                              |
|-----|------------------------------|
| Nil | Standard (0.7 MPa)           |
| K   | High-pressure type (1.0 MPa) |

#### ● Coil specification

|     |                                     |
|-----|-------------------------------------|
| Nil | Standard                            |
| T   | With power saving circuit (DC only) |

\* T type is only available for DC mode.

#### ● Rated voltage

| DC |        |
|----|--------|
| 5  | 24 VDC |
| 6  | 12 VDC |

#### AC (50/60 Hz)

|   |                   |
|---|-------------------|
| 1 | 100 VAC           |
| 2 | 200 VAC           |
| 3 | 110 VAC [115 VAC] |
| 4 | 220 VAC [230 VAC] |
| 7 | 240 VAC           |
| B | 24 VAC            |

### ⚠ Caution

For V212 (DIN or Conduit type), the coil specification and voltage (including light/surge voltage suppressor) cannot be changed by changing the pilot valve assembly.

### ⚠ Caution

Tightening torque of the pilot valve assembly mounting screw  
M2.5: 0.32 N·m

# Pilot Poppet Type Base Mounted/Single Unit **VP300/500/700 Series**

## VP300 Series/Base Mounted/Dimensions

### Grommet (G)

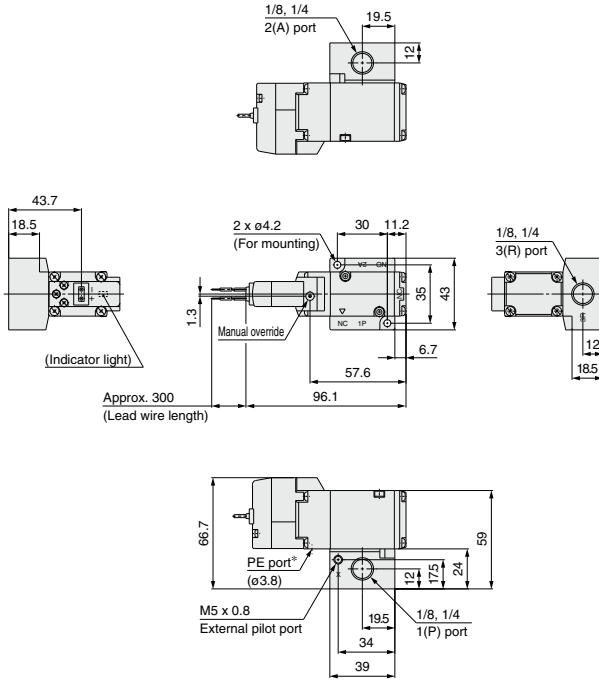

**Grommet (G)**  
DC without light/surge voltage suppressor

\* Refer to page 1291 separately when piping to PE port is required.

### L-type plug connector (L)

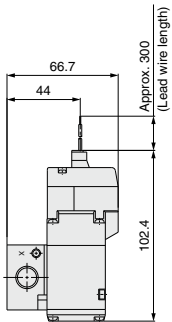

### M-type plug connector (M)

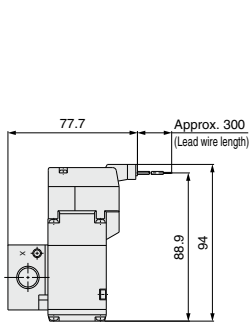

### DIN terminal (D, Y)

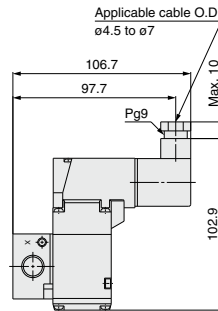

### Conduit terminal (T)

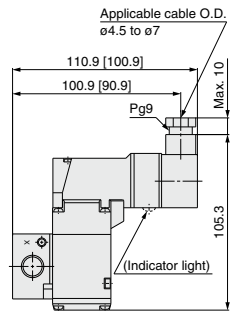

[ ]: Without indicator light

SYJ

VQZ

VP

VG

VP3

Unless otherwise indicated, dimensions are the same as Grommet (G).

# VP300/500/700 Series

## VP500 Series/Base Mounted/Dimensions

### Grommet (G)

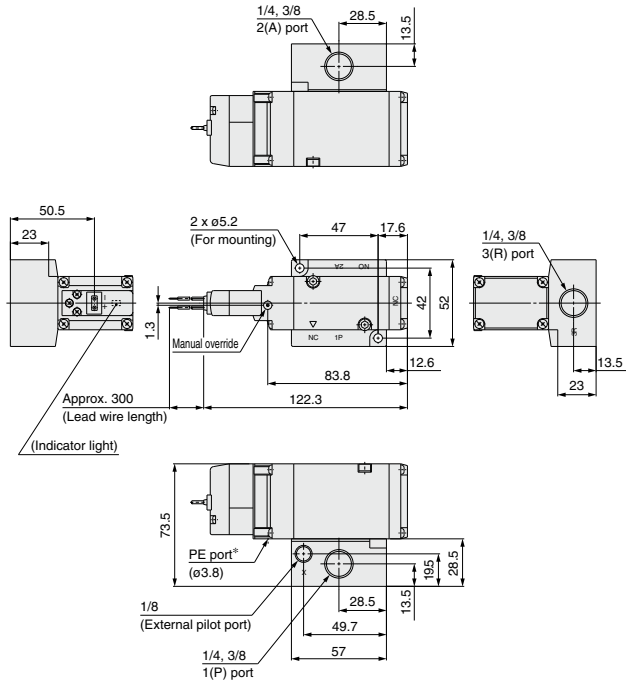

### Grommet (G) DC without light/surge voltage suppressor

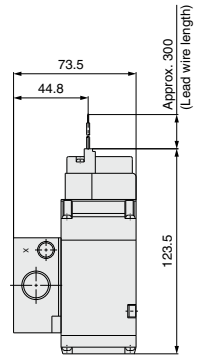

\* Refer to page 1291 separately when piping to PE port is required.

### L-type plug connector (L)

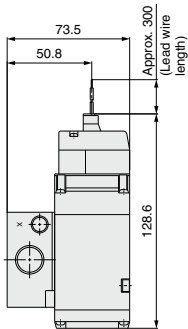

### M-type plug connector (M)

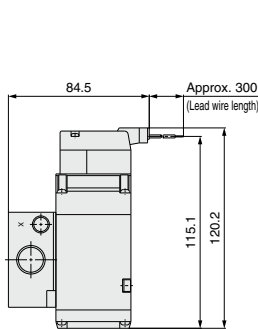

### DIN terminal (D, Y)

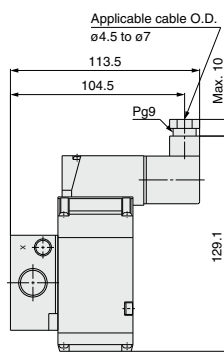

### Conduit terminal (T)

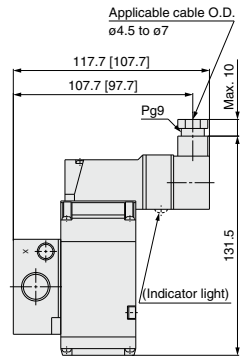

[ ] : Without indicator light





Body Ported  
Base Mounted

# Low Wattage Specification

RoHS

# VP300/500 Series

## How to Order Valve



Only DIN and conduit terminal types are available for AC mode.  
Refer to the electrical entry for details.

VP 3 4 2 R Y - 5 D Z E 1 - 02 T A - F

**Series**

|   |       |
|---|-------|
| 3 | VP300 |
| 5 | VP500 |

**Body type**

| Mountable manifold |              |
|--------------------|--------------|
| 2                  | Body ported  |
| 4                  | Base mounted |

Note) Refer to page 1282.

**Pilot type**

|     |                |
|-----|----------------|
| Nil | Internal pilot |
| R   | External pilot |

**Low wattage type**

**Rated voltage**

|   |         |
|---|---------|
| 1 | 100 VAC |
| 2 | 200 VAC |
| 3 | 110 VAC |
| 4 | 220 VAC |
| 5 | 24 VDC  |
| 6 | 12 VDC  |

**Bracket**

|     |                 |
|-----|-----------------|
| Nil | Without bracket |
| F   | With bracket*   |

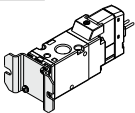

\* Body ported only

**Type of actuation**

|   |                       |
|---|-----------------------|
| A | N.C.(Normally closed) |
| B | N.O.(Normally open)   |

**Thread type**

|     |        |
|-----|--------|
| Nil | Rc, M5 |
| F   | G      |
| N   | NPT    |
| T   | NPTF   |

**Port size**

**Body Ported**

| Symbol | Port size | VP300 | VP500 |
|--------|-----------|-------|-------|
| 01     | 1/8       | ○     | —     |
| 02     | 1/4       | ○     | ○     |
| 03     | 3/8       | —     | ○     |

**Base Mounted**

| Symbol | Port size          | VP300 | VP500 |
|--------|--------------------|-------|-------|
| Nil    | Without sub-plate* | —     | —     |
| 01     | 1/8                | ○     | —     |
| 02     | 1/4                | ○     | ○     |
| 03     | 3/8                | —     | ○     |

\* With a gasket and two mounting bolts.

**Manual override**

|     |                                |
|-----|--------------------------------|
| Nil | Non-locking push type          |
| D   | Push-turn locking slotted type |
| E   | Push-turn locking lever type   |

**Electrical entry**

| 24 VDC, 12 VDC/100 VAC, 110 VAC, 200 VAC, 220 VAC |                                   |                                   |                       | 24 VDC, 12 VDC/100 VAC, 110 VAC, 200 VAC, 220 VAC |                                     |
|---|-----------------------------------|-----------------------------------|-----------------------|---|-------------------------------------|
| Grommet   |                                   | M-type plug connector             |                       | DIN terminal                                      |                                     |
| G: Lead wire length 300 mm                        | L: With lead wire (Length 300 mm) | M: With lead wire (Length 300 mm) | MN: Without lead wire | <IP65 compatible> D: With connector               | <IP65 compatible> Y: With connector |
|   |                                   |                                   |                       |   |                                     |
| H: Lead wire length 600 mm                        | LN: Without lead wire             | LO: Without connector             | MO: Without connector | DO: Without connector                             | YO: Without connector               |
|   |                                   |                                   |                       |   |                                     |
| DC  | ●                                 | ●                                 | ●                     | ●   | ●                                   |
| AC  | —                                 | —                                 | —                     | ●   | ●                                   |

\* LN and MN types are with 2 sockets.  
\* Y type DIN terminal complies with EN-175301-803C (former DIN 43650C). Refer to page 1299 for details.  
\* When using IP65, select the main/pilot valve common exhaust type. (Except VF1000)

**Light/Surge voltage suppressor and common specifications**

|     |  |                               |
|-----|--|-------------------------------|
| Nil | Without light/surge voltage suppressor                   | —                             |
| R   | With surge voltage suppressor (DC only, Non-polar)       | D and Y are not available     |
| U   | With light/surge voltage suppressor (DC only, Non-polar) | D and Y are not available     |
| S   | With surge voltage suppressor (DC only)                  | —                             |
| Z   | With light/surge voltage suppressor                      | DOZ and YOZ are not available |

## Specifications

|  |   |
|--|---|
| Fluid  | Air   |
| Type of actuation  | N.C. or N.O. (Convertible)  |
| Internal pilot operating pressure range (MPa)                        | 0.2 to 0.7  |
| External pilot operating pressure range (MPa)                        | -100 KPa to 0.7   |
| Pilot pressure range   | Equivalent to operating pressure (Min. 0.2)   |
| Ambient and fluid temperature (°C)                                   | -10 to 50 (No freezing)   |
| Max. operating frequency (Hz)  | 5   |
| Manual override  | Non-locking push type<br>Push-turn locking slotted type<br>Push-turn locking lever type |
| Pilot exhaust type   | Individual exhaust  |
| Lubrication  | Not required  |
| Mounting orientation   | Unrestricted  |
| Impact/Vibration resistance (m/s <sup>2</sup> ) <small>Note)</small> | 150/30  |
| Enclosure  | Dustproof (IP65 for D and Y)  |

Note) Impact resistance: No malfunction occurred when it is tested in the axial direction and at the right angles to the main valve and armature in both energized and de-energized states every once for each condition. (Values at the initial period)

Vibration resistance: No malfunction occurred in a one-sweep test between 45 and 2000 Hz. Test was performed at both energized and de-energized states in the axial direction and at the right angles to the main valve and armature. (Values at the initial period)

## Solenoid Specifications

|                                  |               |  |   |                           |
|----------------------------------|---------------|--|---|---------------------------|
| Electrical entry                 |               | Grommet (G), (H)<br>L-type plug connector (L)<br>M-type plug connector (M)<br>G, H, L, M | DIN terminal (D)<br>DIN (43650B) terminal (Y)<br>D, Y |                           |
| Coil rated voltage (V)           | DC            | 24, 12   |   |                           |
|                                  | AC (50/60 Hz) | 100, 110, 200, 220   |   |                           |
| Allowable voltage fluctuation    |               | ±10% of rated voltage*   |   |                           |
| Power consumption (W)            | DC            | 0.35 (With light: 0.4 (With light of DIN terminal: 0.45))                                |   |                           |
| Apparent power (VA) <sup>†</sup> | AC            | 100 V  | 0.78 (With light: 0.81)                               | 0.78 (With light: 0.87)   |
|                                  |               | 110 V  | 0.86 (With light: 0.89)                               | 0.86 (With light: 0.97)   |
|                                  |               | [115 V]  | [0.94 (With light: 0.97)]                             | [0.94 (With light: 1.07)] |
|                                  |               | 200 V  | 1.18 (With light: 1.22)                               | 1.15 (With light: 1.30)   |
|                                  |               | [230 V]  | [1.42 (With light: 1.46)]                             | [1.39 (With light: 1.60)] |
| Surge voltage suppressor         |               | Diode (DIN terminal, Non-polar type: Varistor)   |   |                           |
| Indicator light                  |               | LED (Neon bulb is used for AC mode of D and Y.)  |   |                           |

\* It is in common between 110 VAC and 115 VAC, and between 220 VAC and 230 VAC.

† Allowable voltage fluctuation is -15% to +5% of the rated voltage for 115 VAC or 230 VAC.

‡ Since voltage drops due to the internal circuit in S and Z types, the allowable voltage fluctuation should be within the following range.

24 VDC: -7% to +10%

12 VDC: -4% to +10%

## Response Time

| Series | Type of actuation | Response time ms (at 0.5 MPa)          |                                     |           |    | AC type |
|--------|-------------------|--|-------------------------------------|-----------|----|---------|
|        |                   | Without light/surge voltage suppressor | With light/surge voltage suppressor |           |    |         |
|        |                   |  | S, Z type                           | R, U type |    |         |
| VP300  | VP342Y            | 16                                     | 40                                  | 21        | 40 |         |
|        | VP344Y            | 16                                     | 40                                  | 21        | 40 |         |
| VP500  | VP542Y            | 31                                     | 45                                  | 36        | 44 |         |
|        | VP544Y            | 31                                     | 45                                  | 36        | 44 |         |

Note) Based on dynamic performance test, JIS B 8375-1981. (Coil temperature: 20°C, at rated voltage)

SYJ

VQZ

VP

VG

VP3

# VP300/500 Series

## Dimensions

### VP342Y

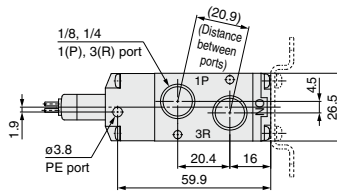
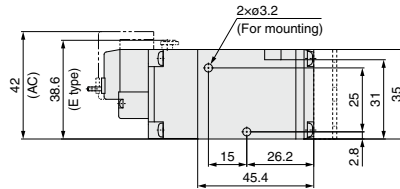
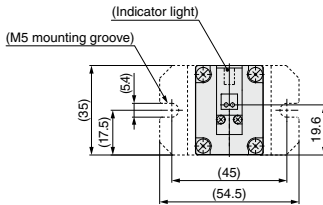
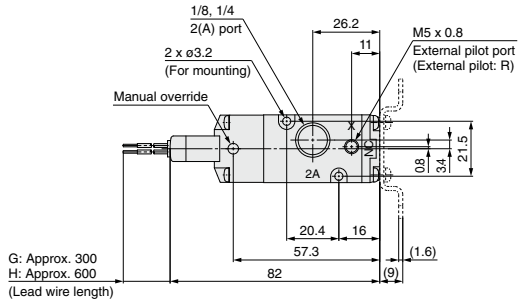

### L-type plug connector (L)

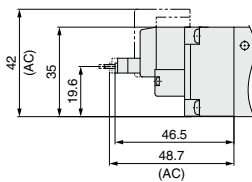

### M-type plug connector (M)

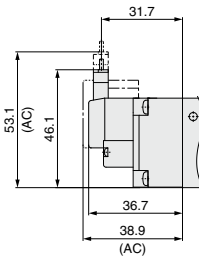

### DIN terminal (D,Y)

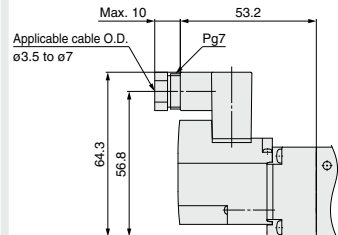

# Low Wattage Specification Body Ported/Base Mounted **VP300/500 Series**

## Dimensions

### VP542Y

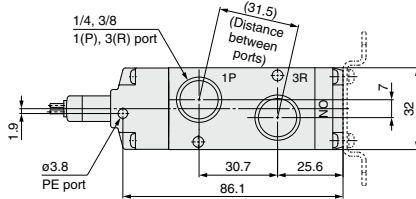
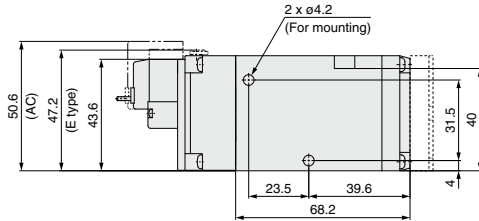
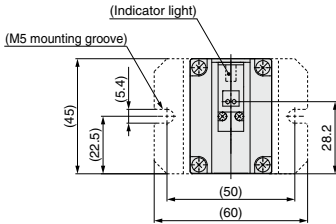
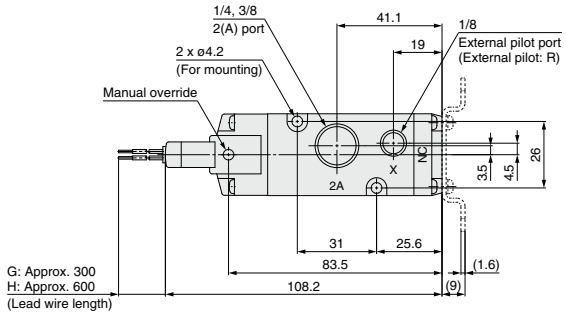

|           |
|-----------|
| SYJ       |
| VQZ       |
| <b>VP</b> |
| VG        |
| VP3       |

### L-type plug connector (L)

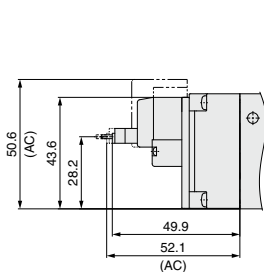

### M-type plug connector (M)

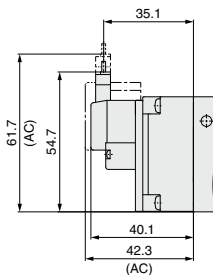

### DIN terminal (D,Y)

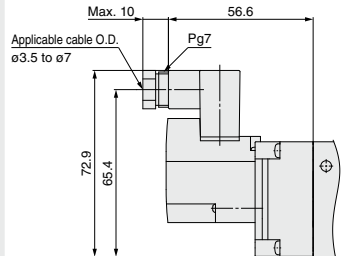

# Rubber Seal/3 Port/Pilot Poppet Type Manifold Common Exhaust **Type 41/** Individual Exhaust **Type 42** **VP300/500/700 Series**

## How to Order Manifold

### Type 41/Common exhaust

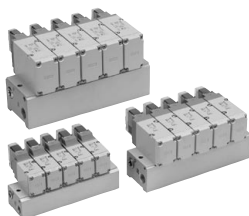

VV3P **3** - 41  - **04** 1 - **02**

#### Series

|   |       |
|---|-------|
| 3 | VP300 |
| 5 | VP500 |
| 7 | VP700 |

#### Pilot type

|     |                |
|-----|----------------|
| Nil | Internal pilot |
| R   | External pilot |

Note) When the external pilot type manifold is selected, external pilot type valves are mounted.

#### Thread type

|     |      |
|-----|------|
| Nil | Rc   |
| F   | G    |
| N   | NPT  |
| T   | NPTF |

#### Port size

| Symbol | Port size | Applicable series |
|--------|-----------|-------------------|
| 02     | 1/4       | VP300             |
| 03     | 3/8       | VP500             |
| 04     | 1/2       | VP700             |

#### Stations

|    |             |
|----|-------------|
| 02 | 2 stations  |
| :  | :           |
| 20 | 20 stations |

### Type 42/Individual exhaust



VV3P **3** - 42  - **04** 3 - **02**

#### Series

|   |       |
|---|-------|
| 3 | VP300 |
| 5 | VP500 |
| 7 | VP700 |

#### Pilot type

|     |                |
|-----|----------------|
| Nil | Internal pilot |
| R   | External pilot |

Note) When the external pilot type manifold is selected, external pilot type valves are mounted.

#### Thread type

|     |      |
|-----|------|
| Nil | Rc   |
| F   | G    |
| N   | NPT  |
| T   | NPTF |

#### Port size

| Symbol | Port size | Applicable series |
|--------|-----------|-------------------|
| 02     | 1/4       | VP300             |
| 03     | 3/8       | VP500             |
| 04     | 1/2       | VP700             |

#### Stations

|    |             |
|----|-------------|
| 02 | 2 stations  |
| :  | :           |
| 20 | 20 stations |

# Pilot Poppet Type Common Exhaust **Type 41** / Individual Exhaust **Type 42** **VP300/500/700 Series**



Note) Only DIN and conduit terminal types are available for AC mode. Refer to the electrical entry for details.

## How to Order Valve (With a gasket and two mounting bolts)

\* For low wattage specification, refer to "How to Order Valve" on page 1278.

**VP 3 4 4**     **- 5 G**    **1 - A -**

**Series**

|   |       |
|---|-------|
| 3 | VP300 |
| 5 | VP500 |
| 7 | VP700 |

**Pilot type**

|     |                |
|-----|----------------|
| Nil | Internal pilot |
| R   | External pilot |

**Pressure specification**

|     |                              |
|-----|------------------------------|
| Nil | Standard (0.7 MPa)           |
| K   | High-pressure type (1.0 MPa) |

**Coil specification**

|     |                                     |
|-----|-------------------------------------|
| Nil | Standard                            |
| T   | With power saving circuit (DC only) |

Note) Be sure to select the power saving circuit type when it is continuously energized for a long time. (Refer to page 1296 for details.)

\* T type is only available for DC mode. When T is selected, only Z type of light/surge voltage suppressor is available.

(Note that when the electrical entry of DIN terminal type without connector is selected, only DOS and YOS are available.)

**Rated voltage**

| DC            |                   |
|---------------|-------------------|
| 5             | 24 VDC            |
| 6             | 12 VDC            |
| AC (50/60 Hz) |                   |
| 1             | 100 VAC           |
| 2             | 200 VAC           |
| 3             | 110 VAC (115 VAC) |
| 4             | 220 VAC (230 VAC) |
| 7             | 240 VAC           |
| B             | 24 VAC            |

**Type of actuation**

|   |                        |
|---|------------------------|
| A | N.C. (Normally closed) |
| B | N.O. (Normally open)   |

**Manual override**

| Nil: Non-locking push type | D: Push-turn locking slotted type | E: Push-turn locking lever type |
|----------------------------|-----------------------------------|---------------------------------|
|                            |                                   |                                 |

**Light/surge voltage suppressor**

|     | DC  | AC                    |
|-----|---|-----------------------|
| Nil | Without light/surge voltage suppressor          | <input type="radio"/> |
| S   | With surge voltage suppressor                   | <input type="radio"/> |
| Z   | With light/surge voltage suppressor             | <input type="radio"/> |
| R   | With surge voltage suppressor (Non-polar)       | <input type="radio"/> |
| U   | With light/surge voltage suppressor (Non-polar) | <input type="radio"/> |

Note) There is no S option for AC mode, since a rectifier prevents surge voltage generation.

\* In the DIN terminal type, since a light is installed in the connector, DOZ, DOU, YOZ, YOU are not available.

**Caution**

When using the surge voltage suppressor type, residual voltage will remain. Refer to page 1300 for details.

**Made to Order**

|      |  |
|------|--|
| Nil  | —  |
| X500 | Pilot exhaust port with piping thread (M3) specification (Refer to page 1291). |
| X600 | Triac output specification (Refer to page 1291).                               |

**Electrical entry**

| Grommet  | L-type plug connector                                | M-type plug connector                             | DIN terminal                                      | DIN (EN175301-803) terminal                       | Conduit terminal                                  |
|--|--|---|---|---|---|
|  |  |   |   |   |   |
| G: Lead wire length 300 mm<br>H: Lead wire length 600 mm   | L: With lead wire (length 300 mm)                    | M: With lead wire (length 300 mm)                 | D: With connector                                 | Y: With connector                                 | T: Conduit terminal                               |
|  |  |   |   |   |   |
| G: Lead wire length 300 mm<br>H: Lead wire length 600 mm<br>DC<br>Without light/surge voltage suppressor | LN: Without lead wire                                | MN: Without lead wire                             | DO: Without connector                             | YO: Without connector                             |   |
| CE-compliant   | DC <input type="checkbox"/> <input type="checkbox"/> | <input type="checkbox"/> <input type="checkbox"/> | <input type="checkbox"/> <input type="checkbox"/> | <input type="checkbox"/> <input type="checkbox"/> | <input type="checkbox"/> <input type="checkbox"/> |

\* LN and MN types are with 2 sockets.

\* Refer to page 1294 when different length of lead wire for L/M-type plug connector is required.

\* Refer to page 1295 for details on the DIN (EN175301-803) terminal.

Note) With the same specifications as the DC type, all lead wire entries for the 24 VAC type are CE marking compliant.



SYJ

VQZ

VP

VG

VP3

# VP300/500/700 Series

Piping is concentrated on the base side.

All external pilots are gathered in the base.

Common external pilot port allows one piping.

2 types of exhaust ports

Common or individual exhaust type are available. For individual exhaust type, exhaust can be restricted.

Easy to change between N.C. and N.O.

Type of actuation can be easily changed from normally closed to normally open by changing the direction of a valve and end-plate only 180°.

- Refer to page 1300 for changing the type of actuation.



## Manifold Specifications

| Series | Base model | Piping specifications |                    |           | Applicable valve | Applicable stations <sup>(Note)</sup> | Manifold base Weight: W [g]<br>Stations: n |
|--------|------------|-----------------------|--------------------|-----------|------------------|---------------------------------------|--|
|        |            | 1P (SUP) port type    | 3R (EXH) port type | Port size |                  |                                       |  |
| VP300  | VV3P3-41   | Common                | Common             | 1/4       | VP344            | 2 to 20 stations                      | W = 110n + 90                              |
|        | Individual |                       |                    |           |                  |                                       |  |
| VP500  | VV3P5-41   |                       | Common             | 3/8       | VP544            | 2 to 20 stations                      | W = 190n + 150                             |
|        | VV3P5-42   |                       | Individual         |           |                  |                                       |  |
| VP700  | VV3P7-41   |                       | Common             | 1/2       | VP744            | 2 to 20 stations                      | W = 410n + 380                             |
|        | VV3P7-42   |                       | Individual         |           |                  |                                       |  |

Note) Supply pressure to 1(P) ports and exhaust pressure from 3(R) ports on both sides for 10 stations or more.

## Manifold Option

| Description   | Part no.    | Applicable manifold base model |
|---|-------------|--------------------------------|
| Blanking plate assembly<br>(With a gasket and two mounting bolts) | VP300-25-1A | VV3P3                          |
|   | VP500-25-1A | VV3P5                          |
|   | VP700-25-1A | VV3P7                          |

## How to Order Manifold Assembly (Example)

### Ordering example (VV3P3-41)

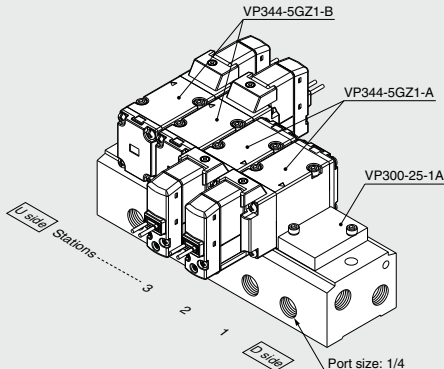

- VV3P3-41-051-02 ..... 1 set (Type 41, 5-station manifold base part no.)
- \* VP300-25-1A ..... 1 set (Blanking plate assembly part no.)
  - \* VP344-5GZ1-A ..... 2 sets (N.C. type part no.)
  - \* VP344-5GZ1-B ..... 2 sets (N.O. type part no.)

The asterisk denotes the symbol for assembly. Prefix it to the part nos. of the solenoid valve, etc.

\* Indicate the valves to be attached below the manifold part number, in order starting from station 1 as shown in the drawing.



**VP300 Series/Dimensions**

**Type 41/Common exhaust: VV3P3-41 □ - [Stations] 1-02**  
**Grommet (G)**

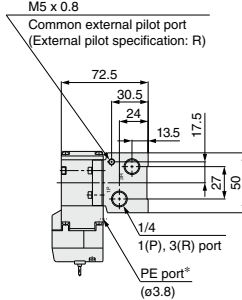
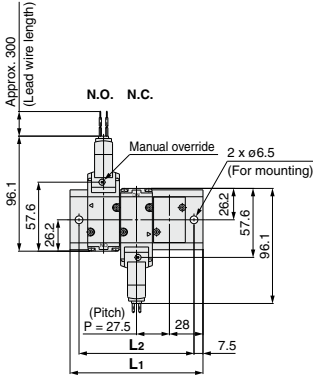

\* Refer to page 1291 separately when piping to PE port is required.

(Station n) ----- (Station 1)

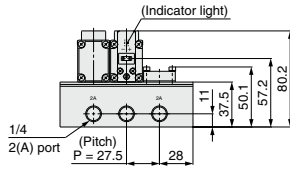

| Station n | 2 stations | 3   | 4     | 5   | 6     | 7   | 8     | 9   | 10    | 11  | 12    | 13  | 14    | 15  | 16    | 17  | 18    | 19  | 20 stations |
|-----------|------------|-----|-------|-----|-------|-----|-------|-----|-------|-----|-------|-----|-------|-----|-------|-----|-------|-----|-------------|
| L1        | 83.5       | 111 | 138.5 | 166 | 193.5 | 221 | 248.5 | 276 | 303.5 | 331 | 358.5 | 386 | 413.5 | 441 | 468.5 | 496 | 523.5 | 551 | 578.5       |
| L2        | 68.5       | 96  | 123.5 | 151 | 178.5 | 206 | 233.5 | 261 | 288.5 | 316 | 343.5 | 371 | 398.5 | 426 | 453.5 | 481 | 508.5 | 536 | 563.5       |

**Grommet (G)**  
**DC without light/surge voltage suppressor**

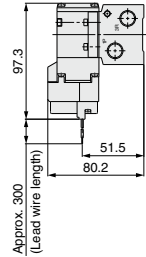

**L-type plug connector (L)**

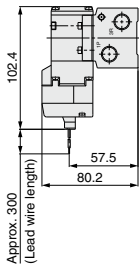

**M-type plug connector (M)**

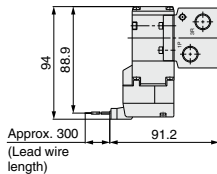

**DIN terminal (D, Y)**

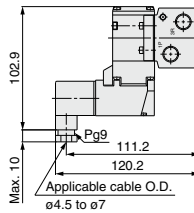

**Conduit terminal (T)**

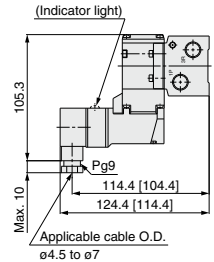

[ ]: Without indicator light

Unless otherwise indicated, dimensions are the same as Grommet (G).

# VP300/500/700 Series

## VP300 Series/Dimensions

Type 42/Individual exhaust: VV3P3-42□-□ Stations 3-02

### Grommet (G)

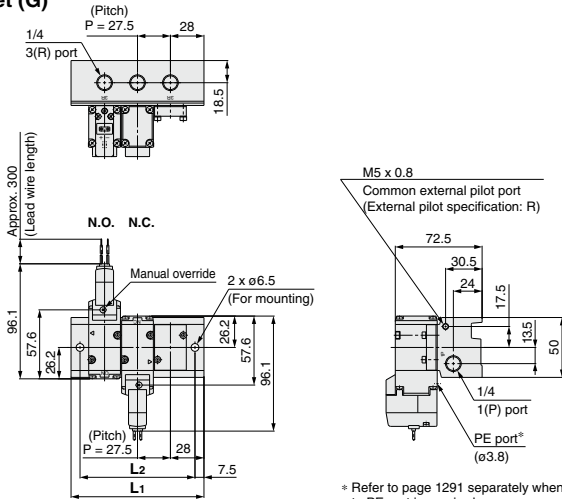

\* Refer to page 1291 separately when piping to PE port is required.

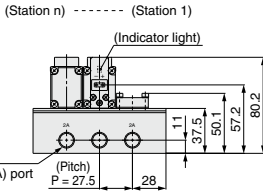

### Grommet (G) DC without light/surge voltage suppressor

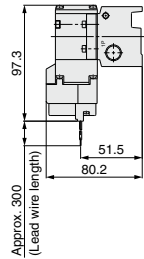

| Station n | 2 stations | 3   | 4     | 5   | 6     | 7   | 8     | 9   | 10    | 11  | 12    | 13  | 14    | 15  | 16    | 17  | 18    | 19  | 20 stations |
|-----------|------------|-----|-------|-----|-------|-----|-------|-----|-------|-----|-------|-----|-------|-----|-------|-----|-------|-----|-------------|
| L1        | 83.5       | 111 | 138.5 | 166 | 193.5 | 221 | 248.5 | 276 | 303.5 | 331 | 358.5 | 386 | 413.5 | 441 | 468.5 | 496 | 523.5 | 551 | 578.5       |
| L2        | 68.5       | 96  | 123.5 | 151 | 178.5 | 206 | 233.5 | 261 | 288.5 | 316 | 343.5 | 371 | 398.5 | 426 | 453.5 | 481 | 508.5 | 536 | 563.5       |

### L-type plug connector (L)

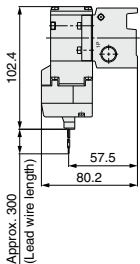

### M-type plug connector (M)

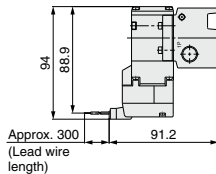

### DIN terminal (D, Y)

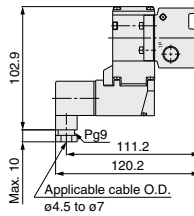

### Conduit terminal (T)

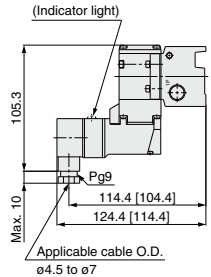

[ ]: Without indicator light

Unless otherwise indicated, dimensions are the same as Grommet (G).

**VP500 Series/Dimensions**

**Type 41/Common exhaust: VV3P5-41 □ -Stations 1-03**

**Grommet (G)**

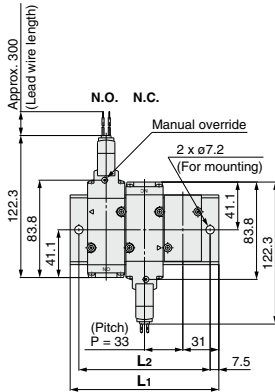

(Station n) ----- (Station 1)

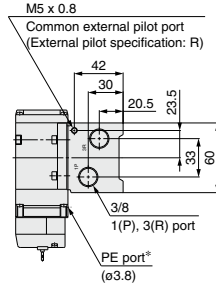
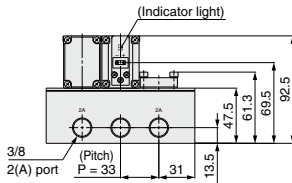

\* Refer to page 1291 separately when piping to PE port is required.

| Station n | 2 stations | 3   | 4   | 5   | 6   | 7   | 8   | 9   | 10  | 11  | 12  | 13  | 14  | 15  | 16  | 17  | 18  | 19  | 20 stations |
|-----------|------------|-----|-----|-----|-----|-----|-----|-----|-----|-----|-----|-----|-----|-----|-----|-----|-----|-----|-------------|
| L1        | 95         | 128 | 161 | 194 | 227 | 260 | 293 | 326 | 359 | 392 | 425 | 458 | 491 | 524 | 557 | 590 | 623 | 656 | 689         |
| L2        | 80         | 113 | 146 | 179 | 212 | 245 | 278 | 311 | 344 | 377 | 410 | 443 | 476 | 509 | 542 | 575 | 608 | 641 | 674         |

**Grommet (G)**  
DC without light/surge voltage suppressor

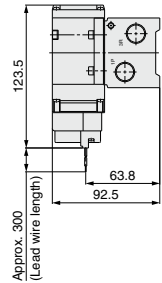

**L-type plug connector (L)**

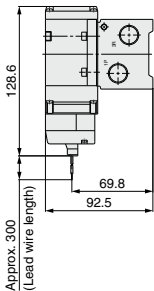

**M-type plug connector (M)**

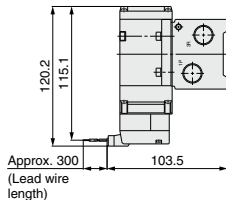

**DIN terminal (D, Y)**

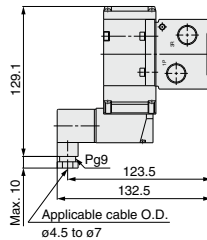

**Conduit terminal (T)**

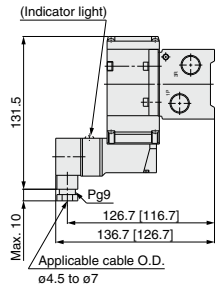

[ ]: Without indicator light

SYJ

VQZ

VP

VG

VP3

# VP300/500/700 Series

## VP500 Series/Dimensions

Type 42/Individual exhaust: VV3P5-42□- Stations 3-03

### Grommet (G)

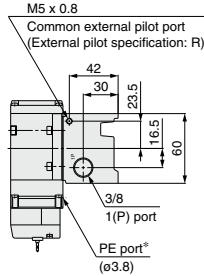
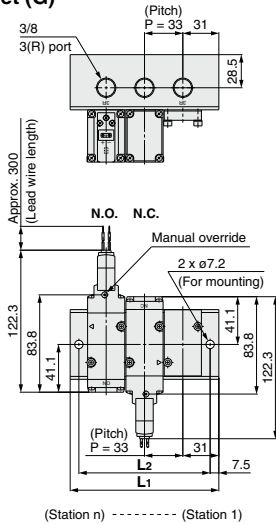

\* Refer to page 1291 separately when piping to PE port is required.

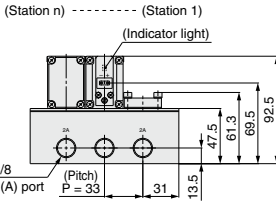

### Grommet (G) DC without light/surge voltage suppressor

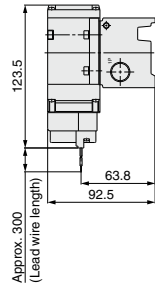

| Station n | 2 stations | 3   | 4   | 5   | 6   | 7   | 8   | 9   | 10  | 11  | 12  | 13  | 14  | 15  | 16  | 17  | 18  | 19  | 20 stations |
|-----------|------------|-----|-----|-----|-----|-----|-----|-----|-----|-----|-----|-----|-----|-----|-----|-----|-----|-----|-------------|
| L1        | 95         | 128 | 161 | 194 | 227 | 260 | 293 | 326 | 359 | 392 | 425 | 458 | 491 | 524 | 557 | 590 | 623 | 656 | 689         |
| L2        | 80         | 113 | 146 | 179 | 212 | 245 | 278 | 311 | 344 | 377 | 410 | 443 | 476 | 509 | 542 | 575 | 608 | 641 | 674         |

### L-type plug connector (L)

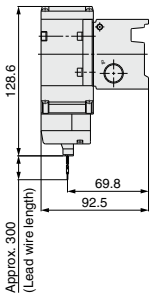

### M-type plug connector (M)

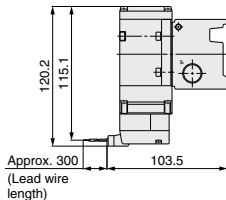

### DIN terminal (D, Y)

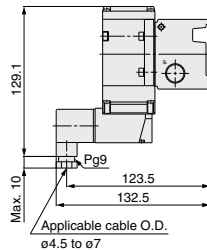

### Conduit terminal (T)

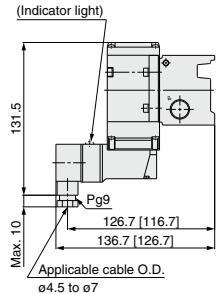

[ ]: Without indicator light

**VP700 Series/Dimensions**

Type 41/Common exhaust: **VV3P7-41** □ - Stations **1-04**

**Grommet (G)**

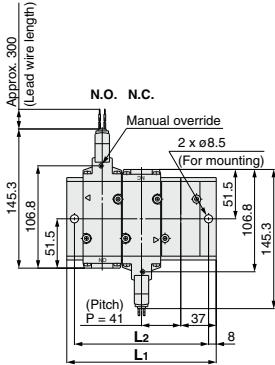

(Station n) ----- (Station 1)

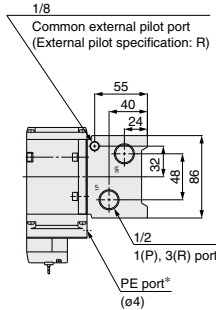

\* Refer to page 1291 separately when piping to PE port is required.

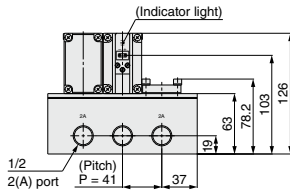

| Station n | 2 stations | 3   | 4   | 5   | 6   | 7   | 8   | 9   | 10  | 11  | 12  | 13  | 14  | 15  | 16  | 17  | 18  | 19  | 20 stations |
|-----------|------------|-----|-----|-----|-----|-----|-----|-----|-----|-----|-----|-----|-----|-----|-----|-----|-----|-----|-------------|
| L1        | 115        | 156 | 197 | 238 | 279 | 320 | 361 | 402 | 443 | 484 | 525 | 566 | 607 | 648 | 689 | 730 | 771 | 812 | 853         |
| L2        | 99         | 140 | 181 | 222 | 263 | 304 | 345 | 386 | 427 | 468 | 509 | 550 | 591 | 632 | 673 | 714 | 755 | 796 | 837         |

**Grommet (G)**

**DC without light/surge voltage suppressor**

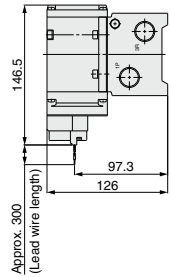

**L-type plug connector (L)**

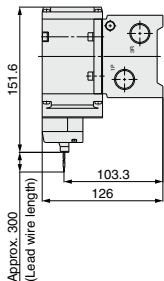

**M-type plug connector (M)**

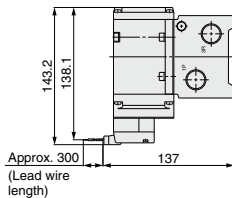

**DIN terminal (D, Y)**

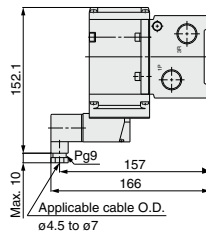

**Conduit terminal (T)**

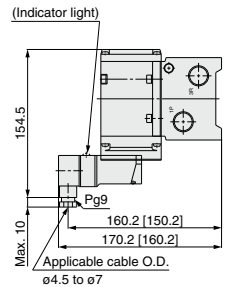

[ ]: Without indicator light

Unless otherwise indicated, dimensions are the same as Grommet (G).

# VP300/500/700 Series

## VP700 Series/Dimensions

Type 42/Individual exhaust: VV3P7-42□ - Stations 3-04

### Grommet (G)

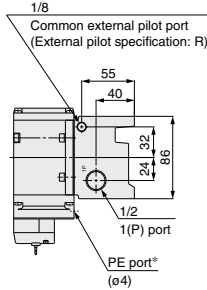
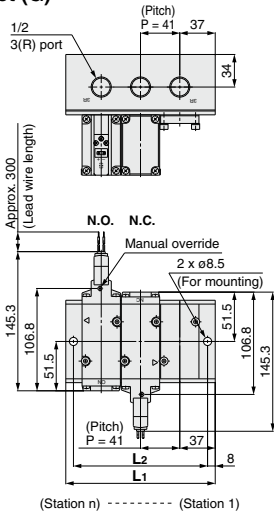

\* Refer to page 1291 separately when piping to PE port is required.

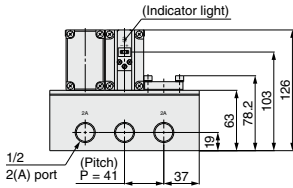

### Grommet (G) DC without light/surge voltage suppressor

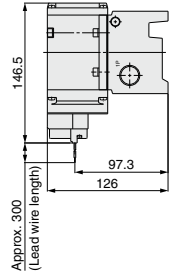

| Station n | 2 stations | 3   | 4   | 5   | 6   | 7   | 8   | 9   | 10  | 11  | 12  | 13  | 14  | 15  | 16  | 17  | 18  | 19  | 20 stations |
|-----------|------------|-----|-----|-----|-----|-----|-----|-----|-----|-----|-----|-----|-----|-----|-----|-----|-----|-----|-------------|
| L1        | 115        | 156 | 197 | 238 | 279 | 320 | 361 | 402 | 443 | 484 | 525 | 566 | 607 | 648 | 689 | 730 | 771 | 812 | 853         |
| L2        | 99         | 140 | 181 | 222 | 263 | 304 | 345 | 386 | 427 | 468 | 509 | 550 | 591 | 632 | 673 | 714 | 755 | 796 | 837         |

### L-type plug connector (L)

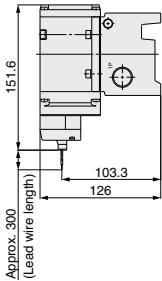

### M-type plug connector (M)

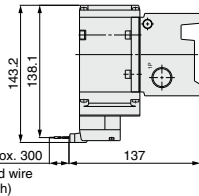

### DIN terminal (D, Y)

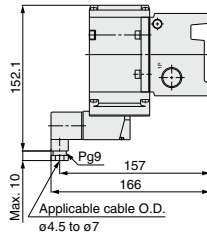

### Conduit terminal (T)

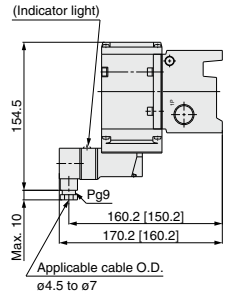

[ ]: Without indicator light

Unless otherwise indicated, dimensions are the same as Grommet (G).



## 1 Pilot Exhaust Port with Piping Thread (M3) Specification

In this specification, piping to the pilot exhaust port (PE port) is available when the valve is used in an environment where the exhaust from the pilot valve is not allowable, or intrusion of ambient dust should be prevented.

### How to Order Valve

VP $\frac{3}{5}$  $\frac{4}{4}$  □□□ - □□□□□ 1 - □□□□ - X500

- Entry is the same as standard products. The specifications, performance and external dimensions are the same as those of standard models.

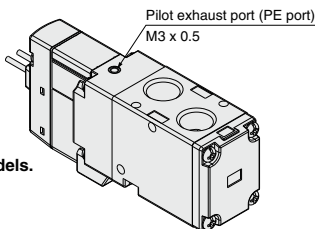

## 2 Body Ported Interchangeable Specification with the Previous Valve Mounting Hole Pitch Type

The mounting hole has been changed to the long type in order to provide interchangeability with the previous VP300/500 series.

### How to Order Valve

VP $\frac{3}{5}$ 42 □□□ - □□□□□ 1 - □□□□ - X505

- Entry is the same as standard products. The specifications, performance and external dimensions are the same as those of standard models.

Note) VP742 is not available because the mounting hole pitch is the same as the previous type.

VP342

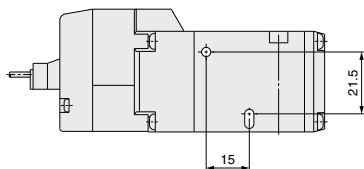

VP542

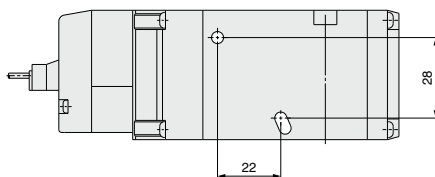

SYJ

VQZ

VP

VG

VP3

## 3 TRIAC Output Specification

For AC type valve, use this specification when the pilot valve is not recovered even though valve power supply is turned OFF at the equipment using output unit with large leakage voltage over 8% of the rated voltage (TRIAC output such as PLC or SSR, etc.). Combination with low wattage specification is not possible.

### How to Order Valve

VP $\frac{3}{5}$  $\frac{4}{7}$  □□□ - □□□□□ 1 - □□□□ - □ - □ - X600

- Entry is the same as standard products.

Note) Rated voltage: AC type only

# Rubber Seal 3 Port/Pilot Poppet Type VP300/500/700 Series



## How to Order

**30-VP 3 4 4 - 1 D B - 01 A - F - Q**

**Conforming to CSA standard**

**VP series solenoid valve**

**Body size**

|   |              |
|---|--------------|
| 3 | 1/4 standard |
| 5 | 3/8 standard |
| 7 | 1/2 standard |

**Type of actuation**

|   |  |
|---|--|
| 4 | In common between N.C. and N.O. (Pilot type) |
|---|--|

**Body type**

|   |              |
|---|--------------|
| 2 | Body ported  |
| 4 | Base mounted |

**Valve option**

|     |                           |
|-----|---------------------------|
| Nil | Standard (Internal pilot) |
| R*  | External pilot            |

\* Semi-standard

**Rated voltage**

|    |                          |
|----|--------------------------|
| 1  | 100 VAC, 50/60 Hz        |
| 2  | 200 VAC, 50/60 Hz        |
| 3* | 110 to 120 VAC, 50/60 Hz |
| 4* | 220 VAC, 50/60 Hz        |
| 5  | 24 VDC                   |
| 6* | 12 VDC                   |
| 7* | 240 VAC, 50/60 Hz        |

\* Semi-standard

**Electrical entry**

|    |                                  |
|----|----------------------------------|
| D  | DIN terminal (With connector)    |
| DO | DIN terminal (Without connector) |

**CE-compliant**

|     |              |
|-----|--------------|
| Nil | —            |
| Q   | CE-compliant |

**Option**

|     |                 |
|-----|-----------------|
| Nil | Without bracket |
| F   | With bracket    |

\* 30-VP342, 542, and 742 only

**Passage symbol**

|   |                 |
|---|-----------------|
| A | Normally closed |
| B | Normally open   |

**Thread type**

|     |      |
|-----|------|
| Nil | Rc   |
| F   | G    |
| N   | NPT  |
| T   | NPTF |

**Port size**

| Symbol | Port size         | 30-VP342 | 30-VP542 | 30-VP742 |
|--------|-------------------|----------|----------|----------|
| Nil*   | Without sub-plate | ●        | ●        | ●        |
| 01     | 1/8               | ●        |          |          |
| 02     | 1/4               | ●        | ●        |          |
| 03     | 3/8               |          | ●        | ●        |
| 04     | 1/2               |          |          | ●        |

\* 30-VP344, VP544, and VP744 only

**Manual override**

|     |                      |
|-----|----------------------|
| Nil | Push type            |
| B*  | Locking slotted type |
| C*  | Locking lever type   |

\* Semi-standard

**Light/Surge voltage suppressor**

|     |                                     |
|-----|-------------------------------------|
| Nil | None                                |
| Z*  | With light/surge voltage suppressor |

\* Semi-standard

### Caution

For safety instructions, specific product precautions, product specifications, dimensions, and model selection, refer to the individual product catalog (discontinued products). However, note that the DIN connector differs from the standard product.





# VP Series

## Specific Product Precautions 1

Be sure to read this before handling the products.

Refer to back page 50 for Safety Instructions and pages 3 to 9 for 3/4/5 Port Solenoid Valve Precautions.

### Manual Override

#### ⚠ Warning

Without an electric signal for the solenoid valve the manual override is used for switching the main valve. Connected actuator is started by manual operation. Use the manual override after confirming that there is no danger.

##### ■ Non-locking push type

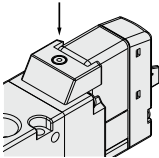

Push down on the manual override button with a small screwdriver until it stops. Release the screwdriver and the manual override will return.

##### ■ Push-turn locking slotted type

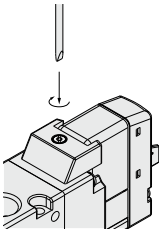

Locked condition

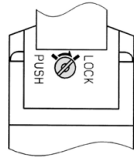

Push the manual override button with a small flat head screwdriver until it stops. Turn it in the clockwise direction at 90° to lock the manual. Turn it counterclockwise to release it.

##### ■ Push-turn locking lever type

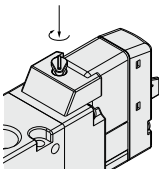

Locked condition

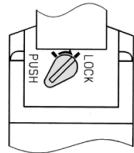

After pushing down, turn in the direction of the arrow. If it is not turned, it can be operated the same way as the non-locking type.

#### ⚠ Caution

When locking the manual override with the push-turn locking type (D or E type), be sure to push it down before turning. Turning without first pushing it down can cause damage to the manual override and other trouble such as air leakage, etc. Do not apply excessive torque when turning the locking type manual override. (0.1 N·m)

### How to Use L/M-Type Plug Connector

#### ⚠ Caution

##### 1. Attaching and detaching connectors

- To attach a connector, hold the lever and connector unit between your fingers and insert straight onto the pins of the solenoid valve so that the lever's pawl is pushed into the groove and locks.
- To detach a connector, remove the pawl from the groove by pushing the lever downward with your thumb, and pull the connector straight out.

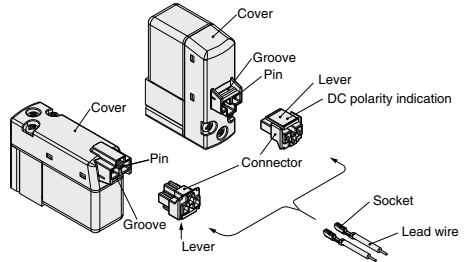

##### 2. Crimping lead wires and sockets

Not necessary if ordering the lead wire pre-connected model. Strip 3.2 to 3.7 mm at the end of the lead wires, insert the ends of the core wires evenly into the sockets, and then crimp with a crimping tool. When this is done, take care that the coverings of the lead wires do not enter the core wire crimping area. (Please contact SMC for details on the crimping tool.)

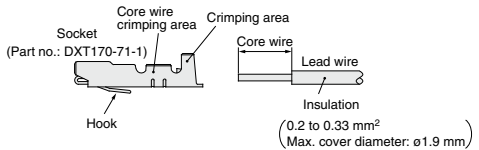

##### 3. Attaching and detaching sockets with lead wire

###### • Attaching

Insert the sockets into the square holes of the connector (⊕, ⊖ indication), and continue to push the sockets all the way in until they lock by hooking into the seats in the connector. (When they are pushed in, their hooks open and they are locked automatically.) Then, confirm that they are locked by pulling lightly on the lead wires.

###### • Detaching

To detach a socket from a connector, pull out the lead wire while pressing the socket's hook with a stick having a thin tip (approx. 1 mm). If the socket will be used again, first spread the hook outward.

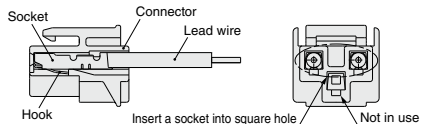

SYJ

VQZ

VP

VG

VP3



# VP Series

## Specific Product Precautions 2

Be sure to read this before handling the products.

Refer to back page 50 for Safety Instructions and pages 3 to 9 for 3/4/5 Port Solenoid Valve Precautions.

### Plug Connector Lead Wire Length

#### ⚠ Caution

Plug connector lead wires have a standard length of 300 mm, however, the following lengths are also available.

#### How to Order Connector Assembly

|                    |               |  |
|--------------------|---------------|--|
| DC                 | : V200-30-4A- |  |
| 100 VAC            | : V200-30-1A- |  |
| 200 VAC            | : V200-30-2A- |  |
| AC other voltages: | V200-30-3A-   |  |

Without lead wire : V200-30-A  
(With connector and 2 pcs. of socket)

#### ● Lead wire length

|     |         |
|-----|---------|
| Nil | 300 mm  |
| 6   | 600 mm  |
| 10  | 1000 mm |
| 15  | 1500 mm |
| 20  | 2000 mm |
| 25  | 2500 mm |
| 30  | 3000 mm |
| 50  | 5000 mm |

#### How to Order

Include the connector assembly part number together with the part number for the plug connector's solenoid valve without connector.

(Example) 2000 mm lead wire length

|                |                |
|----------------|----------------|
| <b>DC</b>      | <b>AC</b>      |
| VP342-5L01-01A | VP342-1L01-01A |
| V200-30-4A-20  | V200-30-1A-20  |

### How to Use DIN Terminal

The DIN terminal type with an IP65 enclosure is protected against dust and water, however, it must not be used in water.

#### ⚠ Caution

##### Connection

- Loosen the set screw and pull the connector out of the solenoid valve terminal block.
- After removing the set screw, insert a flat head screwdriver, etc. into the notch on the bottom of the terminal block and pry it open, separating the terminal block and the housing.
- Loosen the terminal screws on the terminal block, insert the core of the lead wire into the terminal, and attach securely with the terminal screws.  
In addition, when using the DC mode type with a surge voltage suppressor (polar: S and Z types), connect wires corresponding to the polarity (+ or -) that is printed on the terminal block.
- Tighten the ground nut to secure the wire.  
In the case of connecting wires, select cable cords carefully because if those out of the specified range ( $\phi 4.5$  to  $\phi 7$ ) are used, it will not be able to satisfy IP65 (enclosure). Tighten the ground nut and set screw within the specified range of torque.

##### Changing the entry direction

After separating terminal block and housing, the cord entry direction can be changed by attaching the housing in the opposite direction.

\* Make sure not to damage elements, etc., with the lead wires of the cord.

##### Precautions

Plug in and pull out the connector vertically without tilting to one side.

##### Applicable cable

Cable O.D.:  $\phi 4.5$  to  $\phi 7$

(Reference)  $0.5 \text{ mm}^2$  to  $1.5 \text{ mm}^2$ , 2-core or 3-core, equivalent to JIS C 3306

##### Applicable crimped terminal

O terminal: R1.25-4M that is specified in JIS C 2805

Y terminal: 1.25-3L, which is released by JST Mfg. Co., Ltd.

Stick terminal: Size 1.5 or shorter

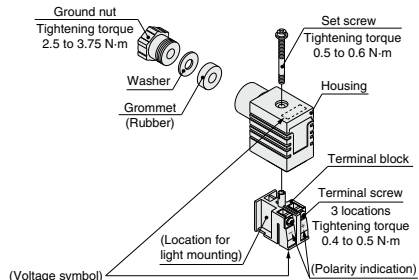



# VP Series

## Specific Product Precautions 3

Be sure to read this before handling the products.

Refer to back page 50 for Safety Instructions and pages 3 to 9 for 3/4/5 Port Solenoid Valve Precautions.

### DIN (EN175301-803) Terminal

Y type DIN terminal corresponds to the DIN connector with terminal pitch 10 mm, which complies with EN175301-803B. Since the terminal pitch is different from the D type DIN connector, these two types are not interchangeable.

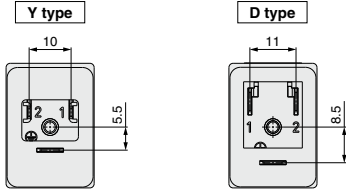

### How to Order DIN Connector

#### Caution

● Without indicator light

DC, AC, Other voltages: V200-□-1

● With indicator light

DC  
Polar type (□Z) : V200-□-3-□

Non-polar type (□U) : V200-□-5-□

● Rated voltage

|    |        |
|----|--------|
| 05 | 24 VDC |
| 06 | 12 VDC |

AC (□Z) : V200-□-7-□

Connector specification ●

|    |        |
|----|--------|
| 61 | D type |
| 63 | Y type |

● Rated voltage

|    |                       |
|----|-----------------------|
| 01 | 100/110 VAC [115 VAC] |
| 02 | 200/220 VAC [230 VAC] |
| 07 | 240 VAC               |

(Note) Order no. for 24 VAC specification is V200-61-5-B.

### Circuit with indicator light (Built-in connector)

#### DC (□U) circuit

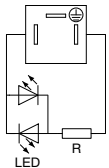

LED: Light emitting diode, R: Resistor

#### AC (□Z) circuit

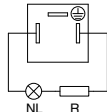

NL: Neon bulb R: Resistor

#### DC (□Z) circuit

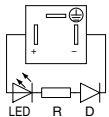

LED: Light emitting diode  
D: Protective diode  
R: Resistor

(Note) The 24 VAC specifications are the same as those in the DC (□U) circuit diagram.

### How to Use Conduit Terminal

#### Caution

##### Connection

- Loosen the set screw and remove the terminal block cover from the terminal block.
- Loosen the terminal screws on the terminal block, insert the core of the lead wire or crimped terminal into the terminal, and attach securely with the terminal screws.  
In addition, when using the DC mode type with a surge voltage suppressor (polar: S and Z types), connect wires to terminal 1 and 2 corresponding to the polarity (+ or -) as shown on the right figure.
- Secure the cord by fastening the ground nut.



In the case of connecting wires, select cable cords carefully because if those out of the specified range ( $\phi 4.5$  to  $\phi 7$ ) are used, it will not be able to satisfy IP65 (enclosure). Tighten the ground nut and set screw within the specified range of torque.

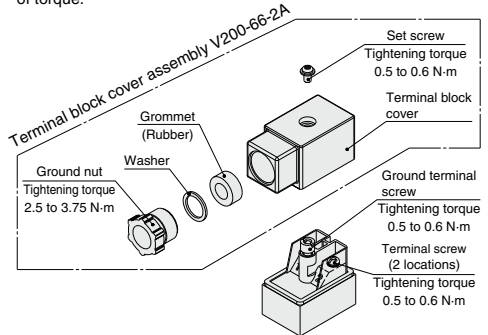

#### Applicable cable

Cable O.D.:  $\phi 4.5$  to  $\phi 7$   
(Reference)  $0.5 \text{ mm}^2$  to  $1.5 \text{ mm}^2$ , 2-core or 3-core, equivalent to JIS C 3306

#### Applicable crimped terminal

O terminal: Equivalent to R1.25-3 that is specified in JIS C 2805  
Y terminal: Equivalent to 1.25-3, which is released by JST Mfg. Co., Ltd.

\* Use O terminal when a ground terminal is used.

SYJ

VQZ

VP

VG

VP3



# VP Series

## Specific Product Precautions 4

Be sure to read this before handling the products.

Refer to back page 50 for Safety Instructions and pages 3 to 9 for 3/4/5 Port Solenoid Valve Precautions.

### Light/Surge Voltage Suppressor

#### ⚠ Caution

<DC>

##### ■ Polar type

With surge voltage suppressor (□S) Polarity protection diode

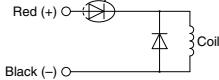

##### ● Grommet or L/M-type plug connector

With light/surge voltage suppressor (□Z) Polarity protection diode

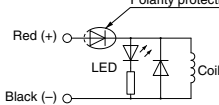

##### ● DIN or Conduit terminal

With light/surge voltage suppressor (□Z) Polarity protection diode

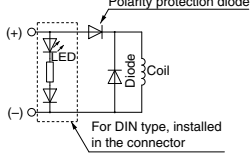

##### ■ Non-polar type

With surge voltage suppressor (□R)

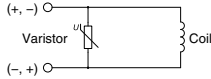

##### ● Grommet or L/M-type plug connector

With light/surge voltage suppressor (□U)

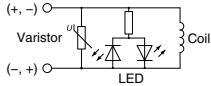

##### ● DIN or Conduit terminal

With light/surge voltage suppressor (□U) Varistor

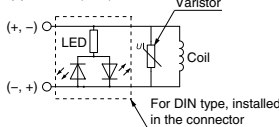

- Please connect correctly the lead wires to + (positive) and - (negative) indications on the connector. (For non-polar type, the lead wires can be connected to either one.)
- When the valve with polarity protection diode is used, the voltage will drop by approx. 1 V. Therefore, pay attention to the allowable voltage fluctuation (For details, refer to the solenoid specification of each type of valve).
- Solenoids, whose lead wires have been pre-wired: + (positive) side red and - (negative) side black.

##### ■ With power saving circuit

Power consumption is decreased by approx. 1/3 by reducing the wattage required to hold the valve in an energized state. (Effective energizing time is over 40 ms at 24 VDC.)

Refer to the electrical power waveform as shown below.

#### <Electrical power waveform of energy saving type>

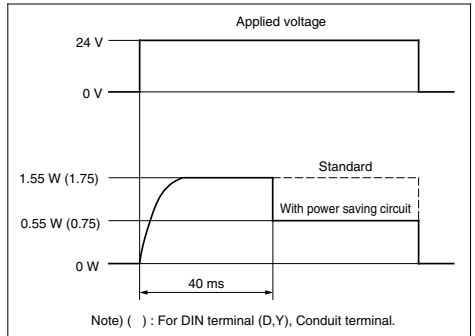

- Since the voltage will drop by approx. 0.5 V due to the transistor, pay attention to the allowable voltage fluctuation. (For details, refer to the solenoid specifications of each type of valve.)

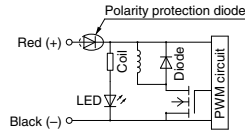

<AC>

There is no S option, since a rectifier prevents surge voltage generation.

##### ● Grommet or L/M-type plug connector

With light/surge voltage suppressor (□Z)

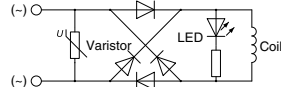

##### ● DIN or Conduit terminal

With light/surge voltage suppressor (□Z)

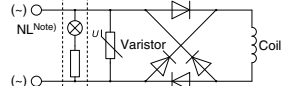

Note) NL: Neon bulb  
Note) LED for 24 VAC.



# Low Wattage Specification (VP300/500) Specific Product Precautions 5

Be sure to read this before handling the products.

Refer to back page 50 for Safety Instructions and pages 3 to 9 for 3/4/5 Port Solenoid Valve Precautions.

## Manual Override

### ⚠ Warning

#### 1. Non-locking push type [Standard]

Press in the direction of the arrow.

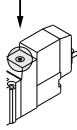

#### 2. Push-turn locking slotted type [D type]

After pushing down, turn in the direction of the arrow. If it is not turned, it can be operated the same way as the non-locking push type.

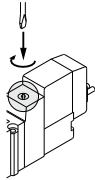

Locked position



### ⚠ Caution

When operating the D type, use a watchmakers' screwdriver and turn lightly.

[Torque: Less than 0.1 N·m]

#### 3. Push-turn locking lever type [E type]

After pushing down, turn in the direction of the arrow. If it is not turned, it can be operated the same way as the non-locking push type.

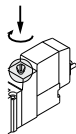

Locked position



### ⚠ Caution

When locking the manual override with the push-turn locking type (D or E type), be sure to push it down before turning. Turning without first pushing it down can cause damage to the manual override and other trouble such as air leakage, etc.

## Solenoid Valve for 200/220 VAC Specification

### ⚠ Warning

AC specification solenoid valves with grommet or L/M-type plug connector have a built-in rectifier circuit in the pilot section to operate the DC coil. With 200/220 VAC specification pilot valves, this built-in rectifier generates heat when energized. The surface may become hot depending on the energized condition; therefore, do not touch the solenoid valves.

## How to Use L/M-Type Plug Connector

### ⚠ Caution

#### 1. Connector attachment/detachment

- To attach a connector, hold the lever and connector unit between your fingers and insert straight onto the pins of the solenoid valve so that the lever's pawl is pushed into the groove and locks.
- To detach a connector, remove the pawl from the groove by pushing the lever downward with your thumb, and pull the connector straight out.

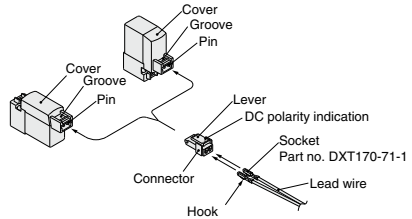

#### 2. Crimping lead wire and socket connection

Strip 3.2 to 3.7 mm at the end of the lead wires, insert the ends of the core wires evenly into the sockets, and then crimp with a crimping tool. When this is done, take care that the coverings of the lead wires do not enter the core wire crimping area. (Please contact SMC for the dedicated crimping tools.)

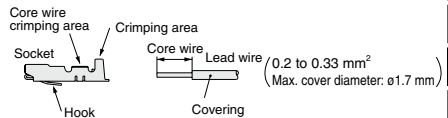

#### 3. Socket with lead wire attachment/detachment

##### ● Attachment

Insert the sockets into the square holes of the connector (with ⊕, ⊖ indication), and continue to push the sockets all the way in until they lock by hooking into the seats in the connector. (When they are pushed in, their hooks open and they are locked automatically.) Then, confirm that they are locked by pulling lightly on the lead wires.

##### ● Detachment

To detach a socket from a connector, pull out the lead wire while pressing the socket's hook with a stick having a thin tip (approx. 1 mm). If the socket will be used again, first spread the hook outward.

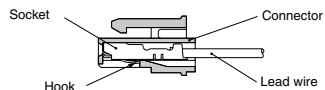

SYJ

VQZ

VP

VG

VP3



# Low Wattage Specification (VP300/500) Specific Product Precautions 6

Be sure to read this before handling the products.

Refer to back page 50 for Safety Instructions and pages 3 to 9 for 3/4/5 Port Solenoid Valve Precautions.

## Plug Connector Lead Wire Length

### ⚠ Caution

Plug connector lead wires have a standard length of 300 mm, however, the following lengths are also available.

### How to Order Connector Assembly

DC: **SY100-30-4A** - [ ]

100 VAC: **SY100-30-1A** - [ ]

200 VAC: **SY100-30-2A** - [ ]

Other AC voltages: **SY100-30-3A** - [ ]

Without lead wire: **SY100-30-A**

(With a connector and 2 sockets)

### How to Order

Specify the connector assembly part number together with the part number for the plug connector type solenoid valve without connector.

(Example) Lead wire length: 2000 mm

|                       |                       |
|-----------------------|-----------------------|
| <b>DC</b>             | <b>AC</b>             |
| <b>VP342Y-5LO1-01</b> | <b>VP342Y-1LO1-01</b> |
| <b>SY100-30-4A-20</b> | <b>SY100-30-1A-20</b> |

### ● Lead wire length

|     |         |
|-----|---------|
| Nil | 300 mm  |
| 6   | 600 mm  |
| 10  | 1000 mm |
| 15  | 1500 mm |
| 20  | 2000 mm |
| 25  | 2500 mm |
| 30  | 3000 mm |
| 50  | 5000 mm |

## Light/Surge Voltage Suppressor

### ⚠ Caution

<DC>

#### ● Grommet or L/M-type plug connector

##### ■ Polar type

With surge voltage suppressor (□S)

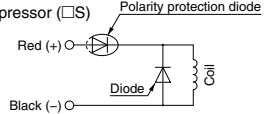

With light/surge voltage suppressor (□Z)

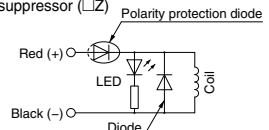

##### ■ Non-polar type

With surge voltage suppressor (□R)

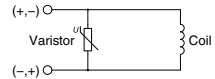

With light/surge voltage suppressor (□U)

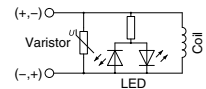

#### ● DIN terminal

##### ■ Non-polar type

With surge voltage suppressor (□S)

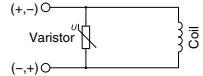

With light/surge voltage suppressor (□Z)

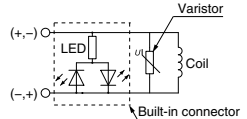



# Low Wattage Specification (VP300/500) Specific Product Precautions 6-1

Be sure to read this before handling the products.

Refer to back page 50 for Safety Instructions and pages 3 to 9 for 3/4/5 Port Solenoid Valve Precautions.

## Light/Surge Voltage Suppressor

### ⚠ Caution

<AC>

**S type is not available, since a rectifier prevents surge voltage generation.**

#### ●Grommet or L/M-type plug connector

With light/surge voltage suppressor (□Z)

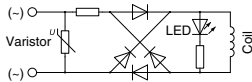

#### ●DIN terminal

With light/surge voltage suppressor (□Z)

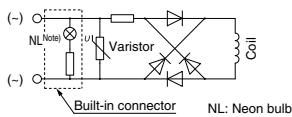

Note) LED for 24 VAC.

### Residual voltage of the surge voltage suppressor

Note) If a varistor or diode surge voltage suppressor is used, there is some residual voltage to the protection element and rated voltage. Therefore, refer to the table below and pay attention to the surge voltage protection on the controller side. Also, since the response time does change, refer to the specifications on pages 1265 and 1272.

#### Residual Voltage

| Surge voltage suppressor | DC           |              | AC          |
|--------------------------|--------------|--------------|-------------|
|                          | 24           | 12           |             |
| Diode                    | Approx. 1 V  |              | Approx. 1 V |
| Varistor                 | Approx. 47 V | Approx. 32 V | —           |

SYJ

VQZ

VP

VG

VP3



# Low Wattage Specification (VP300/500) Specific Product Precautions 7

Be sure to read this before handling the products.

Refer to back page 50 for Safety Instructions and pages 3 to 9 for 3/4/5 Port Solenoid Valve Precautions.

## How to Use DIN Connector

### 1. ISO#: Conforming to EN-175301-803C (former DIN 43650C) (Distance between pins: 8 mm)

The DIN terminal type with an IP65 (enclosure) is protected against dust and water, however, it must not be used in water.

### 2. Connection

- 1) Loosen the set screw and pull the connector out of the solenoid valve terminal block.
- 2) After removing the set screw, insert a flat head screwdriver, etc. into the notch on the bottom of the terminal block and pry it open, separating the terminal block and the housing.
- 3) Loosen the terminal screws (slotted head screw) on the terminal block, insert the core of the lead wire into the terminal according to wiring connection, and attach securely with the terminal screws.
- 4) Tighten the ground nut to secure the wire.

### 3. Changing the entry direction

After separating the terminal block and housing, the cord entry direction can be changed by attaching the housing in a different direction (four directions at 90° intervals).

\* Make sure not to damage a light, etc., with the lead wires of the cord.

### 4. Precautions

Plug in and pull out the connector vertically without tilting to one side.

### 5. Applicable cable

Cable O.D:  $\phi 3.5$  to  $\phi 7$

(Reference) 0.5 mm<sup>2</sup>, 2-core or 3-core, equivalent to JIS C 3306

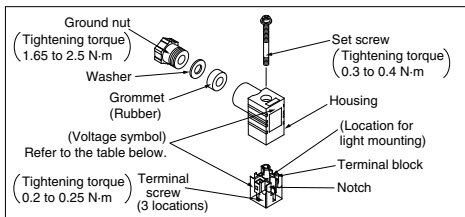

## DIN Connector Part No.

### ⚠ Caution

#### DIN terminal (D)

|                         |            |
|-------------------------|------------|
| Without indicator light | SY100-61-1 |
|-------------------------|------------|

#### With indicator light

| Rated voltage | Voltage symbol | Part no.      |
|---------------|----------------|---------------|
| 24 VDC        | 24 V           | SY100-61-3-05 |
| 12 VDC        | 12 V           | SY100-61-3-06 |
| 100 VAC       | 100 V          | SY100-61-2-01 |
| 200 VAC       | 200 V          | SY100-61-2-02 |
| 110 VAC       | 110 V          | SY100-61-2-03 |
| 220 VAC       | 220 V          | SY100-61-2-04 |

#### DIN terminal (Y)

##### Without indicator light

| Rated voltage          | Voltage symbol | Part no.   |
|------------------------|----------------|------------|
| Common to all voltages | None           | SY100-82-1 |

##### With indicator light

| Rated voltage     | Voltage symbol | Part no.      |
|-------------------|----------------|---------------|
| 24 VDC            | 24 V           | SY100-82-3-05 |
| 12 VDC            | 12 V           | SY100-82-3-06 |
| 100 VAC           | 100 V          | SY100-82-2-01 |
| 200 VAC           | 200 V          | SY100-82-2-02 |
| 110 VAC (115 VAC) | 110 V          | SY100-82-2-03 |
| 220 VAC (230 VAC) | 220 V          | SY100-82-2-04 |

### Circuit diagram with light

#### AC circuit diagram

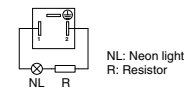

#### DC circuit diagram

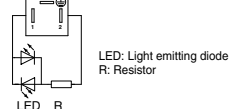

## Pilot Valve

The mounting of the low wattage type pilot valve is not interchangeable with that of the standard type. Additionally, be aware that the pilot valve cannot be replaced.

SYJ

VQZ

VP

VG

VP3





# Body Ported/Base Mounted Specification Specific Product Precautions 8

Be sure to read this before handling the products.

Refer to back page 50 for Safety Instructions and pages 3 to 9 for 3/4/5 Port Solenoid Valve Precautions.

## Light/Surge Voltage Suppressor

### ⚠ Caution

#### Residual voltage of the surge voltage suppressor

Note) If a varistor or diode surge voltage suppressor is used, there is some residual voltage to the protection element and rated voltage. Therefore, refer to the table below and pay attention to the surge voltage protection on the controller side. Also, since the response time does change, refer to the specifications on pages 1265 and 1272.

#### Residual Voltage

| Surge voltage suppressor | DC           |              | AC          |
|--------------------------|--------------|--------------|-------------|
|                          | 24           | 12           |             |
| S, Z                     | Approx. 1 V  |              | Approx. 1 V |
| R, U                     | Approx. 47 V | Approx. 32 V | —           |

## Type of Actuation Changing

### ⚠ Warning

When changing the actuation or restarting the valve after the change, make sure that safety is fully assured and pay great attention.

Example: Changing from N.C. to N.O.

#### 1) Base mounted

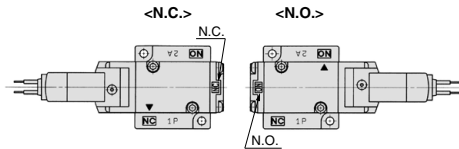

1. Remove the body from the sub-plate and reset the "▼" mark on the body corresponding to the "N.O." mark on the sub-plate as shown in the figure above.
2. Remove the end plate from the body and rotate the end plate by 180° so that the "N.O." mark on the end plate is at the top of the valve.

\* It is not necessary to change the piping when this is done.

#### 2) Body ported

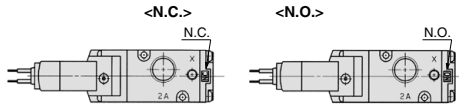

- Remove the end plate from the body and rotate the end plate by 180° to correspond the "N.O." mark on the end plate to the top of the valve.

\* Piping should be arranged as follows.

| Type of actuation \ Port | 1P           | 2A          | 3R           |
|--------------------------|--------------|-------------|--------------|
| N.C.                     | Inlet side   | Outlet side | Exhaust side |
| N.O.                     | Exhaust side | Outlet side | Inlet side   |

## Precautions when replacing the old VP series with new VP series

### ⚠ Caution

When replacing the built-in valve with the new VP series if the old VP series uses the external pilot manifold, be aware that the valve selection becomes different.

| Manifold model no.  | Mounting valve        |                |
|---|-----------------------|----------------|
|   | New VP                | Old VP         |
| VV3P□ <sup>41</sup> / <sub>42</sub> □□-□□<br>(Internal pilot) | Internal pilot        | Internal pilot |
| VV3P□ <sup>43</sup> R□□-□□<br>(External pilot)                | <b>External pilot</b> | Internal pilot |

#### <How to distinguish the external pilot manifold>

When the piping is connected to the external pilot port, this manifold is the external pilot manifold.

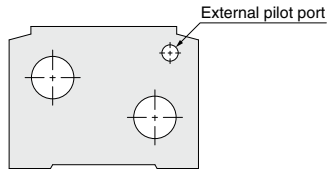

## One-touch Fittings

### ⚠ Caution

When fittings are used, they may interfere with one another depending on their types and sizes. Therefore, the dimensions of the fittings to be used should first be confirmed in their respective catalogs.

Fittings whose compliance with the VP series is already confirmed are stated below. If the fitting within the applicable range is selected, there will not be any interference.

#### Applicable Fittings: KQ2H, KQ2S series

| Series                    | Piping port | Port size | Applicable tubing O.D. |    |    |    |     |     |
|---------------------------|-------------|-----------|------------------------|----|----|----|-----|-----|
|                           |             |           | ø3.2                   | ø4 | ø6 | ø8 | ø10 | ø12 |
| VP(A)300                  | 1P, 2A, 3R  | 1/8, 1/4  | [Shaded]               |    |    |    |     |     |
|                           | X           | M5        | [Shaded]               |    |    |    |     |     |
| VP(A)500                  | 1P, 2A, 3R  | 1/4, 3/8  | [Shaded]               |    |    |    |     |     |
|                           | X           | 1/8       | [Shaded]               |    |    |    |     |     |
| VP(A)700                  | 1P, 2A, 3R  | 3/8, 1/2  | [Shaded]               |    |    |    |     |     |
|                           | X           | 1/8       | [Shaded]               |    |    |    |     |     |
| VV3P(A)3<br>Manifold base | 1P, 2A, 3R  | 1/4       | [Shaded]               |    |    |    |     |     |
|                           | X           | M5        | [Shaded]               |    |    |    |     |     |
| VV3P(A)5<br>Manifold base | 1P, 2A, 3R  | 3/8       | [Shaded]               |    |    |    |     |     |
|                           | X           | M5        | [Shaded]               |    |    |    |     |     |
| VV3P(A)7<br>Manifold base | 1P, 2A, 3R  | 1/2       | [Shaded]               |    |    |    |     |     |
|                           | X           | 1/8       | [Shaded]               |    |    |    |     |     |