

# Rectangular Multi-connector **KDM Series**

No. of Connecting Tubes: 10, 20

RoHS

**Multi-connector is effective in saving labor for separate transportation of the panel and the machine, and for exchanging units due to failure.**

**Substantial reduction in mounting space**

In comparison with a model requiring many union joints for panels and partitions, this model needs only a small space.

**One-touch connection/disconnection of connector**

Multiple pipes can be connected/disconnected in one-touch operation without connection error. Thus man-hours for connection/disconnection are cut down substantially.

**One-touch tube connection**

One-touch fittings substantially cuts down man-hours for piping.

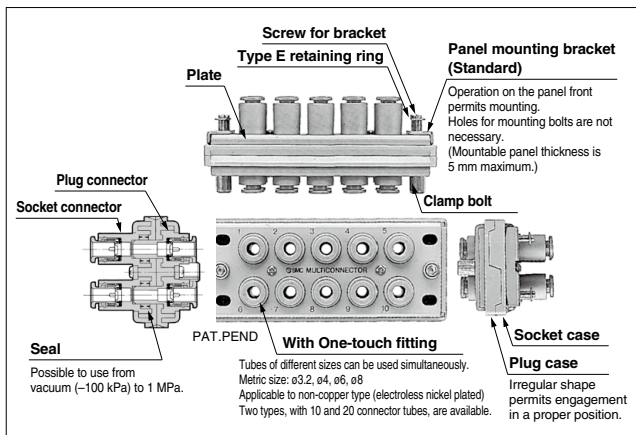

## Model

No. of connecting tubes	Tubing O.D.	Model	Weight (g)	Color of release button
10	$\phi 3.2$	KDM10-23	300	Blue
	$\phi 4$	KDM10-04		
	$\phi 6$	KDM10-06	520	
	$\phi 8$	KDM10-08		
20	$\phi 3.2$	KDM20-23	520	
	$\phi 4$	KDM20-04		
	$\phi 6$	KDM20-06	950	
	$\phi 8$	KDM20-08		

## Applicable Tubing

Tubing material	FEP, PFA, Nylon, Soft nylon, Polyurethane
Tubing O.D.	$\phi 3.2$ , $\phi 4$ , $\phi 6$ , $\phi 8$

## Specifications

Fluid	Air
Operating pressure range <sup>(Note)</sup>	-100 kPa to 1 MPa
Proof pressure	1.5 MPa
Ambient and fluid temperature	-5 to 60°C (No freezing)

(Note) Please avoid using in a vacuum holding application such as a leak tester, since there is leakage.

## ⚠ Caution

Be sure to read this before handling the products.  
Refer to back page 50 for Safety Instructions and pages 13 to 17 for Fittings and Tubing Precautions.

**Made to Order**  
(Refer to page 254 for details.)

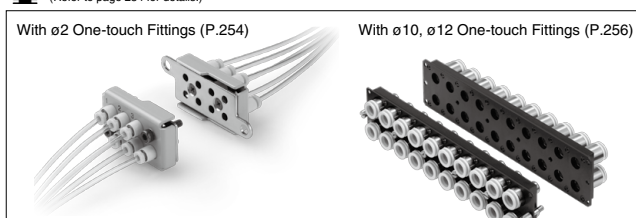

KQ2

KQB2

KS  
KX

KM

KF

M

H/DL  
L/LL

KC

KK

KK130

DM

KDM

KB

KR

KA

KQG2

KG

KFG2

MS

KKA

KP

LQ

MQR

T

IDK

# KDM Series

## Principal Parts Material

Plug case, Socket case		POM
Plate, Bracket		SPCC plated
Plug connector, Socket connector	Body	PBT, C3604 Electroless nickel plated (ø8)
	Chuck	Stainless steel 304
	Guide	Stainless steel 304, C3604 Electroless nickel plated, PBT (ø8)
	Collet, Release button	POM
	Seal	NBR
Clamp bolt, Screw for bracket, Cross-recessed head machine screw		SWRM (Nickel plated)
Type E retaining ring		Stainless steel 304

## Model

No. of connection tubes	Tubing O.D.	Model		Color of release button
		Plug	Socket	
10	ø3.2	KDM10P-23	KDM10S-23	Blue
	ø4	KDM10P-04	KDM10S-04	
	ø6	KDM10P-06	KDM10S-06	
	ø8	KDM10P-08	KDM10S-08	
20	ø3.2	KDM20P-23	KDM20S-23	
	ø4	KDM20P-04	KDM20S-04	
	ø6	KDM20P-06	KDM20S-06	
	ø8	KDM20P-08	KDM20S-08	

## Mixed Sizes of Plug Connectors and Socket Connectors

The rectangular multi-connector permits connector exchange in any desired position, thus allowing use of different sizes of tubes.

## Model

Connector	Tubing O.D.	Model	Color of release button
Plug connector	ø3.2	KDMP-23	Blue
	ø4	KDMP-04	
	ø6	KDMP-06	
	ø8	KDMP-08	
Socket connector (with seal)	ø3.2	KDMS-23	
	ø4	KDMS-04	
	ø6	KDMS-06	
	ø8	KDMS-08	

1. Loosen the cross-recessed head machine screw by using a Phillips screwdriver to remove the plate from the case.

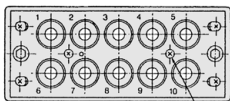

2. After exchanging connectors in desired places, fix the plate to the case by using a Phillips screwdriver.

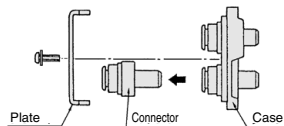

## How to Use

### ⚠ Caution

#### Separation

Loosen the clamp bolt to separate the plug side from the socket side.

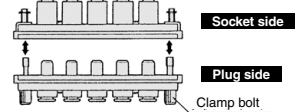

#### Connection

Put together the irregular faces for engagement and connect the plug case to the socket. After tightening the clamp bolt by hand, tighten it further with allen wrench (nominal width across flats: 4).

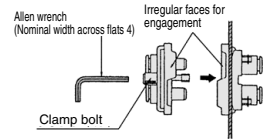

#### Panel mounting

1. Loosen (4) screws for bracket on the socket side using a Phillips screwdriver (JIS nominal No. 2) until the bracket touches the stop ring.

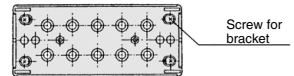

2. Shift the panel mounting bracket to the inside (Move the screw for bracket in the longitudinal direction of the slot) and put the connector in the panel mounting hole. (Panel-mounting hole: See Dimensions.)

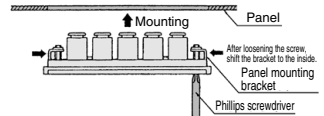

3. After shifting the bolt for bracket to the outside, tighten the bolt by a Phillips screwdriver to fix the socket case.

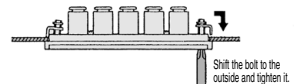

4. Loosen the screw for bracket until the bracket touches the stop ring and shift the bracket to the inside to remove the connector from the panel.

**Dimensions**



**KDM10**

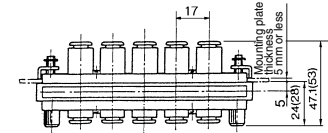

( ): Dimensions for KDM10-08

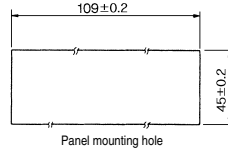
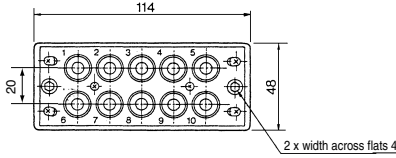

**KDM20**

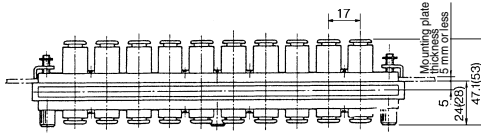

( ): Dimensions for KDM20-08

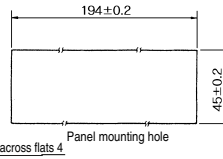
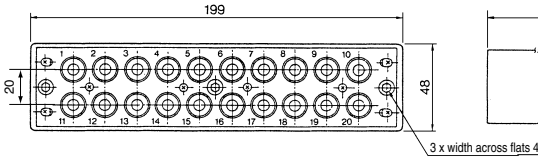

[Click here for applicable color caps.](#)

<b>KQ2</b>
<b>KQB2</b>
<b>KS</b> <b>KX</b>
<b>KM</b>
<b>KF</b>
<b>M</b>
<b>H/DL</b> <b>L/LL</b>
<b>KC</b>
<b>KK</b>
<b>KK130</b>
<b>DM</b>
<b>KDM</b>
<b>KB</b>
<b>KR</b>
<b>KA</b>
<b>KQG2</b>
<b>KG</b>
<b>KFG2</b>
<b>MS</b>
<b>KKA</b>
<b>KP</b>
<b>LQ</b>
<b>MQR</b>
<b>T</b>
<b>IDK</b>

Please contact SMC for detailed dimensions, specifications and lead times.

## 1 Grease-free Specifications

Symbol	Specifications
<b>X17</b>	Grease-free Rubber material: NBR (With fluorine coating) Release button color: Light blue
<b>X39</b>	Grease-free Rubber material: NBR (With fluorine coating) Release button color: Light blue Clean (Copper-free, air blow, double package)

Suffix "-X17" to the end of part number.

Example) **KDM10-04-X17**

## 2 Other Specifications

Symbol	Specifications
<b>X12</b>	Lubricant: White Vaseline Release button color: White

## 3 Mixed Tubing Size Type

Tubes of different sizes can be used simultaneously.

- Tubing size:  $\phi 3.2$ ,  $\phi 4$ ,  $\phi 6$ ,  $\phi 8$
- Number of connecting tubes: 10, 20

## 4 Other Tubing Size

Tubing size O.D.	Connection no.	Part no.
$\phi 10$	6	IN-254-52
$\phi 12$	6	IN-254-53

## 5 With $\phi 2$ One-touch Fittings

### ● Mounting example

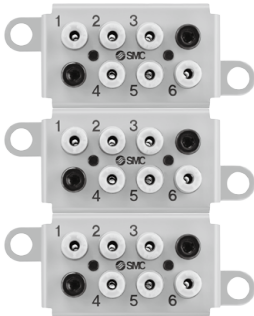

### Secure mounting

A single panel side opening for full access.

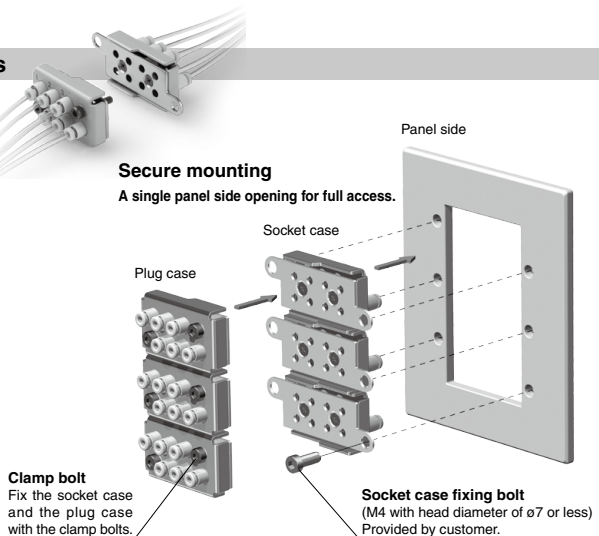

**5 With  $\phi 2$  One-touch Fittings**

**Model**

No. of connecting tubes	Tubing O.D.	Model	Weight	Release button color
6	$\phi 2$	<b>KDM6-02-X955-1</b>	42.6 g	Light gray

**Applicable Tubing**

Tubing material	Nylon, Soft nylon, Polyurethane
Tubing O.D.	$\phi 2$

**Specifications**

<b>Fluid</b>	Air
<b>Operating pressure range</b> <sup>Note)</sup>	-100 kPa to 1 MPa
<b>Proof pressure</b>	1.5 MPa
<b>Ambient and fluid temperature</b>	-5 to 60°C (No freezing)

Note) Please avoid using in a vacuum holding application such as a leak tester, since there is leakage.

**Dimensions/Construction**

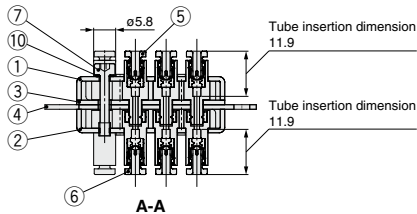
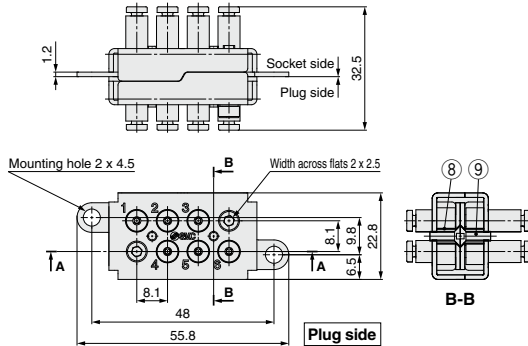

**Component Parts**

No.	Description	Material	Q'ty	Note
1	Case (A)	SPCC	1	Gray semi-gloss baking finish after zinc chromate plating
2	Case (B)	SPCC	1	Gray semi-gloss baking finish after zinc chromate plating
3	Plate (A)	Stainless steel 304	1	
4	Plate (B)	Stainless steel 304	1	
5	Plug connector $\phi 2$		6	Release button: Light gray
6	Socket connector $\phi 2$		6	Release button: Light gray
7	Hexagon socket head cap screw	SCM435	2	Black zinc chromated
8	Spacer	C2700T	4	Electroless nickel plating
9	Cross recessed countersunk head screw	SWRM	4	M2.5 x 8, Black zinc chromated
10	Gasket	PVC	2	

**KQ2**  
**KQB2**  
**KS**  
**KX**  
**KM**  
**KF**  
**M**  
**H/DL**  
**L/LL**  
**KC**  
**KK**  
**KK130**  
**DM**  
**KDM**  
**KB**  
**KR**  
**KA**  
**KQG2**  
**KG**  
**KFG2**  
**MS**  
**KKA**  
**KP**  
**LQ**  
**MQR**  
**T**  
**IDK**

# KDM Series

## 5 With $\phi 2$ One-touch Fittings

### Dimensions/Construction

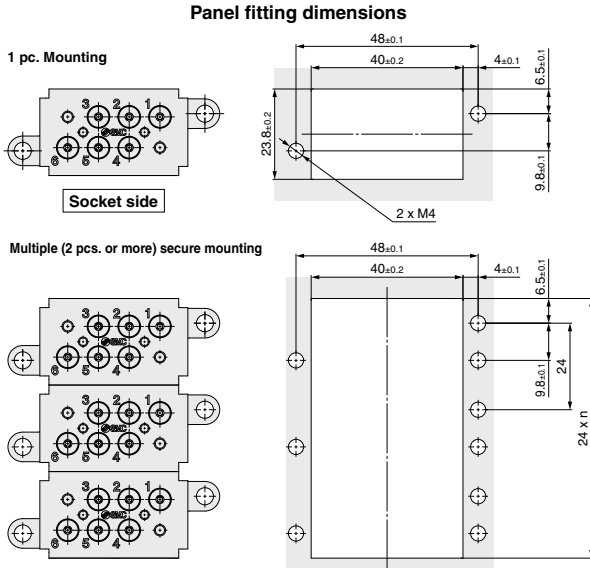

## 6 With $\phi 10, \phi 12$ One-touch Fittings



No. of connecting tubes: 6



No. of connecting tubes: 10



No. of connecting tubes: 20

### Model

No. of connecting tubes	Tubing O.D.	Model	Weight (g)	Release button color
6	$\phi 10$	KDM6-10-X1053	611	Light gray
	$\phi 12$	KDM6-12-X1053	607	
10	$\phi 10$	KDM10-10-X1053	708	
	$\phi 12$	KDM10-12-X1053	995	
20	$\phi 10$	KDM20-10-X1053	1385	
	$\phi 12$	KDM20-12-X1053	1945	

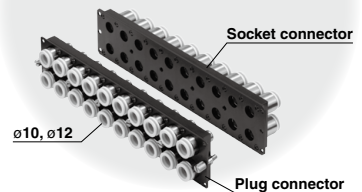

### Applicable Tubing

Tubing material	Nylon, Soft nylon, Polyurethane
Tubing O.D.	$\phi 10, \phi 12$

### Specifications

<b>Fluid</b>	Air
<b>Operating pressure range</b> <sup>(Note)</sup>	0 to 1 MPa
<b>Proof pressure</b>	1.5 MPa
<b>Ambient and fluid temperature</b>	-5 to 60°C (No freezing)

Note) Please avoid using in a vacuum holding application such as a leak tester, since there is leakage.

**6 With  $\phi 10, \phi 12$  One-touch Fittings**

**Dimensions/Construction**

**KDM6-□-X1053**

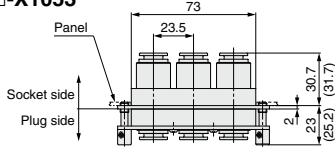

( ): Dimensions for KDM6-12-X1053

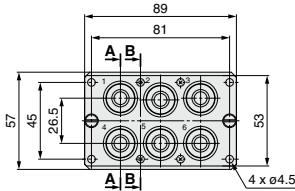

Plug side

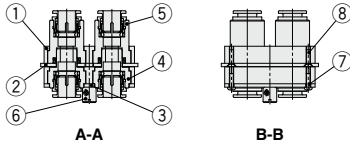

**KDM10-□-X1053**

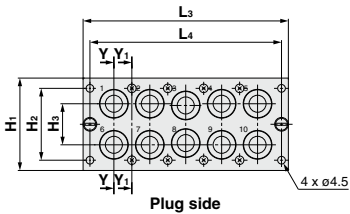
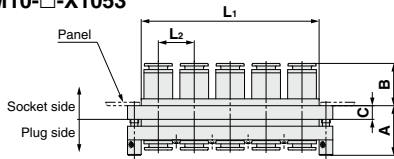

Plug side

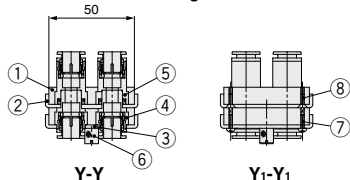

Model	A	B	C	L1	L2	L3	L4	H1	H2	H3
KDM10-10-X1053	29	24.7	8	104	21	120	112	54	42	24
KDM10-12-X1053	25.2	31.7	2	120	23.5	136	128	57	45	26.5

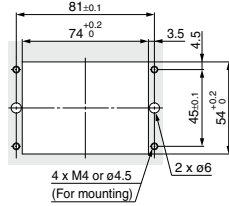

Panel mounting hole

**Component Parts**

No.	Description	Material	Quantity	Note
1	Case 6 tubes	A6063	2	Black anodized
2	Plate (A) 6 tubes	SPCC	1	Black zinc chromated
3	Plate (B) 6 tubes	SPCC	1	Black zinc chromated
4	Plug	—	6	Electroless nickel plating
5	Socket	—	6	Electroless nickel plating
6	Clamp bolt	C3604	2	Electroless nickel plating
7	Cross recessed round head screw	SWRM	4	M2.5 x 8 Black zinc chromated
8	Cross recessed countersunk head screw	SWRM	4	M2.5 x 8 Black zinc chromated

Tubing O.D.:  $\phi 10$

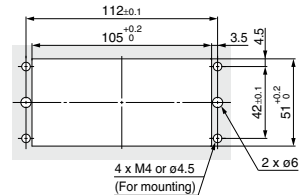

Tubing O.D.:  $\phi 12$

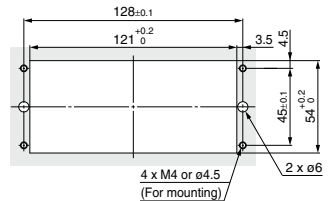

Panel mounting hole

**Component Parts**

No.	Description	Material	Quantity	Note
1	Case 10 tubes	A6063	2	Black anodized
2	Plate (A) 10 tubes	SPCC	1	Black zinc chromated
3	Plate (B) 10 tubes	SPCC	1	Black zinc chromated
4	Plug	—	10	Electroless nickel plating
5	Socket	—	10	Electroless nickel plating
6	Clamp bolt	C3604	2	Electroless nickel plating
7	Cross recessed round head screw	SWRM	8	M2.5 x 8 Black zinc chromated
8	Cross recessed countersunk head screw	SWRM	8	M2.5 x 8 Black zinc chromated

KQ2
KQB2
KS
KX
KM
KF
M
H/DL
L/L
KC
KK
KK130
DM
KDM
KB
KR
KA
KQG2
KG
KFG2
MS
KKA
KP
LQ
MQR
T
IDK

## 6 With $\phi 10$ , $\phi 12$ One-touch Fittings

### Dimensions/Construction

#### KDM20-□-X1053

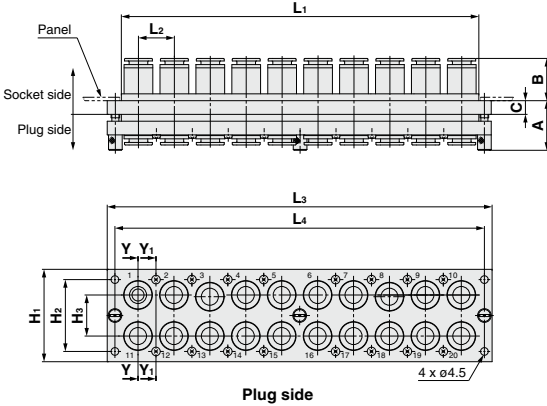

#### Tubing O.D.: $\phi 10$

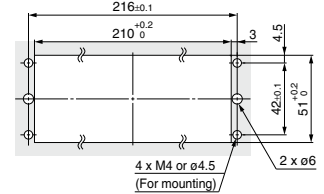

#### Tubing O.D.: $\phi 12$

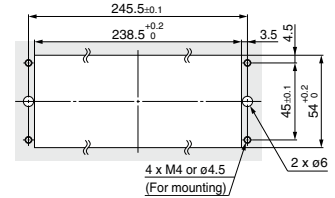

#### Panel mounting hole

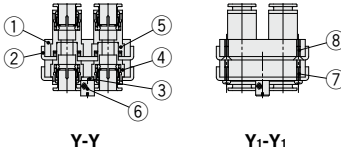

#### Component Parts

No.	Description	Material	Quantity	Note
1	Case 20 tubes	A6063	2	Black anodized
2	Plate (A) 20 tubes	SPCC	1	Black zinc chromated
3	Plate (B) 20 tubes	SPCC	1	Black zinc chromated
4	Plug	—	20	Electroless nickel plating
5	Socket	—	20	Electroless nickel plating
6	Clamp bolt	C3604	3	Electroless nickel plating
7	Cross recessed round head screw	SWRM	16	M2.5 x 8 Black zinc chromated
8	Cross recessed countersunk head screw	SWRM	16	M2.5 x 8 Black zinc chromated

Model	A	B	C	L1	L2	L3	L4	H1	H2	H3
KDM20-10-X1053	29	24.7	8	209	21	225	216	54.5	42	24
KDM20-12-X1053	25.5	31.7	2	237.5	23.5	253.5	245.5	57	45	26.5

### ⚠ Caution

1. Socket case fixing bolts (M4) and the hexagon nuts for mounting to the panel should be provided by the customer.

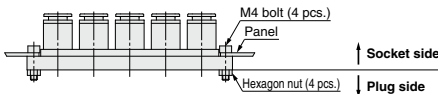

2. A flat blade screwdriver is necessary when tightening the clamp bolt after connecting the plug case to the socket case.

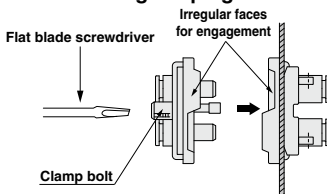



# Inch-size Rectangular Multi-connector

## **KDM Series**

No. of Connecting Tubes: 10, 20

**Multi-connector is effective in saving labor for separate transportation of the panel and the machine, and for exchanging units due to failure.**

**Substantial reduction in mounting space**

In comparison with a model requiring many union joints for panels and partitions, this model needs only a small space.

**One-touch connection/disconnection of connector**

Multiple pipes can be connected/disconnected in one-touch operation without connection error. Thus man-hours for connection/disconnection are cut down substantially.

**One-touch tube connection**

One-touch fittings substantially cuts down man-hours for piping.

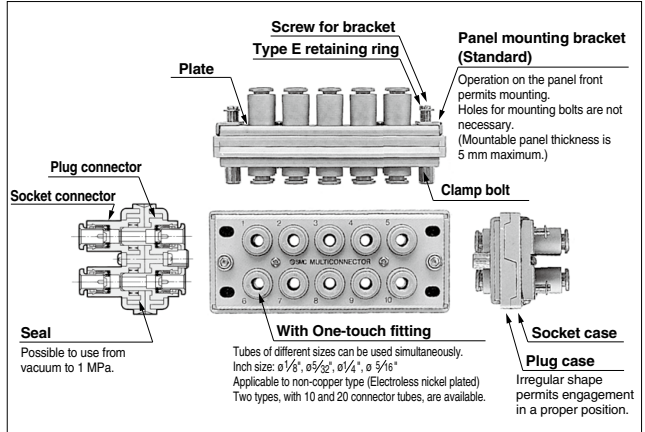
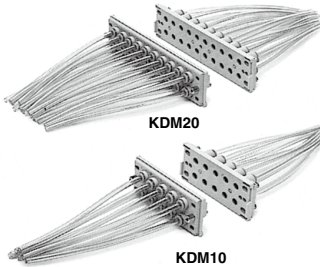

### Model

No. of connecting tubes	Tubing O.D.	Model	Weight (g)	Color of release button	
10	ø 1/8"	KDM10-01	300	Red	
	ø 5/32"	KDM10-03			
	ø 1/4"	KDM10-07			
	ø 5/16"	KDM10-09			
20	ø 1/8"	KDM20-01	520		
	ø 5/32"	KDM20-03			
	ø 1/4"	KDM20-07			
	ø 5/16"	KDM20-09			
			950		

### Applicable Tubing

Tubing material	FEP, PFA, Nylon, Soft nylon, Polyurethane
Tubing O.D.	ø 1/8", ø 5/32", ø 1/4", ø 5/16"

### Specifications

Fluid	Air
Operating pressure range <small>(Note)</small>	-100 kPa to 1 MPa
Proof pressure	1.5 MPa
Ambient and fluid temperature	-5 to 60°C (No freezing)

(Note) Please avoid using in a vacuum holding application such as a leak tester, since there is leakage.

**Made to Order**  
Made to Order  
(Refer to page 262 for details.)

KQ2  
KQB2  
KS  
KX  
KM  
KF  
M  
H/DL  
L/LL  
KC  
KK  
KK130  
DM  
KDM  
KB  
KR  
KA  
KQG2  
KG  
KFG2  
MS  
KKA  
KP  
LQ  
MQR  
T  
IDK

# KDM Series

## Principal Parts Material

Plug case, Socket case		POM
Plate, Bracket		SPCC plated
Plug connector, Socket connector	Body	PBT, C3604BD Electroless nickel plated (ø5/16)
	Chuck	Stainless steel 304
	Guide	Stainless steel 304, C3604BD Electroless nickel plated, POM (ø5/16)
	Collet, Release button	POM
	Seal	NBR
Clamp bolt, Screw for bracket, Cross-recessed head machine screw		SWRM (Nickel plated)
Type E retaining ring		Stainless steel 304

## Model

No. of connection tubes	Tubing O.D.	Model		Color of release button
		Plug	Socket	
10	ø 1/8"	KDM10P-01	KDM10S-01	Red
	ø 5/32"	KDM10P-03	KDM10S-03	
	ø 1/4"	KDM10P-07	KDM10S-07	
	ø 5/16"	KDM10P-09	KDM10S-09	
20	ø 1/8"	KDM20P-01	KDM20S-01	
	ø 5/32"	KDM20P-03	KDM20S-03	
	ø 1/4"	KDM20P-07	KDM20S-07	
	ø 5/16"	KDM20P-09	KDM20S-09	

## Mixed Sizes of Plug Connectors and Socket Connectors

The rectangular multi-connector permits connector exchange in any desired position, thus allowing use of different sizes of tubes.

## Model

Connector	Tubing O.D.	Model	Color of release button
Plug connector	ø 1/8"	KDMP-01	Red
	ø 5/32"	KDMP-03	
	ø 1/4"	KDMP-07	
	ø 5/16"	KDMP-09	
Socket connector (with seal)	ø 1/8"	KDMS-01	
	ø 5/32"	KDMS-03	
	ø 1/4"	KDMS-07	
	ø 5/16"	KDMS-09	

- Loosen the cross-recessed head machine screw by using a Phillips screwdriver to remove the plate from the case.
- After exchanging connectors in desired places, fix the plate to the case by using a Phillips screwdriver.

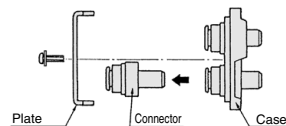
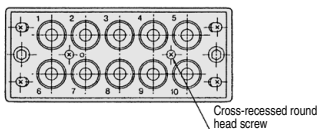

## How to Use

### ⚠ Caution

#### Separation

Loosen the clamp bolt to separate the plug side from the socket side.

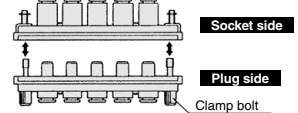

#### Connection

Put together the irregular faces for engagement and connect the plug case to the socket. After tightening the clamp bolt by hand, tighten it further with allen wrench (nominal width across flats: 4).

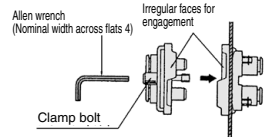

#### Panel mounting

- Loosen (4) screws for bracket on the socket side using a Phillips screwdriver (JIS nominal No. 2) until the bracket touches the stop ring.

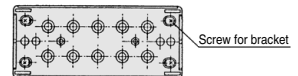

- Shift the panel mounting bracket to the inside (Move the screw for bracket in the longitudinal direction of the slot) and put the connector in the panel mounting hole. (Panel-mounting hole: See Dimensions.)

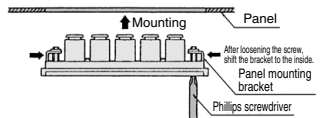

- After shifting the bolt for bracket to the outside, tighten the bolt by a Phillips screwdriver to fix the socket case.

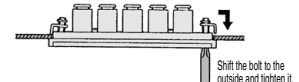

- Loosen the screw for bracket until the bracket touches the stop ring and shift the bracket to the inside to remove the connector from the panel.



**Dimensions**

**KDM10**

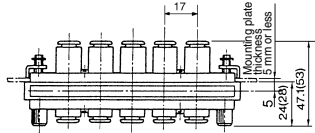

( ): Dimensions for KDM10-09

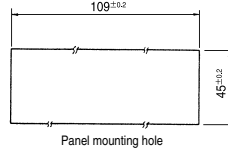
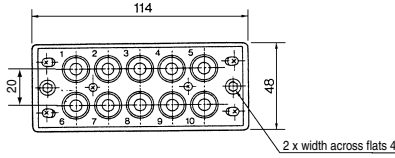

**KDM20**

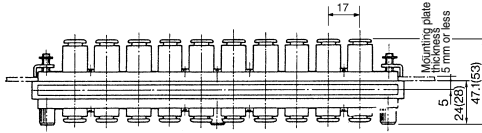

( ): Dimensions for KDM20-09

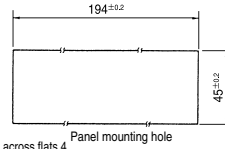
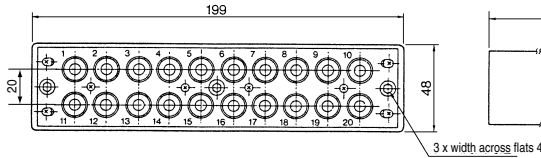

[Click here for applicable color caps.](#)

**Handling of One-touch Fittings**

**⚠ Caution**

Refer to "Fittings & Tubing Precautions" for the details of installation/removal of One-touch fittings on the pages 13 to 17.

KQ2
KQB2
KS KX
KM
KF
M
H/DL L/LL
KC
KK
KK130
DM
<b>KDM</b>
KB
KR
KA
KQG2
KG
KFG2
MS
KKA
KP
LQ
MQR
T
IDK



## 1 Grease-free Specifications

Symbol	Specifications
<b>X17</b>	Grease-free Rubber material: NBR (With fluorine coating) Release button color: Light blue
<b>X39</b>	Grease-free Rubber material: NBR (With fluorine coating) Release button color: Light blue Clean (Copper-free, air blow, double package)

Suffix "-X17" to the end of part number.

Example) **KDM10-03-X17**

## 2 Other Specifications

Symbol	Specifications
<b>X12</b>	Lubricant: White Vaseline Release button color: White

## 3 Mixed Tubing Size Type

**Tubes of different sizes can be used simultaneously.**

- Tubing size:  $\phi 1/8"$ ,  $\phi 5/32"$ ,  $\phi 1/4"$ ,  $\phi 5/16"$
- Number of connecting tubes: 10, 20