

Stainless Steel Cylinder

CJ5-S Series CG5-S Series

ø10, ø16

ø20, ø25, ø32, ø40, ø50, ø63, ø80, ø100

Applicable for use in an environment with water splashing such as food processing, etc.

CJ5
CG5

HY□

Water
Resistant

For use with grease for food processing machines (Approved by NSF-H1)

All stainless steel specifications (External parts)

Stainless steel 304 is used for external metal parts. Corrosion resistance is improved even in environments with exposure to water.

Special scraper (Standard)

Prevents water from entering the cylinder.

Relation of Liquid Entry and Sliding Distance

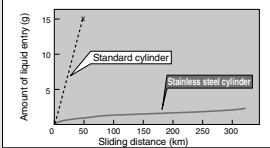

Conditions

Working fluid..... Air
Pressure 0.5 MPa
Liquid Water-soluble coolant
Piston speed 200 mm/s
Operating frequency... 60 cpm



Special scraper

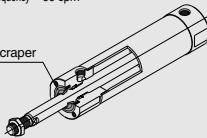

Two types of seal material

(Nitrile rubber) (Fluororubber)

NBR or FKM can be selected to accommodate the application.

Can be disassembled (CG5-S series ø20 to 40)

Since seals are replaceable, this extends the life of the cylinder.

(Before disassembly, be sure to refer to the section regarding maintenance under "Specific Product Precautions" on page 1080.)

Exterior configuration reduces residual liquid

- Electropolishing of mounting bracket surfaces makes them smoother to prevent build-up of liquids and foreign matter.
- Plugs are provided for unused mounting threads (CG5-S series) to prevent residue build-up in the threads.



This product cannot be used in the food zone. Refer to the Product Specific Precautions (page 1079) for details.

Series Variations

Series	Seal material	Type	Bore size (mm)								Applicable auto switch		
			10	16	20	25	32	40	50	63		80	100
CJ5-S	NBR	Single rod	●	●									Water resistant D-H7BAL
		Double rod											
CG5-S	FKM	Single rod			●	●	●	●	●	●	●	●	Water resistant D-G5BAL
		Double rod			●	●	●	●	●	●	●	●	

D-□

-X□

Technical
Data

Stainless Steel Cylinder

CJ5-S Series

ø10, ø16

How to Order

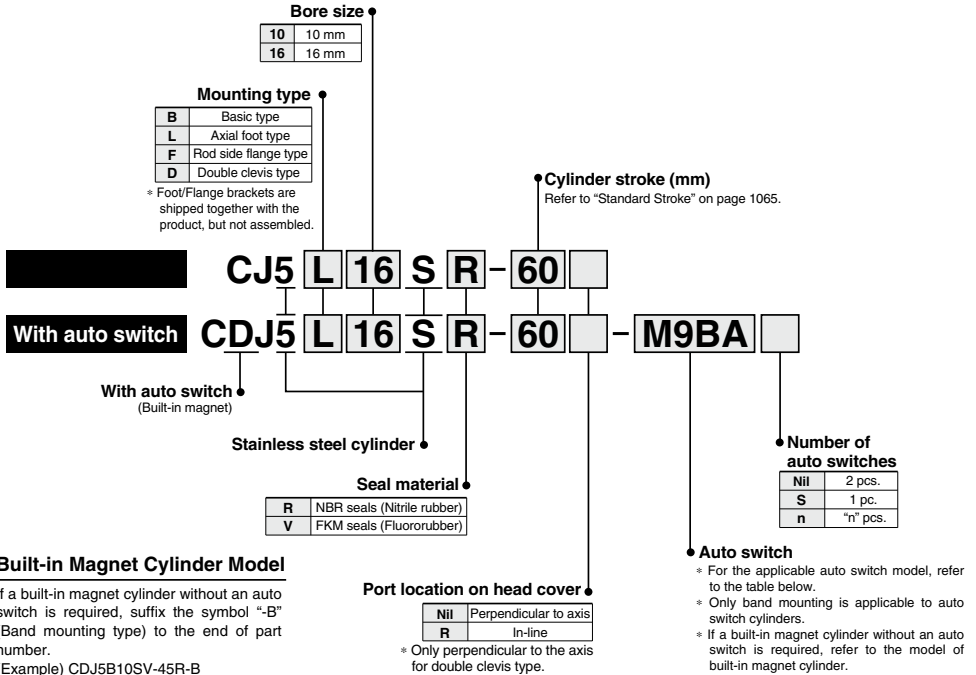

Applicable Auto Switches

Refer to pages 1575 to 1701 for further information on auto switches.

Type	Special function	Electrical entry	Indicator light	Wiring (Output)	Load voltage		Auto switch model		Lead wire length (m)*					Pre-wired connector	Applicable load	
					DC	Band mounting(ø10, ø16)	0.5 (Nil)	1 (M)	3 (L)	5 (Z)	IC circuit	Relay, PLC				
													Perpendicular		In-line	
Solid state auto switch	Water resistant (2-color indicator)	Grommet	Yes	3-wire(NPN)	24 V	5 V, 12 V	M9NAV	M9NA	○	○	●	○	○	—	—	
				3-wire(PNP)					○	○	●	○				
				2-wire					○	○	●	○				

* Lead wire length symbols: Nil0.5 m (Example) D-M9NA
M1 m (Example) D-M9NAM
L3 m (Example) D-M9NAL
Z5 m (Example) D-M9NAZ

* Solid state auto switches marked with "○" are produced upon receipt of order.

* For details about auto switches with pre-wired connector, refer to pages 1648 and 1649.

Mounting Bracket Part No.

Mounting bracket	Bore size (mm)		Description
	10	16	
Foot	CJ-L016 Stainless steel	CJK-L016 Stainless steel	Foot x 1
Flange	CJ-F016 Stainless steel	CJK-F016 Stainless steel	Flange x 1
T-bracket*	CJ-T010 Stainless steel	CJ-T016 Stainless steel	T-bracket x 1

* T-bracket is applicable to the double clevis type (D).

Specifications



Symbol

Double acting,
Single rod, Rubber bumper

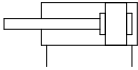

Bore size (mm)	10	16
Action	Double acting, Single rod	
Fluid	Air	
Proof pressure	1 MPa	
Maximum operating pressure	0.7 MPa	
Minimum operating pressure	0.1 MPa	
Ambient and fluid temperature	Without auto switch: -10 to 70°C With auto switch: -10 to 60°C	
Cushion	Rubber bumper	
Lubrication	Not required (Non-Lube)	
Stroke length tolerance	+1.0 0	
Piston speed	50 to 750 mm/s	
Allowable kinetic energy	0.035 J	0.090 J
Mounting type	Basic type, Axial foot type, Rod side flange type, Double clevis type	

CJ5
CG5

HY□

Water
Resistant

Standard Stroke

(mm)

Bore size (mm)	Standard stroke	Maximum manufacturable stroke
10	15, 30, 45, 60, 75, 100, 125, 150	400
16	15, 30, 45, 60, 75, 100, 125, 150, 175, 200	

* Manufacture of intermediate strokes at 1 mm intervals is possible. (Spacers are not used.)

* For the one with auto switch, refer to the minimum stroke for auto switch mounting. (P. 1077)

Mounting Type and Accessory

●: Supplied with the product. ○: Please order separately.

Mounting		Basic type	Axial foot type	Rod side flange type	Double clevis type *
Standard equipment	Mounting nut	●	●	●	—
	Rod end nut	●	●	●	●
	Clevis pin	—	—	—	●
Option	Single knuckle joint	○	○	○	○
	Double knuckle joint (With pin) *	○	○	○	○
	T-bracket	—	—	—	○
	Rod end cap	Flat type	○	○	○
Round type		○	○	○	○

* Pin and retaining ring are shipped together with double clevis and double knuckle joint.

Weight

(g)

Bore size (mm)		10	16
Basic weight *		52	96
Additional weight per each 15 mm of stroke		4	6.5
Mounting bracket weight	Axial foot type	22	22
	Rod side flange type	16	16
	Double clevis type (With pin) **	6	16

* Mounting nut and rod end nut are included in the basic weight.

** Mounting nut is not included in double clevis type.

Calculation: (Example) **CJ5L10SR-45**

- Basic weight 52 g (ø10)
- Additional weight 4 g/15 stroke
- Cylinder stroke 45 stroke
- Mounting bracket weight 22 g (Axial foot type)
52 + 4/15 × 45 + 22 = 86 g

D-□

-X□

Technical
Data

CJ5-S Series

Construction (Not able to disassemble.)

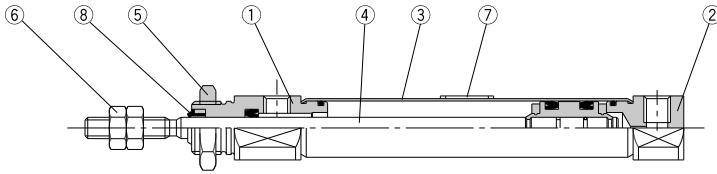

Component Parts

No.	Description	Material	
1	Rod cover	Stainless steel 304	
2	Head cover	Stainless steel 304	
3	Cylinder tube	Stainless steel 304	
4	Piston rod	Stainless steel 304	
5	Mounting nut	Stainless steel 304	
6	Rod end nut	Stainless steel 304	
7	Label protector	PET	
8	Water resistant scraper	CJ5□□SR	NBR
		CJ5□□SV	FKM

Note) Component part material and surface treatment other than listed above are the same as the standard type of the CJ2 series.

Dimensions

Basic type (B): C□J5B□S ^R_V

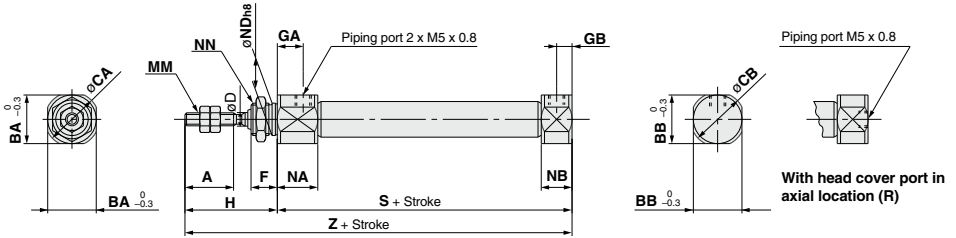

CJ5
CG5
HY□
Water
Resistant

(mm)

Bore size (mm)	A	BA	BB	CA	CB	D	F	GA	GB	H	MM	NN	NA	NB	NDh8	S	Z
10	15	15	12	17	14	4	8	8	5	28	M4 x 0.7	M10 x 1.0	12.5	9.5	10 ⁰ _{-0.022}	46	74
16	15	18.3	18.3	20	20	5	8	8	5	28	M5 x 0.8	M12 x 1.0	12.5	9.5	12 ⁰ _{-0.027}	47	75

Axial foot type (L): C□J5L□S ^R_V

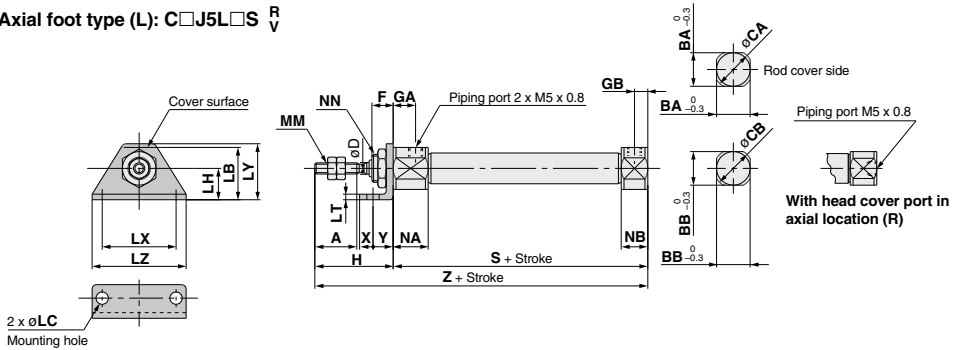

(mm)

Bore size (mm)	A	BA	BB	CA	CB	D	F	GA	GB	H	LB	LC	LH	LT	LX	LY	LZ	MM	NN	NA	NB	S	X	Y	Z
10	15	15	12	17	14	4	8	8	5	28	21.5	5.5	14	2.5	33	25	42	M4 x 0.7	M10 x 1.0	12.5	9.5	46	6	9	74
16	15	18.3	18.3	20	20	5	8	8	5	28	23	5.5	14	2.5	33	25	42	M5 x 0.8	M12 x 1.0	12.5	9.5	47	6	9	75

D-□
-X□
Technical
Data

CJ5-S Series

Dimensions

Rod side flange type (F): C□J5F□S^R_V

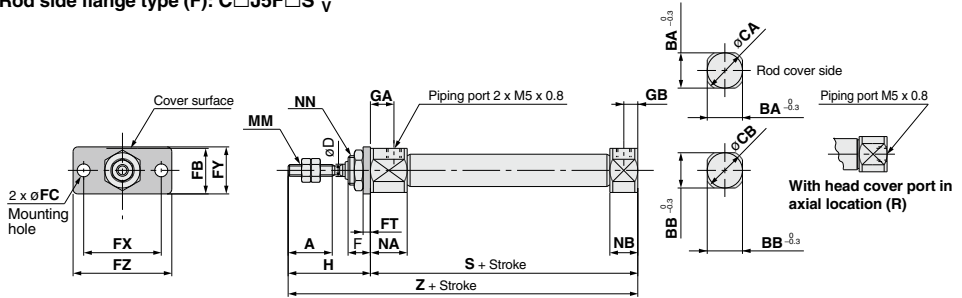

Bore size (mm)	A	BA	BB	CA	CB	D	F	FB	FC	FT	FX	FY	FZ	GA	GB	H	MM	NN	NA	NB	S	Z
10	15	15	12	17	14	4	8	17.5	5.5	2.5	33	20	42	8	5	28	M4 x 0.7	M10 x 1.0	12.5	9.5	46	74
16	15	18.3	18.3	20	20	5	8	19	5.5	2.5	33	20	42	8	5	28	M5 x 0.8	M12 x 1.0	12.5	9.5	47	75

Double clevis type (D): C□J5D□S^R_V

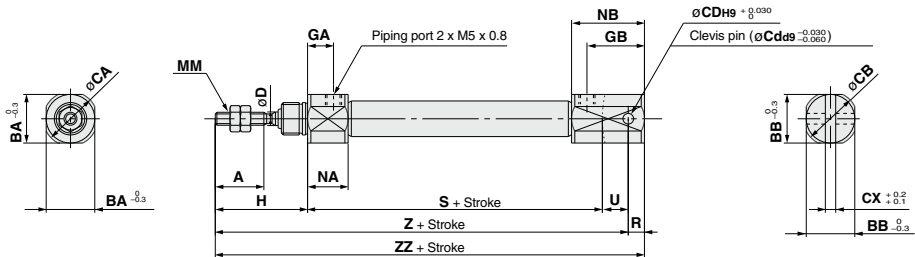

Bore size (mm)	A	BA	BB	CA	CB	CD (Cd)	CX	D	GA	GB	H	MM	NA	NB	R	S	U	Z	ZZ
10	15	15	12	17	14	3.3	3.2	4	8	18	28	M4 x 0.7	12.5	22.5	5	46	8	82	87
16	15	18.3	18.3	20	20	5	6.5	5	8	23	28	M5 x 0.8	12.5	27.5	8	47	10	85	93

* Clevis pin and retaining ring are shipped together.

Stainless Steel Cylinder: Standard Type

Double Acting, Single Rod

CG5-S Series

ø20, ø25, ø32, ø40, ø50, ø63, ø80, ø100

How to Order

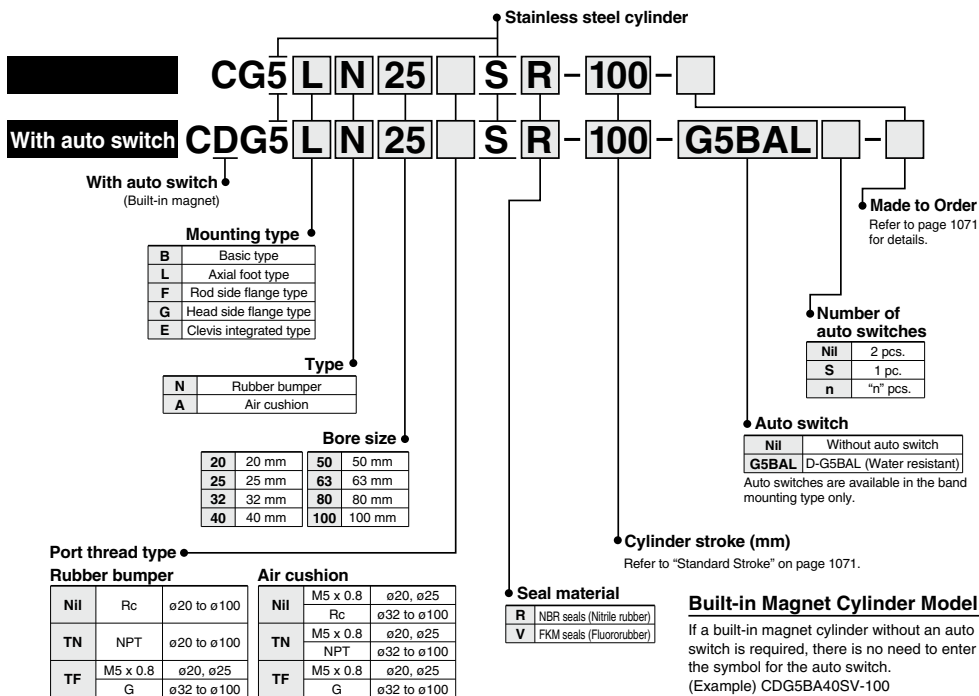

Applicable Auto Switches/Refer to pages 1575 to 1701 for further information on auto switches.

Type	Special function	Electrical entry	Indicator light	Wiring (Output)	Load voltage		Auto switch model	Lead wire length (m)*		Pre-wired connector	Applicable load
					DC			3 (L)	5 (Z)		
Solid state auto switch	Water resistant (2-color indicator)	Grommet	Yes	2-wire	24 V	12 V	G5BA	●	○	○	Relay, PLC

* Lead wire length symbols: 3 m.....L (Example) G5BAL
5 m.....Z (Example) G5BAZ

* Solid state auto switches marked with "○" are produced upon receipt of order.

• For details about auto switches with pre-wired connector, refer to pages 1648 and 1649.

Mounting Bracket Part No.

Mounting bracket	Min. order	Bore size (mm)								Description
		20	25	32	40	50	63	80	100	
Axial foot	2 (Nil)	CG-L020SUS	CG-L025SUS	CG-L032SUS	CG-L040SUS	CG-L050SUS	CG-L063SUS	CG-L080SUS	CG-L100SUS	Foot x 2 Bracket mounting bolt x 4
Flange	1	CG-F020SUS	CG-F025SUS	CG-F032SUS	CG-F040SUS	CG-F050SUS	CG-F063SUS	CG-F080SUS	CG-F100SUS	Flange x 1 Bracket mounting bolt x 4
Pivot bracket	1	CG-E020SUS		CG-E032SUS		CG-E050SUS		CG-E080SUS		Clevis pin x 1 Retaining ring x 2

Note) When ordering the foot bracket, order 2 pcs. per cylinder.

Stainless Steel Cylinder: Standard Type **CG5-S Series**

Specifications



Symbol

Double acting,
Single rod, Rubber bumper

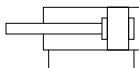

Air cushion

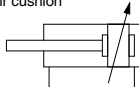

Made to Order Specifications
[Click here for details](#)

Symbol	Specifications
-XA□	Change of rod end shape
-XB6	Heat resistant cylinder (150°C)*

* Heat resistant grease (non-food grease) is used.

Bore size (mm)	20	25	32	40	50	63	80	100
Action	Double acting, Single rod							
Fluid	Air							
Proof pressure	1.5 MPa							
Maximum operating pressure	1.0 MPa							
Minimum operating pressure	0.05 MPa							
Ambient and fluid temperature	Without auto switch: -10 to 70°C With auto switch: -10 to 60°C							
Cushion	Rubber bumper, Air cushion							
Lubrication	Not required (Non-lube)							
Piston speed	50 to 1000 mm/s						50 to 700 mm/s	
Stroke length tolerance	Up to 1000 st +1.4 ₀ mm, Up to 1500 st +1.8 ₀ mm							
Mounting type	Basic type, Axial foot type, Rod side flange type, Head side flange type, Clevis integrated type							

Standard Stroke

(mm)

Bore size	Standard stroke ^{Note 1)}	Maximum manufacturable stroke ^{Note 2)}
20	25, 50, 75, 100, 125, 150, 200	201 to 1500
25	25, 50, 75, 100, 125, 150, 200, 250, 300	301 to 1500
32		
40		
50		
63		
80		
100		

Note 1) Other intermediate strokes can be manufactured upon receipt of order. Manufacture of intermediate strokes in 1 mm increments is possible. (Spacers are not used.)

Note 2) The maximum manufacturable stroke shows the long stroke.

Note 3) Applicable strokes should be confirmed according to the usage. For details, refer to "Air Cylinders Model Selection" on front matter pages. In addition, the products that exceed the standard stroke might not be able to fulfill the specifications due to the deflection etc.

Accessory

●: Supplied with the product. ○: Please order separately.

Mounting		Basic type	Axial foot type	Rod side flange type	Head side flange type	Clevis integrated type
Standard equipment	Rod end nut	●	●	●	●	●
	Single knuckle joint	○	○	○	○	○
Option	Double knuckle joint (With pin & retaining ring)	○	○	○	○	○
	Pivot bracket (With pin and retaining ring)	—	—	—	—	○

Weight

(kg)

Bore size (mm)		20	25	32	40	50	63	80	100
Basic weight	Basic type	0.34	0.42	0.59	1.03	1.84	2.81	5.27	8.25
	Axial foot type	0.49	0.59	0.77	1.25	2.24	3.35	6.05	9.70
	Flange type	0.44	0.51	0.69	1.16	2.16	3.28	5.86	9.30
	Clevis integrated type	0.40	0.48	0.72	1.21	2.30	3.40	6.83	10.28
Pivot bracket		0.08	0.08	0.18	0.18	0.46	0.46	1.65	1.65
Single knuckle joint		0.04	0.07	0.07	0.11	0.22	0.22	0.53	0.78
Double knuckle joint (with pin)		0.05	0.09	0.09	0.18	0.33	0.33	0.73	1.07
Additional weight per each 50 mm of stroke		0.06	0.08	0.14	0.18	0.27	0.33	0.50	0.73
Additional weight with air cushion		0.02	0.02	0.02	0.02	0.05	0.10	0.22	0.24

Calculation: (Example) **CG5LA 20SR-100**
(Foot type ø20, 100 stroke)

- Basic weight 0.49 kg (Foot type ø20)
- Additional stroke weight 0.06 kg/50 ST
- Air cylinder stroke 100 ST
- Additional air cushion weight 0.02 kg
- 0.49 + 0.06 x 100/50 + 0.02 = 0.63 kg

CG5-S Series

Construction

With rubber bumper

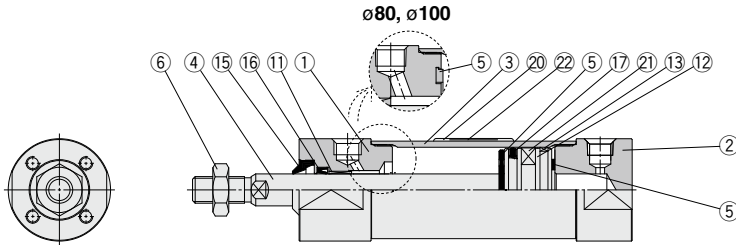

With air cushion

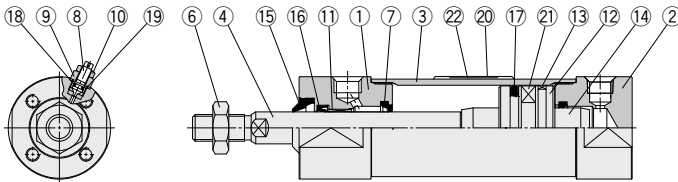

Component Parts

No.	Description	Material	Note
1	Rod cover	Stainless steel	
2	Head cover	Stainless steel	
3	Cylinder tube	Stainless steel	
4	Piston rod	Stainless steel	Hard chrome plated
5	Bumper	Urethane	
6	Rod end nut	Stainless steel	
7	Cushion seal	Urethane	
8	Cushion valve	Stainless steel	
9	Valve retainer	Stainless steel	
10	Lock nut	Stainless steel	
11	Bushing	Bearing alloy	
12	Piston	Aluminum alloy	
13	Wearing ring	Resin	
14	Cushion ring	Aluminum alloy	

Note 1) Component part material and surface treatment other than listed above are the same as the standard type of the CG1 series.

Note 2) For cylinders with an auto switch, the piston is fixed with a magnet.

No.	Description	Material	
		CG5□□SR	CG5□□SV
15	Water resistant scraper	NBR	FKM
16	Rod seal		
17	Piston seal		
18	Valve seal		
19	Valve retainer gasket		
20	Label protector	PET	
21	Magnet	—	
22	Label	—	

Replacement Parts/Seal Kit

Bore size (mm)	Rubber bumper		Air cushion	
	CG5□□SR	CG5□□SV	CG5□□SR	CG5□□SV
20	CG5N20SR-PS	CG5N20SV-PS	CG5A20SR-PS	CG5A20SV-PS
25	CG5N25SR-PS	CG5N25SV-PS	CG5A25SR-PS	CG5A25SV-PS
32	CG5N32SR-PS	CG5N32SV-PS	CG5A32SR-PS	CG5A32SV-PS
40	CG5N40SR-PS	CG5N40SV-PS	CG5A40SR-PS	CG5A40SV-PS
Contents	Set of 16 and 17 above		Set of 16, 17, 18 and 19 above	

* As sizes $\varnothing 50$ and larger cannot be disassembled, the seal cannot be replaced. (Refer to page 1080 for details.)

* Seal kit includes a grease pack (10 g).

Order with the following part number when only the grease pack is needed.

Grease pack for stainless steel cylinders/Part no.: GR-R-010 (10 g)

Dimensions

Basic type (B): C□G5BN□S^R₁: With rubber bumper

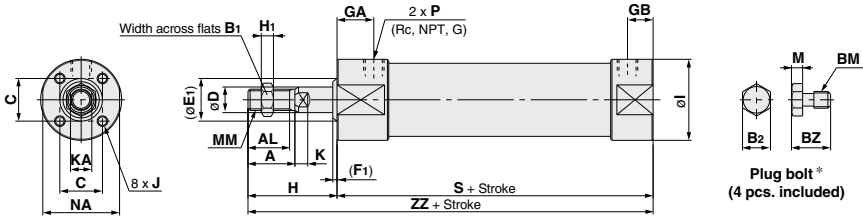

CJ5
CG5
HY□
Water
Resistant

Plug bolt*
(4 pcs. included)

Bore size (mm)	Stroke range	(mm)																								
		A	AL	B1	B2	BM	BZ	C	D	E1	F1	GA	GB	H	H1	I	J	K	KA	M	MM	NA	P		S	ZZ
	Standard	Rc, NPT, G																								
20	Up to 1500	18	15.5	13	7	M4 x 0.7	9	16.5	8	15	3	18	12	35	5	31	M4 x 0.7 depth 7	5	6	3	M8 x 1.25	29	1/8	M5 x 0.8	83	118
25		22	19.5	17	8	M5 x 0.8	9.5	18.5	10	17	3	18	12	40	6	33	M5 x 0.8 depth 8	5.5	8	3.5	M10 x 1.25	29	1/8	M5 x 0.8	83	123
32		22	19.5	17	8	M5 x 0.8	9.5	20	12	19	3	18	12	40	6	38	M5 x 0.8 depth 8	5.5	10	3.5	M10 x 1.25	35.5	1/8	1/8	85	125
40		30	27	19	10	M6 x 1.0	12	26	16	23	3	19	13	50	8	47	M6 x 1.0 depth 12	6	14	4	M14 x 1.5	44	1/8	1/8	93	143
50		35	32	27	13	M8 x 1.25	15.5	32	20	28	3	21	14	58	11	58	M8 x 1.25 depth 16	7	18	5.5	M18 x 1.5	55	1/4	1/4	109	167
63		35	32	27	17	M10 x 1.5	19	38	20	28	3	21	14	58	11	72	M10 x 1.5 depth 16	7	18	7	M18 x 1.5	69	1/4	1/4	109	167
80		40	37	32	17	M10 x 1.5	19	50	25	33	3	28	20	71	13	89	M10 x 1.5 depth 22	10	22	7	M22 x 1.5	80	3/8	3/8	130	201
100		40	37	41	19	M12 x 1.75	24	60	30	38	3	29	20	71	16	110	M12 x 1.75 depth 23	10	26	8	M26 x 1.5	100	1/2	1/2	131	202

* Install plug bolts, which are included, in any unused mounting holes.

Basic type (B): C□G5BA□S^R₁: With air cushion

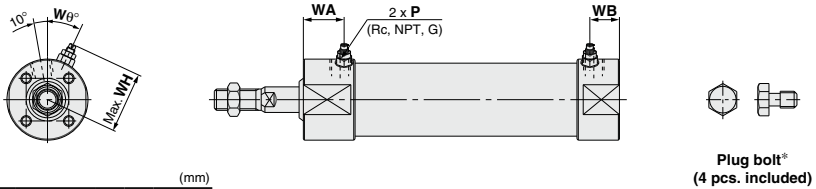

Plug bolt*
(4 pcs. included)

Bore size (mm)	Stroke range	(mm)				
		P	WA	WB	WH	Wθ
	Standard	Rc, NPT, G				
20	Up to 1500	M5 x 0.8	22	16	23	30°
25		M5 x 0.8	22	16	25	30°
32		1/8	22	16	28.5	25°
40		1/8	24	18	33	20°
50		1/4	27	20	40.5	20°
63		1/4	25	18	47.5	20°
80		3/8	30	22	60.5	20°
100		1/2	31	22	71	20°

* Install plug bolts, which are included, in any unused mounting holes.

D-□
-X□
Technical
Data

CG5-S Series

Dimensions

Axial foot type (L): C□G5L^NA□S^RV

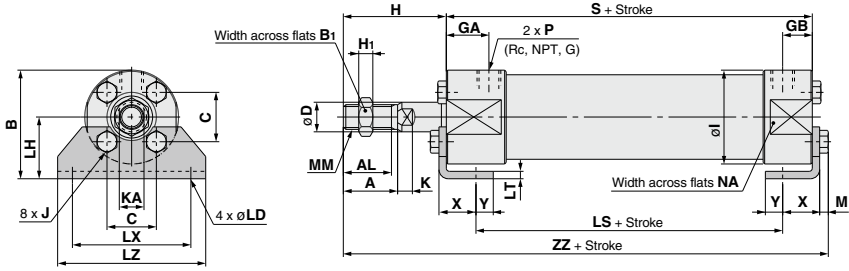

Bore size (mm)	Stroke range	Dimensions (mm)																						
		A	AL	B ₁	B	C	D	GA	GB	H	H ₁	I	J	K	KA	LD	LH	LS	LT	LX	LZ	M	MM	NA
20	Standard	18	15.5	13	37.5	16.5	8	18	12	35	5	31	M4 x 0.7	5	6	6	22	59	3	40	50	3	M8 x 1.25	29
25	Up to 1500	22	19.5	17	41.5	18.5	10	18	12	40	6	33	M5 x 0.8	5.5	8	6	25	59	3	44	60	3.5	M10 x 1.25	29
32		22	19.5	17	44	20	12	18	12	40	6	38	M5 x 0.8	5.5	10	7.2	25	59	3	44	60	3.5	M10 x 1.25	35.5
40		30	27	19	53.5	26	16	19	13	50	8	47	M6 x 1.0	6	14	7.2	30	66	3	54	75	4	M14 x 1.5	44
50		35	32	27	69	32	20	21	14	58	11	58	M8 x 1.25	7	18	10	40	74	4	66	90	5.5	M18 x 1.5	55
63		35	32	27	81	38	20	21	14	58	11	72	M10 x 1.5	7	18	12	45	74	4	82	110	7	M18 x 1.5	69
80		40	37	32	99.5	50	25	28	20	71	13	89	M10 x 1.5	10	22	12	55	82	4	100	130	7	M22 x 1.5	80
100		40	37	41	125	60	30	29	20	71	16	110	M12 x 1.75	10	26	14	70	83	6	120	160	8	M26 x 1.5	100

* Foot brackets and plug bolts are installed when shipped from factory.
 Note 1) ø20 and ø25 cylinders with an air cushion: M5 x 0.8
 Note 2) Refer to the basic type (B)/CG5BA□S^R for the dimensions of air cushion needles.

Bore size (mm)	P		S	X	Y	ZZ
	Rc, NPT	G				
20	1/8 (1)	M5 x 0.8	83	15	7	124
25	1/8 (1)	M5 x 0.8	83	15	7	129.5
32	1/8	1/8	85	16	6	131.5
40	1/8	1/8	93	16.5	6.5	150
50	1/4	1/4	109	21.5	11.5	176.5
63	1/4	1/4	109	21.5	11.5	178
80	3/8	3/8	130	28	17	212
100	1/2	1/2	131	30	15	216

Rod side flange type (F): C□G5F^NA□S^RV

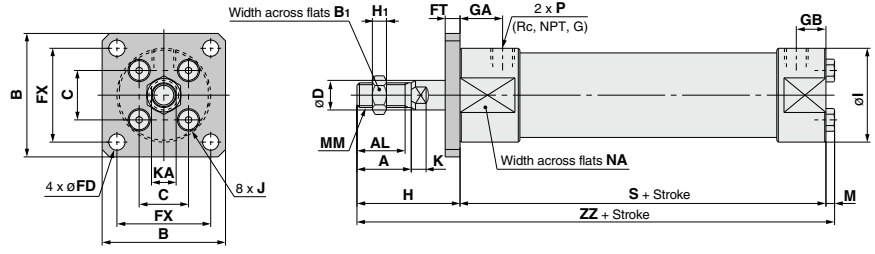

Bore size (mm)	Stroke range	Dimensions (mm)																				P		S	ZZ
		A	AL	B ₁	B	C	D	FX	FD	FT	GA	GB	H	H ₁	I	J	K	KA	M	MM	NA	Rc, NPT	G		
20	Standard	18	15.5	13	50	16.5	8	36	5.5	6	18	12	35	5	31	M4 x 0.7	5	6	3	M8 x 1.25	29	1/8 (1)	M5 x 0.8	83	121
25	Up to 1500	22	19.5	17	50	18.5	10	36	5.5	6	18	12	40	6	33	M5 x 0.8	5.5	8	3.5	M10 x 1.25	29	1/8 (1)	M5 x 0.8	83	126.5
32		22	19.5	17	50	20	12	38	6.6	6	18	12	40	6	38	M5 x 0.8	5.5	10	3.5	M10 x 1.25	35.5	1/8	1/8	85	128.5
40		30	27	19	60	26	16	46	6.6	6	19	13	50	8	47	M6 x 1.0	6	14	4	M14 x 1.5	44	1/8	1/8	93	147
50		35	32	27	75	32	20	58	9	9	21	14	58	11	58	M8 x 1.25	7	18	5.5	M18 x 1.5	55	1/4	1/4	109	172.5
63		35	32	27	90	38	20	70	11	9	21	14	58	11	72	M10 x 1.5	7	18	7	M18 x 1.5	69	1/4	1/4	109	174
80		40	37	32	100	50	25	82	11	9	28	20	71	13	89	M10 x 1.5	10	22	7	M22 x 1.5	80	3/8	3/8	130	208
100		40	37	41	125	60	30	100	14	10	29	20	71	16	110	M12 x 1.75	10	26	8	M26 x 1.5	100	1/2	1/2	131	210

* Flange bracket and plug bolt are installed when shipped from factory.
 Note 1) ø20 and ø25 cylinders with an air cushion: M5 x 0.8
 Note 2) Refer to the basic type (B)/CG5BA□S^R for the dimensions of air cushion needles.



Stainless Steel Cylinder: Standard Type

Double Acting, Double Rod

CG5W-S Series

ø20, ø25, ø32, ø40, ø50, ø63, ø80, ø100

How to Order

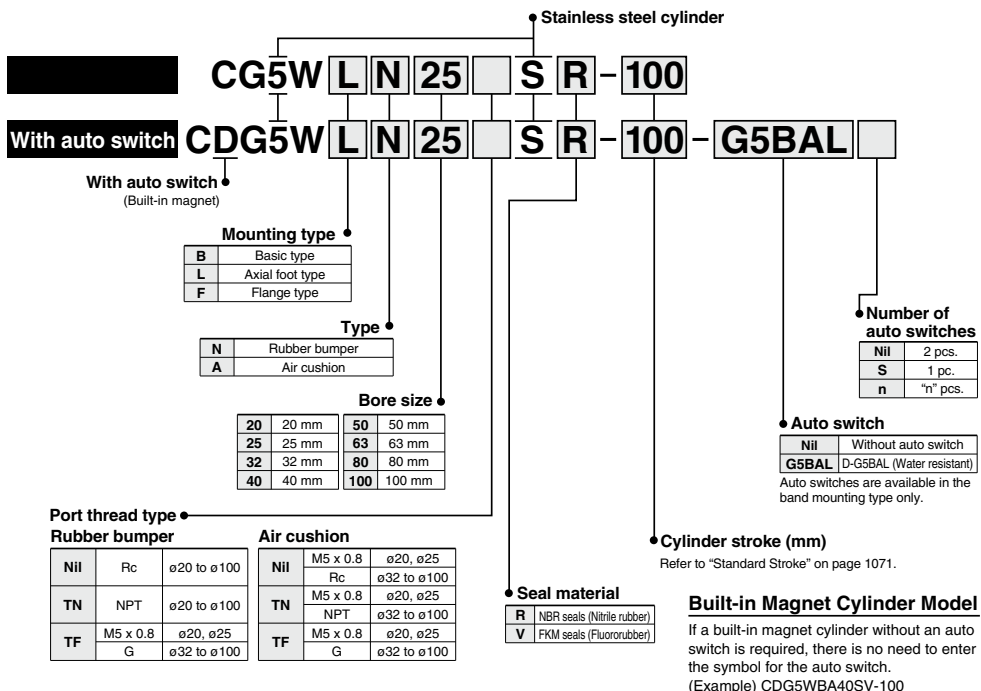

Applicable Auto Switches/Refer to pages 1575 to 1701 for further information on auto switches.

Type	Special function	Electrical entry	Indicator light	Wiring (Output)	Load voltage		Auto switch model	Lead wire length (m)*		Pre-wired connector	Applicable load
					DC	3 (L)		5 (Z)			
Solid state auto switch	Water resistant (2-color indicator)	Grommet	Yes	2-wire	24 V	12 V	G5BA	●	○	○	Relay, PLC

* Lead wire length symbols: 3 m.....L (Example) G5BAL
5 m.....Z (Example) G5BAZ

* Solid state auto switches marked with "○" are produced upon receipt of order.

• For details about auto switches with pre-wired connector, refer to pages 1648 and 1649.

Mounting Bracket Part No.

Mounting bracket	Min. order	Bore size (mm)								Description
		20	25	32	40	50	63	80	100	
Axial foot	2 (Note)	CG-L020SUS	CG-L025SUS	CG-L032SUS	CG-L040SUS	CG-L050SUS	CG-L063SUS	CG-L080SUS	CG-L100SUS	Foot x 2 Bracket mounting bolt x 4
Flange	1	CG-F020SUS	CG-F025SUS	CG-F032SUS	CG-F040SUS	CG-F050SUS	CG-F063SUS	CG-F080SUS	CG-F100SUS	Flange x 1 Bracket mounting bolt x 4

Note) When ordering the foot bracket, order 2 pcs. per cylinder.

Stainless Steel Cylinder: Standard Type **CG5-S Series**

Specifications



Bore size (mm)	20	25	32	40	50	63	80	100
Action	Double acting, Double rod							
Fluid	Air							
Proof pressure	1.5 MPa							
Maximum operating pressure	1.0 MPa							
Minimum operating pressure	0.05 MPa							
Ambient and fluid temperature	Without auto switch: -10 to 70°C With auto switch: -10 to 60°C							
Cushion	Rubber bumper, Air cushion							
Lubrication	Not required (Non-lube)							
Piston speed	50 to 1000 mm/s						50 to 700 mm/s	
Stroke length tolerance	Up to 1000 st + 1.4 ₀ mm, Up to 1500 st + 1.8 ₀ mm							
Mounting type	Basic type, Axial foot type, Flange type							

CJ5
CG5

HY □

Water
Resistant

Symbol

Rubber bumper

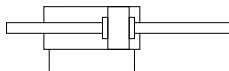

Air cushion

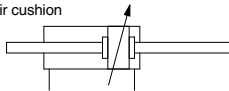

Standard Stroke

(mm)

Bore size	Standard stroke ^{Note 1)}	Maximum manufacturable stroke ^{Note 2)}
20	25, 50, 75, 100, 125, 150, 200	201 to 1500
25	25, 50, 75, 100, 125, 150, 200, 250, 300	301 to 1500
32		
40		
50		
63		
80		
100		

Note 1) Other intermediate strokes can be manufactured upon receipt of order. Manufacture of intermediate strokes in 1 mm increments is possible. (Spacers are not used.)

Note 2) The maximum manufacturable stroke shows the long stroke.

Note 3) Applicable strokes should be confirmed according to the usage. For details, refer to "Air Cylinders Model Selection" on front matter pages. In addition, the products that exceed the standard stroke might not be able to fulfill the specifications due to the deflection etc.

Accessory

/For details, refer to page 1076.

●...Supplied with the product. ○...Please order separately.

Mounting		Basic type	Axial foot type	Flange type
Standard equipment	Rod end nut	●	●	●
Option	Single knuckle joint	○	○	○
	Double knuckle joint (With pin & retaining ring)	○	○	○

Weight

(kg)

Bore size (mm)		20	25	32	40	50	63	80	100
Basic weight	Basic type	0.39	0.48	0.68	1.18	2.15	3.24	6.03	9.48
	Axial foot type	0.54	0.65	0.86	1.40	2.55	3.78	6.80	10.93
	Flange type	0.49	0.57	0.77	1.32	2.47	3.71	6.62	10.52
Single knuckle joint		0.04	0.07	0.07	0.11	0.22	0.22	0.53	0.78
Double knuckle joint (with pin)		0.05	0.09	0.09	0.18	0.33	0.33	0.73	1.07
Additional weight per each 50 mm of stroke		0.06	0.08	0.14	0.18	0.27	0.33	0.50	0.73
Additional weight with air cushion		0.02	0.02	0.02	0.02	0.05	0.10	0.22	0.24

Calculation: (Example) **CG5WLA 20SR-100**
(Foot type ø20, 100 stroke)

- Basic weight 0.54 kg (Foot type ø20)
- Additional stroke weight 0.06 kg/50 ST
- Air cylinder stroke 100 ST
- Additional air cushion weight 0.02 kg
0.54 + 0.06 x 100/50 + 0.02 = 0.68 kg

D-□

-X□

Technical
Data

CG5W-S Series

Construction

With rubber bumper

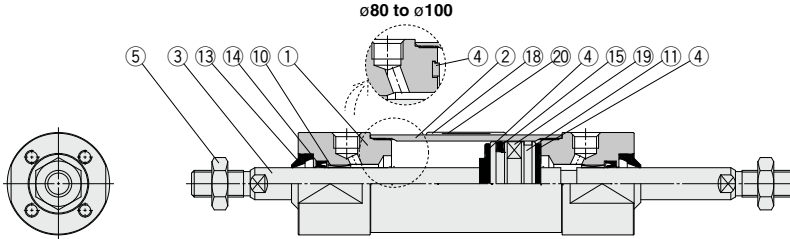

With air cushion

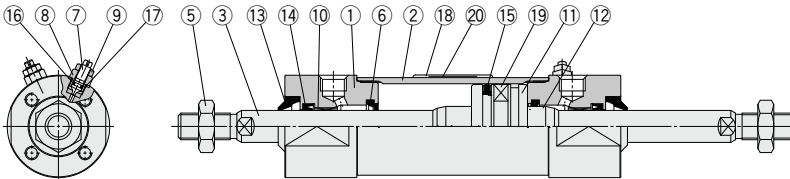

Component Parts

No.	Description	Material	Note
1	Rod cover	Stainless steel	
2	Cylinder tube	Stainless steel	
3	Piston rod	Stainless steel	Hard chrome plated
4	Bumper	Urethane	
5	Rod end nut	Stainless steel	
6	Cushion seal	Urethane	
7	Cushion valve	Stainless steel	
8	Valve retainer	Stainless steel	
9	Lock nut	Stainless steel	
10	Bushing	Bearing alloy	
11	Piston	Aluminum alloy	
12	Cushion ring	Aluminum alloy	

Note 1) Component part material and surface treatment other than listed above are the same as the standard type of the CG1 series.

Note 2) For cylinders with an auto switch, the piston is fixed with a magnet.

No.	Description	Material	
		CG5□□SR	CG5□□SV
13	Water resistant scraper	NBR	FKM
14	Rod seal		
15	Piston seal		
16	Valve seal		
17	Valve retainer gasket		
18	Label protector	PET	
19	Magnet	—	
20	Label	—	

Replacement Parts/Seal Kit

Bore size (mm)	Rubber bumper		Air cushion	
	CG5W□□SR	CG5W□□SV	CG5W□A□SR	CG5W□A□SV
20	CG5WN20SR-PS	CG5WN20SV-PS	CG5WA20SR-PS	CG5WA20SV-PS
25	CG5WN25SR-PS	CG5WN25SV-PS	CG5WA25SR-PS	CG5WA25SV-PS
32	CG5WN32SR-PS	CG5WN32SV-PS	CG5WA32SR-PS	CG5WA32SV-PS
40	CG5WN40SR-PS	CG5WN40SV-PS	CG5WA40SR-PS	CG5WA40SV-PS
Contents	14 (two), 15 (one) + Grease pack: GR-R-010		14 (two), 15 (one), 16 (two), 17 (two), + Grease pack: GR-R-010	

* As sizes $\phi 50$ and larger cannot be disassembled, the seal cannot be replaced. (Refer to page 1080 for details.)

* Seal kit includes a grease pack (10 g).

Order with the following part number when only the grease pack is needed.

Grease pack for stainless steel cylinders/Part no.: GR-R-010 (10 g)

Stainless Steel Cylinder: Standard Type CG5W-S Series

Dimensions

Basic type (B): C□G5WBN□S_V^R : With rubber bumper

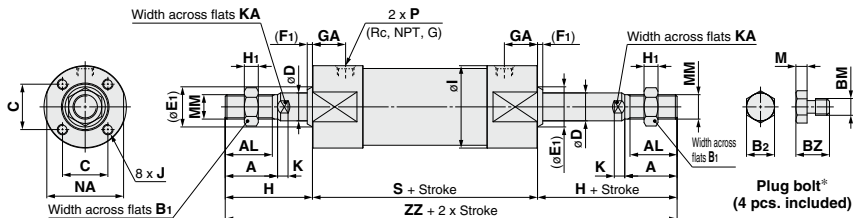

CJ5
CG5

HY□

Water
Resistant

Bore size (mm)	Stroke range (mm)	Standard	A	AL	B ₁	B ₂	BM	BZ	C	D	E ₁	F ₁	GA	H	H ₁	I	J	K	KA	M	MM	NA	P			S	ZZ
																							Rc, NPT	G	G		
20	Up to 1500	18	15.5	13	7	M4 x 0.7	9	16.5	8	15	3	18	35	5	31	M4 x 0.7 depth 7	5	6	3	M8 x 1.25	29	1/8	M5 x 0.8	89	159		
25		22	19.5	17	8	M5 x 0.8	9.5	18.5	10	17	3	18	40	6	33	M5 x 0.8 depth 8	5.5	8	3.5	M10 x 1.25	29	1/8	M5 x 0.8	89	169		
32		22	19.5	17	8	M5 x 0.8	9.5	20	12	19	3	18	40	6	38	M5 x 0.8 depth 8	5.5	10	3.5	M10 x 1.25	35.5	1/8	1/8	91	171		
40		30	27	19	10	M6 x 1.0	12	26	16	23	3	19	50	8	47	M6 x 1.0 depth 12	6	14	4	M14 x 1.5	44	1/8	1/8	99	199		
50		35	32	27	13	M8 x 1.25	15.5	32	20	28	3	21	58	11	58	M8 x 1.25 depth 16	7	18	5.5	M18 x 1.5	55	1/4	1/4	116	232		
63		35	32	27	17	M10 x 1.5	19	38	20	28	3	21	58	11	72	M10 x 1.5 depth 16	7	18	7	M18 x 1.5	69	1/4	1/4	116	232		
80		40	37	32	17	M10 x 1.5	19	50	25	33	3	28	71	13	89	M10 x 1.5 depth 22	10	22	7	M22 x 1.5	80	3/8	3/8	138	280		
100		40	37	41	19	M12 x 1.75	24	60	30	38	3	29	71	16	110	M12 x 1.75 depth 23	10	26	8	M26 x 1.5	100	1/2	1/2	140	282		

* Install plug bolts, which are included, in any unused mounting holes.

Basic type (B): C□G5WBA□S_V^R : With air cushion

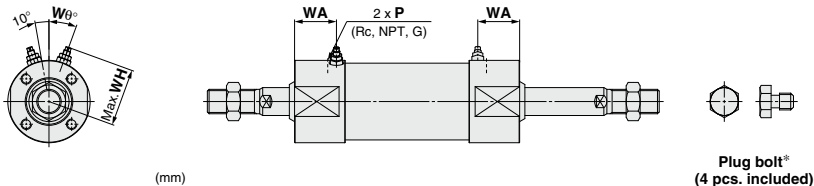

Bore size (mm)	Stroke range (mm)	Standard	P		
			Rc, NPT, G	WA	WH
20	Up to 1500	M5 x 0.8	22	23	30°
25			22	25	30°
32		1/8	22	28.5	25°
40		1/8	24	33	20°
50		1/4	27	40.5	20°
63		1/4	25	47.5	20°
80		3/8	30	60.5	20°
100		1/2	31	71	20°

* Install plug bolts, which are included, in any unused mounting holes.

D-□

-X□

Technical
Data

CG5W-S Series

Dimensions

Axial foot type (L): C□G5WL_A□S^R_V

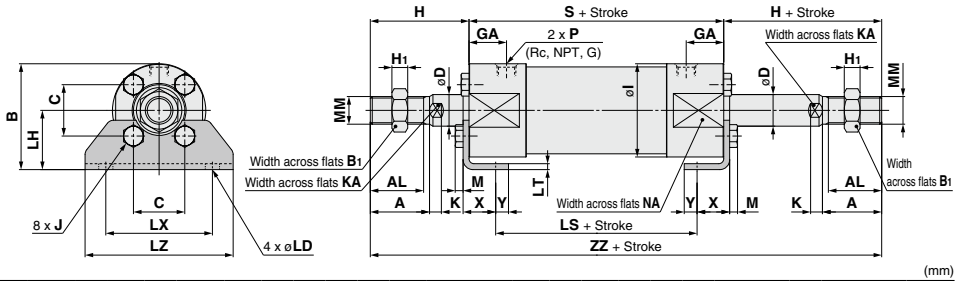

Bore size (mm)	Stroke range (mm) Standard	A	AL	B ₁	B	C	D	GA	H	H ₁	I	J	K	KA	LD	LH	LS	LT	LX	LZ	M	MM	NA
		20	18	15.5	13	37.5	16.5	8	18	35	5	31	M4 x 0.7	5	6	6	22	65	3	40	50	3	M8 x 1.25
25	22	19.5	17	41.5	18.5	10	18	40	6	33	M5 x 0.8	5.5	8	6	25	65	3	44	60	3.5	M10 x 1.25	29	
32	22	19.5	17	44	20	12	18	40	6	38	M5 x 0.8	5.5	10	7.2	25	65	3	44	60	3.5	M10 x 1.25	35.5	
40	30	27	19	53.5	26	16	19	50	8	47	M6 x 1.0	6	14	7.2	30	72	3	54	75	4	M14 x 1.5	44	
50	35	32	27	69	32	20	21	58	11	58	M8 x 1.25	7	18	10	40	81	4	66	90	5.5	M18 x 1.5	55	
63	35	32	27	81	38	20	21	58	11	72	M10 x 1.5	7	18	12	45	81	4	82	110	7	M18 x 1.5	69	
80	40	37	32	99.5	50	25	28	71	13	89	M10 x 1.5	10	22	12	55	90	4	100	130	7	M22 x 1.5	80	
100	40	37	41	125	60	30	29	71	16	110	M12 x 1.75	10	26	14	70	92	6	120	160	8	M26 x 1.5	100	

* Foot brackets and plug bolts are installed when shipped from factory.

Note 1) ø20 and ø25 cylinders with an air cushion: M5 x 0.8

Note 2) Refer to the basic type (B)/CG5WBACIS* for the dimensions of air cushion needles.

Bore size (mm)	P		S	X	Y	ZZ
	Rc, NPT	G				
20	1/8 ⁽¹⁾	M5 x 0.8	89	15	7	159
25	1/8 ⁽¹⁾	M5 x 0.8	89	15	7	169
32	1/8	1/8	91	16	6	171
40	1/8	1/8	99	16.5	6.5	199
50	1/4	1/4	116	21.5	11.5	232
63	1/4	1/4	116	21.5	11.5	232
80	3/8	3/8	138	28	17	280
100	1/2	1/2	140	30	15	282

Rod side flange type (F): C□G5WF_A□S^R_V

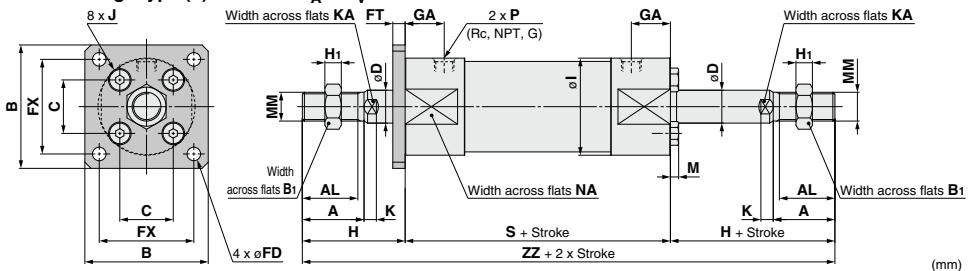

Bore size (mm)	Stroke range (mm) Standard	A	AL	B ₁	B	C	D	FX	FD	FT	GA	H	H ₁	I	J	K	KA	M	MM	NA	P		S	ZZ
		Rc, NPT	G																					
20	18	15.5	13	50	16.5	8	36	5.5	6	18	35	5	31	M4 x 0.7	5	6	3	M8 x 1.25	29	1/8 ⁽¹⁾	M5 x 0.8	89	159	
25	22	19.5	17	50	18.5	10	36	5.5	6	18	40	6	33	M5 x 0.8	5.5	8	3.5	M10 x 1.25	29	1/8 ⁽¹⁾	M5 x 0.8	89	169	
32	22	19.5	17	50	20	12	38	6.6	6	18	40	6	38	M5 x 0.8	5.5	10	3.5	M10 x 1.25	35.5	1/8	1/8	91	171	
40	30	27	19	60	26	16	46	6.6	6	19	50	8	47	M6 x 1.0	6	14	4	M14 x 1.5	44	1/8	1/8	99	199	
50	35	32	27	75	32	20	58	9	9	21	58	11	58	M8 x 1.25	7	18	5.5	M18 x 1.5	55	1/4	1/4	116	232	
63	35	32	27	90	38	20	70	11	9	21	58	11	72	M10 x 1.5	7	18	7	M18 x 1.5	69	1/4	1/4	116	232	
80	40	37	32	100	50	25	82	11	9	28	71	13	89	M10 x 1.5	10	22	7	M22 x 1.5	80	3/8	3/8	138	280	
100	40	37	41	125	60	30	100	14	10	29	71	16	110	M12 x 1.75	10	26	8	M26 x 1.5	100	1/2	1/2	140	282	

* Flange bracket and plug bolt are installed when shipped from factory.

Note 1) ø20 and ø25 cylinders with an air cushion: M5 x 0.8

Note 2) Refer to the basic type (B)/CG5WBACIS* for the dimensions of air cushion needles.

CG5-S series Accessory Dimensions

Single Knuckle Joint

Material: Stainless steel 304

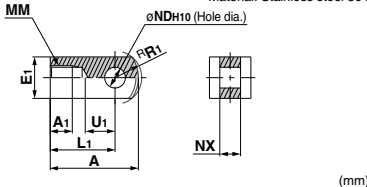

Part no.	Applicable bore size (mm)	A	A1	E1	L1	MM	NDH10	NX	R1	U1
I-G02SUS	20	34	8.5	16	25	M8 x 1.25	8 ^{+0.058} ₀	8 ^{-0.2} _{-0.4}	10.3	11.5
I-G03SUS	25, 32	41	10.5	20	30	M10 x 1.25	10 ^{+0.058} ₀	10 ^{-0.2} _{-0.4}	12.8	14
I-G04SUS	40	42	14	22	30	M14 x 1.5	10 ^{+0.058} ₀	18 ^{-0.3} _{-0.5}	12	14
I-G05SUS	50, 63	56	18	28	40	M18 x 1.5	14 ^{+0.070} ₀	22 ^{-0.3} _{-0.5}	16	20
I-G08SUS	80	71	21	38	50	M22 x 1.5	18 ^{+0.070} ₀	28 ^{-0.3} _{-0.5}	21	27
I-G10SUS	100	79	21	45	55	M26 x 1.5	22 ^{+0.084} ₀	32 ^{-0.3} _{-0.5}	24	31

Knuckle Joint Pin

Material: Stainless steel 440 (Pin)
Stainless steel 304 (Retaining ring)

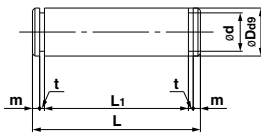

Part no.	Applicable bore size (mm)	dD9	d	L	L1	m	t	Applicable retaining ring
IY-G02SUS	20	8 ^{-0.040} _{-0.078}	7.6	21	16.2	1.5	0.9	Type C 8 for axis
IY-G03SUS	25, 32	10 ^{-0.040} _{-0.078}	9.6	25.6	20.2	1.55	1.15	Type C 10 for axis
IY-G04SUS	40	10 ^{-0.040} _{-0.078}	9.6	41.6	36.2	1.55	1.15	Type C 10 for axis
IY-G05SUS	50, 63	14 ^{-0.050} _{-0.093}	13.4	50.6	44.2	2.05	1.15	Type C 14 for axis
IY-G08SUS	80	18 ^{-0.060} _{-0.093}	17	64	56.2	2.55	1.35	Type C 18 for axis
IY-G10SUS	100	22 ^{-0.080} _{-0.117}	21	72	64.2	2.55	1.35	Type C 22 for axis

* Retaining rings are included.

Clevis Pin

Material: Stainless steel 440 (Pin)
Stainless steel 304 (Retaining ring)

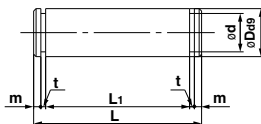

Part no.	Applicable bore size (mm)	dD9	d	L	L1	m	t	Applicable retaining ring
CD-E02SUS	20, 25	ø8 ^{-0.040} _{-0.078}	7.6	27.6	22.8	1.5	0.9	Type C 8 for axis
CD-E03SUS	32, 40	ø10 ^{-0.040} _{-0.078}	9.6	38.4	33	1.55	1.15	Type C 10 for axis
CD-E05SUS	50, 63	ø14 ^{-0.050} _{-0.093}	13.4	59.6	53.2	2.05	1.15	Type C 14 for axis
CD-E08SUS	80, 100	ø22 ^{-0.060} _{-0.117}	21	87.2	79.4	2.55	1.35	Type C 22 for axis

* Retaining rings are included.

Double Knuckle Joint

Material: Stainless steel 440 (Pin)
Stainless steel 304 (Bracket, retaining ring)

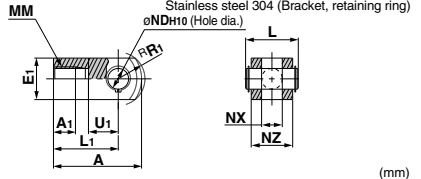

Part no.	Applicable bore size (mm)	A	A1	E1	L	L1	MM	NDH10	NX	NZ	R1	U1	Applicable pin no.
Y-G02SUS	20	34	8.5	16	21	25	M8 x 1.25	8 ^{+0.058} ₀	8 ^{+0.4} _{+0.2}	16	10.3	11.5	IY-G02SUS
Y-G03SUS	25, 32	41	10.5	20	26.6	30	M10 x 1.25	10 ^{+0.058} ₀	10 ^{+0.4} _{+0.2}	20	12.8	14	IY-G03SUS
Y-G04SUS	40	42	16	22	41.6	30	M14 x 1.5	10 ^{+0.058} ₀	18 ^{+0.3} _{+0.5}	36	12	14	IY-G04SUS
Y-G05SUS	50, 63	56	20	25	50.6	40	M18 x 1.5	14 ^{+0.070} ₀	22 ^{+0.3} _{+0.5}	44	16	20	IY-G05SUS
Y-G08SUS	80	71	21	35	64	50	M22 x 1.5	18 ^{+0.070} ₀	28 ^{+0.3} _{+0.5}	56	21	27	IY-G08SUS
Y-G10SUS	100	79	24	40	72	55	M26 x 1.5	22 ^{+0.084} ₀	32 ^{+0.3} _{+0.5}	64	24	31	IY-G10SUS

* Knuckle joint pins and retaining rings are included.

Pivot Bracket

Material: Stainless steel 440 (Pin)
Stainless steel 304 (Bracket, retaining ring)

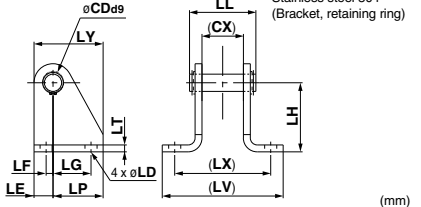

Part no.	Applicable bore size (mm)	CD (Retaining ring)	CX	LD	LE	LF	LG	LH	LL	LP	LV	LX	LY
CG-E020SUS	20, 25	8 ^{-0.040} _{-0.078}	16	7	9	2	14	30	27.6	21	3	56.5	42
CG-E032SUS	32, 40	10 ^{-0.040} _{-0.078}	24	7	11	4	22	40	38.4	29	4	70.5	56
CG-E050SUS	50, 63	14 ^{-0.050} _{-0.093}	40	12	15	5	25	50	59.6	35	6	106.5	84
CG-E080SUS	80, 100	22 ^{-0.060} _{-0.117}	60	14	23	6	40	80	87.2	57	9	144.5	120

* Clevis pins and retaining rings are included.

Rod End Nut

Material: Stainless steel 304

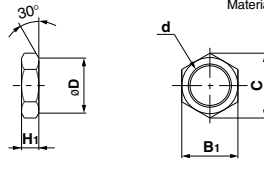

Part no.	Applicable bore size (mm)	B1	C	D	d	H1
NT-02SUS	20	13	(15)	12.5	M8 x 1.25	5
NT-03SUS	25, 32	17	(19.6)	16.5	M10 x 1.25	6
NT-G04SUS	40	19	(21.9)	18	M14 x 1.5	8
NT-05SUS	50, 63	27	(31.2)	26	M18 x 1.5	11
NT-08SUS	80	32	(37.0)	31	M22 x 1.5	13
NT-10SUS	100	41	(47.3)	39	M26 x 1.5	16

CJ5-S/CG5-S Series Auto Switch Mounting

Proper Auto Switch Mounting Position (Detection at stroke end) and Mounting Height

CJ5-S Series D-M9□A(V) D-H7BA

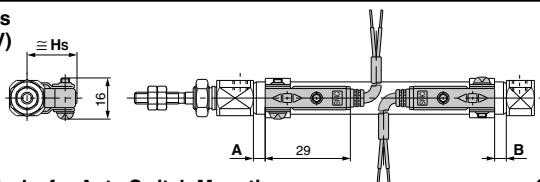

Minimum Stroke for Auto Switch Mounting

Mounting bracket	Basic type, Foot type, Flange type, Clevis type		
Number of auto switches	1	2	2
	(Rod cover side)	(Different sides)	(Same side)
Switch mounting side	Port side	Port side	Port side
Switch type			
Minimum stroke (mm)	10	15	60

Auto Switch Mounting Bracket / Part No.

Auto switch model	Bore size (mm)	
	ø10	ø16
D-M9□A D-M9□AV	BJ6-010S (Note 1)	BJ6-016S (Note 1)
D-H7BA	BJ2-010S	BJ2-016S

* With stainless steel mounting screws.

Note 1) Set part number which includes the auto switch mounting band (BJ2-□□□S) and the holder kit (BJ4-1/Switch bracket; White).

Note 2) For D-M9□A(V), avoid the indicator LED for mounting the switch bracket.

CG5-S Series D-G5BA

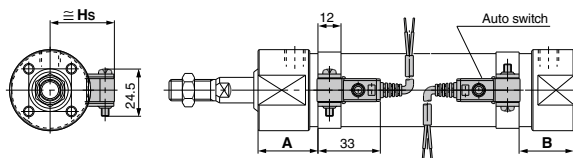

Minimum Stroke for Auto Switch Mounting

Mounting bracket	Basic type, Foot type, Flange type, Clevis type		
Number of auto switches	1	2	2
	(Rod cover side)	(Different sides)	(Same side)
Switch mounting side	Port side	Port side	Port side
Switch type			
Minimum stroke (mm)	10	15	75

Auto Switch Mounting Bracket / Part No.

Auto switch model	Bore size (mm)									
	20	25	32	40	50	63	80	100		
D-G5BA	NBA-088S	NBA-106S	BGS1-032S	BAF-04S	-05S	BAF-06S	BAF-08S	BAF-10S		

* With stainless steel mounting screws.

Operating Range

Auto switch model	Bore size (mm)	
	10	16
D-H7BA	5	5

* Since this is a guideline including hysteresis, not meant to be guaranteed. (Assuming approximately ±30% dispersion) There may be the case to change substantially depending on an ambient environment.

Proper Auto Switch Mounting Position and Its Mounting Height

Applicable bore size (mm)	Auto switch model		
	D-H7BA	A	B
10	0	0	17
16	0.5	0.5	20.5

Note) Adjust the auto switch after confirming the operating condition in the actual setting.

Operating Range

Auto switch model	Bore size (mm)									
	20	25	32	40	50	63	80	100		
D-G5BA	5	5	5.5	6	7	7.5	7.5	8		

* Since this is a guideline including hysteresis, not meant to be guaranteed. (Assuming approximately ±30% dispersion) There may be the case to change substantially depending on an ambient environment.

Proper Auto Switch Mounting Position and Its Mounting Height

Applicable bore size (mm)	Auto switch model		
	D-G5BA	A	B
20	31.5	26	26
25	31.5	28.5	28.5
32	32.5	33	33
40	37	36.5	36.5
50	45.5	42	42
63	45.5	48.5	48.5
80	56	57.5	57.5
100	57	68	68

Note) Adjust the auto switch after confirming the operating condition in the actual setting.

CJ5
CG5

HY□

Water
Resistant

D-□

-X□

Technical
Data

Technical Data: Chemical Resistance Table

⊙ : No influence or almost no influence
 ○ : Some influence, but operational depending on conditions
 △ : Avoid use if possible
 × : Substantial influence, not suitable for use
 — : Not tested

Chemical Resistance Table

Parts		Body		Seal		Water resistant auto switch	
Material		Stainless steel	Aluminum*	Nitrile rubber	Fluororubber	Resin casing	Lead wire
Chemical (Concentration weight %, Temperature °C)	Symbol	Stainless steel 304	Al	NBR (-10 to 60°C)	FKM (-40 to 150°C)	PBT (-10 to 60°C)	PVC (-10 to 60°C)
		Inorganic salt	1 Hydrochloric acid (20%, Room temperature)	×	×	○	⊙
	2 Chromic acid (25%, 70°C)	○	×	×	⊙	⊙	○
	3 Boric acid	○	×	⊙	⊙	⊙	○
	4 Sulfuric acid (30%, Room temperature)	×	×	⊙	⊙	⊙	○
	5 Phosphoric acid (50%, Room temperature)	○	×	⊙	⊙	⊙	○
	6 Ammonium hydroxide (28%)	○	○	○	×	⊙	○
Inorganic alkali	7 Sodium hydroxide (30%, Room temperature)	⊙	×	⊙	△	⊙	×
	8 Calcium hydroxide	△	×	⊙	⊙	⊙	⊙
	9 Magnesium hydroxide	○	○	⊙	⊙	⊙	⊙
Organic solvent	10 Acetylene	⊙	△	⊙	⊙	⊙	⊙
	11 Formic acid (25%, Room temperature)	○	△	×	△	△	△
	12 Citric acid	△	×	⊙	⊙	△	○
	13 Acetic acid (10%, Room temperature)	⊙	△	△	○	⊙	○
	14 Lactic acid (5%, 20°C)	○	×	⊙	⊙	⊙	○
Others (oil, gas, etc.)	15 Linseed oil	⊙	○	⊙	⊙	△	△
	16 Potassium chloride	○	△	⊙	⊙	⊙	⊙
	17 Calcium chloride	○	⊙	⊙	⊙	⊙	⊙
	18 Mineral oil	⊙	⊙	⊙	⊙	⊙	△
	19 Sodium hypochlorite (2%, Room temperature)	○	×	×	⊙	⊙	△
	20 Sodium chloride	○	—	⊙	⊙	⊙	⊙
	21 Carbon dioxide	⊙	⊙	⊙	⊙	⊙	⊙
	22 Natural gas	⊙	⊙	⊙	⊙	⊙	⊙
	23 Boric acid	○	×	⊙	⊙	⊙	○

* Unless noted otherwise, the solution concentration is in a saturated state.

* Chemical resistance is a guide that applies only to the stainless steel cylinder parts, and does not guarantee the performance of air cylinders (auto switches).
 Be sure to perform a verification test before operating.

*) Reference data



CJ5-S/CG5-S Series Stainless Steel Cylinder Specific Product Precautions 1

Be sure to read this before handling the products.

Refer to back page 50 for Safety Instructions and pages 3 to 12 for Actuator and Auto Switch Precautions.

Caution on Design

Warning

- Note the weight of the stainless steel products.**
Since the weight of stainless steel cylinders is approximately 1.5 to 3 times heavier than the standard products (with aluminum body), be careful when calculating weight estimates. Also, when mounting the cylinder on equipment where vibration is expected, avoid using single side brackets such as the flange type, and use double side brackets such as the foot type instead.

Caution

- Adjust the speed control for the environment in which it will be used.**
Speed adjustment may be changed depending on the environment.
- Dust may accumulate on this product's mounting screws and brackets in some operating conditions.**
Measures must be applied depending on the operating conditions when mounting.

Selection

Warning

- Generally, use nitrile rubber (NBR) seals with liquids that do not contain chlorine and sulfur, and use fluoro rubber (FKM) seals with liquids that contain chlorine and sulfur.**
However, depending on the type and the brand of liquid (such as cleaning solvent) that splashes on the cylinder, the operating life of seals may be reduced dramatically. In cases where special additives are used, or where liquid caused trouble with the current nitrile or fluoro rubber seals in the past, request an investigation or set up a test period for the use of the seals.
- Even the fluoro rubber specification may not be applicable depending on the type of chemicals and the operating temperature. Therefore, be sure to verify the seal's applicability before use.**

Mounting

Warning

- Do not rotate the cover.**
If a cover is rotated when installing a cylinder or screwing a fitting into the port, it is likely to damage the junction part with cover.
- When using pins, apply grease, etc., in order to prevent them from degrading of shape and rusting.**

Operating Precautions

Warning

- For details about operating precautions, refer to page 152 for the CJ2 series (CJ5-S) and page 362-1 for the CG1 series (CG5-S).

Caution

- If cleaning the rotating part, grease may leak out, which shortens product service life. Thus, cleaning must be as infrequent as possible.
- If excess water gets into mounting holes, unwanted bacteria may reproduce. Plug them with plug bolts or external covers to avoid this.

Operating Environment

Warning

- Fully consider the compatibility of stainless steel.**
The corrosion resistance of stainless steel is not effective against all media and corrosive environments. Corrosion proceeds rapidly with strong hydrochloric acid, hydrofluoric acid, and high temperature ammonium gas, etc. Therefore its compatibility to the environment must be considered carefully.
- Do not operate cylinders with auto switches in environments where oil and chemicals are used.**
Please contact SMC when operating in environments with coolants, cleaning solvents, various oils or chemicals, as it may cause adverse effects (faulty insulation, malfunction due to swelling of the potting resin, and hardening of lead wires, etc) to auto switches even in a short period of time. Even with the fluoro rubber seal specification, the auto switch related parts (switch body, mounting bracket, and built-in magnet) are identical to the standard specifications. Therefore, consult with SMC regarding the cylinder's compatibility (such as chemical resistance) with an environment (chemicals, etc.) before operating.
- Do not immerse the cylinder in water or chemicals.**
When the cylinder is operated in a condition with water pressure, the fluid leaks into the cylinder in the early stages. In the worst case, the fluid may back flow inside the piping and damage the solenoid valve.

Caution

- Avoid installing and using a cylinder inside a food zone.**
<Not installable>
Food zone An environment where food which will be sold as merchandize, directly touches the cylinder's components.

<Installable>
Splash zone An environment where food which will not be sold as merchandize, directly touches the cylinder's components.

Non-food zone An environment where there is no contact with food.

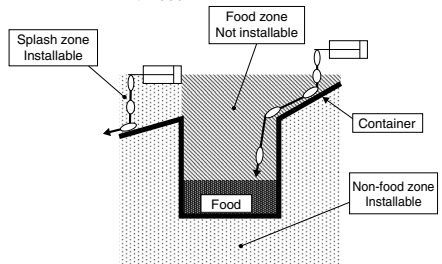

- When cleaning solvent or chemicals splashes on a cylinder, the service life may be extremely shortened. Please contact SMC for details.
- When cleaning cylinders with steam, do it as quickly as possible, keeping the cylinder's temperature range in mind.
- When cleaning cylinders with a brush, etc., do not apply excessive force to the weaker parts, such as auto switch lead wire, etc.

CJ5
CG5

HY □

Water
Resistant

D- □

-X □

Technical
Data



CJ5-S/CG5-S Series Stainless Steel Cylinder Specific Product Precautions 2

Be sure to read this before handling the products.

Refer to back page 50 for Safety Instructions and pages 3 to 12 for Actuator and Auto Switch Precautions.

Maintenance

Warning

1. If this cylinder is lubricated, it may cause malfunctions.

If grease other than designated is used, it may also cause malfunctions.

- Order with the following part number when only the grease for maintenance is needed.

Grease pack part number for stainless steel cylinders

Grease for food processing machines: GR-R-010 (10 g)

2. Do not wipe grease attached to the rotating part of the air cylinder.

If grease attached to the rotating part is forcibly wiped off, it may cause malfunctions.

If the cylinder is operated for a long period of time, the rotating part may become black. In such cases, wipe the grease attached to the rotating part and reapply fresh grease to enable the cylinder to operate for a long period of time.

(Wipe the grease with water. Using alcohol or solvents may damage seals.)

Precautions for the CG5-S series

Warning

1. Only people who have sufficient knowledge and experience are allowed to replace seals.

The person who disassembles and reassembles the cylinder is responsible for the safety of the product. Repeatedly disassembling and reassembling the product may cause wearing or deformation of the screws as well as a decline in screw tightening strength. When reassembling the product, be sure to check the cover and tubing screws for wear, deformities, or any other abnormalities. Operating the product with damaged screws may result in the cover or tubing coming off during operation, which could lead to a serious accident. Caution must be taken to avoid such incidents.

Caution

1. Sealant* is used on the threads of the connecting sections of the cover and the cylinder tube for airtight construction. When disassembling the cylinder, the old sealant must be completely removed, and new sealant must be applied before re-assembling.

* Loctite® 542 (medium strength) or equivalent

2. ø50 or larger bore size cylinders cannot be disassembled.

When disassembling cylinders with bore sizes of ø20 through ø40, grip the double flat part of either the head cover or the rod cover with a vise and loosen the other side with a wrench or a monkey wrench, etc., and then remove the cover. When re-tightening, tighten approximately 2 degrees more than the original position. (Cylinders with ø50 or larger bore sizes are tightened with a large tightening torque and cannot be disassembled. Please contact SMC when disassembly is required.)

3. When replacing seals, take care not to hurt your hand or finger on the corners of parts.