

Description

Single pole, magnetic simulator switch with extremely low trip current and precise trip behavior. Available with threadneck mounting or flange mounting. Actuation is via a push-pull mechanism. Push button marking for simulation of various current ratings is optionally available as marking insert (plug-in, exchangeable) or marking label. Terminal designs include blade terminals, screw terminals or wire wrap terminals. Optionally available with auxiliary contact.

US patent number: US 7,038,562 B1

Typical application

Flight Simulators

Ordering information

Type No.

9510 switch with magnetic instantaneous trip for flight simulators

Mounting method and style

G threadneck mounting with standard push button

Threadneck design

1 M12x1x6.3

2 7/16-32UNx6.3

Number of poles

1 single pole

Accessories for threadneck

2 hex nut M12x1, aluminium, serrated lock washer $\phi 12.1/\phi 17.2$, fitted

3 hex nut 7/16-32UN, aluminium, serrated lock washer 11.3/14.9, fitted

Terminal configuration

J screw terminals with inch thread

1 6-32UNC-2B, silver plated bent 45° inwards

3 6-32UNC-2B, silver plated, with socket, bent 45° inwards

P blade terminals

1 A6.3x0.8 DIN 46244, silver plated

W wire wrap terminal

4 pin size 1.2x1.2 EN 60352-1, gold plated, with socket

Rated voltage

F0 DC 24 V

F1 DC 28 V

Accessories (terminal screws)

B Phillips screw 6-32UNC-2Ax4.8 fitted (MS 51957-25)

Z without accessories

Accessories (terminal washers)

0 without accessories

2 3.6 split washer fitted (MS 35338-136)

Internal circuit

R2 with logic diode

Colour of the push button

S black

A green, for marking insert

B black, for marking insert

0 without marking

1 hot-stamped marking, can be read when locating pin is above

9 without marking insert

Auxiliary contact versions:

blank: no auxiliary contact (standard)

S1 with auxiliary contact (female contact for male contacts to EN 3155-016 M2018)

S5 with polarized auxiliary contact (female contact for male contacts to EN 3155-016 M2018)

Current ratings

0.5...150 A

9510 - G 2 1 3 - J 1 F1 - B 0 R2 S 1 - S1 - 5 A ordering example

Please be informed that we have minimum ordering quantities to be observed.



9510-...



9510-... with auxiliary contact

Technical data

Voltage rating (Other voltage ratings upon request)	DC 24 V	DC 28 V
Trip current	< 170 mA	< 200 mA
Trip time	< 25 ms	< 25 ms
Min. switching voltage at +23 °C/+73.4 °F at +60 °C/+140 °F	DC 22 V DC 24 V	DC 25 V DC 28 V
Internal resistance	approx. 153 Ω	approx. 153 Ω
Rated voltage auxiliary circuit	DC 28 V / AC 5 V (400 Hz)	
Rated load, auxiliary circuit at DC 28 V at DC 28 V at AC 5 V (400 Hz) at DC 5 V	0,5 A resistive 0,2 A lamp load 0,24 A lamp load 0,005 A minimum load	
Typical life	without auxiliary contact: 10 000 operations at rated voltage with auxiliary contact: 5 000 operations at rated voltage	
Temperature range	-30 °C ...60 °C (-22...+140 °F)	
Insulation resistance	> 100 MΩ (DC 500 V)	
Dielectric strength (leakage current < 1mA)	AC 1500 V main terminal to main terminal, main circuit open	
	AC 800 V terminal to terminal, auxiliary circuit open	
	AC 1500 V main circuit to main circuit	
Degree of protection (IEC 60529)	operating area IP40 terminal area IP00	
Vibration (sinusoidal)	x axis, y axis: 3 g (57-500 Hz), +0.23 mm (10-57 Hz) to DIN IEC 60068-2-6, test Fc 10 cycles/frequency axis z axis: 2 g (57-500 Hz), +0.23 mm (10-57 Hz) to DIN IEC 60068-2-6, test Fc 10 cycles/frequency axis	
Shock	5 g (11 ms), to DIN IEC 60068-2-27, test Ea	
Humidity	240 hours at 95 % RH, 40 °C to DIN IEC 60068-2-3, test Ca	
Mass	23 g without accessories 26 g with accessories approx. 27 g with auxiliary contact, without accessories approx. 30 g with auxiliary contact, with accessories	

Dimensions

9510-G...-J1...-B2...

tightening torque max. 3.5 Nm

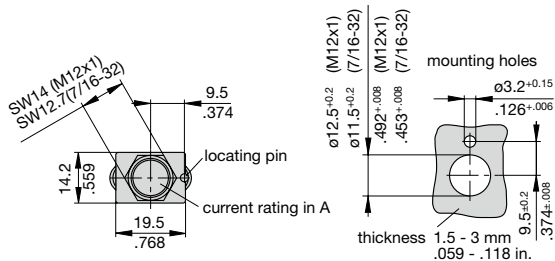
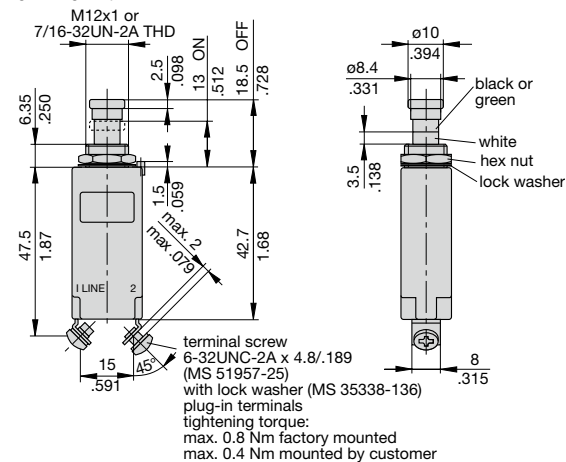

9510-G...-J1...-B0...-S1...

9510 with auxiliary contact

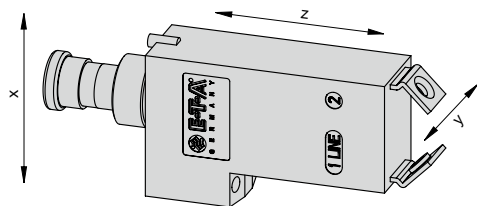
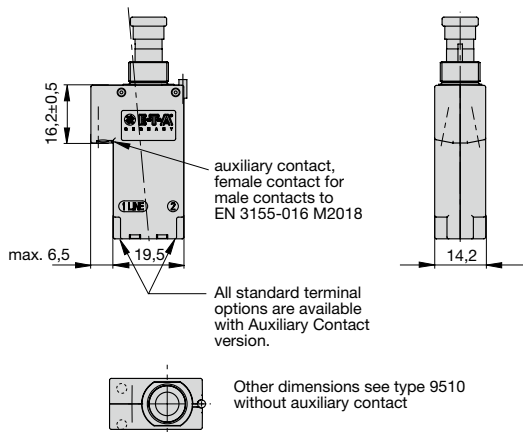

Other main terminal designs

-P1...

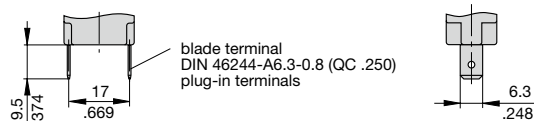

-J3...

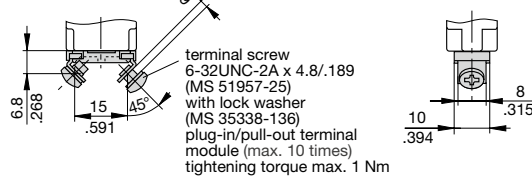

-W4...

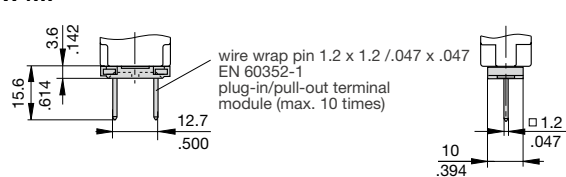

Internal connection diagram

internal circuit R 2

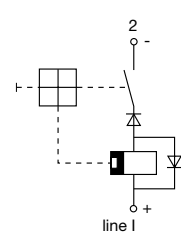

with auxiliary contact

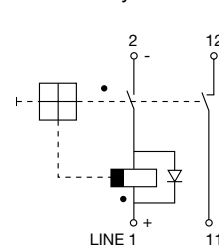

with polarized auxiliary contact

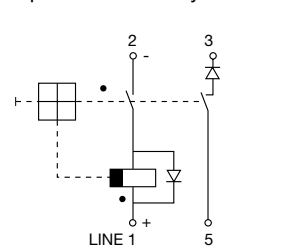

This is a metric design and millimeter dimensions take precedence ($\frac{\text{mm}}{\text{inch}}$)

Accessories

Label (black) for push/pull button (S0)

Rated current (A)	Part number
0.5	Y 307 082 01
1/2	Y 307 082 02
1	Y 307 082 03
1.5	Y 307 082 04
1 1/2	Y 307 082 05
2	Y 307 082 06
2.5	Y 307 082 29
2 1/2	Y 307 082 30
3	Y 307 082 07
3 1/2	Y 307 082 31
4	Y 307 082 35
5	Y 307 082 08
5.5	Y 307 082 33
6	Y 307 082 17
7.5	Y 307 082 09
7 1/2	Y 307 082 10
10	Y 307 082 11
15	Y 307 082 12
17	Y 307 082 34
20	Y 307 082 13
25	Y 307 082 14
30	Y 307 082 15
35	Y 307 082 16
40	Y 307 082 18
50	Y 307 082 19
60	Y 307 082 20
70	Y 307 082 21
75	Y 307 082 22
80	Y 307 082 23
90	Y 307 082 24
100	Y 307 082 25
120	Y 307 082 26
125	Y 307 082 27
150	Y 307 082 28
R	Y 307 082 32

Plug-in screw terminal,

- bent at 45° inwards (2 pcs needed per unit)
- Y 307 187 02** terminal silver plated
- Y 304 508 02** Phillips screw 6-32 UNC-2Ax4.8 (MS 51957-25)
- Y 304 509 01** split washer (MS 35338-136)

Plug-in blade terminal (2 pcs needed per unit)

- Y 307 202 02** P10 terminal silver plated

Plug-in/pull-out screw terminals with socket,

- bent at 45° inwards
- X 222 173 11** terminals silver plated

Plug-in/pull-out wire wrap terminals with socket

- X 222 174 12** terminals gold plated

Splash cover/hex nut assembly with O ring (IP66 and IP67)
 (approved to VG 95345, part 23)
X 200 801 03 matt black finish nut M12x1x1.8, black cover
X 200 801 08 nickel plated nut M12x1x1.8, transparent cover
X 200 801 09 matt black finish nut 7/16-32x1x1.8, black cover
X 200 801 10 matt black finish nut 7/16-32x1x1.8, transparent cover
X 200 801 12 with blackened nut and transparent cover

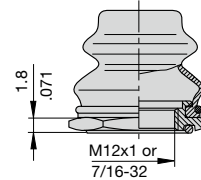

Actuator extension (black) to be fitted on the push button
 (approved to VG 95345, T23)
X 200 803 01

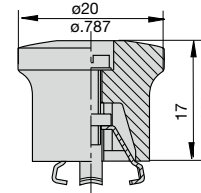

Identification collar to be snapped on the push button

- Y 307 004 01** black
- Y 307 004 02** white
- Y 307 004 03** red
- Y 307 004 04** green
- Y 307 004 05** blue

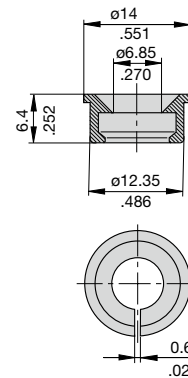

Lock out ring to block the push button in OFF position

- Y 307 005 01** red
- Y 307 005 02** black

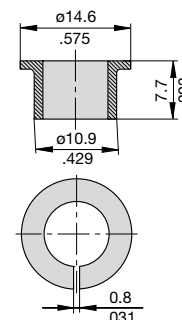

This is a metric design and millimeter dimensions take precedence (mm/inch)

Accessories

Hex nut M12x1
Y 300 116 04

Hex nut 7/16-32
Y 304 506 03

Lock washer Ø12 / Ø15
Y 300 118 03

Serrated lock washer Ø12.1 / Ø17.2
Y 302 911 01

Toothed washer Ø11.3 / Ø14.9 (MS 35333-141)
Y 304 507 01

**Front plate with mounting thread 6-32UNC-2B
for threadneck 7/16-32UN**
Y 301 516 21

Threaded sleeve
Y 307 281 04

Extracting tool of marking insert
Y 307 301 01

Marking inserts (push button configuration A or B)

hot stamped		
current rating (A)	black	green
without	Y 307 280 01	Y 307 280 02
1/4	X 222 175 35	X 222 176 35
0.5	X 222 175 01	X 222 176 01
1/2	X 222 175 02	X 222 176 02
0.75	X 222 175 41	X 222 176 41
3/4	X 222 175 36	X 222 176 36
1	X 222 175 03	X 222 176 03
1.5	X 222 175 04	X 222 176 04
1 1/2	X 222 175 05	X 222 176 05
2	X 222 175 06	X 222 176 06
2.5	X 222 175 29	X 222 176 29
2 1/2	X 222 175 30	X 222 176 30
3	X 222 175 07	X 222 176 07
3.5	X 222 175 33	X 222 176 33
3 1/2	X 222 175 34	X 222 176 34
4	X 222 175 32	X 222 176 32
5	X 222 175 08	X 222 176 08
6	X 222 175 17	X 222 176 17
7	X 222 175 31	X 222 176 31
7.5	X 222 175 09	X 222 176 09
7 1/2	X 222 175 10	X 222 176 10
8	X 222 175 37	X 222 176 37
10	X 222 175 11	X 222 176 11
14	X 222 175 38	X 222 176 38
15	X 222 175 12	X 222 176 12
20	X 222 175 13	X 222 176 13
24	X 222 175 42	X 222 176 42
25	X 222 175 14	X 222 176 14
30	X 222 175 15	X 222 176 15
35	X 222 175 16	X 222 176 16
40	X 222 175 18	X 222 176 18
45	X 222 175 39	X 222 176 39
50	X 222 175 19	X 222 176 19
60	X 222 175 20	X 222 176 20
70	X 222 175 21	X 222 176 21
75	X 222 175 22	X 222 176 22
80	X 222 175 23	X 222 176 23
90	X 222 175 24	X 222 176 24
100	X 222 175 25	X 222 176 25
120	X 222 175 26	X 222 176 26
125	X 222 175 27	X 222 176 27
150	X 222 175 28	X 222 176 28
R	X 222 175 40	X 222 176 40

All dimensions without tolerances are for reference only. In the interest of improved design, performance and cost effectiveness the right to make changes in these specifications without notice is reserved. Product markings may not be exactly as the ordering codes. Errors and omissions excepted.