



DR22 SERIES | AC OUTPUT LOW-PROFILE

DIN RAIL MOUNT SOLID STATE RELAYS

Nova22 DR22 Series are last generation DIN Rail mount Solid State Relays in a 22.5mm wide industrial package. "Low-profile" versions come with an integral low-profile heat sink and a TRIAC output rated for up to 30 Amps at 280 VAC. This provides users with a cost-effective solution to switch small and medium AC loads that allows to reduce manufacturing cost and cabinet space without sacrificing performance, and to optimize equipment operation time.

These powerful and ready to use SSRs are perfect for applications where the depth of the control panel is limited, and they are UL approved and CE compliant.



NOVA22

Features

- Output ratings up to 30 Amps at 280 VAC
- Relay configuration
- Compact 22.5 mm wide package
- Snubber circuit
- Built-in overvoltage protection
- IP20 touch-safe housing
- Wide 3-32 VDC control input
- Integrated low-profile heatsink
- C-UL-US approved

Applications

- Industrial ovens
- Plastic injection molding equipment
- Packaging equipment
- Professional cooking equipment
- Lighting control
- HVAC&R



PRODUCT SELECTION

Control Voltage	20 A	30 A
3-32 VDC	DR2224D20Ux	DR2224D30Ux



SPECIFICATIONS

Output⁽¹⁾

Description	20 A	30 A
Operating Voltage (47-63 Hz) [Vrms]	24-280	24-280
Transient Overvoltage [Vpk] ⁽²⁾	600	600
Minimum Off-State dV/dt @ Maximum Rated Voltage [V/μsec]	500	500
Maximum Off-State Leakage Current @ Rated Voltage [mArms]	3	3
Load Current, General Use UL508 @40°C [Arms]	20	30
Load Current, Motor Starting UL508 FLA @40°C [Arms]	9.8	13.8
Minimum Load Current [mArms]	100	100
Maximum 1 Cycle Surge Current (50/60 Hz) [Apk]	400/440	
Maximum On-State Voltage Drop @ Rated Current [Vpk]	1.2	1.3

Maximum 1/2 Cycle I²t for Fusing (50/60Hz) [A²sec]	800/806	
Motor Rating UL 508 [HP (kW)]: 120 VAC	0.5 (0.37)	0.75 (0.55)
Motor Rating UL 508 [HP (kW)]: 240 VAC	1.5 (1.1)	2 (1.5)

Input⁽¹⁾

Description	DR2224Dxxxx
Control Voltage Range [VDC]⁽³⁾	3-32
Minimum Turn-On Voltage [VDC]	3
Must Turn-Off Voltage [VDC]	1
Minimum Input Current (for on-state) [mA]	8
Maximum Input Current [mA]	15
Nominal Input Impedance	Current Regulated
Maximum Turn-On Time⁽⁴⁾	1/2 Cycle
Maximum Turn-Off Time	1/2 Cycle
Maximum Turn-Off Time [μsec]	100

General⁽¹⁾

Description	Parameters
Dielectric Strength, Input to Output (50/60 Hz)	3750 Vrms
Dielectric Strength, Input/Output to Case (50/60 Hz)	2500 Vrms
Minimum Insulation Resistance (@ 500 VDC)	10 ⁹ Ohms
Maximum Capacitance, Input/Output	8 pF
Ambient Operating Temperature Range	-40 to 80 °C
Ambient Storage Temperature Range	-40 to 100 °C
Weight (typical)	9.17 oz (260 g)
Housing Material	UL94 V-0
Heat Sink Material	Aluminum
DIN Rail Clip Material	Zink Plated Steel
Hardware Finish	Nickel Plating
Humidity	95% non-condensing
Input and Output Terminal Screw Torque Range (lb-in/Nm)	13-15 / 1.5-1.7
LED Input Status Indicator	Green



INPUT CURRENT INFORMATION

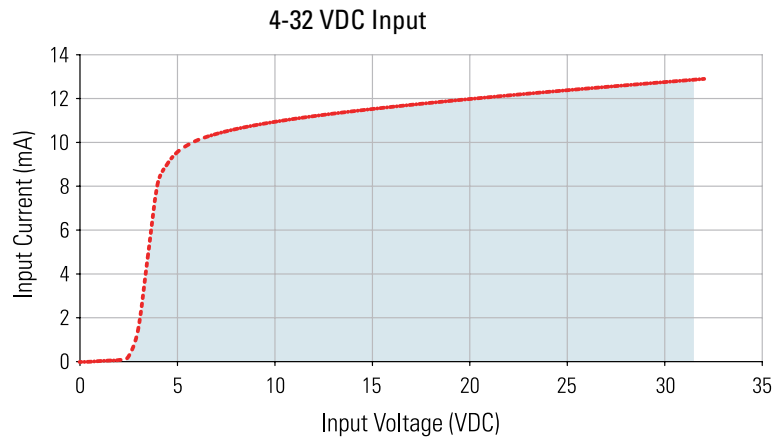

SURGE CURRENT INFORMATION

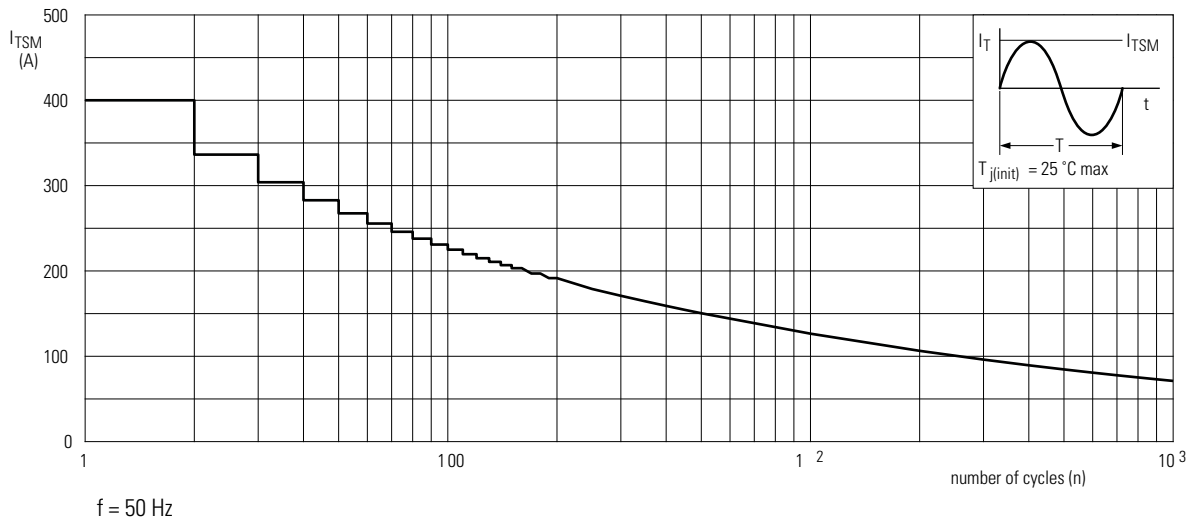

Non-repetitive peak on-state current as a function of the number of sinusoidal current cycles; maximum values.



THERMAL DERATE INFORMATION

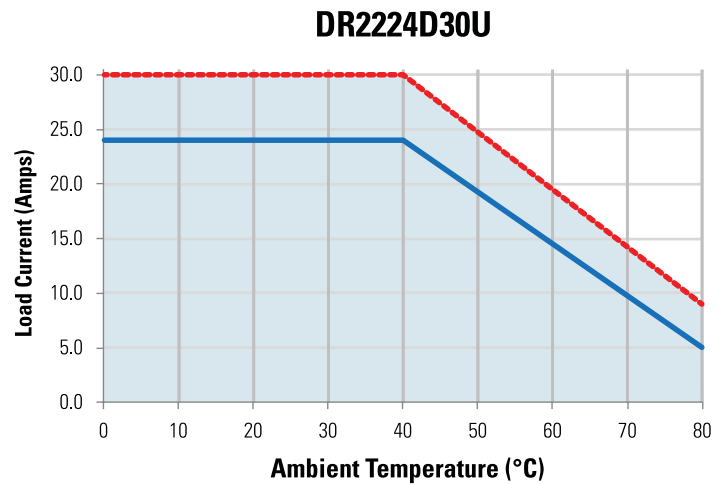
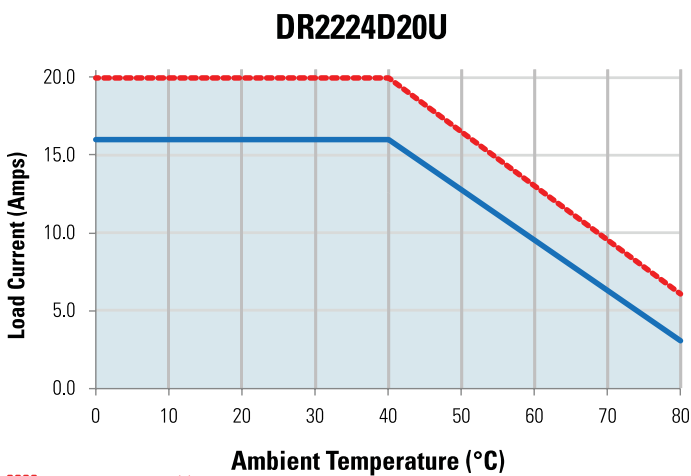

--- Single units⁽⁵⁾

— Multiple units, no minimum spacing between components



EQUIVALENT CIRCUIT BLOCK DIAGRAMS/WIRING DIAGRAM

Load can be wired to either terminal 1 or terminal 2.

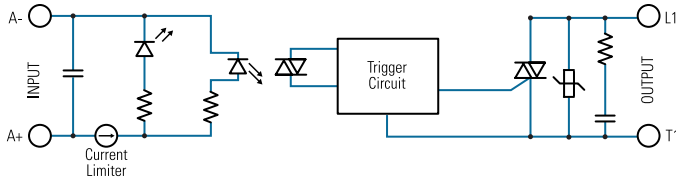

Recommended Wire Sizes		
Terminal Configuration	Wire Size (Solid / Stranded)	Wire Pull-Out Strength (lb)[N]
Output Relay "U" suffix	2 x 18 AWG (1 mm ²) Stranded	20 [88]
	2 x 10 AWG (6 mm ²) Stranded	60 [266]
Input Relay "U" suffix	2 x 18 AWG (1 mm ²) Stranded	20 [88]
	2 x 12 AWG (4 mm ²) Stranded	40 [177]



MECHANICAL SPECIFICATIONS

*Tolerances: ±0.02 in / 0.5 mm All dimensions are in: inches [millimeters]

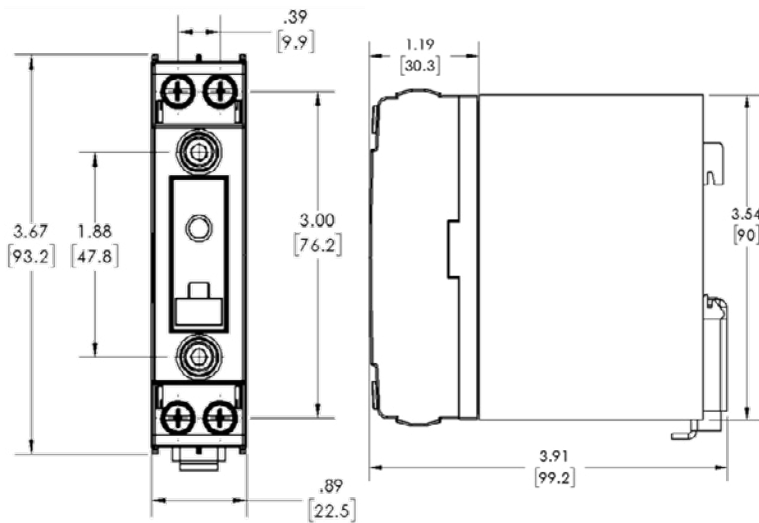

Protective Earth Connection

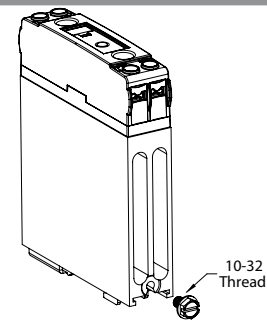

Protective Earth (PE) Screw Type recommended is 10-32 UNC standard not provided With SSR. Through the use of a DIN rail ground (protective conductor_ Terminal block, the DIN rail clip of DR22 models, permits a secure path to ground and avoid the need of further PE protection.

Compatible Terminal

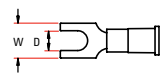
Terminal	
	Fork Lug
Width [W] in (mm)	0.45 (11.4)
Stud Size Dia [D] (in)	#8 (0.168)



ACCESSORIES

Recommended Accessories

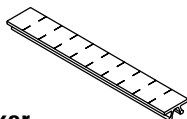

ID Marker

CNLB
CNLN
CNL2



AVAILABLE OPTIONS

Example : DR2224D20UR

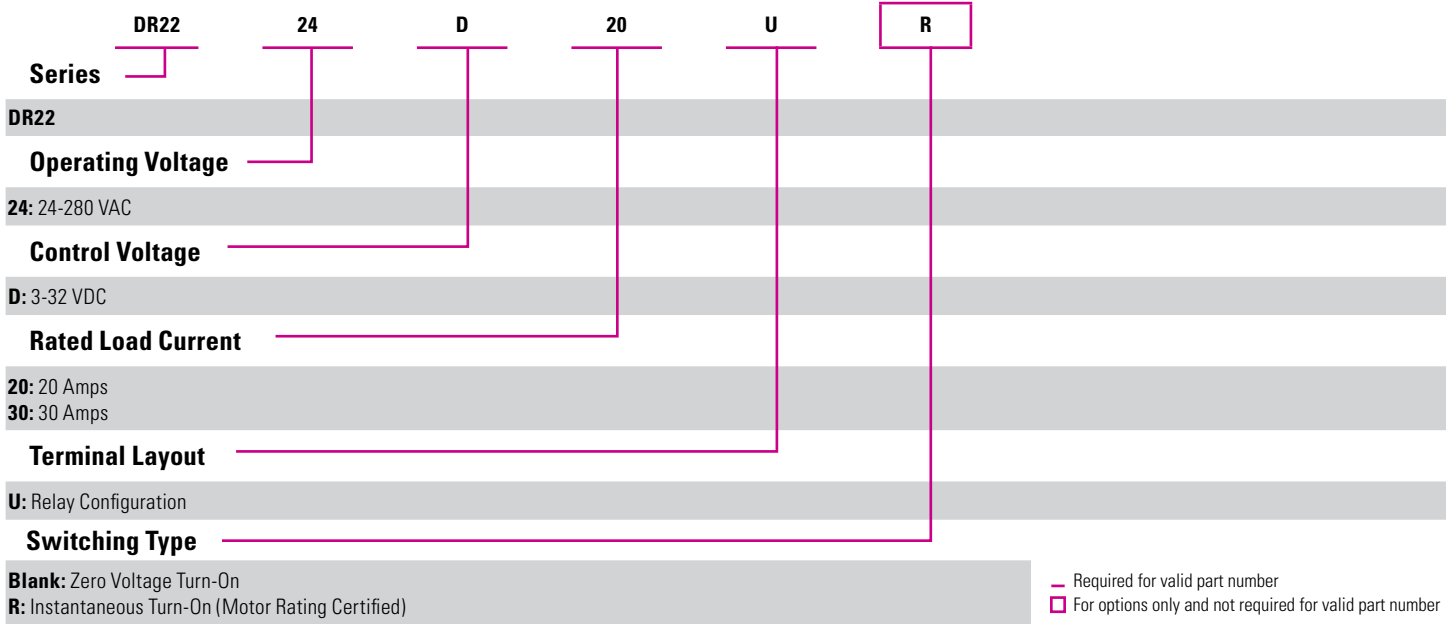

GENERAL NOTES

- (1) All parameters at 25°C unless otherwise specified.
- (2) Internal protection will activate between 440-540 Vpk, intended to protect power semiconductor for high frequency transient only. Internal damage can occur if device is operated beyond voltage limits.
- (3) Increase minimum voltage by 1 V for operations from -20 to -40°C.
- (4) Turn-on time for instantaneous turn-on versions is 0.1 msec.
- (5) Minimum spacing to obtain maximum current is 22.5mm between adjacent units.



AGENCY APPROVALS & CERTIFICATIONS

Certification in accordance with:
 United States Standard for Industrial Control Equipment - UL 508 and
 Canadian Standard Association for Industrial Control Equipment – C22.2 No. 14.



Electromagnetic Compatibility					
Generic Standard	Inmunity Tests	Test Specification Level		Performance	
IEC 61000-6-2 Immunity for Industrial Environments	Electrostatic Discharge IEC 61000-4-2	4kV air discharge		Criterion A	
		4kV contact discharge		Criterion A	
	Fast transients (burst) IEC 61000-4-4	Output	2kV, 5kHz, 100kHz		Criterion B
		Input	1kV, 5kHz, 100kHz		Criterion B
	Surge IEC 61000-4-5	Output	1kV Line to Earth		Criterion B
			2kV Line to Earth		Criterion B

WARNINGS



RISK OF MATERIAL DAMAGE AND HOT ENCLOSURE

- The product's side panels may be hot, allow the product to cool before touching
- Follow proper mounting instructions including torque values
- Do not allow liquids or foreign objects to enter this product

Failure to follow these instructions can result in serious injury, or equipment damage.



HAZARD OF ELECTRIC SHOCK, EXPLOSION OR ARC FLASH

- Disconnect all power before installing or working with this equipment
- Verify all connections and replace all covers before turning on power

Failure to follow these instructions will result in death or serious injury.

Sensata Technologies, Inc. ("Sensata") data sheets are solely intended to assist designers ("Buyers") who are developing systems that incorporate Sensata products (also referred to herein as "components"). Buyer understands and agrees that Buyer remains responsible for using its independent analysis, evaluation and judgment in designing Buyer's systems and products. Sensata data sheets have been created using standard laboratory conditions and engineering practices. Sensata has not conducted any testing other than that specifically described in the published documentation for a particular data sheet. Sensata may make corrections, enhancements, improvements and other changes to its data sheets or components without notice.

Buyers are authorized to use Sensata data sheets with the Sensata component(s) identified in each particular data sheet. HOWEVER, NO OTHER LICENSE, EXPRESS OR IMPLIED, BY ESTOPPEL OR OTHERWISE TO ANY OTHER SENSATA INTELLECTUAL PROPERTY RIGHT, AND NO LICENSE TO ANY THIRD PARTY TECHNOLOGY OR INTELLECTUAL PROPERTY RIGHT, IS GRANTED HEREIN. SENSATA DATA SHEETS ARE PROVIDED "AS IS". SENSATA MAKES NO WARRANTIES OR REPRESENTATIONS WITH REGARD TO THE DATA SHEETS OR USE OF THE DATA SHEETS, EXPRESS, IMPLIED OR STATUTORY, INCLUDING ACCURACY OR COMPLETENESS. SENSATA DISCLAIMS ANY WARRANTY OF TITLE AND ANY IMPLIED WARRANTIES OF MERCHANTABILITY, FITNESS FOR A PARTICULAR PURPOSE, QUIET ENJOYMENT, QUIET POSSESSION, AND NON-INFRINGEMENT OF ANY THIRD PARTY INTELLECTUAL PROPERTY RIGHTS WITH REGARD TO SENSATA DATA SHEETS OR USE THEREOF.

All products are sold subject to Sensata's terms and conditions of sale supplied at www.sensata.com SENSATA ASSUMES NO LIABILITY FOR APPLICATIONS ASSISTANCE OR THE DESIGN OF BUYERS' PRODUCTS. BUYER ACKNOWLEDGES AND AGREES THAT IT IS SOLELY RESPONSIBLE FOR COMPLIANCE WITH ALL LEGAL, REGULATORY AND SAFETY-RELATED REQUIREMENTS CONCERNING ITS PRODUCTS, AND ANY USE OF SENSATA COMPONENTS IN ITS APPLICATIONS, NOTWITHSTANDING ANY APPLICATIONS-RELATED INFORMATION OR SUPPORT THAT MAY BE PROVIDED BY SENSATA.

Mailing Address: Sensata Technologies, Inc., 529 Pleasant Street, Attleboro, MA 02703, USA.

CONTACT US

Americas

+1 (877) 502 5500
sales.crydom@sensata.com

Europe, Middle East & Africa

+44 (1202) 416170
ssr-info.eu@sensata.com

Asia Pacific

sales.isasia@list.sensata.com
China +86 (21) 2306 1500
Japan +81 (45) 277 7117
Korea +82 (31) 601 2004
India +91 (80) 67920890
Rest of Asia +886 (2) 27602006
ext 2808