

Cable Reels

Heavy Duty Industrial Weatherproof Reels

HUBBELL

Features

- Ratchet lock can be disengaged in field
- Optional pivot base allows 340° rotation of reel
- Multi-position roller guide can be mounted in four different positions

Ordering Information

Description	Color	UPC Number	Catalog Number
14" yellow weatherproof reel	Yellow	783585209104	HBL501431W

Listings

UL 355 and CSA
C22.2 No. 308

Specifications

Amperage	15
Volts AC	600
Cable Length Feet (m)	50 (15.2)
Cable Type	14/3 SOW-A
Weight Lbs. (kg)	55 (24.9)

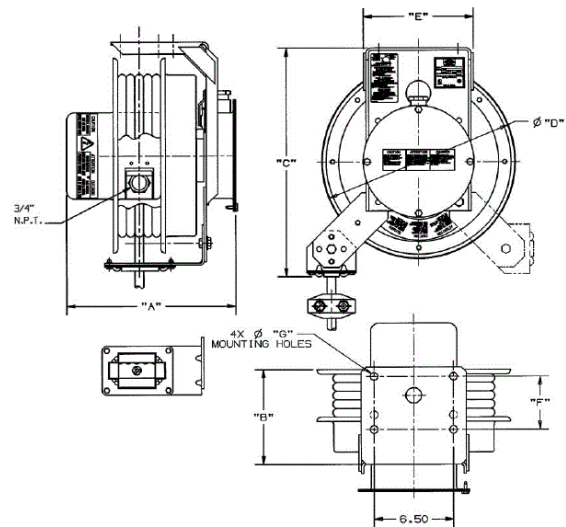

Online Resources

Customer Sales Drawings
eCatalog
Installation Instructions

Dimensions in Inches (mm)

Hubbell Wiring Device-Kellems • Hubbell Incorporated (Delaware) • 40 Waterview Drive • Shelton, CT 06484

Phone (800) 288-6000 • Fax (800) 255-1031 • Specifications subject to change without notice.

