

DRAWING NUMBER: 1106571
 REVISION: K

CABLE CUTTING

- CABLE SOURCE :
 1. TA HSING(SHENZHEN).
 2. BAO HING(SHENZHEN).
 3. VOLEX(TA HSING)

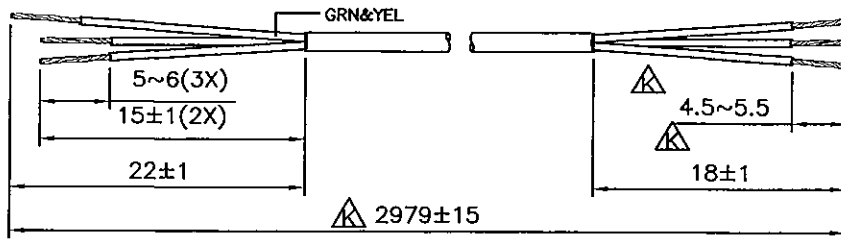

ASSEMBLY :

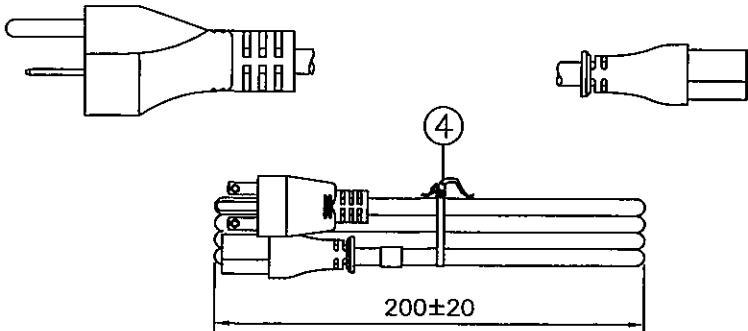
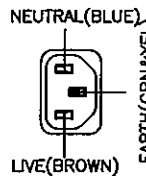
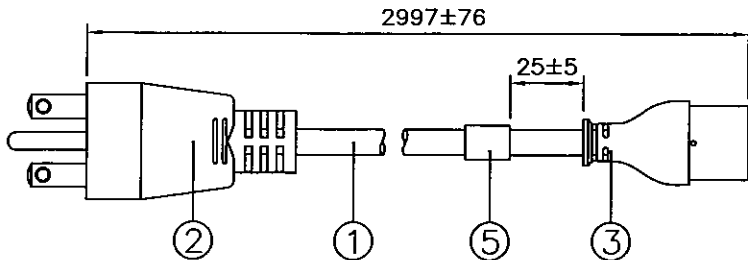
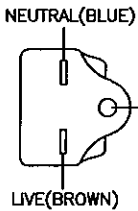

Notes :

- ALL DIMENSIONS IN mm.
- PLUG AND CONNECTOR MARKING : REFER TO MARKING DRAWING NO. : VP-0145C AND VC-1704 RESPECTIVELY.
- PLUG AND CONNECTOR DETAILS : REFER TO PRODUCT DRAWING NO. : P-0323 AND C-0362 RESPECTIVELY.
- LABEL DETAILS : REFER TO LABEL DRAWING NO. : VL-0356.
- CARTON BOX MUST HAVE A LABEL/STAMP SAYING : "THIS PACKAGE CONTAINS CORDS HAVING GROUNDING CONDUCTOR WITH GREEN/YELLOW COLOUR INSULATION, NEUTRAL CONDUCTOR WITH BLUE COLOUR INSULATION AND LIVE CONDUCTOR WITH BROWN COLOUR INSULATION".
- THIS PART CAN BE MANUFACTURED AT ANY LOCATION WHICH HAS SAFETY APPROVAL.
- THIS PART ONLY HAS UL/C-UL APPROVAL.

REV.	ECR REF. NO.	DESCRIPTION	DATE
J	170207	ADD 'VOLEX-JEM(DONGGUAN)' AS THE FIRST ALTERNATE CABLE SOURCE.	14/06/17
		REMOVE ITEM NO. '1810287' ON PAGE 1.	
		CHANGE LENGTH FROM '2977' TO '2979' ON PAGE 1.	
		CHANGE CUTTING LENGTH DIMENSIONS FM. '17~20 & 6~7' TO '18±1 & 4.5~5.5' ON PAGE 1.	
		CHANGE ITEM NO. FROM '386A & 4100098' TO 'VNBC13S-4 & 4100017' ON PAGE 1.	
		REMOVE VOLEX-JEM & TONG YUAN & WONDERFUL.	
		UPDATE NOTE 2 & 3 AND ADD NOTE 7 ON PAGE 1.	
		CHANGE TITLE FM. 'RoHS COMPLIANT' TO 'CS-LF0001'.	
K	210142	ADD IN CABLE SOURCE OF VOLEX(TA HSING)	14/04/21

5	PRINTED LABEL	VL-0356	1
4	8" PE TIE BLK	6310062	1
3	IP40G NL792B BLK	4100017	-
	MOLDED CONNECTOR VNBC13S (10A 250V)	VNBC13S-4	1
2	IP40G NL792B BLK	4100017	-
	MOLDED PLUG VS205S (10A 250V)	VS205S-13	1
1	SVT 18/3 60°C BBGY BLK PVC LEAD FREE	1810121	2.979M

S/N	DESCRIPTION	ITEM NUMBER	QTY
TITLE : NORTH-AMERICAN POWER SUPPLY CORDSET (CS-LF0001)		PAGE : 1/2	
CUSTOMER : VIS/VOLEX INC		HG01-158-07	
CUSTOMER PART NUMBER : 17567 1Ø C3		DWG. TYPE	
F/G CODE : 17567 1Ø C3		SPEC NO. : ---	OED
SALES : N.A.	QA : N.A.	ENGRG : Feng	CHECKED BY : ALLIE
DATE : N.A.	DATE : N.A.	DATE : 15/4/21	DATE : 14/04/21

VoLEX (Asia) Pte Ltd
 Confidential property of VoLEX.
 Information contained herein shall not be disclosed to others, reproduced or used for any other purpose except as authorized in writing by an authorized official of VoLEX Asia.

DRAWING NUMBER :

1106571

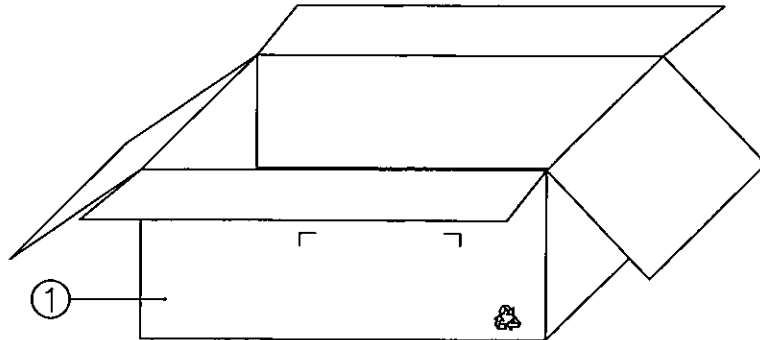
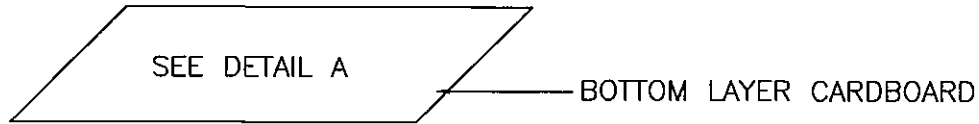
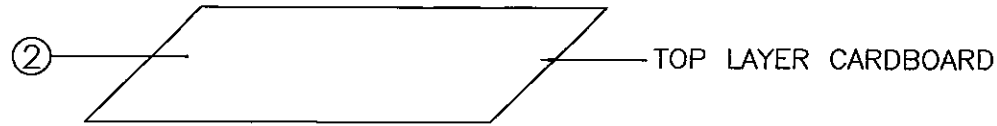

PACKAGING INSTRUCTION

1. ALL CORDSETS LAYOUT AS DETAIL.
2. PACKAGING : 25 PCS PER CARTON.

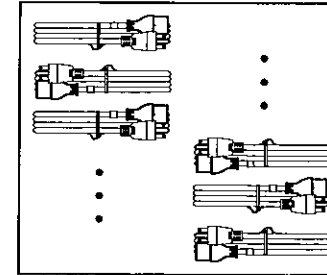

DETAIL A

NOTE :

1.) ALL DIMENSIONS IN mm.

2	CARTON LAYER PAD 420X350MM	901022	0.08
1	CARTON 430X360X160 RL1086	901015	0.04
S/N	DESCRIPTION	ITEM NUMBER	QTY

REVISION	K	TITLE : PACKAGING SPEC.	
PAGE	2/2		
SCALE	N.T.S.		

REFERENCE :	<i>Volex (Asia) Pte Ltd</i>		
DESCRIPTION : CARTON BOX			
<small>Confidential property of Volex. Information contained herein shall not be disclosed to others, reproduced or used for any other purpose except as authorized in writing by an authorized official of Volex Asia.</small>			