

EXPC-1319 Series

Award-winning Product



Fanless rugged Zone 2 19-inch 1000-nit LCD panel computers with touch screen



- > Zone 2 certified for hazardous area applications
- > High performance / low power Intel dual core Atom D525 1.8 GHz CPU
- > Anti-scratch 19-inch sunlight-viewable 1000-nit LCD panel
- > Self-health diagnostics software package for remote predictive maintenance
- > -40 to 60°C extended operation temperature (with built-in Intelligent Heater)
- > Completely sealed IP66 / NEMA 4X panel computer
- > Fanless, streamlined enclosure for highly-efficient heat dissipation
- > Touch screen control button to enable/disable touch screen interface
- > Optional WLAN, 100M Fiber optic connection



Introduction

The EXPC-1319 panel computers are fanless, durable devices made for both indoor and outdoor hazardous environments. The EXPC-1319 series features the Intel Atom dual core D525 1.8 GHz processor, with up to 4 GB of memory available to deliver high performance processing. The EXPC-1319 is Zone 2 certified, and comes with two electrically isolated, software-selectable RS-232/422/485 serial ports alongside two gigabit LAN ports, providing reliable serial and high speed Ethernet LAN transmissions with full network redundancy.

The EXPC-1319 computers come with a patented, fanless, streamlined enclosure designed for highly efficient heat dissipation, making this one of the most reliable industrial platforms available for harsh, hot outdoor environments like oil and gas fields, or drilling platforms. In addition, EXPC-1319 computers come with a self-health diagnostics software that can communicate over SNMP and has an expanded set of features. You can also order this software along with Moxa's Intelligent Heating Solution (IHS), a heating utility for use in extremely low temperature (-40°C) environments. Finally, these computers feature touchscreen controls with glass-film-glass bonding, making them scratch- and glare-resistant and easy to read even during the peak daylight hours.

Appearance

Front and Side Views

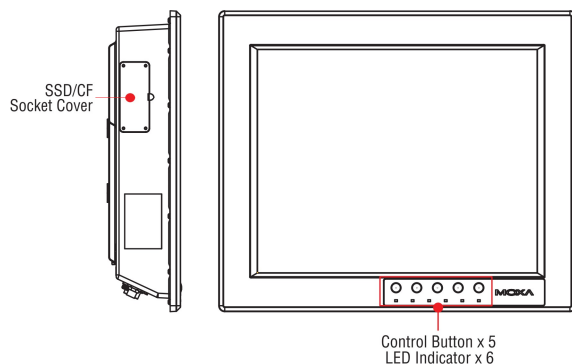

Rear and Bottom Views

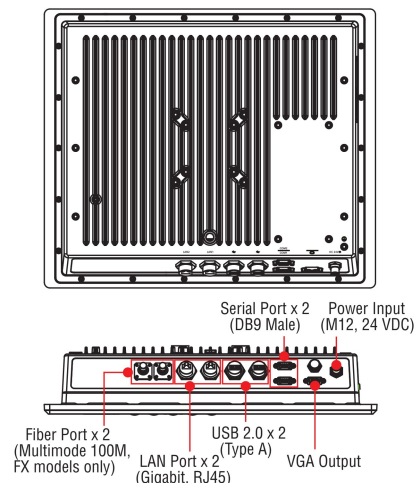

Dimensions

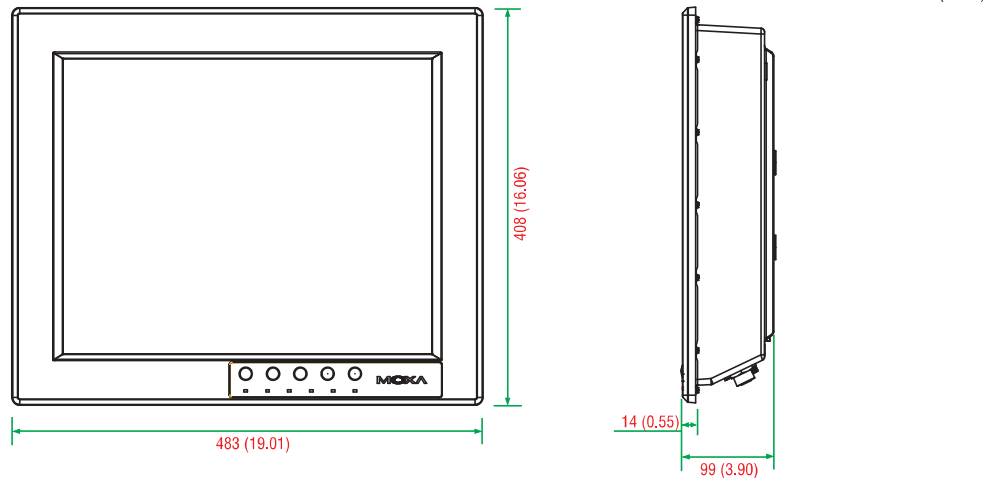

Hardware Specifications

Computer

CPU: Intel Atom D525 dual core 1.8 GHz processor

OS: Windows Embedded Standard 7

System Chipset: Intel Pineview-D+ ICH8M

BIOS: 16 Mbit Flash BIOS, SPI type with ACPI

FSB: Intel GMA3150 integrated graphics controller

Video Output: VGA output, waterproof DB-15 (female) connector

System Memory: 4 GB capacity, 2 GB pre-installed: 2 slots of 2 GB DDR3-800 SO-DIMM SDRAM

Automatic Reboot Trigger: Built-in software-programmable watchdog timer for system resets, configurable from 1 to 255 second timeout intervals

Expansion Bus: 1 PCI-104 slot, 1 mini PCIe socket

USB: 2 USB 2.0 hosts, waterproof circular type-A connector

KB/MS: PS/2 interface supports both keyboard and mouse via Y type cable, waterproof connector (optional)

Storage

Storage Expansion:

- Onboard CompactFlash socket x 1
- One extra onboard SATA interface, supporting configurable RAID 0/1

Storage Support: Removable 32 GB industrial grade SSD (operating temperature: -40 to 85°C) to store OS; supports up to 256 GB

Display

Panel Size: 19-inch SXGA, 1000-nit LED backlight LCD

Aspect Ratio: 5:4

Response Time: 5 ms

Contrast Ratio: 1000:1

Viewing Angles:

- Horizontal: 170° (left to right)
- Vertical: 160° (up to down)

Max Colors: 16.7 M colors

Graphics Controller: Integrated Intel GMA3150 graphics controller

Video Output: VGA output, waterproof DB15 (female) connector

Resolution:

- VGA: 640 x 480
- SVGA: 800 x 600
- XGA: 1024 x 768
- SXGA: 1280 x 1024

Touchscreen

EXPC-1319-ST5: Resistive single point glass-film-glass

Note: All EXPC-1319 touchscreens are scratch resistant and anti-glare, suitable for use outdoors around heavy equipment.

Ethernet Interface

Hardware Interface: Waterproof RJ45 connector

LAN: 2 auto-sensing 10/100/1000 Mbps ports

Optical Fiber Interface: 2 multimode 100M fiber-optic ports with waterproof Q-ODC connector (FX models only)

WLAN: 1 802.11b/g/n interface (available on request)

Magnetic Isolation Protection: 1.5 kV, built-in

Serial Interface

Serial Standards: 2 RS-232/422/485 ports, software-selectable

Connector Type: Waterproof DB9 (male)

Baudrate: Up to 38,400 bps

Isolation Protection: 2 kV

Serial Communication Parameters

Data Bits: 5, 6, 7, 8

Stop Bits: 1, 1.5, 2

Parity: None, Even, Odd, Space, Mark

Flow Control: RTS/CTS, XON/XOFF, ADDC® (automatic data direction control) for RS-485

Baudrate: Up to 38,400 bps

Serial Signals

RS-232: TxD, RxD, DTR, DSR, RTS, CTS, DCD, GND

RS-422: TxD+, TxD-, RxD+, RxD-, GND

RS-485-4w: TxD+, TxD-, RxD+, RxD-, GND

RS-485-2w: Data+, Data-, GND

LEDs and Buttons

LEDs: Power on/off, heater on/off, storage, LAN port communication x 2, fiber communication

Control Buttons: System on/off, brightness adjustment x 2, touchscreen on/off, programmable "Fn" button

Physical Characteristics

Housing: Aluminum

Weight:

- 10.7 kg (23.78 lb) (without Intelligent Heating Solution)
- 11.9 kg (26.44 lb) (with Intelligent Heating Solution)

Dimensions: 483 x 408 x 99 mm (19.02 x 16.06 x 3.90 in)

Mounting: Yoke, panel, mounting holes for VESA 75/100-mounting

Environmental Limits

Operating Temperature:

- Without Intelligent Heating Solution: -20 to 60°C (-4 to 140°F)
- With Intelligent Heating Solution: -40 to 60°C (-40 to 140°F)

Storage Temperature: -40 to 80°C (-40 to 176°F)

Ambient Relative Humidity: 5 to 95% (non-condensing)

Anti-Vibration: 2 Grms, 5-500 Hz frequency, compliant with IEC 60068-2-6 standard

Anti-Shock: 20 g, half sine wave under system operating, 11 ms duration, compliant with IEC 60068-2-27 standard

Power Requirements

Input Voltage:

- Typical 24 VDC
- External 100 to 240 VAC isolated power supply unit (available on request)

Connector: M12, customizable

Power Consumption:

- Without Intelligent Heating Solution: 60 W
- With Intelligent Heating Solution: 120 W

Standards and Certifications

Hazardous Environments: UL Class 1 Division 2, ATEX Zone 2, IECEx

EMC: EN 55032 Class B, EN 55024, FCC Part 15 Subpart B Class A

Mechanical: IP66, NEMA 4X

Green Product: RoHS, cRoHS, WEEE

Warranty

Warranty Period: 3 years for computer system, 1 year for LCD panel

Details: See www.moxa.com/warranty

Software Specifications

Windows Embedded Standard 7

Core OS:

- 32-bit support
- Remote Client
- Remote Procedure Call

Applications and Services Development:

- .Net Framework 3.5
- Remote Desktop Protocol 7.1
- COM OLE Application Support
- COM+ Application Support
- MSMQ

Internet Services:

- Internet Explorer 8.0
- IIS 7.0

Diagnostics:

- Common Diagnostic Tools
- Problem Reports and Solutions

Fonts: Chinese (Trad. and Simp.), Japanese, Korean, Western, Middle Eastern, South East Asian, and South Asian Fonts

Graphics and Multimedia:

- MPEG DTV-DVD Audio Decoder (MPEG-2, AAC)
- MPEG Layer-3 Audio Codecs(MP3)
- MPEG4 Decoders
- Windows Media Video VC-1 (WMV) Codecs
- DirectX and Windows Device Experience
- Windows Media Player 12

International:

- IME Simplified Chinese Support
- IME Traditional Chinese Support

Management:

- Group Policy Management
- Windows Management Instrument (WMI)
- Windows Update

Networking:

- Extensible Authentication Protocol (EAP)
- Internet Authentication Service
- Telnet Server
- Bluetooth
- Domain Services
- Network Access Protection
- Network and Sharing Center
- Quality of Service
- Remote Access Service (RAS)
- Telephony API Client
- Windows Firewall
- Wireless Networking

Security:

- Credential Roaming Service
- Credentials and Certificate Management
- Windows Authorization Manager (AZMAN)
- Windows Security Center
- Active Directory Rights Management
- Security Base
- Encrypted File System (EFS)

Embedded Features:

- Enhanced Write Filter (EWF)
- File-Based Write Filter (FBWF)
- Message Box Default Reply
- Registry Filter
- WSDAPI for .NET

File Systems and Data Store:

- Windows Data Access Components
- Windows Backup and Restore

Embedded Self-Health Diagnostic Software: SNMP-based remote scripting layer for monitoring, reporting, and control

Ordering Information

Available Models

EXPC-1319-ST5-W7E: Fanless rugged Zone 2 19-inch 1000-nit LCD panel computer, single point touchscreen, IP66, Atom D525 dual core 1.8 GHz CPU, -20 to 60°C operating temperature

EXPC-1319-ST5-IHS-W7E: Fanless rugged Zone 2 19-inch 1000-nit LCD panel computer, single point touchscreen, IP66, Atom D525 dual core 1.8 GHz CPU, -40 to 60°C operating temperature, with Intelligent Heating Solution (IHS)





EXPC-1319-ST5-FX-W7E: Fanless rugged Zone 2 19-inch 1000-nit LCD panel computer, single point touchscreen, IP66, optical fiber ports, Atom D525 dual core 1.8 GHz CPU, -20 to 60°C operating temperature

EXPC-1319-ST5-IHS-FX-W7E: Fanless rugged Zone 2 19-inch 1000-nit LCD panel computer, single point touchscreen, IP66, optical fiber ports, Atom D525 dual core 1.8 GHz CPU, -40 to 60°C operating temperature, with Intelligent Heating Solution (IHS)

Package Checklist

- 1 EXPC-1319 panel computer
- Ethernet cable: RJ45 to RJ45 cross-over cable, 100 cm
- Waterproof USB connector pack x 2
- Waterproof DB9 connector pack x 2
- Waterproof LAN connector pack x 2
- Waterproof power connector pack x 1
- Wall-mounting kit
- Quick installation guide
- Documentation and software DVD
- Warranty card

Optional Accessories (can be purchased separately)

| Connector | Item | Model Name | Description |
|---|------|--|---|
|  | 1 | A-PLG-WPRJ-IP67-01 | Screw-type IP67-rated RJ45 connector for field installation |
|  | 2 | A-PLG-WPUSBA-IP67-01 | Screw-type IP67-rated USB type A male connector for field installation |
|  | 3 | A-PLG-WPF9-IP67-01 | Screw-type IP67-rated D-Sub 9-pin female connector for field installation |
|  | 4 | M12A-5P-IP68 | Screw-type IP68-rated A-coded 5-pin female M12 power connector for field installation |
| Power | | | |
|  | 1 | CBL-Power Jack to M12 | Power-jack-to-M12 cable |
|  | 2 | PWR-24250-DT-S1 | Power adapter for testing and system development in ambient office temperature conditions Input: 100 to 240 VAC, 50 to 60 Hz, 1.5 A Output: 24 VDC, 2.5 A, 60 W |
|  | 3 | PWC-C7US-2B-183 | Power cord with 2-pin connector, USA plug |
|  | 4 | PWC-C7EU-2B-183 | Power cord with 2-pin connector, Euro plug |
|  | 5 | PWC-C7UK-2B-183 | Power cord with 2-pin connector, British plug |
|  | 6 | PWC-C7AU-2B-183 | Power cord with 2-pin connector, Australia plug |
|  | 7 | PWC-C7CN-2B-183 | Power cord with 2-pin connector, China plug |
| Mounting Kit | | | |
|  | 1 | Pack/EXPC-1319/WKx2/TMSx6/M4x10mm Nylok | Wallmount kit x 2 |
|  | 2 | Pack/EXPC-1319/FKx2/PADx1/SCx16/Spacerx8 | Panel mounting kit |