



KT-WPLED35-M1-8CSB-VDIM

TRADITIONAL 35W NON-CUTOFF LED WALL PACK

DESCRIPTION

Traditional 35W Non-Cutoff LED Wall Pack | 120–277V Input | 3000–5000K | Medium-Size Bronze Housing | Glass Lens

APPLICATION

Building Mount for exterior illumination (perimeters, pathways, loading docks, and other general security lighting requirements)



PRODUCT FEATURES

- Traditional design matches appearance and light distribution pattern of legacy HID, optimized for one-for-one replacements
- Heavy-duty, die-cast aluminum housing with (5) available 1/2" threaded conduit hubs: (1) on back and (1) on all four sides
- Powered by Keystone 0–10V dimming LED drivers
- Keystone Color Select Technology: Adjustable CCT (3000K, 4000K, or 5000K)
- Built-in dusk-to-dawn photocell behind translucent 3/4" threaded plug with anti-yellowing agent
- Borosilicate glass lens diffuses light source and provides uniform distribution
- Covers footprint of mid-size HID wallpacks
- Ambient operating temperature: –20°C/–4°F to 45°C/113°F
- UL listed for wet locations, IP65
- 0–10V dimming, 10% min
- Power Factor: >0.95
- THD: <20%
- LED chip lifetime: L70 >100,000 hrs @ 25°C/77°F ambient fixture temp
- Meets FCC Part 15, Part B, Class A standards for conducted and radiated emissions

ELECTRICAL SPECIFICATIONS

Catalog Number	Wattage	Lumens	Lumens Below 90°	Dimming	CCT*	Efficacy	CRI	Housing Color	Input Voltage	Rated Life	Legacy Equivalent
KT-WPLED35-M1-8CSB-VDIM	35W	4865 lm	3955 lm	0–10V	3000K	139 lm/W	>80	Bronze	120–277V	50,000 hrs	150W MH
		5040 lm	4100 lm		4000K	144 lm/W					
		4690 lm	3815 lm		5000K	134 lm/W					

* Color Uniformity: CCT (Correlated Color Temperature) range as per guidelines outlined in ANSI C78.377-2017

KT-WPLED35-M1-8CSB-VDIM
TRADITIONAL 35W NON-CUTOFF LED WALL PACK

PHOTOMETRIC SPECIFICATIONS

ISOCANDELA PLOT

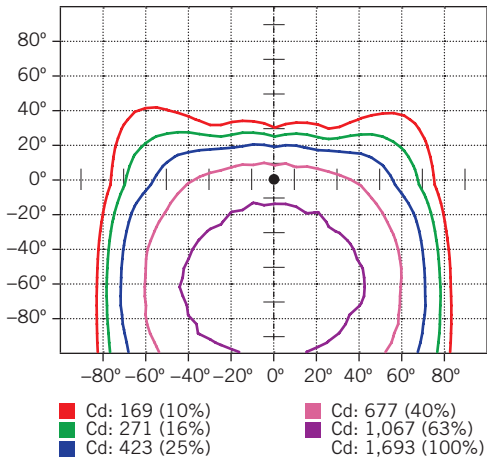

LUMINOUS INTENSITY DISTRIBUTION

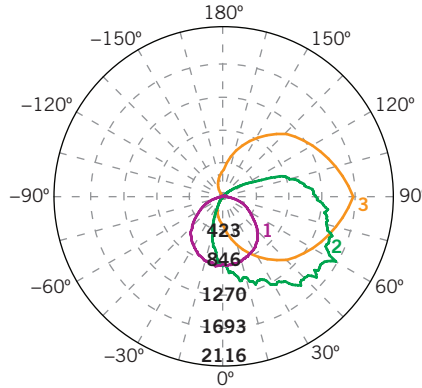

Average diffuse angle (50%): **111.0°**

- 1 Violet C0-C180
- 2 Green C90-C270
- 3 Orange G60

Unit: cd

FLUX DISTRIBUTION

Zone	Lumens	% Luminaire
Forward Light	3,122 lm	68.0%
0°-30°	441 lm	9.6%
30°-60°	1,269 lm	27.7%
60°-80°	981 lm	21.4%
80°-90°	430 lm	9.4%
Back Light	559 lm	13.1%
0°-30°	253 lm	5.5%
30°-60°	259 lm	5.7%
60°-80°	76 lm	1.6%
80°-90°	11 lm	0.2%
Up Light	867 lm	18.9%
90°-100°	357 lm	7.8%
100°-180°	510 lm	11.1%

BUG* Rating

Asymmetrical Luminaire Types	
Type I, II, III, IV	B1 U5 G3
Quadrilateral Symmetrical Luminaire Types	
Type V, Area Light	B1 U5 G3

* Backlight, Uplight, Glare

MOUNTING

Side view

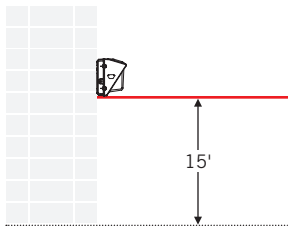

LIGHT DISTRIBUTION PATTERN

Isometric view from above; Luminaire mounted at 15'

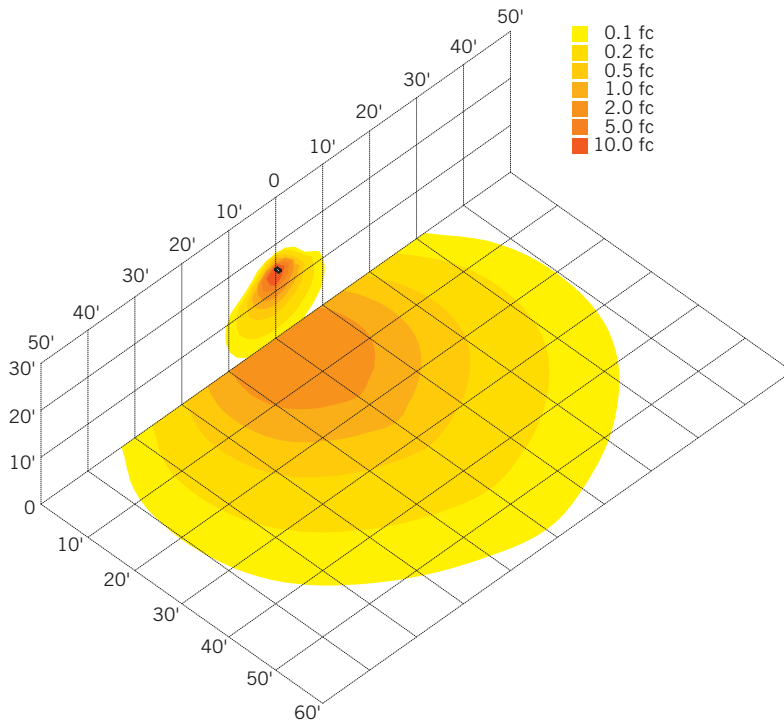



KT-WPLED35-M1-8CSB-VDIM

TRADITIONAL 35W NON-CUTOFF LED WALL PACK

PHYSICAL SPECIFICATIONS

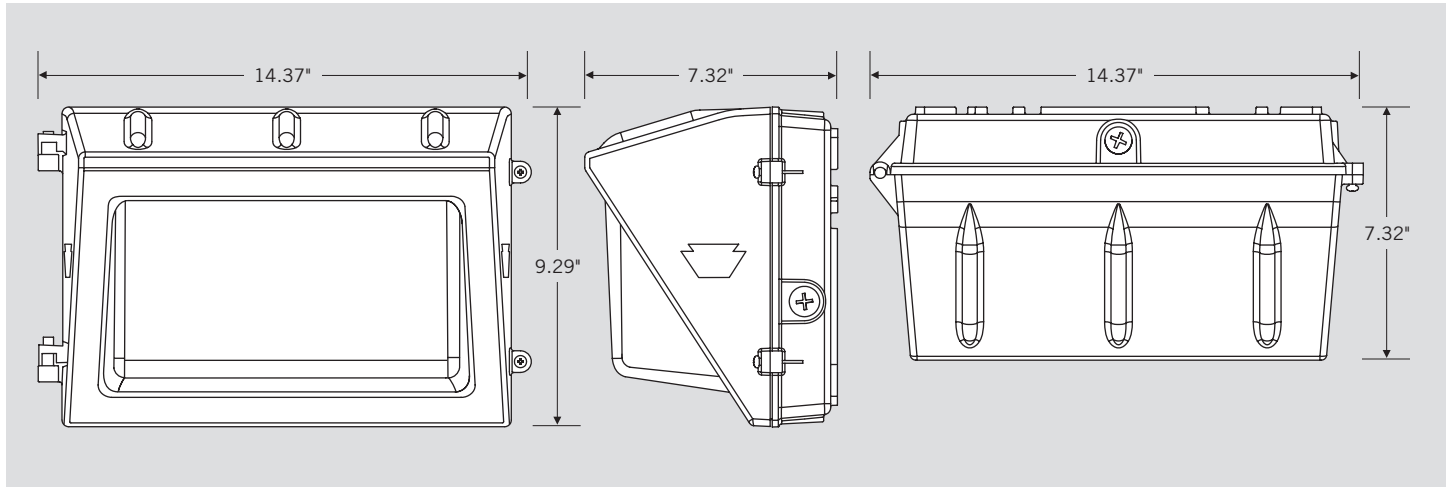

GENERAL SETUP INSTRUCTIONS

GENERAL WIRING DIAGRAM

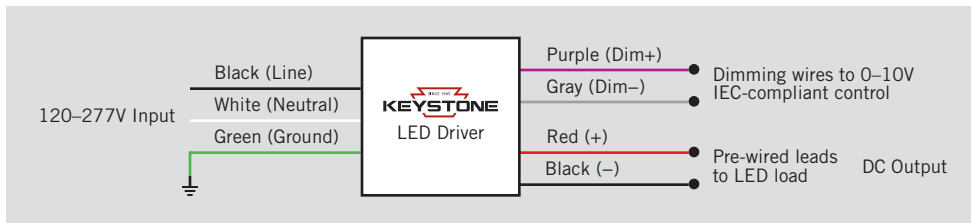

Caution: Before installing, make certain that AC power to the fixture is off.

Caution: The electrical rating of this product is 120-277V. Installer must confirm that there is 120-277V at the fixture before installation.

PHOTOCELL ENABLE/DISABLE

This fixture is equipped with a dusk-to-dawn photocell behind the translucent knock-out (KO) cover. Adjust the dip switch to enable (ON) or disable (OFF) the photocell function (see illustrations to the right). Fixture comes preset with photocell enabled unless otherwise noted.

COLOR SELECT (CCT) ADJUSTMENT

This fixture is equipped with Color Select technology. There is an adjustable dip switch behind the translucent knock-out (KO) cover to change CCT between 5000K, 4000K, and 3000K (see illustrations to the right). Fixture comes preset at 5000K unless otherwise noted.

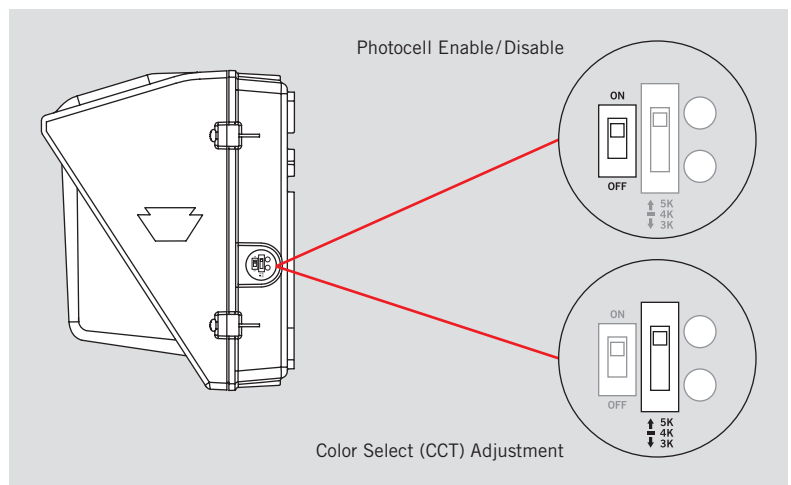



KT-WPLED35-M1-8CSB-VDIM

TRADITIONAL 35W NON-CUTOFF LED WALL PACK

ACCESSORY (SOLD SEPARATELY)

Catalog Number	Description
KTSP-10KV-C	Wallpack 10kV Surge Protector, Compact Design

ORDERING INFORMATION

ORDER CODE	PACK QTY.	ITEM STATUS
KT-WPLED35-M1-8CSB-VDIM	1	Quick Ship

CATALOG NUMBER BREAKDOWN

KT-WPLED35-M1-8CSB-VDIM

- 1
- 2
- 3
- 4
- 5
- 6
- 7
- 8
- 9
- 10

- 1** Keystone Technologies
- 2** Fixture Type
- 3** LED Lamp
- 4** Max Wattage
- 5** Size
- 6** Style
- 7** CRI
- 8** Color
- 9** Color Select Designation
- 10** Dimming

2 Fixture Type

F	Flood
WP	Wallpack

5 Size

S	Small
M	Medium
L	Large

6 Style

1	Non-Cutoff
2	Full-Cutoff

7 CRI

8	>80
9	>90

8 Color

40	4000K
50	5000K
CS	Color Select

9 Color Select Designation

A	3500K, 4000K, 5000K
B	3000K, 4000K, 5000K
C	3000K, 3500K, 4000K, 5000K
D	TBD

10 Dimming

VDIM	0-10V
------	-------