

MODEL G306K - G3 KADET OPERATOR INTERFACE WITH 5.6" TFT DISPLAY

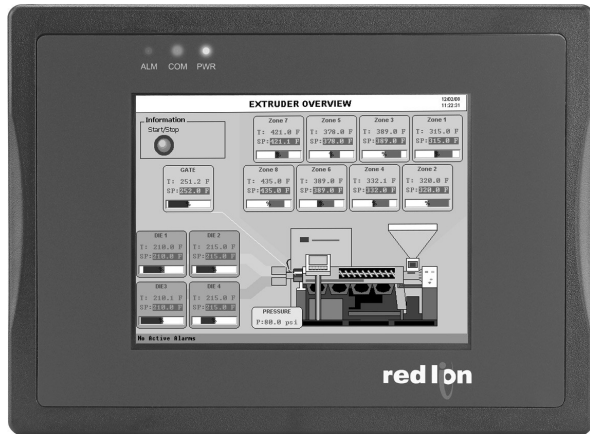

- CONFIGURED USING CRIMSON® 2.0 SOFTWARE
- THREE SERIAL COMMUNICATIONS PORTS (1 RS-232 AND 2 RS-232/422/485 PORTS)
- 10 BASE-T ETHERNET PORT COMMUNICATES WITH UP TO FOUR PROTOCOLS SIMULTANEOUSLY
- UNIT'S CONFIGURATION IS STORED IN NON-VOLATILE FLASH MEMORY
- COMPACTFLASH® SOCKET FOR LOADING DATABASE IN FIELD
- 5.6-INCH TFT ACTIVE MATRIX 256 COLOR QVGA 320 X 234 PIXEL DISPLAY
- NEMA 4/IP65 FRONT PANEL
- THREE FRONT PANEL LED INDICATORS
- POWER UNIT FROM 12 - 24 VDC
- RESISTIVE ANALOG TOUCHSCREEN



GENERAL DESCRIPTION

The G306K is the perfect solution for applications that require the operator to monitor and control more than just a single device. With three serial ports and an Ethernet port, the 5.6" Kadet can connect to multiple serial and Ethernet devices simultaneously, including PLCs, motor drives, bar code scanners, etc.

The G306K performs the functions of a multiple protocol converter, using three high-speed RS-232/422/485 communications ports and a 10 Base-T Ethernet port. The Ethernet port supports up to four protocols simultaneously, allowing dissimilar Ethernet based products to communicate with one another.

The CompactFlash slot can be used to load the unit's configuration file, allowing configuration changes to be made and saved to the card for later transfer.

The G3 Kadet range of HMIs is programmed with Red Lion's free Crimson 2.0 software. Crimson 2.0 offers easy to use drag and drop communications configuration, while the embedded image library allows the programmer to create intuitive screens and prompts for the operator.

SAFETY SUMMARY

All safety related regulations, local codes and instructions that appear in the manual or on equipment must be observed to ensure personal safety and to prevent damage to either the instrument or equipment connected to it. If equipment is used in a manner not specified by the manufacturer, the protection provided by the equipment may be impaired.

Do not use the controller to directly command motors, valves, or other actuators not equipped with safeguards. To do so can be potentially harmful to persons or equipment in the event of a fault to the unit.

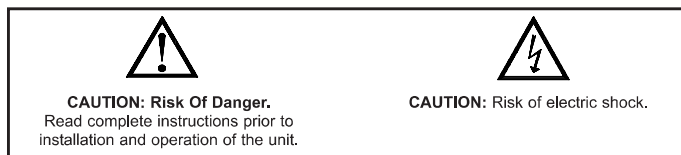

CONTENTS OF PACKAGE

- G306K Operator Interface.
- Hardware packet for mounting unit into panel.
- Terminal block for connecting power.
- Spare fuse.

ORDERING INFORMATION

MODEL NO.	DESCRIPTION	PART NUMBER
G306K	5.6" TFT Operator Interface	G306K000
G3CF	64 MB CompactFlash Card ⁴	G3CF064M
	256 MB CompactFlash Card ⁴	G3CF256M
	512 MB CompactFlash Card ⁴	G3CF512M
SFCRM2	Crimson 2.0 ¹	SFCRM200
CBL	USB to RS-232 Adaptor, includes "y" cable (CBLSK000)	CBLUSB23
	Communications Cables and Adaptors ²	CBLxxxxx
G3FILM	Protective Films	G3FILM6K
	Fuse	G3FUSE00
	Replacement Battery ³	BNL30000

¹ Use this part number to purchase the Crimson® software on CD with a printed manual and cables for the G3 and Kadet series HMIs. Otherwise, download for free from www.redlion.net.

² Contact your Red Lion distributor or visit our website for selection of adaptors and cables.

³ Battery type is lithium coin type CR2032.

⁴ Industrial grade two million write cycles.

CompactFlash is a registered trademark of CompactFlash Association.

SPECIFICATIONS

1. POWER REQUIREMENTS:

Must use Class 2 or SELV rated power supply.
 Power connection via removable three position terminal block.
 Supply Voltage: 12 - 24 VDC, Class 2
 Maximum Power: 200 mA @ 24 VDC
 Fuse: Fast-blow 800mA, 5x20mm

2. BATTERY: Lithium coin cell. Typical lifetime of 10 years.

3. LCD DISPLAY:

SIZE	5.6-inch
TYPE	TFT
COLORS	256
PIXELS	320 X 234
BRIGHTNESS	300 cd/m ²
BACKLIGHT TYPE	LED
BACKLIGHT LIFE	30,000 HR TYP.

4. TOUCHSCREEN: Four-wire resistive analog

5. MEMORY:

On Board User Memory: 2 Mbyte of non-volatile Flash memory.

Memory Card: CompactFlash Type II slot for Type I and Type II CompactFlash cards.

Note: For reliable operation in all of our products, Red Lion recommends the use of SanDisk® and SimpleTech brands of CompactFlash cards. Industrial grade versions that provide up to two million write/erase cycles minimum are available from Red Lion.

6. COMMUNICATIONS: Three Serial Ports - One RS-232 port, two RS-232/422/485: One Ethernet Port

Serial Ports: Format and Baud Rates for each port are individually software programmable up to 115,200 baud.

Ethernet Port: 10 Mbps

7. ENVIRONMENTAL CONDITIONS:

Operating Temperature Range: 0 to 45°C

Operating and Storage Humidity: 10-90% relative humidity (non-condensing) from 0 to 45°C.

Vibration: Operational 10 to 25 Hz, in X, Y, Z direction, 30 minutes, 2 g's.

8. CERTIFICATIONS AND COMPLIANCES:

SAFETY

UL Listed, File #E302106, UL508, CSA-C22.2 No. 142

LISTED by Und. Lab. Inc. to U.S. and Canadian safety standards

UL Type 4 Indoor Use Only Enclosure rating (Face only), UL50

IP65 Enclosure rating (Face only), IEC 529

ELECTROMAGNETIC COMPATIBILITY

Consult factory for EMC specifications

9. CONNECTIONS: Compression cage-clamp terminal block.

Wire Gage: 12-28 AWG copper wire

Communications: DB9 connectors

10.CONSTRUCTION: Plastic enclosure with NEMA 4/IP65 front panel when properly installed.

11. WEIGHT: 30 oz. (850 g)

DIMENSIONS In inches (mm)

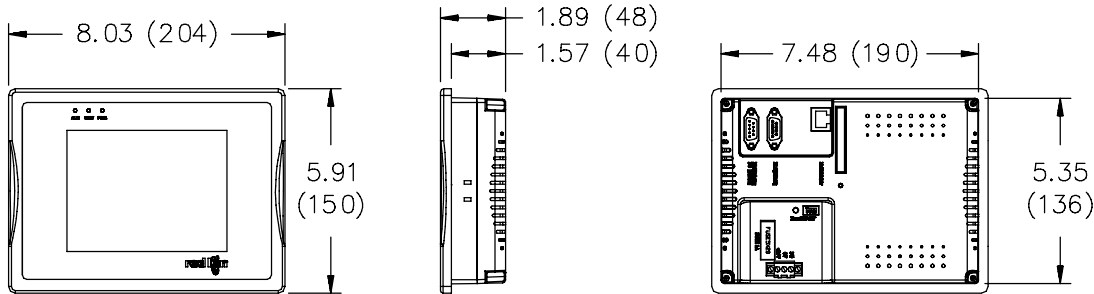

INSTALLING AND POWERING THE G306K

MOUNTING INSTRUCTIONS

The unit can be mounted into enclosures with a depth of 4". It is recommended that the unit be mounted on the front panel of a steel enclosure. Allow clearance of 1" around the sides of the unit for the mounting hardware.

Place the unit in the panel cutout. Slide clamps into the four holes provided at the top and bottom of the case. Tighten the clamping screws in an even pattern until the unit is secured in the panel. Caution: Do not over tighten the clamps. To seal to NEMA4 specifications, all supplied mounting clamps must be used. The panel must not flex more than 0.010".

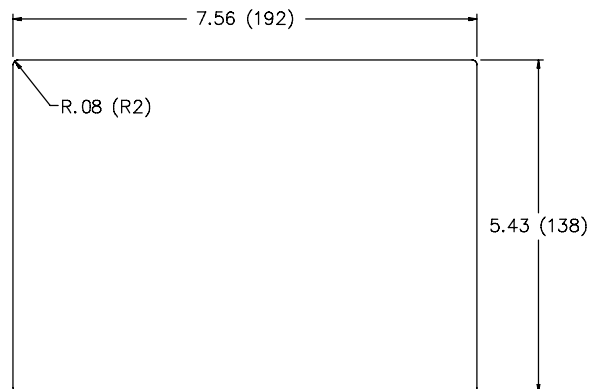

CONNECTING POWER

The G306K requires a 12-24 VDC power supply. Please take care to observe the following points:

- The wire used to connect the operator interface's power supply should be at least 22-gauge wire. If a longer cable run is used, a heavier gage wire should be used. The routing of the cable should be kept away from large contactors, inverters, and other devices which may generate significant electrical noise.
- A power supply with a Class 2 or SELV rating is to be used. A Class 2 or SELV power supply provides isolation to accessible circuits from hazardous voltage levels generated by a mains power supply due to single faults. SELV is an acronym for "safety extra-low voltage." Safety extra-low voltage circuits shall exhibit voltages safe to touch both under normal operating conditions and after a single fault, such as a breakdown of a layer of basic insulation or after the failure of a single component has occurred.

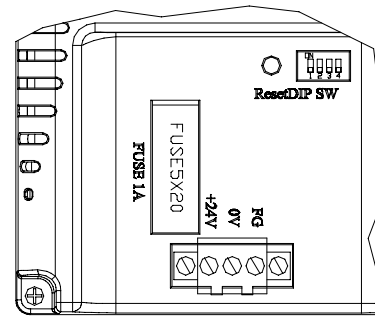

COMMUNICATING WITH THE G306K

The G306K has three serial ports, as well as an Ethernet port. The serial ports are exposed via one DB9 male, and one DB9 female connector. You may assign one unique protocol to each of the Programming, Comms and Auxiliary ports for a total of three different serial protocols.

Note: If you assign a protocol to the Programming Port, you will no longer be able to download. You should create a means to call the StopSystem() function from the HMI touchscreen, such that the Programming Port activity can be halted on command. Alternatively, the HMI's memory can be cleared to restore download functionality.

The Ethernet port can be programmed to communicate via four protocols simultaneously. For more information on protocol support, please refer to the Crimson 2.0 programming software.

COMMS

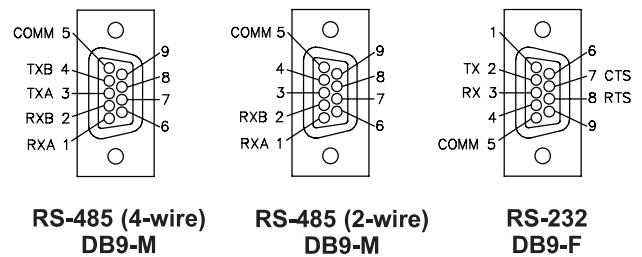

RJ-45 Ethernet

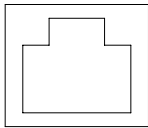

PROGRAMMING

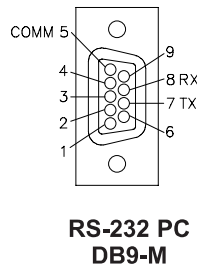

AUXILIARY

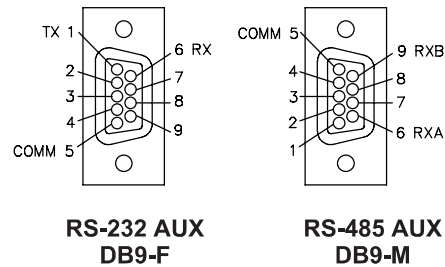

PC CONNECTION

Configuration files are downloaded to the Kadet via the PC port, which can be connected to a computer via various cables.

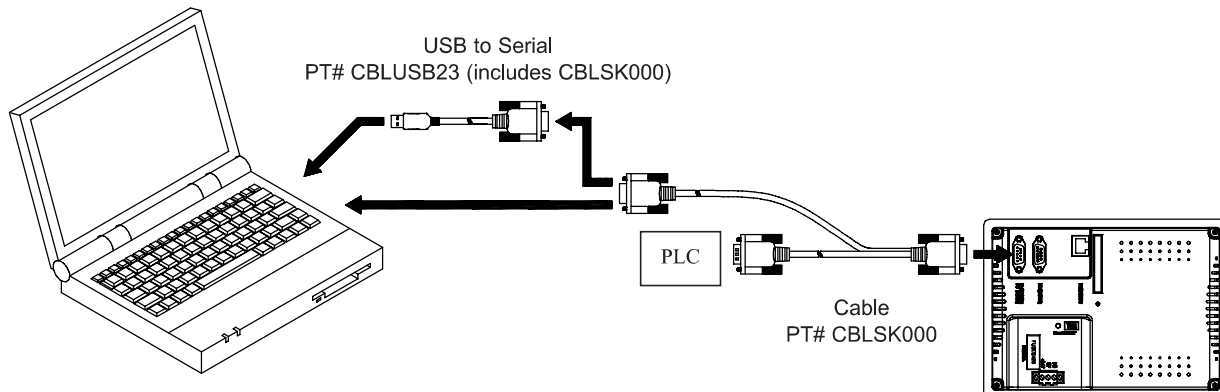

DEVICE COMMUNICATIONS

Several adapters are available which allow direct connection via Red Lion communications cables. For a list of adapters and cables, please visit <http://www.redlion.net/support/downloads.html>.

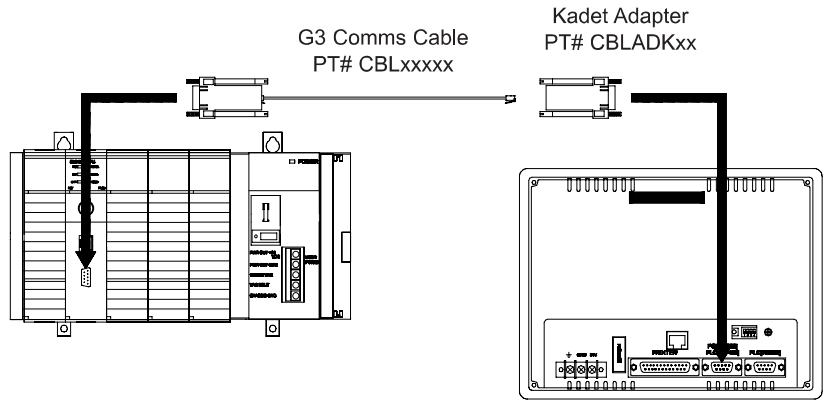

SETTING THE SWITCHES

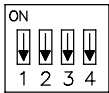

Normal mode.

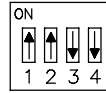

Cycle power with the switches as shown in order to display the Clear Database prompt. Touch the left side of the display to clear the database; touch the right side to continue in normal mode.

SOFTWARE/UNIT OPERATION

CRIMSON SOFTWARE

Crimson software is available as a free download from Red Lion's website or it can be purchased on a CD, see "Ordering Information" for part number. The latest version of the software is always available from the website, and updating your copy is free.

FRONT PANEL LEDs

There are three front panel LEDs. Shown below is the default status of the LEDs.

LED	INDICATION
RED (ALM)	
FLASHING	Tag is in alarm condition and not acknowledged
SOLID	Acknowledged alarms exist
OFF	No alarms present
FLASHES RAPIDLY	In conjunction with Green COM LED when unit is in boot loader
GREEN (COM)	
STEADY	No communications errors are present
OFF	Comms are not established
FLICKERING	Comm error exists
FLASHES RAPIDLY	In conjunction with Red COM LED when unit is in boot loader
ORANGE (PWR)	
STEADY	Power is applied

TOUCHSCREEN

This operator interface utilizes a resistive analog touchscreen for user input. The unit will only produce an audible tone (beep) when a touch on an active touchscreen cell is sensed. The touchscreen is fully functional as soon as the operator interface is initialized, and can be operated with gloved hands.

TROUBLESHOOTING YOUR G306K

If for any reason you have trouble operating, connecting, or simply have questions concerning your new G306K, contact Red Lion's technical support. For contact information, refer to the front page of this bulletin for phone and fax numbers.

EMAIL: techsupport@redlion.net
Web Site: <http://www.redlion.net>

BATTERY REPLACEMENT

The G306K uses one CR2032 coin type lithium battery to maintain the RTC (real-time clock) and for proper Ethernet download operation. To change the battery, remove power, cabling, and then the rear cover of the unit. Remove the old battery from the holder and replace with a new battery*. Replace the rear cover, cables, and re-apply power. Set the RTC to the proper date and time.

* Please note that the old battery must be disposed of in a manner that complies with your local waste regulations. Also, the battery must not be disposed of in fire, or in a manner whereby it may be damaged and its contents come into contact with human skin.



CAUTION: The circuit board contains static sensitive components. Before handling the operator interface without the rear cover attached, discharge static charges from your body by touching a grounded bare metal object. Ideally, handle the operator interface at a static controlled clean workstation. Also, do not touch the surface areas of the circuit board. Dirt, oil, or other contaminants may adversely affect circuit operation.



CAUTION: Danger of explosion if battery is incorrectly replaced. Replace only with the same or equivalent type recommended by the manufacturer. Dispose of used batteries according to the manufacturer's instructions.