

The solid-state 354 is manufactured from a series of computer-tested plug-in circuit boards and assembled virtually without hand wiring. Because it has no moving parts in its logic circuits, its life expectancy is practically unlimited. Even the load relay—the 354's only significant mechanical component—has a life expectancy of 100,000,000 operations (no load), while the optional solid-state switch module has a virtually unlimited life expectancy. As a result, the 354 achieves an overall reliability that surpasses even the high level achieved by previous Shawnee counters.

**CYCLE PROGRESS INDICATION:** The Shawnee 354 indicating counter provides cycle progress indication on a four-digit display located immediately above the digital setting number wheels. While the non-indicating

**EASY TO SET AT ALL TIMES:** The Shawnee counter is easily and accurately set even with work gloves on. Push any of its four toggle levers in any sequence until the number you want appears above it. You can decrease as well as increase each number by pushing the levers up or down. You can change the setting at any time, even during a cycle.

**NOISE IMMUNITY:** The 354 does not have to be shielded: its transformer power supply, full-wave bridges, buffered logic and other design characteristics render it immune to the electrical noise that is sometimes encountered in industrial environments thus eliminating false starts and reset due to voltage spikes.

**PLUG-IN AND DUST-TIGHT:** All 354 counters feature true plug-in design and are dust-tight from the front of panel.

**100% ACCURATE AND BOUNCE-PROOF:** The repeat accuracy of the Shawnee 354 is 100% at all rated speeds, even in the presence of contact bounce. The 354 has two selectable levels of bounce suppression: a normal level which eliminates false counts at speeds up to 500 per second with reed switch inputs, and 5,000 per second with DC voltage pulses; and a high level, for speeds up to 80 per second with high-bounce contact closures (relays, precision switches, etc.).

**HOUSING, IT OCCUPIES 40% LESS:** Packaged in a 72mm<sup>2</sup> DIN size housing, the 354 occupies 40% less panel space than previous IC counters. Modern production and assembly techniques have substantially reduced manufacturing costs resulting in a 45% cost saving.

**CONTROL VERSATILITY:** The 354 operates either as a repeat cycle pulse generator or in single-cycle interval or delayed mode. You choose the kind of control action you want by installing jumpers on the terminal block. It also provides a choice of control output, a standard plug-in SPDT relay or an optional SPST solid-state switch module...plus an independent and separate DC output signal at Terminal 6.

**OPERATION**

The Shawnee 354 operates on a digital logic circuit with three main elements: input circuits which allow it to count various types of DC pulses; a read-only-memory (ROM) whose output is set by the counter's digital setting number wheels; and a comparator that continuously examines the outputs of the input circuit and ROM. When the start (ready/reset) signal is on, the input circuit begins to count incoming pulses, feeding the total count continuously to the comparator. When input circuit output exactly equals ROM output, the 354 counts out. At that instant, the input circuit automatically turns itself off even if the start signal remains on; it is therefore not necessary to turn off the pulses externally. At the same instant, the 354 provides one of three load control actions depending on how it is wired (see Typical Applications). When the 354 is wired for interval operation, the counter's output device (either the standard SPDT relay or the optional SPST switch module) is energized from the start to the end of the count cycle; so is the DC output at terminal 6.



*Shawnee II High Speed Counter*

**MODEL NUMBER**

<b>MODEL NUMBER</b>	354C			30	P	
---------------------	------	--	--	----	---	--

<b>RANGE</b>						
9,999 Counts	350					
99,990 Counts (units digit blind)	353					
Special	000					

<b>VOLTAGE &amp; FREQUENCY</b>						
120 VAC 50-60 Hz			Q			
240 VAC, 50-60 Hz			R			

<b>ARRANGEMENT</b>						
With Display (On-Delay)				30		

<b>FEATURES</b>						
Basic plug-in unit					P	
Standard unit						X
Special						K

<b>ACCESSORIES</b>						
Surface mounting bracket kit						0353-260-27-00
Retrofit kit						0305-265-61-70

**DIMENSIONS (INCHES/MILLIMETERS)**

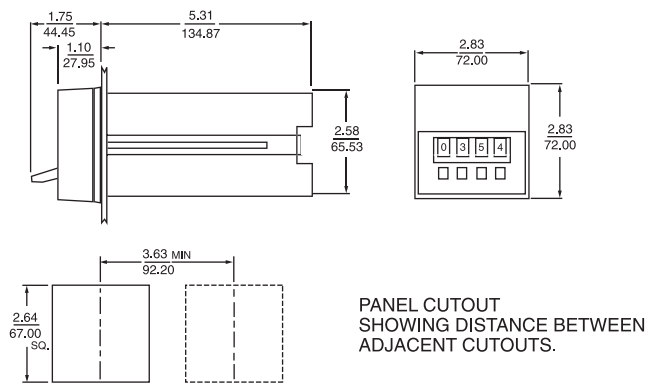

PANEL CUTOUT SHOWING DISTANCE BETWEEN ADJACENT CUTOUTS.

The 354C Directly Replaces 354B & 354A.

**WIRING**

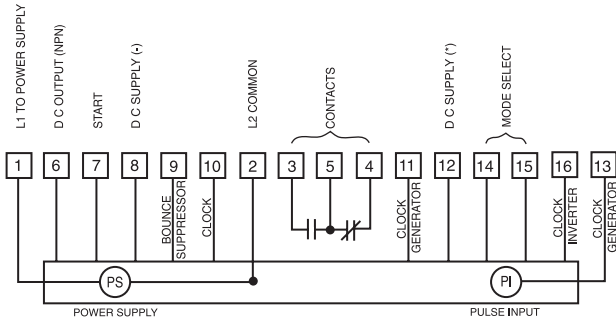

**TERMINAL WIRING  
SOLID STATE  
OUTPUT MODULE**

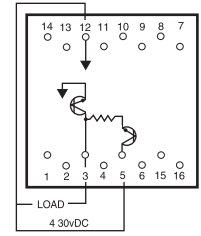
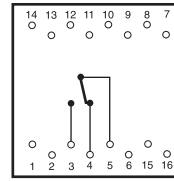

**TYPICAL APPLICATIONS**

The Shawnee 354 has a readily accessible 16-point terminal which allows its use with a variety of start circuits and input pulses and to program it for the desired load action. To wire the 354C so as to suit a particular application is a relatively simple matter that is easily accomplished by selecting one of the examples in each of the following four steps. Combine the four examples for your wiring diagram.

**STEP 1 - START CIRCUITS**

The 354 accommodates three types of start signals. To wire the counter properly to your start signal, first determine which of the three types applies, then consult the appropriate wiring diagram. NOTE: AC line connections are always made to Terminals 1 and 2.

**A. ISOLATED CONTACT** (sustained start signal) The external dry start switch must be closed throughout the count cycle. The 354 is ready to count whenever the switch is closed; it resets when the switch is opened.

**ISOLATED CONTACT  
START—  
(EXTERNAL  
START SWITCH**  
  
\*Jumper for momentary start in interval mode.)

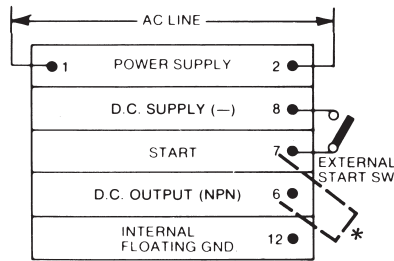

**B. DC VOLTAGE** (sustained start signal) The start voltage must be on throughout the count cycle. The 354 is ready to count whenever the voltage reaches +4.5 or -3V DC; it resets when the voltage drops to +1 or -1V DC.

**DC VOLTAGE START  
(SUSTAINED START)**

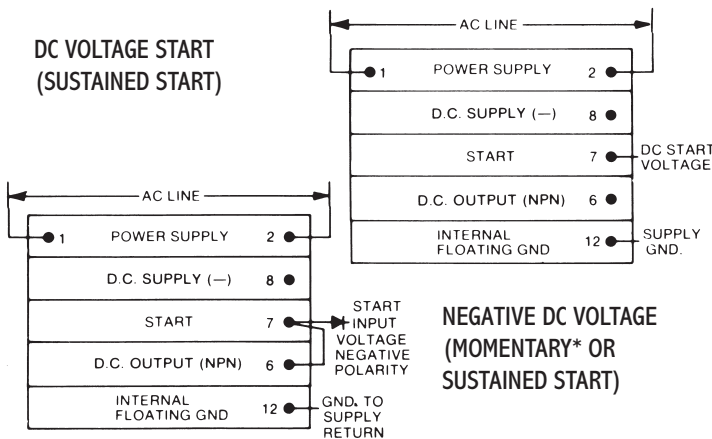

**NEGATIVE DC VOLTAGE  
(MOMENTARY\* OR  
SUSTAINED START)**

**STEP 2 - PROGRAMMING**

The 354 can be used for delayed or interval control or as a repeat cycle pulse generator. Here again, decide which mode you want, then consult the appropriate wiring diagram. Note that the 354 counts on the break of a contact or decrease of a voltage signal when an external jumper is installed between Terminals 12 and 16, as shown in the diagrams in this step. It can also be programmed to count on make simply by leaving the jumper off.

**A. DELAYED MODE.** The SPDT relay provides one delayed closing and one delayed opening circuit, and the 354 generates a DC signal at Terminal 6 at the end of the cycle.

**DELAYED MODE**

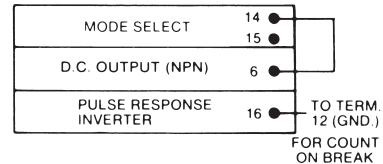

**B. INTERVAL MODE.** The SPDT relay provides one interval opening and one interval closing circuit, and the 354 provides a -24VDC signal at terminal 6 during cycle.

**INTERVAL MODE**

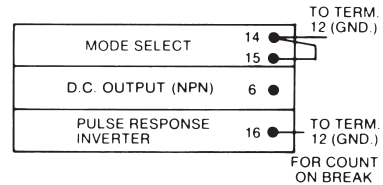

**C. NEGATIVE DC VOLTAGE** (momentary\* or sustained start signal.) The start signal may be momentary or sustained. The 354 is ready to count whenever the start voltage reaches -3V DC. It resets at the end of the cycle, when the start voltage is momentary; or as soon after count-out as the start voltage drops between -1 and 0V DC, when the start signal is sustained.

**D. REPEAT CYCLE PULSE GENERATOR.** In this mode, the 354 generates an output of 80 ms (±20 ms) at the end of the count cycle; the length of the output pulse can be adjusted as follows:

To shorten the pulse, install a fixed or variable resistor between Terminals 12 and 14, sizing it according to this formula:

$$\frac{2.2t - 26.4}{80-t} = R \quad \text{Where: } t = \text{time in ms } (\pm 25\%)$$

$$R = \text{resistance in megohms}$$

To lengthen the pulse, install a capacitor between Terminals 12 and 14 (if a polarized capacitor, install + to 12, - to 14) and size it according to the formula:

$$\frac{T - 0.08}{1.6} = C \quad \text{Where: } T = \text{time in sec } (\pm 25\%)$$

$$C = \text{capacitance in microfarads.}$$

**STEP 3 - PULSE INPUTS**

The 354 can count from low or high-speed contacts or, by virtue of its built-in pulse shaper, from DC voltage pulses of positive or negative polarity. Choose the wiring diagram that suits your application.

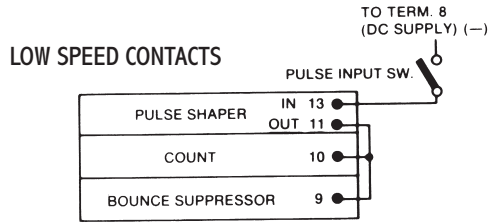

**A. LOW-SPEED CONTACTS.** The 354 counts input pulses from precision switches, relays, limit switches, etc., at speeds up to 80/SEC.

**B. HIGH-SPEED CONTACTS.** Input pulses from low-bounce contacts, reed switches, etc., can be counted at speeds up to 500/SEC. In this circuit only, the 354 counts on the break of the pulse switch as received; to count on make, install a jumper between Terminals 12 and 16; this is the reverse of the situation that applies to all other 354B -

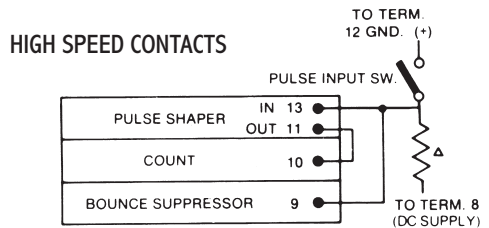

NOTE: With this circuit, to count on break, remove 12-16 jumper, shown in Step 2.  
 ▲ Recommended Value = 33K 1/2 W 10%

**C. DC VOLTAGE PULSES.** In this circuit, the 354 counts when the voltage decreases from above +4.5V to below +1V, or from above -3V to below -1V, with a jumper installed between Terminals 12 and 16 as shown in Section 2; to reverse the action, simply remove the jumper.

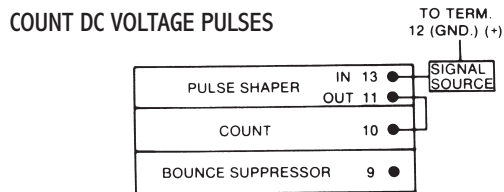

**STEP 4 - LOAD ACTION**

The load action of the 354 depends on the choice of start circuit and programming mode. Loads are always wired to the 354 in the following manner:

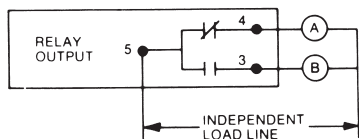

If the 354 is equipped with the optional SPST solid-state switch module, its contacts are always available at Terminals 3 and 5, and its load action is the same as for Load B in the drawings right.

**A. DELAYED MODE.** The load action in this mode is always the same regardless of the kind of start circuit selected in Step 1; but the start signal must remain on during the entire count cycle, as the counter resets when the start signal is removed.

DELAY MODE				
	Before Start	During Timing		End of Cycle
Start SW	Gray	Black	Gray	Reset to Before Start
LOAD A	Gray	Black	Gray	
LOAD B	Gray	Black	Gray	
-241/-27 VDC at Term 6				

**B. INTERVAL MODE WITH SUSTAINED START.** In this mode also, the counter resets when the start signal is removed.

INTERVAL MODE-SUSTAINED START				
	Before Start	During Timing		End of Cycle
Start SW	Gray	Black	Gray	Reset to Before Start
LOAD A	Gray	Black	Gray	
LOAD B	Gray	Black	Gray	
-241/-27 VDC at Term 6				

**C. INTERVAL MODE WITH MOMENTARY START.** Because of the 354's electronic latch capability, it can provide interval control with a momentary negative DC voltage start signal, in which event the 354 resets at the end of cycle. But the counter will also operate with a sustained start signal, in which case it resets when the start signal goes off, as described above.

INTERVAL-MOMENTARY OR SUSTAINED START			
	Before Start	During Timing	End of Cycle
Start SW	Gray	Black	Gray
LOAD A	Gray	Black	Gray
LOAD B	Gray	Black	Gray
-241/-27 VDC at Term 6			

**D. REPEAT CYCLE PULSE GENERATOR.** When this mode is selected, the start signal must remain on continuously. The 354 generates an output pulse at the end of each count cycle, then resets and repeats automatically. At least 500 μs is required for resetting, between the last count of one cycle and the first count of the next. Count pulses can be of unequal length - long and short as shown in the diagram - provided that they meet the minimum requirements listed in the SPECIFICATIONS.

REPEAT CYCLE GENERATOR										
	Before Start	DURING CYCLE								
		C	△	C	△	C	△	C	△	Reset
Start SW	Gray	Black	Black	Black	Black	Black	Black	Black	Black	Reset
LOAD A	Gray	Black	Black	Black	Black	Black	Black	Black	Black	
LOAD B	Gray	Black	Black	Black	Black	Black	Black	Black	Black	
-241/-27 VDC At Term 6										
PULSE SW		Black	Black	Black	Black	Black	Black	Black	Black	

C=COUNT CYCLE=DIAL SETTING      BLACK- CIRCUIT CLOSED  
 △=TIMED PULSE OUTPUT      GRAY- CIRCUIT OPEN

## SPECIFICATIONS

<b>CYCLE PROGRESS INDICATOR</b>	Indicating model only—digit, 0.3 inch, high intensity, blue display	
<b>RANGE</b>	1 to 9999 counts or 10 to 99,990, presettable in 10 count increments.	
<b>PULSE INPUTS</b>	<i>Isolated Contact Input (Dry)</i> Min. Open Resistance 1 megohm Max. Closed Resistance 20K ohms. Switch Requirements 10mA, 30V <i>Count Rate and Bounce Immunity With normal bounce immunity—for Reed Switches (Terminal 9 jumpered to 13)</i> Max. Count Rate 500/SEC Min. Closed Time 100 μSEC Min. Open Time 1 mSEC Max. Open Time for Any Single Bounce 0.3 mSEC <i>Count Rate and Bounce Immunity with maximum bounce immunity—for Precision Switches (Terminal 9 jumpered to 10 and 11)</i> Max. Count Rate 80/ SEC Min. Closed Time 30 μSEC Min. Open Time 6 mSEC Max. Open Time for Any Single Bounce 2.5 mSEC	
<b>VOLTAGE INPUTS</b>	Positive Polarity	On at 4.5V min. Off at 1.0V max
	Negative Polarity	On at 3.0V min. Off at 1.0V max.
	Max. Continuous Input	40V.
	Ripple Voltage	Must not go below min. req.
	Input Impedance	5K ohms
	Min. ON Time	60 μSEC
	Min. OFF Time	100 μSEC
	Count Rate	5K Hz max.
	Rise and Fall Time Req.	none.
<b>DELAYED MODE</b>	Relay Operate Time (after coincidence)	20 mSEC max.
	Relay Release Mode	20 mSEC max.
<b>INTERVAL MODE</b>	Relay Operate Time	15 mSEC max.
	Relay Release Time (after coincidence)	25 mSEC max.
<b>AUTOMATIC RECYCLE MODE</b>	Pulse On time (with relay) 80 mSEC, + 20 mSEC (may be shortened or lengthened by installing a resistor or capacitor, respectively, across Terminals 12 and 14; see Application section for details)	

When the 354 is wired for delayed control, the output device is energized at the end of the cycle and remains on until the counter is reset; so is the DC output.

When the 354 is wired as a repeat cycle pulse generator, the output device and the DC signal are both off until the end of the count cycle, at which time they are both on for about 80 mSEC. From the instant that the output pulse comes on, the 354 stops counting for 500 μSEC while it resets; it automatically begins a new cycle and starts counting pulses again immediately after reset. The duration of the pulse generated by the 354 can be easily lengthened or shortened by wiring a capacitor or resistor across terminals 12 and 14 (see Typical Applications).

<b>START (READY/RESET) SIGNAL</b>	<i>Voltage Requirements</i>	
	Positive Polarity	ready at 4.5V MIN reset at 1.0V max.
	Max. Continuous Input	40V
	Ripple Voltage	must not go below MIN req.
	Input Impedance	5K ohms
	Ready-to-Count Time	0.5 mSEC max (after application of voltage to Terminal 7)
	Circuit Reset	1 mSEC max.
	Ready-To-Dropout	20 mSEC max.
	<i>Start Switch Requirements (isolated contact)</i>	
	Switch Rating	10mA, 30V
	Min. Open Resistance	1 megohm
	Max. Closed Resistance	20K ohms
	<i>Latching Mode Operation (interval only)</i>	
	Min. Duration	50 μSEC
	Start Signal	
	Max. Duration	continuous
	Start Signal	
	Reset	when signal is removed after count-out.

<b>LOAD RELAY</b>	LIFE	100,000,000 operations (no load)
	Contact Rating	5 A at 120 VAC, 3 A at 28 VDC 1/20 HP at 120 VAC 5A @ 120 VAC Resistive, 5A, 30 VDC Resistive

**SOLID-STATE SWITCH MODULE (OPTIONAL)** Switches external DC voltage supply of positive polarity, 4 to 30V, 50 mA max.; factory-wired to Terminals 3 and 5 (detailed description of operation in Installation Instruction)

<b>DC OUTPUT (TERMINAL 6)</b>	Voltage	ON— -24V+10% OFF— -1V or less
	Current	with relay —5mA max. without relay —40mA max.
	Impedance	on— 10 ohms max., off—10K ohms.

<b>DC POWER SUPPLY OUTPUT (TERMINAL 8)</b>	Voltage	24V+10%
	Current	40mA max

<b>POWER REQUIREMENTS</b>	120V	95 to 132V, 50/60 Hz inrush—0. 4A running—0.04A.
	240V	190 to 264V, 50/60 Hz inrush—0.2A running—0.02A.

**TEMPERATURE RATING** 32° to 140°F (0 to 60°C)

<b>MOUNTING</b>	Standard	Hardware is provided to mount counter so that it is dust-tight from front of panel.
	Optional	Surface mounting with front facing terminals

**WEIGHT** NET: 1 lb., 7 oz. SHIPPING: 2 lbs.