

Bracket 45/90

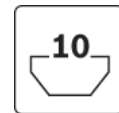

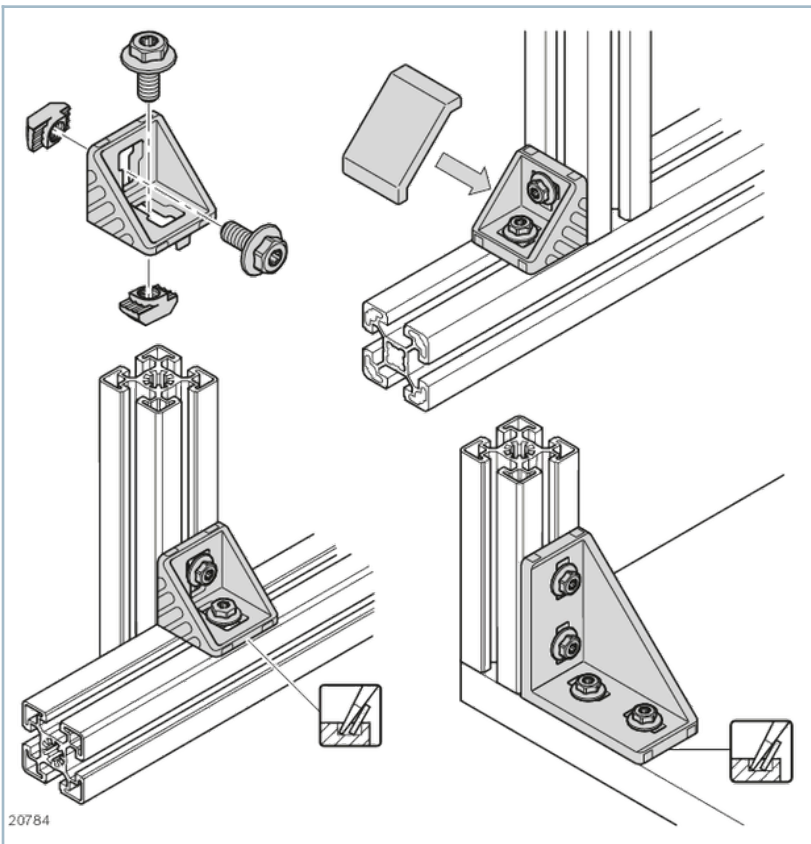

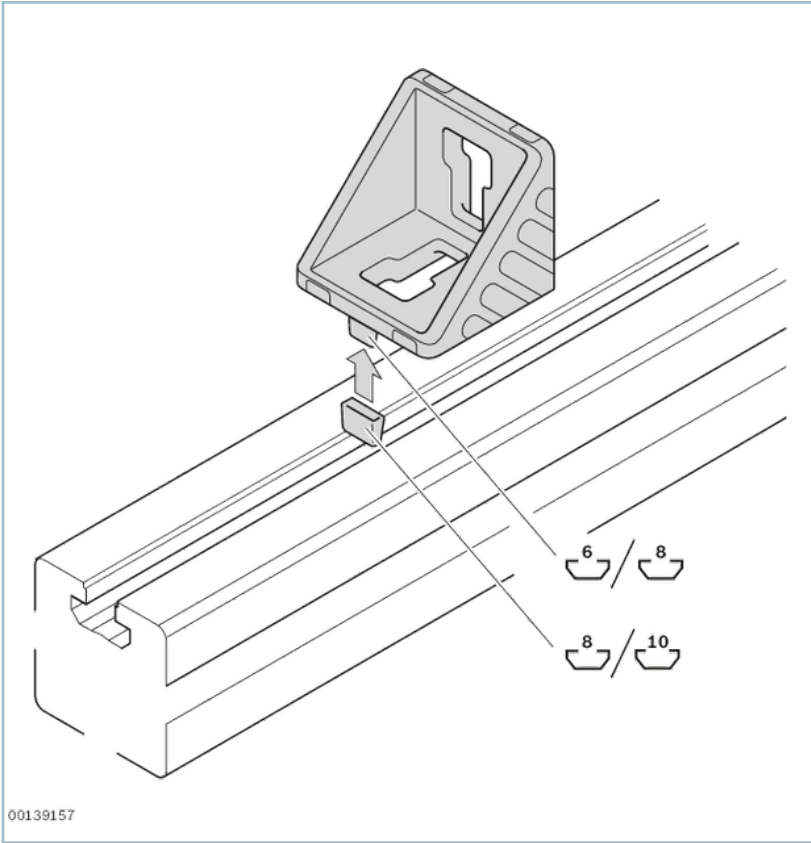

- Brackets with centering lugs for rapid, precise assembly with protection against turning
- Centering lugs can be easily broken off for assembly on plates or at right angles to the slot
- Version *designLINE* with special silver paint (RAL 9006) for an especially high-quality design
- Cover cap to protect from dirt, available in signal gray (RAL 7004) and black ESD (RAL 9005)
- Profile finishing: not required

Product description



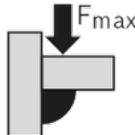
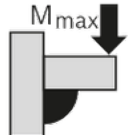
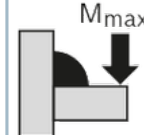

Connection elements, selection criteria

Technical data

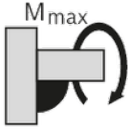
	Groove	ES D	Material entry			
				F_{max}	M_{max}	M_{max}
				N	Nm	Nm
Bracket	10		Bracket: Diecast aluminum, vibratory ground Fastening material: Steel, galvanized	6000	180	400
	10		Bracket <i>designLINE</i> : Diecast aluminum; vibratory ground, painted (RAL 9006) Fastening material: Steel, galvanized	6000	180	400
	10		Bracket: Diecast aluminum, vibratory ground	6000	180	400
Cover cap for bracket			PP			
			PP			

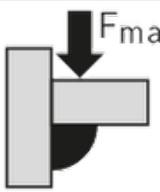
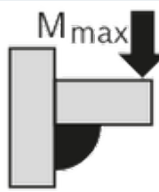
M_{max}
Nm
60
60
60

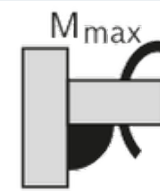
Typ				
45 / 90	6000 N	180 Nm	400 Nm	60 Nm

Dimensions

Bracket 45/90 with cover cap

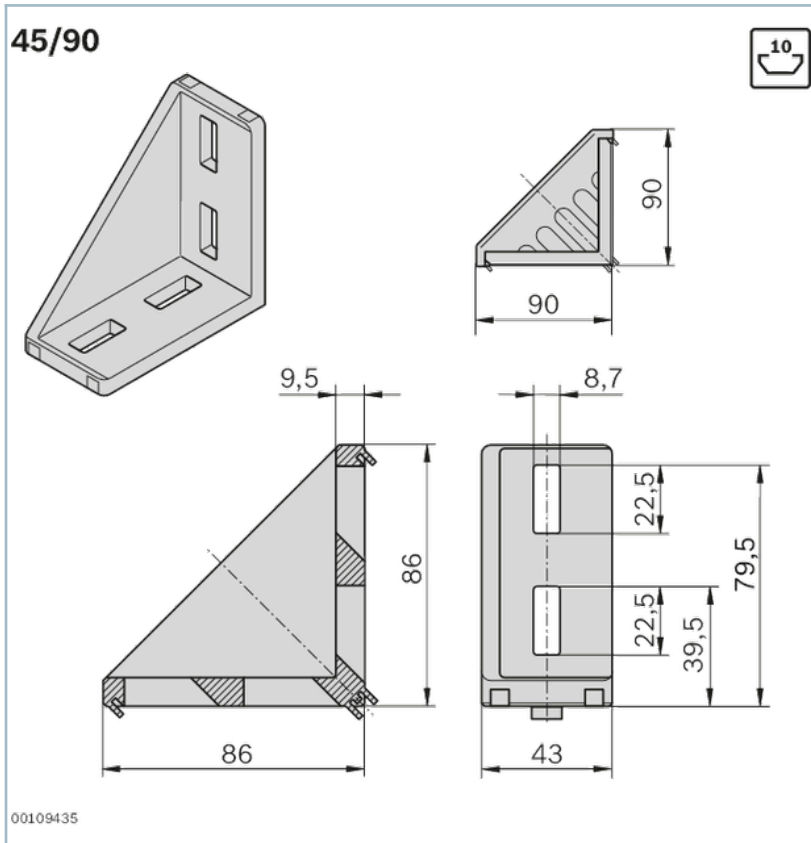

Accessories

Recommended accessories

Cover cap for bracket 45/90, signal gray



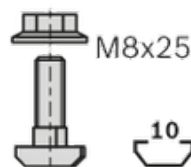

Cover cap for bracket 45/90, black

Delivery notes

FS7



Ordering codes

	Groove		ESD	FS	No.
Bracket 45x90 set (standard)	10			4xFS7	3842523570
Bracket 45x90 set design <i>LINE</i>	10			4xFS7	3842551607
Bracket (standard) 45x90	10	100			3842523567
Cover cap for bracket 45/90, signal gray		20			3842548864
Cover cap for bracket 45/90, black		20			3842548865