

Bracket 90/90

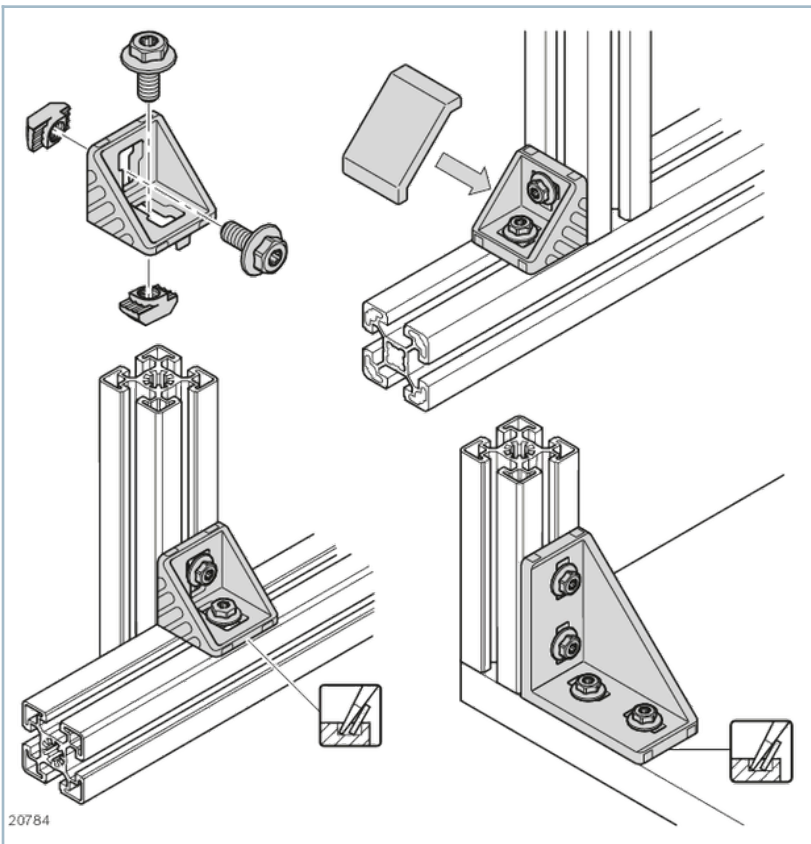

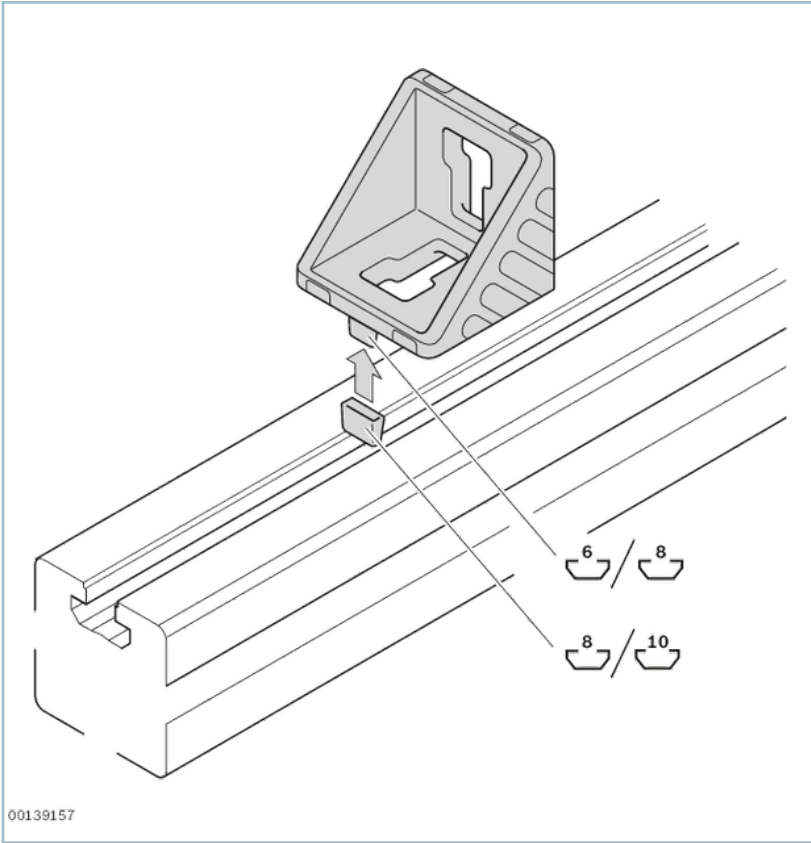



- Brackets with centering lugs for rapid, precise assembly with protection against turning
- Centering lugs can be easily broken off for assembly on plates or at right angles to the slot
- Version *designLINE* with special silver paint (RAL 9006) for an especially high-quality design
- Cover cap to protect from dirt, available in signal gray (RAL 7004) and black ESD (RAL 9005)
- Profile finishing: not required

Product description



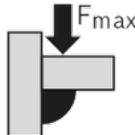
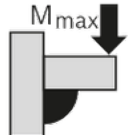
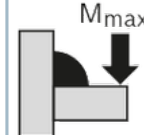

Connection elements, selection criteria

Technical data

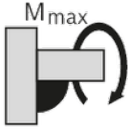
	Groove	ES D	Material entry			
				F_{max}	M_{max}	M_{max}
				N	Nm	Nm
Bracket	10		Bracket: Diecast aluminum, vibratory ground Fastening material: Steel, galvanized	12000	370	800
	10		Bracket <i>designLINE</i> : Diecast aluminum; vibratory ground, painted (RAL 9006) Fastening material: Steel, galvanized	12000	370	800
	10		Bracket: Diecast aluminum, vibratory ground	12000	370	800
Cover cap for bracket			PP			
			PP			

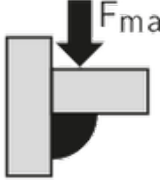
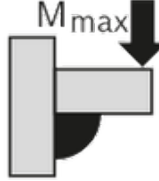
M_{max}
Nm
200
200
200

Typ				
90 / 90	12000 N	370 Nm	800 Nm	200 Nm

Dimensions

Bracket 90/90 with cover cap

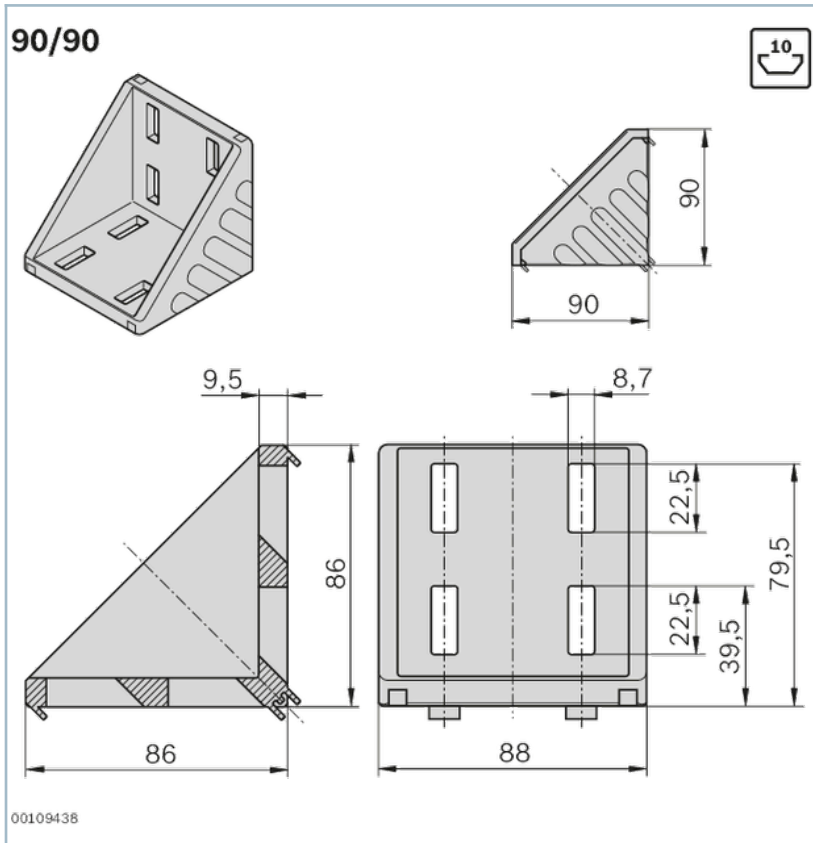

Accessories

Recommended accessories

Cover cap for bracket 90/90, signal gray



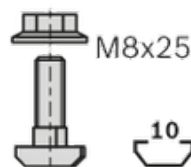

Cover cap for bracket 90/90, black

Delivery notes

FS7



Ordering codes

	Groove		ESD	FS	No.
Bracket 90x90 set (standard)	10			8xFS7	3842523578
Bracket 90x90 set design <i>LINE</i>	10			8xFS7	3842551613
Bracket (standard) 90x90	10	20			3842523575
Cover cap for bracket 90/90, signal gray		20			3842548868
Cover cap for bracket 90/90, black		20			3842548869