

DF-G3 Long Range Expert™ Dual Display Fiber Amplifier



Quick Start Guide

Advanced sensor with dual digital displays for use with plastic and glass fiber optic assemblies; single or dual discrete output models are available.

This guide is designed to help you set up and install the DF-G3 Long Range Expert Dual Display Fiber Amplifier. For complete information on programming, performance, troubleshooting, dimensions, and accessories, please refer to the Instruction Manual at www.bannerengineering.com. Search for p/n 187436 to view the Instruction Manual. Use of this document assumes familiarity with pertinent industry standards and practices.



WARNING:

- **Do not use this device for personnel protection**
- Using this device for personnel protection could result in serious injury or death.
- This device does not include the self-checking redundant circuitry necessary to allow its use in personnel safety applications. A device failure or malfunction can cause either an energized (on) or de-energized (off) output condition.

Overview

Figure 1. DF-G3 Single Output

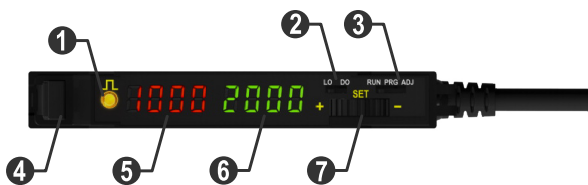
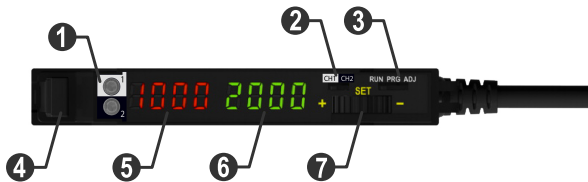

Figure 2. DF-G3 Dual Output



- 1 Single Output LED or Dual Output LEDs
- 2 LO/DO Switch (Single Output) or CH1/CH2 Switch (Dual Output)
- 3 RUN/PRG/ADJ Mode Switch
- 4 Lever Action Fiber Clamp
- 5 Red Signal Level
- 6 Green Threshold
- 7 +/SET/- Rocker Button

Models

Model	Sensing Beam Color	Reference Sensing Range ¹	Outputs	Connector ²
DF-G3-NS-2M	Visible Red	3000 mm	Single NPN	2 m (6.5 ft) cable, 4-wire
DF-G3-PS-2M			Single PNP	
DF-G3-ND-2M			Dual Independent NPN	2 m (6.5 ft) cable, 5-wire
DF-G3-PD-2M			Dual Independent PNP	

¹ Excess gain = 1 (high sensitivity), opposed mode sensing. PIT46U plastic fiber used for visible LED models, IT.83.3ST5M6 glass fiber used for IR models.

² Connector options:

- A model with a QD connector requires a mating cordset
- For 9 m (29.5 ft) cable, change the suffix 2M to 9M in the 2 m model number (DF-G3-NS-9M)
- For 150 mm (6 in) PVC cable with a M8/Pico-style QD model, change the suffix 2M to Q3 in the 2 m model number (DF-G3-NS-Q3)
- For 150 mm (6 in) PVC cable with a M12/Euro-style model, change the suffix 2M to Q5 in the 2 m model number (DF-G3-NS-Q5)
- For integral M8/Pico-style model, change the suffix 2M to Q7 in the 2 m model number (DF-G3-NS-Q7)
- For Q3 and Q7 Dual Output models, use a 5-pin M8/Pico-style or a 6-pin M8/Pico-style mating cordset



Model	Sensing Beam Color	Reference Sensing Range ¹	Outputs	Connector ²
DF-G3IR-NS-2M	Infrared, 850 nm	6000 mm	Single NPN	2 m (6.5 ft) cable, 4-wire
DF-G3IR-PS-2M			Single PNP	
DF-G3IR-ND-2M			Dual Independent NPN	2 m (6.5 ft) cable, 5-wire
DF-G3IR-PD-2M			Dual Independent PNP	
<i>Water Detection Models</i>				
DF-G3LIR-NS-2M	Long infrared, 1450 nm	900 mm	Single NPN	2 m (6.5 ft) cable, 4-wire
DF-G3LIR-PS-2M			Single PNP	
DF-G3LIR-ND-2M			Dual Independent NPN	2 m (6.5 ft) cable, 5-wire
DF-G3LIR-PD-2M			Dual Independent PNP	

Installation Instructions

Mounting Instructions

Mount on a DIN Rail

1. Hook the DIN rail clip on the bottom of the DF-G3 over the edge of the DIN rail (1).
2. Push the DF-G3 up on the DIN rail (1).
3. Pivot the DF-G3 onto the DIN rail, pressing until it snaps into place (2).

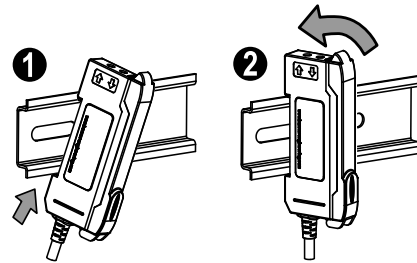

Mount to the Accessory Bracket (SA-DIN-BRACKET)

1. Position the DF-G3 in the SA-DIN-BRACKET.
2. Insert the supplied M3 screws.
3. Tighten the screws.

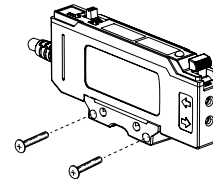

Remove from a DIN rail

1. Push the DF-G3 up on the DIN rail (1).
2. Pivot the DF-G3 away from the DIN rail and remove it (2).

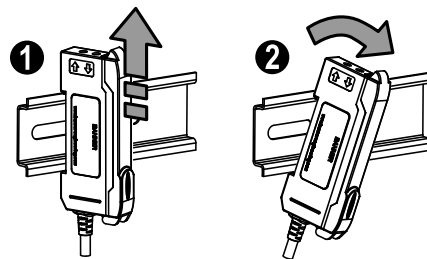

¹ Excess gain = 1 (high sensitivity), opposed mode sensing. PIT46U plastic fiber used for visible LED models, IT.83.3ST5M6 glass fiber used for IR models.

² Connector options:

- A model with a QD connector requires a mating cordset
- For 9 m (29.5 ft) cable, change the suffix 2M to 9M in the 2 m model number (DF-G3-NS-9M)
- For 150 mm (6 in) PVC cable with a M8/Pico-style QD model, change the suffix 2M to Q3 in the 2 m model number (DF-G3-NS-Q3)
- For 150 mm (6 in) PVC cable with a M12/Euro-style model, change the suffix 2M to Q5 in the 2 m model number (DF-G3-NS-Q5)
- For integral M8/Pico-style model, change the suffix 2M to Q7 in the 2 m model number (DF-G3-NS-Q7)
- For Q3 and Q7 Dual Output models, use a 5-pin M8/Pico-style or a 6-pin M8/Pico-style mating cordset

Installing the Fibers in a DF-Gx Sensor

Follow these steps to install glass or plastic fibers.

1. Open the dust cover.
2. Move the fiber clamp forward to unlock it.
3. Insert the fiber(s) into the fiber port(s) until they stop.
4. Move the fiber clamp backward to lock the fiber(s).
5. Close the dust cover.

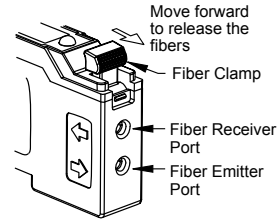

Note: For optimum performance of IR models, if applicable, glass fibers must be used.

Fiber Adapters



Note: If a thin fiber with less than 2.2 mm outer diameter is used, install the fiber adapter provided with the fiber assembly to ensure a reliable fit in the fiber holder. Align the fibers to the end of the adapters. Banner includes the adapters with all fiber assemblies.

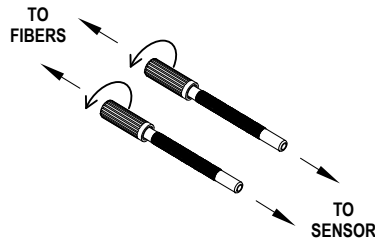

Fiber Outer Diameter (mm)	Adapter Color
Ø 1.0	Black
Ø 1.3	Red
Ø 2.2	No adapter needed

When connecting coaxial-type fiber assemblies to the amplifier, install the single-core (center) fiber to the Transmitter port, and the multi-core (outer) fiber to the Receiver port. This will result in the most reliable detection.

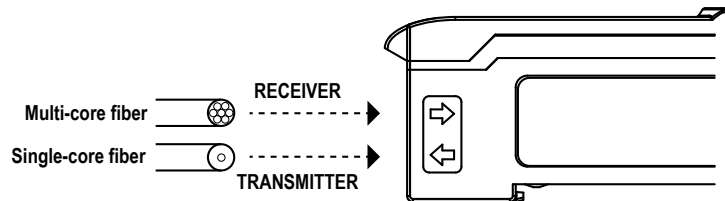

Wiring Diagrams

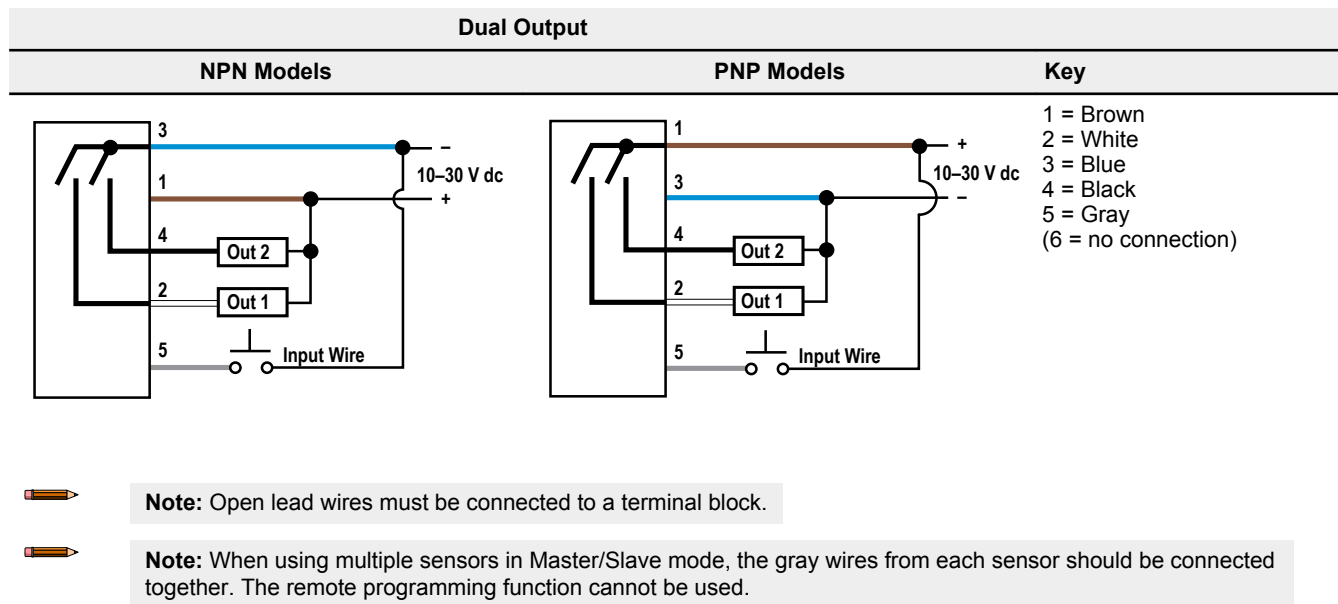
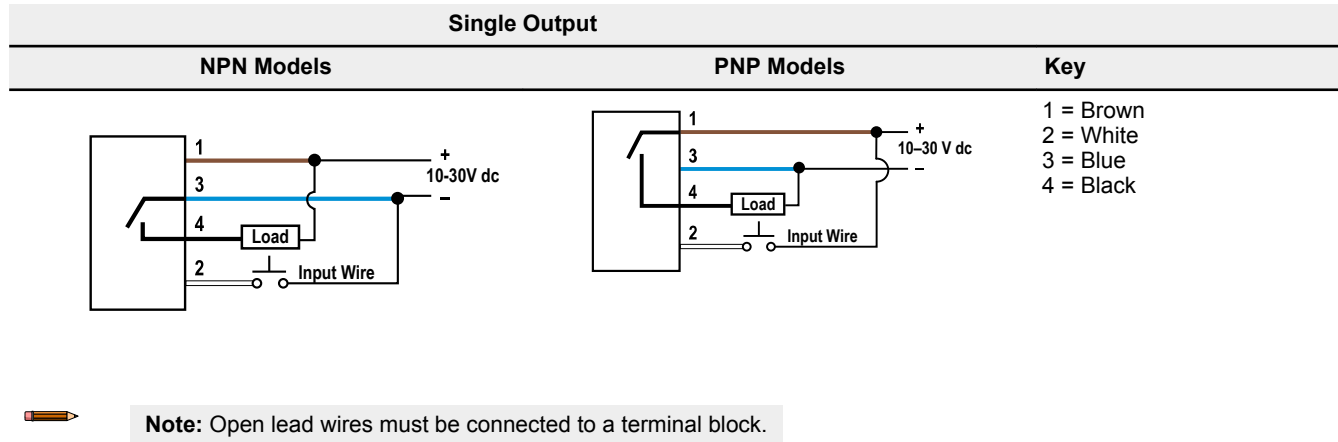

Top Panel Interface

Opening the dust cover provides access to the top panel interface. The top panel interface consists of the RUN/PRG/ADJ mode switch, LO/DO or CH1/CH2 switch, +/SET/- rocker button, dual red/green digital displays, and output LED(s).

**RUN/PRG/ADJ Mode Switch**

The RUN/PRG/ADJ mode switch puts the sensor in RUN, PRG (Program), or ADJ (Adjust) mode.

- RUN mode allows the sensor to operate normally and prevents unintentional programming changes via the +/SET/- rocker button.
- PRG mode allows the sensor to be programmed through the display-driven programming menu (see Program Mode).
- ADJ mode allows the user to perform Expert TEACH/SET methods and Manual Adjust (see [Adjust Mode](#) on p. 7).

**LO/DO Switch (Single Output Models)**

The LO/DO switch selects Light Operate or Dark Operate mode.

- In Light Operate mode, the output is ON when the sensing condition is above the threshold. (For Window SET, the output is ON when the sensing condition is inside the window.)
- In Dark Operate mode, the output is ON when the sensing condition is below the threshold. (For Window SET, the output is ON when the sensing condition is outside the window.)



CH1/CH2 Switch (Dual Output Models)

The CH1/CH2 switch selects which output's parameters can be accessed and changed in the interface of the display.



+/SET/- Rocker Button

The +/SET/- rocker button is a 3-way button. The +/- positions are engaged by rocking the button left/right. The SET position is engaged by clicking down the button while the rocker is in the middle position. All three button positions are used during PRG mode to navigate the display-driven programming menu. During ADJ mode, SET is used to perform TEACH/SET methods and +/- are used to manually adjust the threshold(s). The rocker button is disabled during RUN mode, except when using Window SET (see Window SET).



Red/Green Digital Displays

During RUN and ADJ modes, the Red display shows the signal level, and the Green display shows the threshold or the total counts. During PRG mode, both displays are used to navigate the display-driven programming menu.



Single Output LED

The output LED provides a visible indication when the output is activated.



Dual Output LEDs

The output LEDs provide a visible indication when the associated output is active.

- 1 represents the Channel 1 output.
- 2 represents the Channel 2 output.

Operating Instructions

Remote Input

For more information about how to perform TEACH/SET methods and to program the sensor remotely, see www.bannerengineering.com and search 187436.

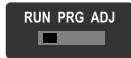

Run Mode

Run mode allows the sensor to operate normally and prevents unintentional programming changes. The +/SET/- rocker button is disabled during RUN mode, except when using Window SET.

Program Mode



Channel 1 Menu

Program (PRG) mode allows the following settings to be programmed in the DF-G3.

CH1 Factory Default Settings:

Out SEL1 (dual only)	LO
tch SEL1	2-pt tch
rESP SPd	2 ms
OFSt Pct1	10 Pct
Auto Thr1	oFF
dLY SEL1	oFF
SEnS SEL1	Std
inPt SEL	oFF
diSP rEAd	diSP 1234
GAin SEL	Auto



Note: The LO/DO selection is not available in the **Single Output** menu.

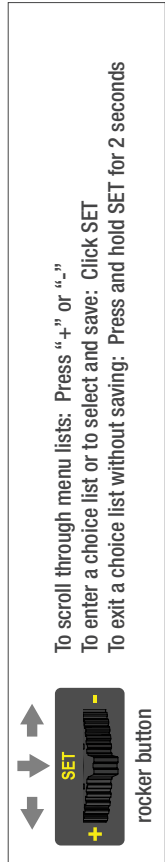

PROGRAM MODE
 Switch Mode to "PRG"



Menu List ↑

Press and hold SET to exit choice list without saving

----- setting-specific -----

* default setting

Out SEL1 Click SET to enter choice list
 + (Loop) -
 LO Do

tch SEL1 Click SET to enter choice list
 + (Loop) -
 2Pt tch d'n tch Wind SET LI SET dr SET CAL SET

rESP SPd Click SET to enter choice list
 + (Loop) -
 500 uS 1000 uS 2 mS 8 mS 24 mS

OFSt Pct1 Click SET to enter choice list
 + (Loop) -
 min Pct 10 Pct (Loop) -
 999 Pct Menu available in LI, dr or wind set only

Auto thr1 Click SET to enter choice list
 + (Loop) -
 oFF on Menu not available when in call set

dLY SEL1 Click SET to enter choice list
 + (Loop) -
 oFF dLay OFF/Sho On/Sho + (Loop) -

SEnS SEL1 Click SET to enter choice list
 + (Loop) -
 Lo Std high

inPt SEL Click SET to enter choice list
 + (Loop) -
 oFF SET MAST SLVE LED oFF LED on Gate

diSP rEAd Click SET to enter choice list
 + (Loop) -
 diSP 1234 diSP 123P Eco 1234 Eco 123P (display flips 180°)
 diSP 1234 diSP 123P Eco 1234 Eco 123P

GAin SEL Click SET to enter choice list
 + (Loop) -
 Auto Fixed Gain Set
 1 2 7

FctY dEF Click SET to enter choice list
 + (Loop) -
 No YES

SLAV Addr Click SET to enter choice list
 + (Loop) -
 1 6

TOtL SLAV Click SET to enter choice list
 + (Loop) -
 1 6

On dLY1 Click SET to enter choice list
 + (Loop) -
 0 mS 9999 mS

OFF dLY1 Click SET to enter choice list
 + (Loop) -
 0 mS 9999 mS

On 1Sh1 Click SET to enter choice list
 + (Loop) -
 1 mS 9999 mS

OFF 1Sh1 Click SET to enter choice list
 + (Loop) -
 1 mS 9999 mS

Click SET to select and save a choice in any list

Return to Menu List

⏪ on display represents a "w" ⏩ on display represents a "m"

RUN PRG ADJ

Channel 2 Menu

Program (PRG) mode allows the following settings to be programmed in the DF-G3.

The LO/DO switch is replaced with the CH1/CH2 selection switch. LO/DO is selected via the **Program Mode** menu. Setting the switch to CH1 allows the settings in the Program Mode chart to be programmed globally for CH1 and CH2.

When CH2 is selected in Program mode, the settings below can be configured for CH2 and are independent from CH1 settings.

CH2 Factory Default Settings:

Out SEL2	LO
tch SEL2	2-pt tch
OFSt Pct2	10 pct
Auto Thr2	oFF
dLY SEL2	oFF
SenS CH2	std

The factory default settings for CH2 and CH1 are the same.

PROGRAM MODE

Switch Mode to "PRG"

RUN PRG ADJ

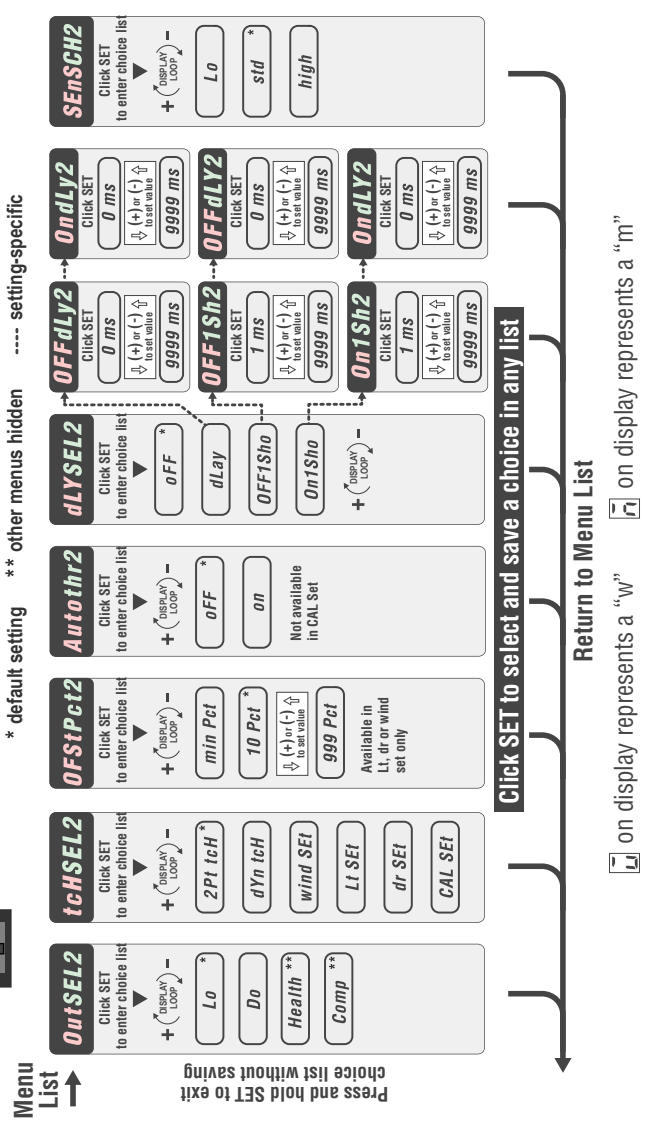
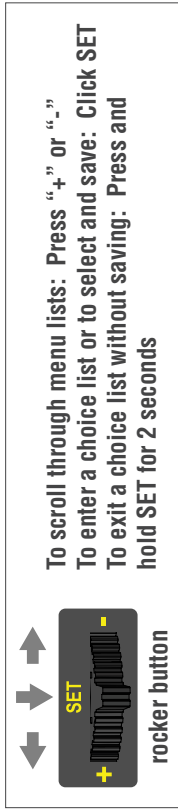

RUN PRG ADJ

Adjust Mode

Sliding the RUN/PRG/ADJ mode switch to the ADJ position allows the user to perform Expert TEACH/SET methods and Manual Adjustment of the threshold(s).

Note: For the Dual Output models, when teaching CH2, the gain setting will be the same as the gain setting made during the CH1 teach. Reteaching CH1 may invalidate the previous CH2 teach.

TEACH Procedures

The instruction manual has detailed instructions for these TEACH modes:

- Two-Point TEACH
- Dynamic TEACH
- Window SET
- Light SET
- Dark SET
- Calibration SET

Two-Point TEACH

- Establishes a single switching threshold
- Threshold can be adjusted by using the "+" and "-" rocker button (Manual Adjust)

Two-Point TEACH is used when two conditions can be presented statically to the sensor. The sensor locates a single sensing threshold (the switch point) midway between the two taught conditions, with the Output ON condition on one side, and the Output OFF condition on the other.

Figure 3. Two-Point TEACH (Light Operate shown)

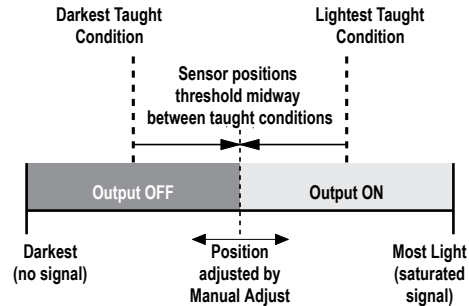

The Output ON and OFF conditions can be reversed by using the LO/DO (Light Operate/ Dark Operate) switch or through the program interface for the dual output model.

Dynamic TEACH

- Teaches on-the-fly
- Establishes a single switching threshold
- Threshold can be adjusted using "+" and "-" rocker button (Manual Adjust)

Dynamic TEACH is best used when a machine or process may not be stopped for teaching. The sensor learns during actual sensing conditions, taking multiple samples of the light and dark conditions and automatically setting the threshold at the optimum level.

Figure 4. Dynamic TEACH (Light Operate shown)

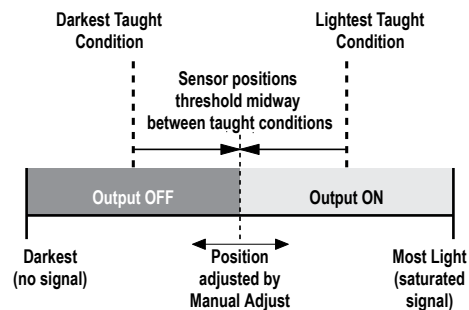

The Output ON and OFF conditions can be reversed by using the LO/DO (Light Operate/ Dark Operate) switch or through the program interface for the dual output model.

Window SET

- Sets window thresholds that extend a programmable % offset above and below the presented condition
- All other conditions (lighter or darker) cause the output to change state
- Sensing window center can be adjusted using "+" and "-" rocker button (Manual Adjust)
- Recommended for applications where a product may not always appear in the same place, or when other signals may appear
- See Program Mode for programming the Offset Percent setting

A single sensing condition is presented, and the sensor positions window thresholds a programmable % offset above and below the presented condition. In LO mode, Window SET designates a sensing window with the Output ON condition inside the window, and the Output OFF conditions outside the window.

Figure 5. Window SET (Light Operate shown)

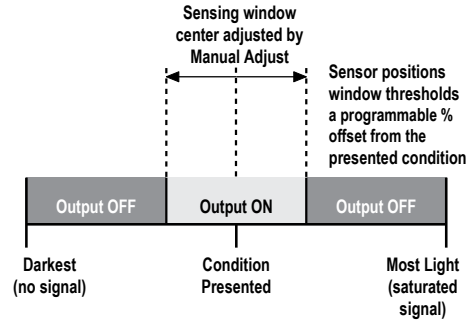

The Output ON and OFF conditions can be reversed by using the LO/DO (Light Operate/ Dark Operate) switch or through the program interface for the dual output model.

Light SET

- Sets a threshold a programmable % offset below the presented condition
- Changes output state on any condition darker than the threshold condition
- Threshold can be adjusted using "+" and "-" rocker button (Manual Adjust)
- Recommended for applications where only one condition is known, for example a stable light background with varying darker targets
- See Program Mode for programming the Offset Percent setting

A single sensing condition is presented, and the sensor positions a threshold a programmable % offset below the presented condition. When a condition darker than the threshold is sensed, the output either turns ON or OFF, depending on the LO/DO setting.

Figure 6. Light SET (Light Operate shown)

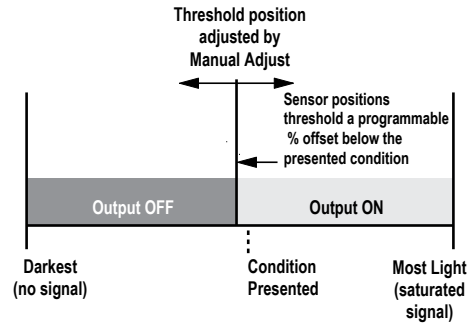

Dark SET

- Sets a threshold a programmable % offset above the presented condition
- Any condition lighter than the threshold condition causes the output to change state
- Threshold can be adjusted using "+" and "-" rocker button (Manual Adjust)
- Recommended for applications where only one condition is known, for example a stable dark background with varying lighter targets
- See Program Mode for programming the Offset Percent setting



Note: Offset Percent MUST be programmed to **Minimum Offset** to accept conditions of no signal (0 counts).

A single sensing condition is presented, and the sensor positions a threshold a programmable % offset above the presented condition. When a condition lighter than the threshold is sensed, the output either turns ON or OFF, depending on the LO/DO setting.

Figure 7. Dark SET (Light Operate shown)

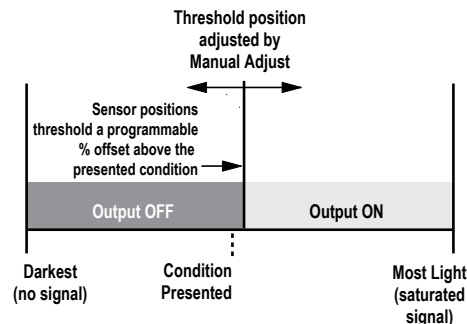

Calibration SET

- Sets a threshold exactly at the presented condition
- Threshold can be adjusted using "+" and "-" rocker button (Manual Adjust)

A single sensing condition is presented, and the sensor positions a threshold exactly at the presented condition. When a condition lighter than the threshold is sensed, the output either turns ON or OFF, depending on the LO/DO setting.

Figure 8. Calibration SET (Light Operate shown)

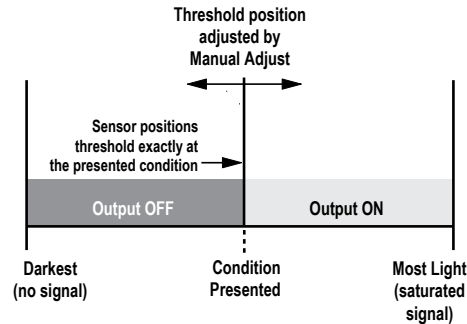

Troubleshooting

Manual Adjustments Disabled

Manual adjustments are disabled when Auto Thresholds are ON. If a manual adjustment is attempted while Auto Thresholds are ON, the Green display will flash Auto.

Percent Minimum Difference after TEACH

The Two-Point and Dynamic TEACH methods will flash a % minimum difference on the displays after a PASS or FAIL.

Value	PASS/FAIL	Description
0 to 99%	FAIL	The difference of the taught conditions does not meet the required minimum
100 to 300%	PASS	The difference of the taught conditions just meets/exceeds the required minimum, minor sensing variables may affect sensing reliability
300 to 600%	PASS	The difference of the taught conditions sufficiently exceeds the required minimum, minor sensing variables will not affect sensing reliability
600% +	PASS	The difference of the taught conditions greatly exceeds the required minimum, very stable operation

Percent Offset after SET

The Window, Dark, and Light SET methods will flash a % offset on the displays after a PASS or FAIL.

SET Result	% Offset Meaning
PASS (with % Offset)	Displays the % offset used for the SET method
FAIL (with % Offset)	Displays the minimum required % offset necessary to PASS the SET method
FAIL (without % Offset)	Presented condition cannot be used for the SET method

Threshold Alert or Threshold Error

Severe contamination/changes in the taught condition can prevent the Auto Thresholds algorithm from optimizing the threshold(s).

State	Display	Description	Corrective Action
Threshold Alert	Alternates Err ALrt and 1234 1234	The threshold(s) cannot be optimized, but the sensor's output will still continue to function	Cleaning/correcting the sensing environment and/or a re-teach of the sensor is highly recommended
Threshold Error	Err Err	The threshold(s) cannot be optimized, and the sensor's output will stop functioning	Cleaning/correcting the sensing environment and/or a re-teach of the sensor is required

Specifications

Sensing Beam

DF-G3: Visible red, 635 nm
 DF-G3IR: Infrared, 850 nm
 DF-G3LIR: Long infrared, 1450 nm

Supply Voltage

10 V DC to 30 V DC Class 2 (10% maximum ripple)

Power and Current Consumption (exclusive of load)

Standard display mode: 840 mW, Current consumption < 35 mA at 24 V DC
ECO display mode: 672 mW, Current consumption < 28 mA at 24 V DC

Supply Protection Circuitry

Protected against reverse polarity, overvoltage, and transient voltages

Delay at Power Up

500 milliseconds maximum; outputs do not conduct during this time

Output Configuration

1 or 2 NPN or PNP outputs, depending on model

Output Rating

100 mA maximum combined load (derate 1 mA per °C above 30 °C)
OFF-state leakage current: < 5 µA at 30 V DC;
ON-state saturation voltage: NPN: < 1.5 V; PNP: < 2 V

Output Protection

Protected against output short-circuit, continuous overload, transient overvoltages, and false pulse on power-up

Response Speed and Features

Description	Response Speed	Repetition Period	Repeatability	Cross-Talk Avoidance	Energy Efficient Light Resistance	Maximum Range, Red ³	Maximum Range, IR850 ⁴
High Speed	500 µs	100 µs	100 µs	No	No	1200 mm	2400 mm
Fast	1000 µs	100 µs	150 µs	Yes	No	1500 mm	3000 mm
Standard	2 ms	100 µs	180 µs	Yes	Yes	1500 mm	3000 mm
Long Range	8 ms	100 µs	180 µs	Yes	Yes	1950 mm	3900 mm
Extra Long Range	24 ms	100 µs	180 µs	Yes	Yes	3000 mm	6000 mm

Operating Conditions

Temperature: -10 °C to +55 °C (+14 °F to +131 °F)
Storage Temperature: -20 °C to +85 °C (-4 °F to +185 °F)
Humidity: 50% at +50 °C maximum relative humidity (non-condensing)

Environmental Rating

IP50, NEMA 1

Connections

PVC-jacketed 2 m or 9 m (6.5 ft or 30 ft) 4-wire or 5-wire integral cable; or integral 4-pin or 5-pin M8 quick disconnect; or 150 mm (6 in) cable with a 4-pin or 5-pin M8 quick disconnect; or 150 mm (6 in) cable with a 4-pin or 5-pin M12 quick disconnect
 For Q3 or Q7 5-pin models, either a 5-pin M8 or a 6-pin M8 mating cordset may be used

Construction

Black ABS/polycarbonate alloy (UL94 V-0 rated) housing, clear polycarbonate cover

Required Overcurrent Protection



WARNING: Electrical connections must be made by qualified personnel in accordance with local and national electrical codes and regulations.

Overcurrent protection is required to be provided by end product application per the supplied table.
 Overcurrent protection may be provided with external fusing or via Current Limiting, Class 2 Power Supply.
 Supply wiring leads < 24 AWG shall not be spliced.
 For additional product support, go to www.bannerengineering.com.

Supply Wiring (AWG)	Required Overcurrent Protection (Amps)
20	5.0
22	3.0
24	2.0
26	1.0
28	0.8
30	0.5

Certifications



Industrial
Control
Equipment
3TJJ

Class 2 power

³ Excess gain = 1 (high sensitivity), opposed mode sensing. PIT46U plastic fiber used for visible LED models.
⁴ Excess gain = 1 (high sensitivity), opposed mode sensing. IT.83.3ST5M6 glass fiber used for IR models.

Banner Engineering Corp. Limited Warranty

Banner Engineering Corp. warrants its products to be free from defects in material and workmanship for one year following the date of shipment. Banner Engineering Corp. will repair or replace, free of charge, any product of its manufacture which, at the time it is returned to the factory, is found to have been defective during the warranty period. This warranty does not cover damage or liability for misuse, abuse, or the improper application or installation of the Banner product.

THIS LIMITED WARRANTY IS EXCLUSIVE AND IN LIEU OF ALL OTHER WARRANTIES WHETHER EXPRESS OR IMPLIED (INCLUDING, WITHOUT LIMITATION, ANY WARRANTY OF MERCHANTABILITY OR FITNESS FOR A PARTICULAR PURPOSE), AND WHETHER ARISING UNDER COURSE OF PERFORMANCE, COURSE OF DEALING OR TRADE USAGE.

This Warranty is exclusive and limited to repair or, at the discretion of Banner Engineering Corp., replacement. **IN NO EVENT SHALL BANNER ENGINEERING CORP. BE LIABLE TO BUYER OR ANY OTHER PERSON OR ENTITY FOR ANY EXTRA COSTS, EXPENSES, LOSSES, LOSS OF PROFITS, OR ANY INCIDENTAL, CONSEQUENTIAL OR SPECIAL DAMAGES RESULTING FROM ANY PRODUCT DEFECT OR FROM THE USE OR INABILITY TO USE THE PRODUCT, WHETHER ARISING IN CONTRACT OR WARRANTY, STATUTE, TORT, STRICT LIABILITY, NEGLIGENCE, OR OTHERWISE.**

Banner Engineering Corp. reserves the right to change, modify or improve the design of the product without assuming any obligations or liabilities relating to any product previously manufactured by Banner Engineering Corp. Any misuse, abuse, or improper application or installation of this product or use of the product for personal protection applications when the product is identified as not intended for such purposes will void the product warranty. Any modifications to this product without prior express approval by Banner Engineering Corp will void the product warranties. All specifications published in this document are subject to change; Banner reserves the right to modify product specifications or update documentation at any time. Specifications and product information in English supersede that which is provided in any other language. For the most recent version of any documentation, refer to: www.bannerengineering.com.

For patent information, see www.bannerengineering.com/patents.