

# MULTI-BEAM® 2-Wire AC Scanner Blocks

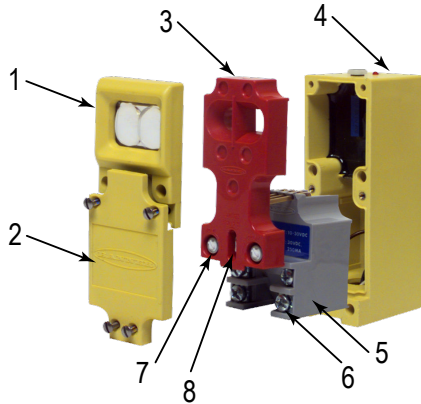

## Datasheet

For MULTI-BEAM modular photoelectric sensors



- 1 = Upper cover (lens), supplied with the scanner block
- 2 = Lower cover, supplied with the scanner block
- 3 = Logic module
- 4 = Scanner block housing
- 5 = Power block
- 6 = Wiring terminals
- 7 = Logic timing adjustment
- 8 = Light/Dark operate select

MULTI-BEAM modular components (scanner block, power block, and logic module) are all purchased separately.





**WARNING:**

- **Do not use this device for personnel protection**
- Using this device for personnel protection could result in serious injury or death.
- This device does not include the self-checking redundant circuitry necessary to allow its use in personnel safety applications. A device failure or malfunction can cause either an energized (on) or de-energized (off) output condition.

## Models

Models	Specifications	Sensing Mode	Description
SBE 2SBR1	<b>Range:</b> 45 m (150 ft) <b>Response:</b> 10 ms on/off <b>Repeatability:</b> 0.03 ms <b>Beam:</b> infrared, 940 nm <b>Effective Beam:</b> 25 mm (1 in) diameter	 OPPOSED	The 2SBR1 receiver model is used with the SBE emitter, the same emitter used with the 1 ms 3- & 4-wire receiver model SBR1. The response time, however, is determined by the receiver, and is 10 ms. This pair will work reliably in slightly dirty (average manufacturing plant) conditions up to 18 m (60 ft) opposed, and outdoors up to 6.1 m (20 ft). When more distance (or excess gain) is required, use 3- & 4-wire receiver model SBRX1 with the SBEX emitter. The 2SBR1 will not work with the visible emitter SBEV. Use opposed mode sensors as a first choice in any application, except where the material to be sensed is translucent to light or so small that it will not break the effective beam diameter. The SBE emitter uses a 3- & 4-wire power block. Power blocks for use with SBE include models PBA-1, PBB-1, PBD-1, PBT-1, and PBT48-1 (see datasheet 03508).
2SBL1	<b>Range:</b> 2.5 cm to 9 m ( 1 in to 30 ft) <b>Response:</b> 10 ms on/off <b>Repeatability:</b> 2.5 ms <b>Beam:</b> infrared, 940 nm	 RETRO	Model 2SBL1 is the retroreflective mode scanner block in the 2-wire MULTI-BEAM family. It has the same excellent optical performance as model SBL1 in the 3- & 4-wire family. If the application calls for breaking a retroreflective beam with shiny objects such as metal cans or cellophane-wrapped packages, mount the 2SBL1 and its retroreflector at an angle of 10 degrees or more to the shiny surface to eliminate an direct reflections from the object itself, or consider using 3- & 4-wire scanner block model SBLVAG1. Alternatively, the MAXI-BEAM, VALU-BEAM, and MINI-BEAM families offer 2-wire AC visible and polarized retroreflective models. The gain falls off at very close sensing ranges, so much so that retroreflectors cannot be used reliably closer than one inch from the sensor.
2SBC1 2SBC1-4	<b>Focus at:</b> 38 mm (1.5 in) <b>Focus at:</b> 10 cm (4 in) <b>Response:</b> 10 ms on/off <b>Repeatability:</b> 2.5 ms <b>Beam:</b> infrared, 940 nm	 CONVERGENT	These convergent mode 2-wire scanner blocks are identical in performance to their 3- & 4-wire equivalents, except for the 10 ms response time. They are designed for 2-wire applications where background objects might be seen by proximity mode sensors, or where the precision of a small focused image is important (for example, edge-guiding or position control). Model 2SBC1 provides much more excess gain at its focus point as compared to the diffuse mode sensors. Convergent mode sensors are preferable to diffuse mode sensors if the distance from the sensor to the object to be detected can be kept constant. Models 2SBC1 and 2SBC1-4 may be derived from retro model 2SBL1 by exchange of the upper cover assembly. Model 2SBC1 uses upper cover UC-C, and model 2SBC1-4 uses upper cover model UC-C4. These may be interchanged. A 152 mm (6 in) convergent model may be created from either model by substituting upper cover UC-C6.

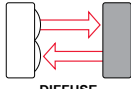

Models	Specifications	Sensing Mode	Description						
2SBD1	<b>Range:</b> 30 cm (12 in) <b>Response:</b> 10 ms on/off <b>Repeatability:</b> 2.5 ms <b>Beam:</b> infrared, 880 nm	 DIFFUSE	Models 2SBD1 and 2SBDX1 diffuse (proximity) mode scanner blocks are identical except for their lenses. Model 2SBD1 uses upper cover model UC-D, and the 2SBDX1 uses UC-L. While the UC-L lens extends the range to over 762 mm (30 in), it creates a dip in the excess gain at closer ranges. As a result, the 2SBDX1 may sense a dark colored object at 254 mm (10 in), but it may not see it at all at 51 mm (2 in). If the application is not completely defined, either scanner block may be ordered, along with the complementary upper cover as an accessory.						
2SBDX1	<b>Range:</b> 76 cm (30 in) <b>Response:</b> 10 ms on/off <b>Repeatability:</b> 2.5 ms <b>Beam:</b> infrared, 880 nm								
2SBF1	<b>Range:</b> see <a href="#">Performance Curves</a> on p. 4 <b>Response:</b> 10 ms on/off <b>Repeatability:</b> 2.5 ms <b>Beam:</b> infrared, 880 nm	 GLASS FIBER	Scanner block 2SBF1 combines the simplicity of 2-wire configuration with the sophistication and versatility of optical fibers. The infrared source of this model will work with any Banner glass fiber optic assembly, except bifurcated assemblies with bundle diameters less than 1.59 mm (1/16 in). Since fibers are frequently used for sensing small parts, fast response time is often a consideration. If the application requires response near the 10 ms specification of the 2SBF1, consider the faster 3- & 4-wire model SBF1. <i>For complete information on glass fiber optic assemblies, see <a href="http://www.bannerengineering.com">www.bannerengineering.com</a>.</i>  The following fiber optic cables and lenses are commonly used with the model 2SBF1 scanner block: <table border="0" style="width: 100%;"> <tr> <td style="vertical-align: top;"> <b>IT13S:</b>                Individual assembly                1.5 mm (0.06 in) diameter fiber bundle             </td> <td style="vertical-align: top;"> <b>L16F:</b>                25 mm (1.0 in) diameter lens             </td> </tr> <tr> <td style="vertical-align: top;"> <b>IT23S:</b>                Individual assembly                3 mm (0.12 in) diameter fiber bundle             </td> <td style="vertical-align: top;"> <b>BT13S:</b>                Bifurcated assembly                1.5 mm (0.06 in) diameter fiber bundles             </td> </tr> <tr> <td style="vertical-align: top;"> <b>L9:</b>                12 mm (0.5 in) diameter lens             </td> <td style="vertical-align: top;"> <b>BT23S:</b>                Bifurcated assembly                3 mm (0.12 in) diameter fiber bundles             </td> </tr> </table>	<b>IT13S:</b> Individual assembly 1.5 mm (0.06 in) diameter fiber bundle	<b>L16F:</b> 25 mm (1.0 in) diameter lens	<b>IT23S:</b> Individual assembly 3 mm (0.12 in) diameter fiber bundle	<b>BT13S:</b> Bifurcated assembly 1.5 mm (0.06 in) diameter fiber bundles	<b>L9:</b> 12 mm (0.5 in) diameter lens	<b>BT23S:</b> Bifurcated assembly 3 mm (0.12 in) diameter fiber bundles
<b>IT13S:</b> Individual assembly 1.5 mm (0.06 in) diameter fiber bundle	<b>L16F:</b> 25 mm (1.0 in) diameter lens								
<b>IT23S:</b> Individual assembly 3 mm (0.12 in) diameter fiber bundle	<b>BT13S:</b> Bifurcated assembly 1.5 mm (0.06 in) diameter fiber bundles								
<b>L9:</b> 12 mm (0.5 in) diameter lens	<b>BT23S:</b> Bifurcated assembly 3 mm (0.12 in) diameter fiber bundles								

## Overview

A Banner MULTI-BEAM Sensor is a compact modular self-contained photoelectric switch consisting of three components: a scanner block, a power block, and a logic module.

The **scanner** block comprises the housing for the sensor and contains a complete modulated photoelectric amplifier, the emitter and receiver optoelements and lenses, and space for the other modules.

The **power** block module provides the interface between the scanner block and the external circuit. It contains a power supply for the MULTI-BEAM plus a switching device (except in emitter-only power blocks) to interface the sensor to the circuit to be controlled.

The **logic** module interconnects the power block and scanner block both electrically and mechanically. It provides the desired timing logic function (if any) plus the ability to program the output for either light- or dark-operate.

The emitters of MULTI-BEAM opposed mode emitter/receiver pairs do not require a logic module. Emitter scanner blocks are supplied with a blade-pin to interconnect the scanner block and power block. Power block and logic modules are purchased separately. This modular design, with field-replaceable power block and logic modules, permits a large variety of sensor configurations, resulting in exactly the right sensor for any photoelectric application.

## Scanner Blocks

MULTI-BEAM 2-wire sensors connect in series with an AC load, exactly like a heavy-duty limit switch. Models are offered in all sensing modes, including glass fiber optic. All have 10 ms on-off response time and built-in protection against false pulse on power-up.

The circuitry of all MULTI-BEAM components is encapsulated within rugged, corrosion resistant PBT polyester housings that meet or exceed NEMA 1, 3, 12, and 13 ratings. MULTI-BEAM 2-wire scanner blocks include Banner's exclusive, patented Alignment Indicating Device (AID™) system, which lights a top-mounted LED when the sensor sees its modulated light source and pulses at a rate proportional to the strength of the received light signal.

## Installation

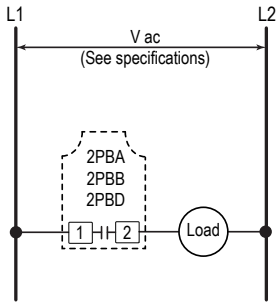

Figure 1. Basic Wiring of 2-Wire MULTI-BEAM

MULTI-BEAM 2-wire sensors wire in series with an appropriate load. This combination, in turn, wires directly across the ac line. A 2-wire sensor may be connected exactly like a mechanical limit switch.

The MULTI-BEAM remains powered when the load is off by a residual current that flows through the load. This off-state leakage current is always less than 1 mA. The effect of this leakage current depends upon the characteristics of the load. The voltage that appears across the load in the off-state is equal to the leakage current of the sensor multiplied by the resistance of the load:  $V_{off} = 1 \text{ mA} \times R_{load}$ .

If this resultant off-state voltage is less than the guaranteed turn-off voltage of the load, the interface is direct. If the off-state voltage causes the load to stay on, connect an artificial load resistor in parallel with the load to lower its effective resistance. Most loads, including most programmable logic controller (PLC) inputs, will interface to 2-wire sensors with 1 mA leakage current without needing an artificial load resistor. There is no polarity requirement. Either wire may connect to terminal #1 and the other to terminal #2.



**CAUTION:** All three components of a MULTI-BEAM 2-wire sensor will be destroyed if the load becomes a short circuit.

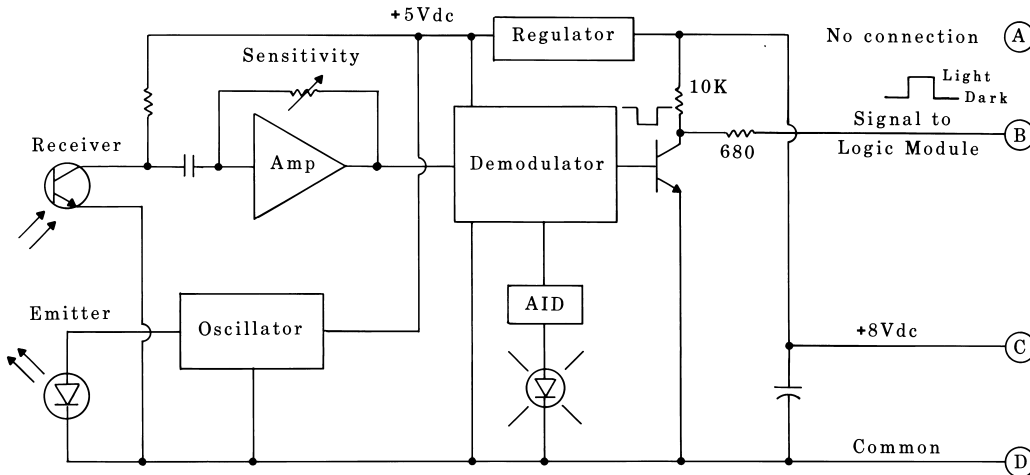

Figure 2. Functional Schematic

## Specifications

### Supply Voltage

Connections are made via a 2-wire power block (see product data sheet P/N 03508).

### Response Time

10 ms ON and OFF (3000 operations per minute).



**Note:** Built-in false pulse protection circuit holds output off for 100 ms after power is initially applied.



**Note:** Response/repeatability specifications are independent of signal strength.

### Certifications



### Sensitivity Adjustment

Easily accessible, located on top of scanner block beneath o-ring gasketed screw cover. 15-turn clutched control (rotate clockwise with a small screwdriver to increase gain).

### Repeatability of Response

See individual sensor specifications.

### Alignment Indicator

Red LED on top of scanner block. Banner's Alignment Indicating Device (AID™) circuit lights the LED whenever the sensor detects its own modulated light source, and pulses the LED at a rate proportional to the received light level.

### Construction

Reinforced PBT polyester housing with components totally encapsulated. Stainless steel hardware. Meets NEMA standards 1, 3, 12, 13.

### Storage Temperature

-40 °C to +70 °C (-40 °F to +158 °F)

## Dimensions

All measurements are listed in millimeters [inches], unless noted otherwise.

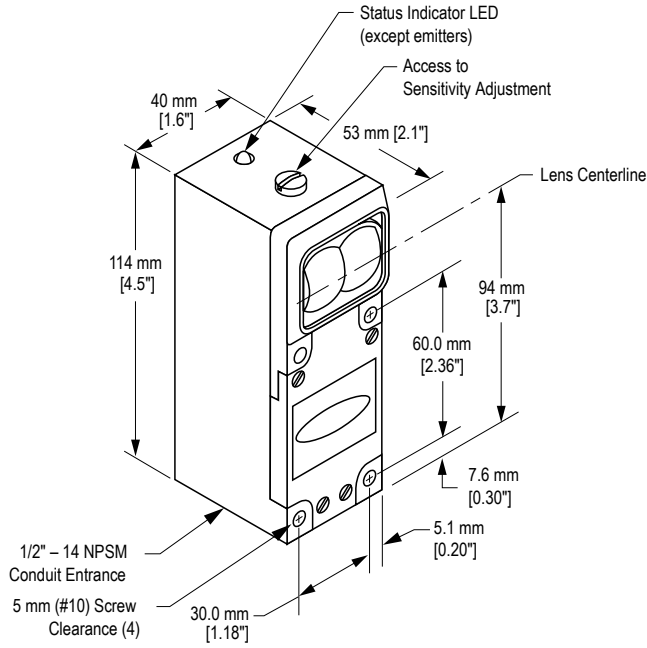

## Performance Curves

### Opposed

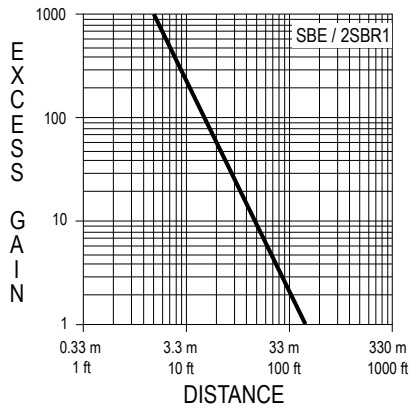

Figure 3. Excess Gain

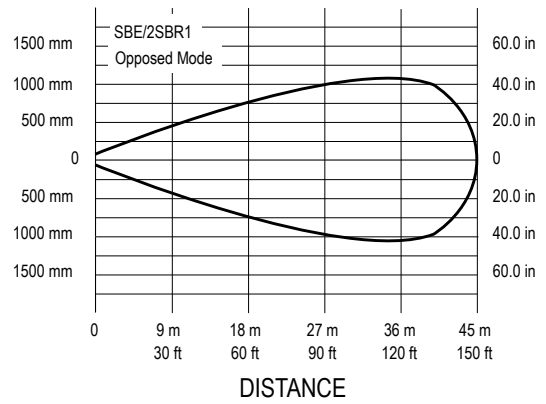

Figure 4. Beam Pattern

**Retroreflective**

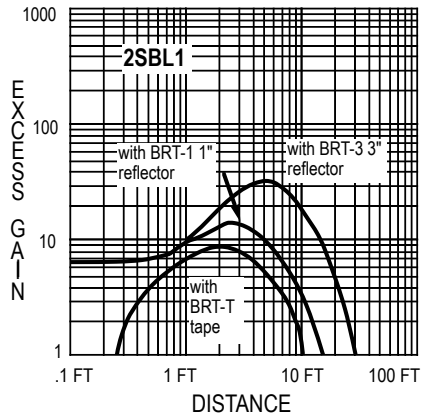

Figure 5. Excess Gain

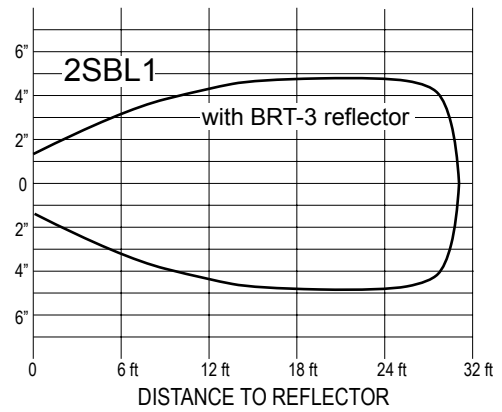

Figure 6. Beam Pattern

**Convergent**

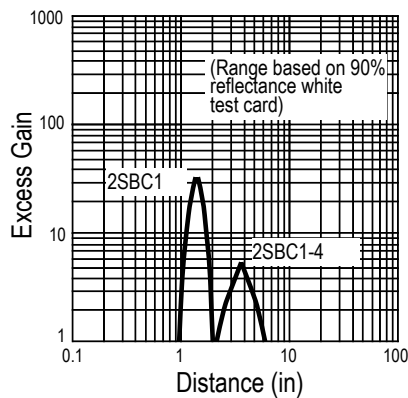

Figure 7. Excess Gain

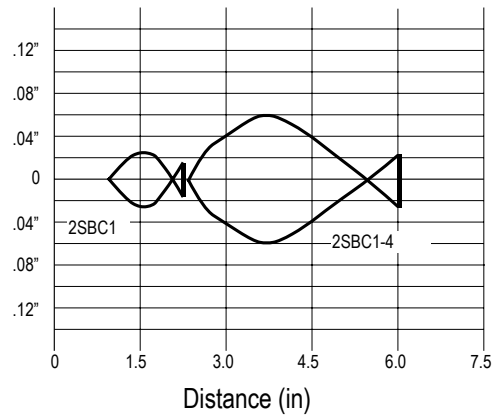

Figure 8. Beam Pattern

**Diffuse**

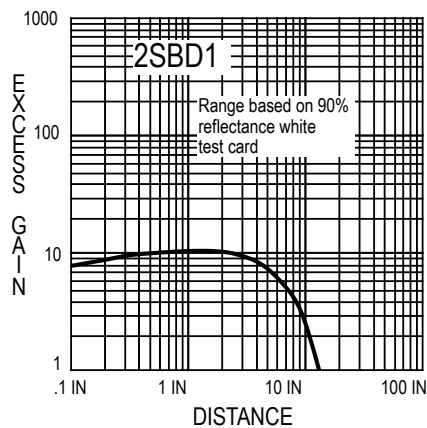

Figure 9. Excess Gain

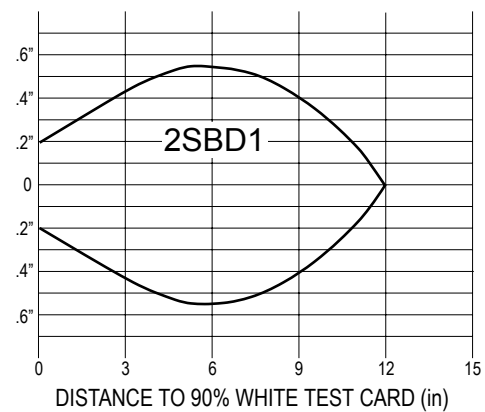

Figure 10. Beam Pattern

Diffuse

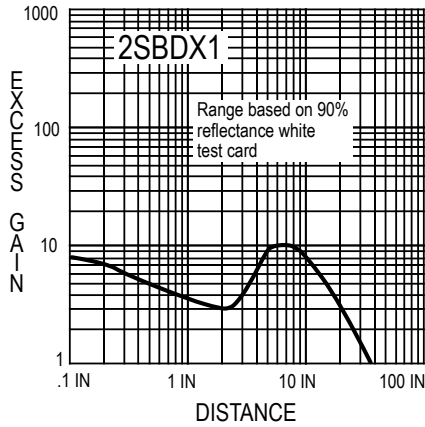

Figure 11. Excess Gain

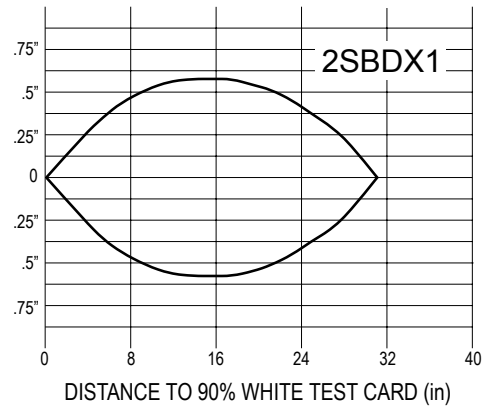

Figure 12. Beam Pattern

Fiber Optic (glass fibers)

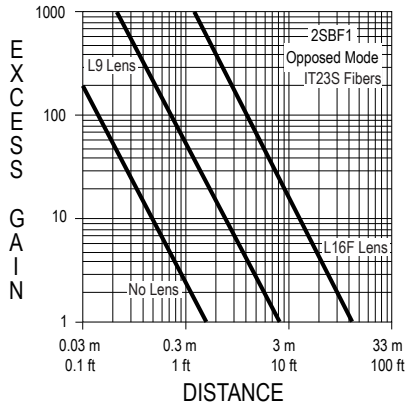

Figure 13. Excess Gain - Opposed

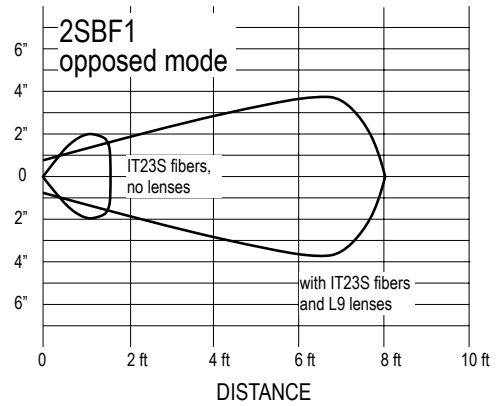

Figure 14. Beam Pattern - Opposed

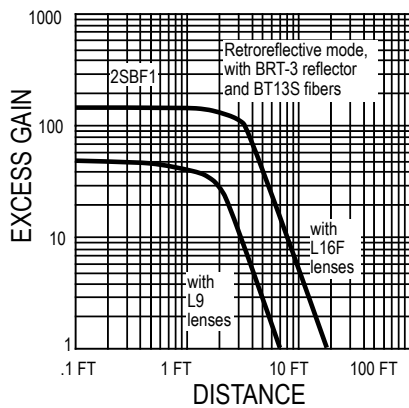

Figure 15. Excess Gain - Retroreflective

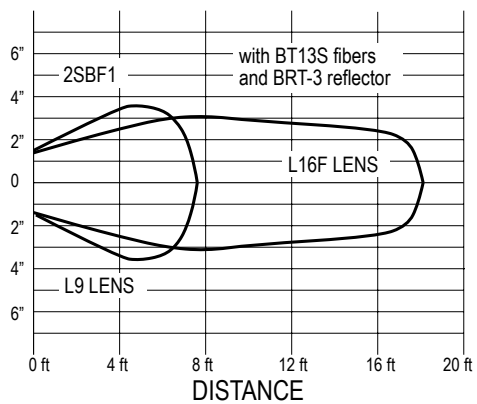

Figure 16. Beam Pattern - Retroreflective

**Fiber Optic (glass fibers)**

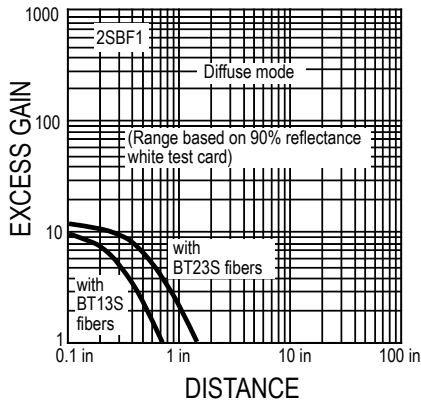

Figure 17. Excess Gain - Diffuse

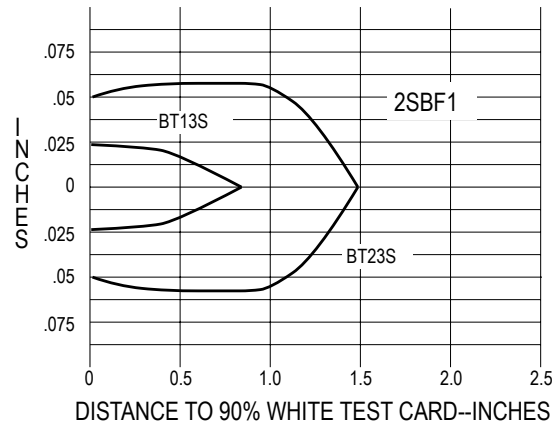

Figure 18. Beam Pattern - Diffuse

## Troubleshooting

Symptom	Probable Cause	Correction
Alignment indicator never comes on, and output never switches the load.	Sensitivity is too low.	Turn Sensitivity control clockwise to increase gain.
	Loose connection.	Check wiring and connections to load.
	Failure of a sensor component.	Test MULTI-BEAM using Banner model LMT. Replace failed module.
	Broken or obscured lens(es) or fiber optic assembly.	Clean or replace upper cover assembly (or fiber optic assembly).
	Opposed Mode: Emitter and receiver misaligned.	Realign using AID™ signal strength indicator.
	Retroreflective Mode: Retro target is outside 2SBL1's field of view.	Realign using AID™ signal strength indicator.
	Diffuse or Convergent Mode: Object to be sensed is outside MULTI-BEAM's field of view.	Realign to the object using AID™ signal strength indicator.
Alignment indicator never comes on, but output does switch load correctly.	Fiber Optic Modes: Fiber bundle diameter is too small for required range.	Use fiber optic assembly with larger bundle size.
	Broken alignment indicator LED (sensor will continue to operate).	Replace scanner block (if alignment indicator is required).
Alignment indicator is always on, and output never switches load.	MULTI-BEAM is responding to noise.	Use Banner model BT-1 BEAM TRACKER to locate the noise source.
	Failure of sensor component.	Test MULTI-BEAM using Banner LMT. Replace failed module.
	Opposed Mode: Burnthrough is occurring.	Reduce gain by: turning receiver Sensitivity control counter-clockwise, intentional misalignment, and/or adding lens aperture on emitter and/or receiver.
	Object is too small to break the effective beam.	Add lens aperture to shape the effective beam to match the profile of object.
	Retroreflective Mode: False light returned by the object as it passes through the sensing beam.	Turn Sensitivity control counter-clockwise to decrease gain. Angle the sensor if background is shiny.
	Diffuse or Convergent Mode: False light returned from background object.	Turn Sensitivity control counter-clockwise to decrease gain. Angle the sensor if background is shiny. Use model with shorter range.
	Optical crosstalk from the broken lens.	Turn Sensitivity control counter-clockwise to decrease gain. Replace the upper cover assembly (see <a href="http://www.bannerengineering.com">www.bannerengineering.com</a> ).

Symptom	Probable Cause	Correction
	Fiber Optic Mode: <ul style="list-style-type: none"> <li>Bifurcated fiber assembly: Optical crosstalk from broken fibers inside the bifurcated assembly. See Diffuse or Retroreflective mode in <a href="#">Performance Curves</a> on p. 4.</li> <li>Individual assemblies: See Opposed mode in <a href="#">Performance Curves</a> on p. 4.</li> </ul>	Replace the fiber optic assembly.
Alignment indicator follows sensing action normally, but output never energizes.	Failure of logic module or power block.	Test MULTI-BEAM using Banner model LMT. Replace failed module.
Sensitivity control cannot be set to sense the difference between the light and dark conditions. The sensitivity is either too high or too low.	Opposed Mode: Burnthrough is occurring. Object is too small to break the effective beam.	Evaluate alternative sensing methods. Add lens apertures to shape the effective beam to match the profile of the object.
	Retroreflective Mode: Object is too transparent. Object is too reflective.	Evaluate alternative sensing methods. Angle the sensor to object's shiny surface.
	Diffuse or Convergent Modes: False light is being returned from background object(s).	Increase difference in reflectivity between the light and dark conditions (for example, drill a hole through the background). Evaluate alternative sensing methods.

## Banner Engineering Corp Limited Warranty

Banner Engineering Corp. warrants its products to be free from defects in material and workmanship for one year following the date of shipment. Banner Engineering Corp. will repair or replace, free of charge, any product of its manufacture which, at the time it is returned to the factory, is found to have been defective during the warranty period. This warranty does not cover damage or liability for misuse, abuse, or the improper application or installation of the Banner product.

**THIS LIMITED WARRANTY IS EXCLUSIVE AND IN LIEU OF ALL OTHER WARRANTIES WHETHER EXPRESS OR IMPLIED (INCLUDING, WITHOUT LIMITATION, ANY WARRANTY OF MERCHANTABILITY OR FITNESS FOR A PARTICULAR PURPOSE), AND WHETHER ARISING UNDER COURSE OF PERFORMANCE, COURSE OF DEALING OR TRADE USAGE.**

This Warranty is exclusive and limited to repair or, at the discretion of Banner Engineering Corp., replacement. **IN NO EVENT SHALL BANNER ENGINEERING CORP. BE LIABLE TO BUYER OR ANY OTHER PERSON OR ENTITY FOR ANY EXTRA COSTS, EXPENSES, LOSSES, LOSS OF PROFITS, OR ANY INCIDENTAL, CONSEQUENTIAL OR SPECIAL DAMAGES RESULTING FROM ANY PRODUCT DEFECT OR FROM THE USE OR INABILITY TO USE THE PRODUCT, WHETHER ARISING IN CONTRACT OR WARRANTY, STATUTE, TORT, STRICT LIABILITY, NEGLIGENCE, OR OTHERWISE.**

Banner Engineering Corp. reserves the right to change, modify or improve the design of the product without assuming any obligations or liabilities relating to any product previously manufactured by Banner Engineering Corp. Any misuse, abuse, or improper application or installation of this product or use of the product for personal protection applications when the product is identified as not intended for such purposes will void the product warranty. Any modifications to this product without prior express approval by Banner Engineering Corp will void the product warranties. All specifications published in this document are subject to change; Banner reserves the right to modify product specifications or update documentation at any time. Specifications and product information in English supersede that which is provided in any other language. For the most recent version of any documentation, refer to: [www.bannerengineering.com](http://www.bannerengineering.com).

For patent information, see [www.bannerengineering.com/patents](http://www.bannerengineering.com/patents).



more sensors, more solutions