

# Sure Cross® Wireless Q45UA All-in-One Ultrasonic Node



## Datasheet

Sure Cross® Wireless Q45 Sensors combine the best of Banner's flexible Q45 sensor family with its reliable, field-proven, Sure Cross wireless architecture to solve new classes of applications limited only by the user's imagination. Containing a variety of sensor models, a radio, and internal battery supply, this product line is truly plug and play.

The Q45UA combines the functionality of a K50U ultrasonic sensor with the reliability of the Q45 Wireless Node into one compact package, eliminating the need for ordering multiple components and reducing the physical size of the device. This solution allows monitoring of fluid or dry assets in remote locations without human intervention. The industrial grade, battery-powered device can be used to wirelessly transmit level or position to a wireless controller/gateway for remote monitoring or control with local LED indication. All configuration is done through internal DIP switches or the User Configuration Software. In addition, caustic chemical resistant versions are available.

### Benefits

- Provides for ability to deliver factory automation and IIoT solutions for many applications including but not limited to:
  - Supply tank level
  - Remote fuel tank level
  - Epoxy/chemical totes or containers
  - 55 gallon drum level
  - Dry goods bin fill level
  - Presence and absence
  - Holding tank levels
- Prevent tank overfills and pump cavitation by providing level status and alarming capabilities
- Battery powered for "peel and stick" functionality with a two-year battery life capability
- Easy-to-use/rugged device that can be mounted permanently to equipment or temporarily threaded into bung holes of supply tanks.

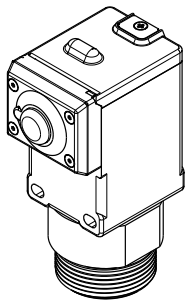

- **Mobility**—Since not tethered by wires, sensor can move with the container. When container is replaced, simply swap out the sensor to the new one
- **Reduce complexity**—Machine or process reconfiguration made easier; great for retrofit applications
- **Deploy easily**—Simplify installation on existing equipment enables deployment in remote and hard-to-access locations where implementing a wired solution would be difficult, impractical, or not cost-effective
- DIP switches for user configuration for sample and report times and transmit power levels of 250 mW or 1 Watt for 900 MHz models
- Frequency Hopping Spread Spectrum (FHSS) technology ensures reliable data delivery
- Transceivers provide bidirectional communication between the Gateway and Node, including fully acknowledged data transmission
- Diagnostics allow user-defined output settings in the unlikely event of lost RF signal

## Models

Model	Ultrasonic Input Range and Frequency	Radio Frequency	Inputs and Outputs
<b>DX80N9Q45UAA</b>	Range: 100 mm to 1 m (3.94 in to 39.4 in)	900 MHz ISM Band	Inputs: One Ultrasonic Input, One Thermistor Input Outputs: One Four-Color LED Indicator Light
<b>DX80N2Q45UAA</b>	Frequency: 240 kHz	2.4 GHz ISM Band	
<b>DX80N9Q45UAC</b>	Range: 300 mm to 3 m (11.8 in to 118 in)	900 MHz ISM Band	Outputs: One Four-Color LED Indicator Light
<b>DX80N2Q45UAC</b>	Frequency: 114 kHz	2.4 GHz ISM Band	

## General Operation

For the first 15 minutes after power up, the Node samples the sensor every 0.25 seconds (fast sample mode). After 15 minutes, the Node defaults to 5 minute sample intervals. Activate fast sample mode by single clicking the button (the amber LED is solid).

## Storage Mode

While in **storage mode**, the device's radio does not operate, to conserve the battery. To put any device into storage mode, press and hold the binding button for five seconds. The device is in storage mode when the LEDs stop blinking. To wake the device, press and hold the binding button (inside the housing on the radio board) for five seconds.



## Slow Scan Mode

In slow scan mode, the device enters a deeper sleep mode to conserve battery power after the device loses its communication link with its parent or master radio. The device wakes up periodically to search for its parent radio. If a parent or master radio is not found, the device goes back to sleep for another sleep cycle. If the parent or master radio is detected, the device exits slow scan mode. To manually exit slow scan mode, press the binding button.

## Principles of Operation

Ultrasonic sensors emit one or multiple pulses of ultrasonic energy, which travel through the air at the speed of sound. A portion of this energy reflects off the target and travels back to the sensor. The sensor measures the total time required for the energy to reach the target and return to the sensor. The distance to the object is then calculated using the following formula: **D = ct ÷ 2**

**D** = distance from the sensor to the target  
**c** = speed of sound in air  
**t** = transit time for the ultrasonic pulse

To improve accuracy, an ultrasonic sensor may average the results of several pulses before outputting a new value.

## Temperature Effects

The speed of sound is dependent upon the composition, pressure and temperature of the gas in which it is traveling. For most ultrasonic applications, the composition and pressure of the gas are relatively fixed, while the temperature may fluctuate.

In air, the speed of sound varies with temperature according to the following approximation:

In metric units:  $C_{m/s} = 20 \sqrt{273 + T_C}$

In English units:  $C_{ft/s} = 49 \sqrt{460 + T_F}$

**C<sub>m/s</sub>** = speed of sound in meters per second  
**T<sub>C</sub>** = temperature in °C

**C<sub>ft/s</sub>** = speed of sound in feet per second  
**T<sub>F</sub>** = temperature in °F

## Temperature Compensation

Changes in air temperature affect the speed of sound, which in turn affects the total time for the echo measured by the sensor. An increase in air temperature shifts both sensing window limits closer to the sensor. Conversely, a decrease in air temperature shifts both limits farther away from the sensor. This shift is approximately 3.5% of the limit distance for a 20° C change in temperature.

The Q45UA series ultrasonic sensors are temperature compensated, to reduce sensor errors from temperature by about 90%. Exposure to direct sunlight can affect the sensor's ability to accurately compensate for changes in temperature.

## Configuration Instructions

### Button and LEDs

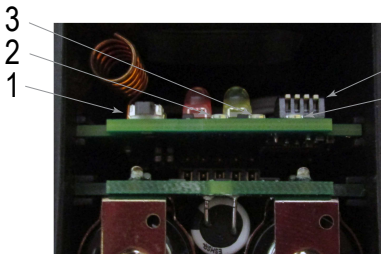

- 1 Binding button
- 2 Red LED (flashing) indicates a radio link error with the Gateway.
- 3 Green LED (flashing) indicates a good radio link with the Gateway.
- 4 Amber LED is not used.
- 5 DIP switches

### DIP Switches

After making any changes to any DIP switch position, reboot the Wireless Q45 Sensor by triple-clicking the button, waiting a second, then double-clicking the button.

The DIP switches are in the OFF position. To turn a DIP switch on, push the switch toward the battery pack. DIP switches one through four are numbered from left to right.

Description	DIP Switches			
	1	2	3	4
Transmit power: 1 Watt	OFF *			
Transmit power: 250 mW (compatible with 150 mW radios)	ON			
Sample/Report Rate: User configured (5 minutes by default)		OFF *	OFF *	
Sample/Report Rate: 16 seconds		OFF	ON	

Description	DIP Switches			
	1	2	3	4
Sample/Report Rate: 64 seconds		ON	OFF	
Sample/Report Rate: Sample on Demand		ON	ON	
Light mode: flash (recommended to conserve the battery) <sup>1</sup>				OFF *
Light mode: solid				ON

\* Default position

### Transmit Power Levels

The 900 MHz radios transmit at 1 Watt (30 dBm) or 250 mW (24 dBm). The 250 mW mode reduces the radio's range but improves the battery life in short range applications. For 2.4 GHz models, this DIP switch is disabled. The transmit power for 2.4 GHz is fixed at about 65 mW EIRP (18 dBm).

### Sample and Report Rates

The sample interval, or rate, defines how often the Sure Cross device samples the input. For battery-powered applications, setting a slower rate extends the battery life.

The report rate defines how often the Node communicates the I/O status to the Gateway. For battery-powered applications, setting the report rate to a slower rate extends the battery life.

### What is Sampling on Demand?

Sample on demand allows a host system to send a Modbus command to a register and require the inputs to immediately sample the sensor and report readings back to the host system and/or Gateway. Sampling on demand can be used between the normal periodic reporting.

The sample on demand feature requires using a host-controlled system capable of sending Modbus commands to the master radio.

### Sample an Input Using a Host System

To sample the input, have the Host System write to the Node's register 15. To calculate which register this is for your Node, use this equation: 15 + (Node # × 16).

1. From the host system, write 0x13xx to the Node's register 15, where xx defines the input you want to sample.

For Input	Write Value (in hex)	Write Value (in decimal)
1	0x1301	4865
2	0x1302	4866
3	0x1304	4868
4	0x1308	4872
5	0x1310	4880
6	0x1320	4896
All Inputs	0x133F	4927

2. To send the Sample on Demand command to more than one input, add together the binary representation values. For example, to demand a sampling of inputs 1, 2, and 3, the Hex command is 0x1307.

### Apply Power to the Q45

Follow these instructions to install or replace the lithium "AA" cell batteries.

As with all batteries, these are a fire, explosion, and severe burn hazard. Do not burn or expose them to high temperatures. Do not recharge, crush, disassemble, or expose the contents to water. Properly dispose of used batteries according to local regulations by taking it to a hazardous waste collection site, an e-waste disposal center, or other facility qualified to accept lithium batteries.

<sup>1</sup> The light consumes most of the sensor's power. If the light remains off most of the time, the batteries will last much longer. In flashing mode, the light can be on for up to one year on a pair of batteries.

Figure 1. Q45 battery board

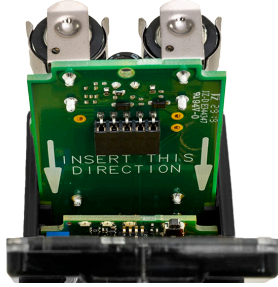

1. Loosen the clamp plate with a small Phillips screwdriver and lift the cover.
2. Slide the battery board out of the Q45 housing.
3. If applicable, remove the discharged batteries.
4. Install the new batteries. Use Banner's **BWA-BATT-006** replacement batteries or an equivalent 3.6 V AA lithium batteries, such as Xeno's XL-60F.
5. Verify the battery's positive and negative terminals align to the positive and negative terminals of the battery holder mounted within the case. Caution: There is a risk of explosion if the battery is replaced incorrectly.
6. Slide the board containing the new batteries back into the Q45 housing.
7. Close the cover and gently tighten the clamp plate with the small Phillips screwdriver.

## Bind to the Gateway and Assign the Node Address

Before beginning the binding procedure, apply power to all the devices. Separate the devices by two meters when running binding procedure. Put only one Gateway into binding at a time to prevent binding to the wrong Gateway.

1. On the Gateway: Enter binding mode.
  - For housed DX80 Gateways, triple-click button 2 on the Gateway. Both LEDs flash red.
  - For Gateway board modules, triple-click the button. The green and red LED flashes.
2. Assign the Q45UA a Node address using the Gateway's rotary dials. Use the left rotary dial for the left digit and the right rotary dial for the right digit. For example, to assign your Q45UA to Node 10, set the Gateway's left dial to 1 and the right dial to 0. Valid Node addresses are 01 through 47.

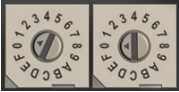

3. On the Q45: Loosen the clamp plate on the top of the Q45UA and lift the cover.
4. Enter binding mode on the Q45UA by triple-clicking the Q45UA's button. The red and green LEDs flash alternately and the sensor searches for a Gateway in binding mode. After the Q45UA is bound, the LEDs stay solid momentarily, then they flash together four times. The Q45UA exits binding mode.
5. Label the sensor with the Q45UA's Node address number for future reference.
6. Repeat steps 2 through 5 for as many Q45UAs as are needed for your network.
7. On the Gateway: After binding all Q45UAs, exit binding mode.
  - For housed DX80 Gateways, double-click button 2.
  - For board-level DX80 Gateways, double-click the button.

For Gateways with single-line LCDs: After binding your Q45UA to the Gateway, make note of the binding code displayed under the Gateway's \*DVCFG menu, XADR submenu on the LCD. Knowing the binding code prevents having to re-bind all Q45UAs if your Gateway is ever replaced.

## Bind to a DXM and Assign the Node Address

Before beginning the binding procedure, apply power to all the devices. Separate the radios by two meters when running the binding procedure. Put only one DXM into binding mode at a time to prevent the Q45UA from binding to the wrong Gateway.

1. On the DXM: Use the arrow keys to select the **ISM Radio** menu on the LCD and click **ENTER**.
2. Highlight the **Binding** menu and click **ENTER**.
3. Use the arrow keys to select the Node address to bind the Q45UA to.
4. On the Q45UA: Loosen the top clamp plate and lift the cover.
5. Enter binding mode by triple-clicking the binding button. The red and green LEDs flash alternately and the sensor searches for a Gateway in binding mode. After the Node binds, the LEDs stay solid momentarily, then they flash together four times. The Node exits binding mode.
6. Label the sensor with the Node address number for future reference.
7. On the DXM: Click **BACK** to exit binding for that specific Node address.
8. Repeat steps 3 through 7 and change the Node address for as many Q45UAs as are needed for your network.
9. On the DXM: After you have finished forming your network, click **BACK** until you reach the main menu.

## Modbus Registers

I/O #	Modbus Holding Register		I/O Type *	I/O Range		Holding Register Representation	
	Gateway	Any Node		Min.	Max.	Min.	Max.
1	1	1 + (Node# × 16)	Distance (mm)	0	65535	0	65535
2	2	2 + (Node# × 16)	Temp °C	-1638.4	1638.3	-32768	32767
3	3	3 + (Node# × 16)	Temp °F	-1636.4	1638.3	-32768	32767
4	4	4 + (Node# × 16)	Distance (in)	0	655.35	0	65535
5	5	5 + (Node# × 16)					
6	6	6 + (Node# × 16)					
7	7	7 + (Node# × 16)	Reserved				
8	8	8 + (Node# × 16)	Device Message				
9	9	9 + (Node# × 16)	Discrete OUT 1: Red Light	0	1	0	1
10	10	10 + (Node# × 16)	Discrete OUT 2: Yellow Light	0	1	0	1
11	11	11 + (Node# × 16)	Discrete OUT 3: Green Light	0	1	0	1
12	12	12 + (Node# × 16)	Discrete OUT 4: Blue Light	0	1	0	1
		...					
15	15	15 + (Node# × 16)	Control Message				
16	16	16 + (Node# × 16)	Reserved				

Distance readings below the listed minimums result in a register value of 0. If no reflection is received because the target is too far away, the register value is an error value of 65535.

- 250 mm (9.84 in) for the **UAC** models
- 75 mm (2.95 in) for the **UAA** models

The temperature = (Modbus register value) ÷ 20. The distance (in) = (Modbus register value) ÷ 100.

## Specifications

### Performance Radio with Internal Antenna Specifications

#### Radio Range<sup>2</sup>

900 MHz, 1 Watt: Up to 3.2 km (2 miles) with line of sight (internal antenna)  
 2.4 GHz, 65 mW: Up to 1000 m (3280 ft) with line of sight (internal antenna)

#### Antenna Minimum Separation Distance

900 MHz, 150 mW and 250 mW: 2 m (6 ft)  
 900 MHz, 1 Watt: 4.57 m (15 ft)  
 2.4 GHz, 65 mW: 0.3 m (1 ft)

#### Radio Transmit Power

900 MHz, 1 Watt: 30 dBm (1 W) conducted (up to 36 dBm EIRP)  
 2.4 GHz, 65 mW: 18 dBm (65 mW) conducted, less than or equal to 20 dBm (100 mW) EIRP

#### Link Timeout (Performance)

Gateway: Configurable via User Configuration Software  
 Node: Defined by Gateway

#### Spread Spectrum Technology

FHSS (Frequency Hopping Spread Spectrum)

#### 900 MHz Compliance (1 Watt)

FCC ID UE3RM1809: FCC Part 15, Subpart C, 15.247  
 IC: 7044A-RM1809  
 IFT: RCPBARM13-2283



(NOM approval only applies to 900 MHz models)

#### 2.4 GHz Compliance

FCC ID UE300DX80-2400: FCC Part 15, Subpart C, 15.247  
 Radio Equipment Directive (RED) 2014/53/EU  
 IC: 7044A-DX8024

ANATEL: 15966-21-04042 Este equipamento não tem direito à proteção contra interferência prejudicial e não pode causar interferência em sistemas devidamente autorizados. Para maiores informações, consulte o site da ANATEL [www.gov.br/anatel/pt-br/](http://www.gov.br/anatel/pt-br/)

### Wireless Q45UA Ultrasonic Sensor Node Specifications

#### Model UAC Performance

Sensing range: 300 mm to 3 m (11.8 in to 118 in)  
 Ultrasonic frequency: 114 kHz  
 Temperature effect: 0.02% of distance/°C  
 Resolution: 1 mm

#### Model UAA Performance

Sensing range: 100 mm to 1 m (3.94 to 39.4 in)  
 Ultrasonic Frequency: 240 kHz  
 Temperature effect: 0.02% of distance/°C  
 Resolution: 1 mm

#### Indicators

Red and green LEDs (radio function)

#### Construction

Molded reinforced thermoplastic polyester housing, oring-sealed transparent Lexan® cover, molded acrylic lenses, and stainless steel hardware.  
 Designed to withstand 1200 psi washdown.

#### Default Sensing Interval

5 minutes

#### Typical Battery Life

See [Battery Life](#) on page 6

<sup>2</sup> Range depends on the environment and decreases significantly without line of sight. Always verify your wireless network's range by performing a Site Survey.

## Environmental Specifications

### Operating Conditions

-40 °C to +70 °C (-40 °F to +158 °F); 90% at +50 °C maximum relative humidity (non-condensing)  
Radiated Immunity: 10 V/m (EN 61000-4-3)

### Environmental Rating

NEMA 6P, IP67

Operating the devices at the maximum operating conditions for extended periods can shorten the life of the device.

## Performance Curves

### UAC Models (3 Meter)

Figure 2. With Plate Target (Typical)

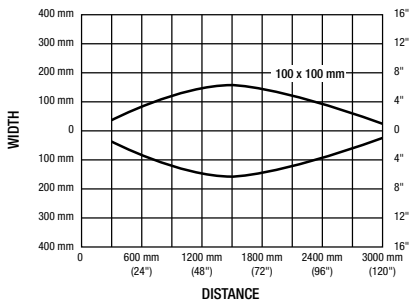

Figure 3. With Rod Target (Typical)

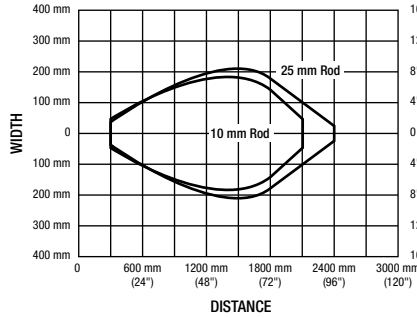
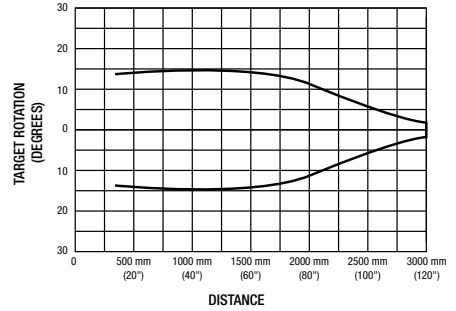

Figure 4. Maximum Target Rotation Angle



### UAA Models (1 Meter)

Figure 5. With Plate Target (Typical)

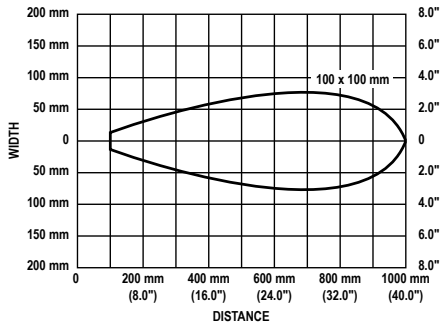

Figure 6. With Rod Target (Typical)

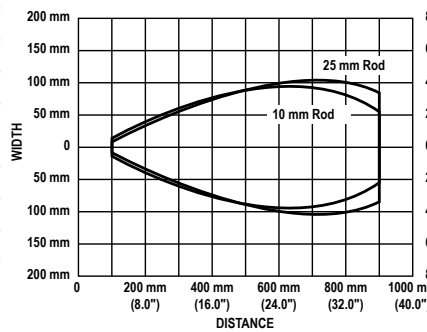
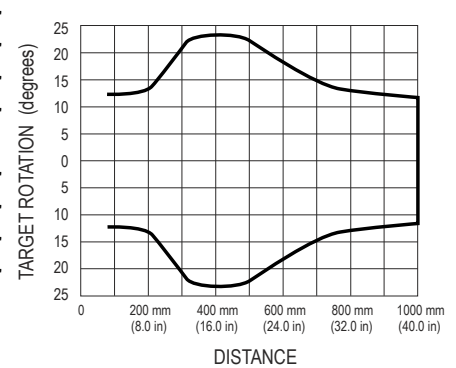
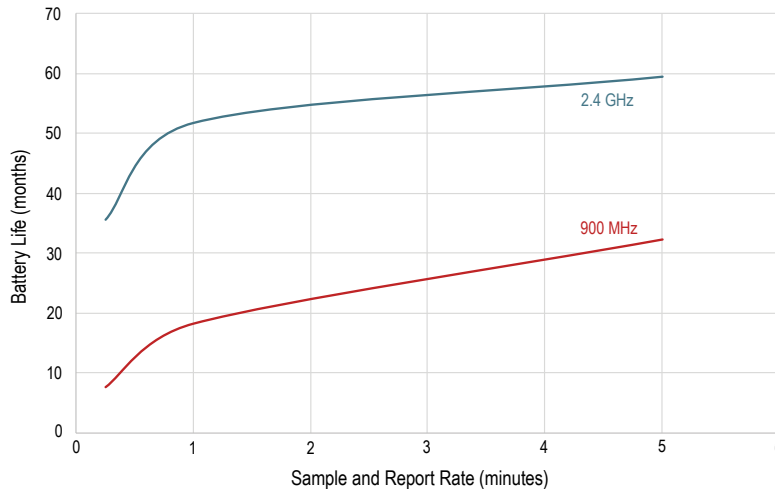

Figure 7. Maximum Target Rotation Angle



## Battery Life

Figure 8. Battery life for the Q45UA



## Dimensions

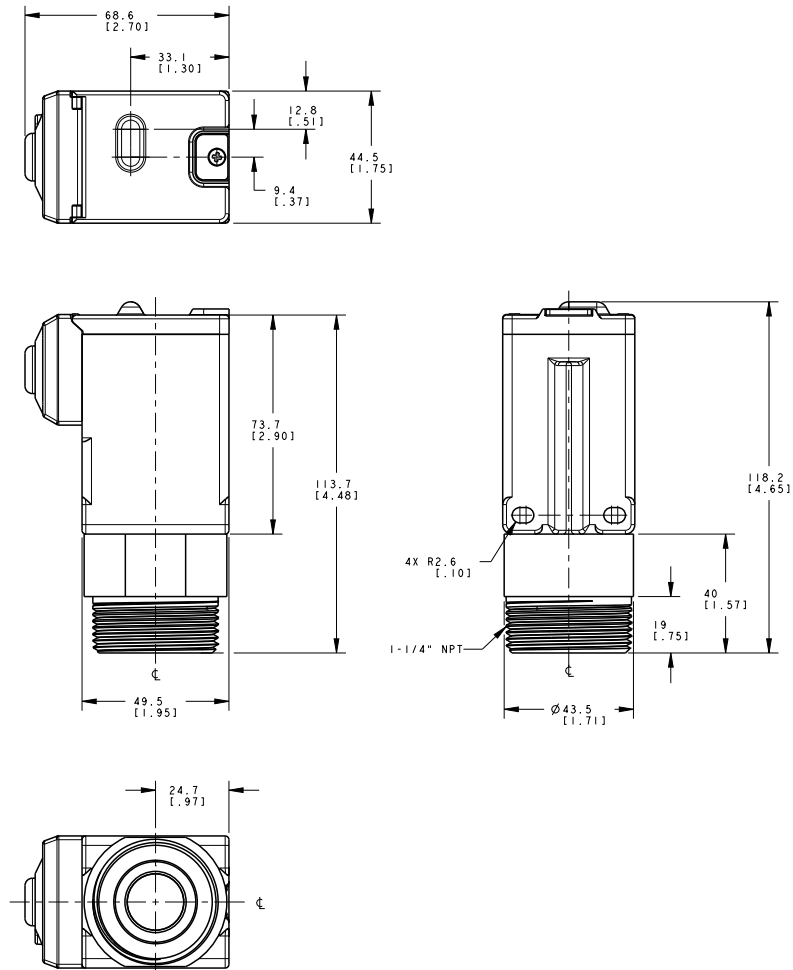

## Warnings

**Exporting Sure Cross® Radios.** It is our intent to fully comply with all national and regional regulations regarding radio frequency emissions. **Customers who want to re-export this product to a country other than that to which it was sold must ensure the device is approved in the destination country.** The Sure Cross wireless products were certified for use in these countries using the antenna that ships with the product. When using other antennas, verify you are not exceeding the transmit power levels allowed by local governing agencies. This device has been designed to operate with the antennas listed on Banner Engineering's website and having a maximum gain of 9 dBm. Antennas not included in this list or having a gain greater than 9 dBm are strictly prohibited for use with this device. The required antenna impedance is 50 ohms. To reduce potential radio interference to other users, the antenna type and its gain should be so chosen such that the equivalent isotropically radiated power (EIRP) is not more than that permitted for successful communication. Consult with Banner Engineering Corp. if the destination country is not on this list.



**Important:** Please download the complete Wireless Q45UA All-in-One Ultrasonic Sensor Node technical documentation, available in multiple languages, from [www.bannerengineering.com](http://www.bannerengineering.com) for details on the proper use, applications, Warnings, and installation instructions of this device.



**Important:** Por favor descargue desde [www.bannerengineering.com](http://www.bannerengineering.com) toda la documentación técnica de los Wireless Q45UA All-in-One Ultrasonic Sensor Node, disponibles en múltiples idiomas, para detalles del uso adecuado, aplicaciones, advertencias, y las instrucciones de instalación de estos dispositivos.



**Important:** Veuillez télécharger la documentation technique complète des Wireless Q45UA All-in-One Ultrasonic Sensor Node sur notre site [www.bannerengineering.com](http://www.bannerengineering.com) pour les détails sur leur utilisation correcte, les applications, les notes de sécurité et les instructions de montage.



**WARNING:**

- **Do not use this device for personnel protection**
- Using this device for personnel protection could result in serious injury or death.
- This device does not include the self-checking redundant circuitry necessary to allow its use in personnel safety applications. A device failure or malfunction can cause either an energized (on) or de-energized (off) output condition.



**Important:**

- **Electrostatic discharge (ESD) sensitive device**
- ESD can damage the device. Damage from inappropriate handling is not covered by warranty.
- Use proper handling procedures to prevent ESD damage. Proper handling procedures include leaving devices in their anti-static packaging until ready for use; wearing anti-static wrist straps; and assembling units on a grounded, static-dissipative surface.

## Banner Engineering Corp. Limited Warranty

Banner Engineering Corp. warrants its products to be free from defects in material and workmanship for one year following the date of shipment. Banner Engineering Corp. will repair or replace, free of charge, any product of its manufacture which, at the time it is returned to the factory, is found to have been defective during the warranty period. This warranty does not cover damage or liability for misuse, abuse, or the improper application or installation of the Banner product.

**THIS LIMITED WARRANTY IS EXCLUSIVE AND IN LIEU OF ALL OTHER WARRANTIES WHETHER EXPRESS OR IMPLIED (INCLUDING, WITHOUT LIMITATION, ANY WARRANTY OF MERCHANTABILITY OR FITNESS FOR A PARTICULAR PURPOSE), AND WHETHER ARISING UNDER COURSE OF PERFORMANCE, COURSE OF DEALING OR TRADE USAGE.**

This Warranty is exclusive and limited to repair or, at the discretion of Banner Engineering Corp., replacement. **IN NO EVENT SHALL BANNER ENGINEERING CORP. BE LIABLE TO BUYER OR ANY OTHER PERSON OR ENTITY FOR ANY EXTRA COSTS, EXPENSES, LOSSES, LOSS OF PROFITS, OR ANY INCIDENTAL, CONSEQUENTIAL OR SPECIAL DAMAGES RESULTING FROM ANY PRODUCT DEFECT OR FROM THE USE OR INABILITY TO USE THE PRODUCT, WHETHER ARISING IN CONTRACT OR WARRANTY, STATUTE, TORT, STRICT LIABILITY, NEGLIGENCE, OR OTHERWISE.**

Banner Engineering Corp. reserves the right to change, modify or improve the design of the product without assuming any obligations or liabilities relating to any product previously manufactured by Banner Engineering Corp. Any misuse, abuse, or improper application or installation of this product or use of the product for personal protection applications when the product is identified as not intended for such purposes will void the product warranty. Any modifications to this product without prior express approval by Banner Engineering Corp will void the product warranties. All specifications published in this document are subject to change; Banner reserves the right to modify product specifications or update documentation at any time. Specifications and product information in English supersede that which is provided in any other language. For the most recent version of any documentation, refer to: [www.bannerengineering.com](http://www.bannerengineering.com).

For patent information, see [www.bannerengineering.com/patents](http://www.bannerengineering.com/patents).

## Notas Adicionales

Información México: La operación de este equipo está sujeta a las siguientes dos condiciones: 1) es posible que este equipo o dispositivo no cause interferencia perjudicial y 2) este equipo debe aceptar cualquier interferencia, incluyendo la que pueda causar su operación no deseada.

Banner es una marca registrada de Banner Engineering Corp. y podrán ser utilizadas de manera indistinta para referirse al fabricante. "Este equipo ha sido diseñado para operar con las antenas tipo Omnidireccional para una ganancia máxima de antena de 6 dBd y Yagi para una ganancia máxima de antena 10 dBd que en seguida se enlistan. También se incluyen aquellas con aprobación ATEX tipo Omnidireccional siempre que no excedan una ganancia máxima de antena de 6dBd. El uso con este equipo de antenas no incluidas en esta lista o que tengan una ganancia mayor que 6 dBd en tipo omnidireccional y 10 dBd en tipo Yagi, quedan prohibidas. La impedancia requerida de la antena es de 50 ohms."

Antenas SMA	Modelo	Antenas Tipo-N	Modelo
Antena, Omni 902-928 MHz, 2 dBd, junta de caucho, RP-SMA Macho	<b>BWA-902-C</b>	Antena, Omni 902-928 MHz, 6 dBd, fibra de vidrio, 1800mm, N Hembra	<b>BWA-906-A</b>
Antena, Omni 902-928 MHz, 5 dBd, junta de caucho, RP-SMA Macho	<b>BWA-905-C</b>	Antena, Yagi, 900 MHz, 10 dBd, N Hembra	<b>BWA-9Y10-A</b>

## Mexican Importer

Banner Engineering de México, S. de R.L. de C.V.  
 David Alfaro Siqueiros 103 Piso 2 Valle oriente  
 San Pedro Garza García Nuevo León, C. P. 66269  
 81 8363.2714

## ANATEL

Modelo (Model): DX80-2400—Este equipamento não tem direito à proteção contra interferência prejudicial e não pode causar interferência em sistemas devidamente autorizados. Para maiores informações, consulte o site da ANATEL [www.gov.br/anatel/pt-br](http://www.gov.br/anatel/pt-br)



ANATEL: 15966-21-04042