

# DEBIX Model A I/O Board

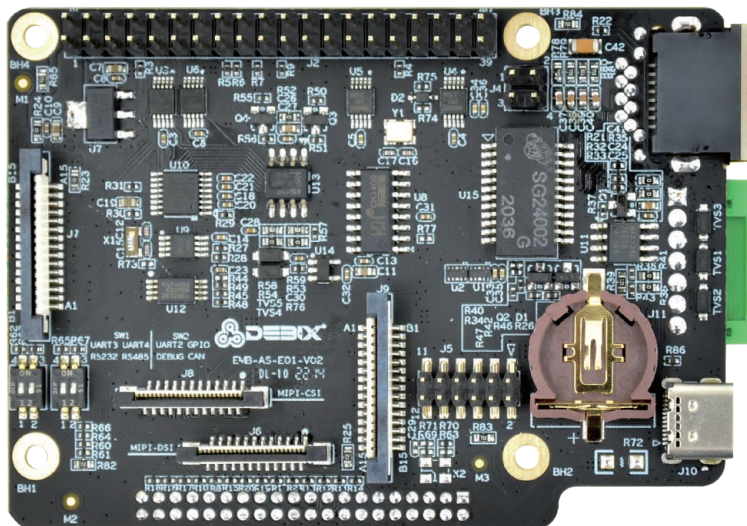

## DEBIX Model A I/O Board

### Overview:

DEBIX Model A I/O Board is an add-on board designed for DEBIX Model A. It adds one RJ45 Gigabit network interface and PoE capability to your DEBIX Model A. It comes with RS232, RS485 and CAN Transceiver to allow connection with more industrial equipment, and its strong expansion ability brings unlimited possibilities.

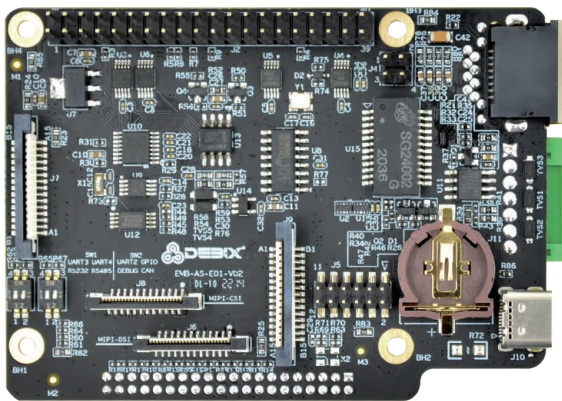

(Front View)

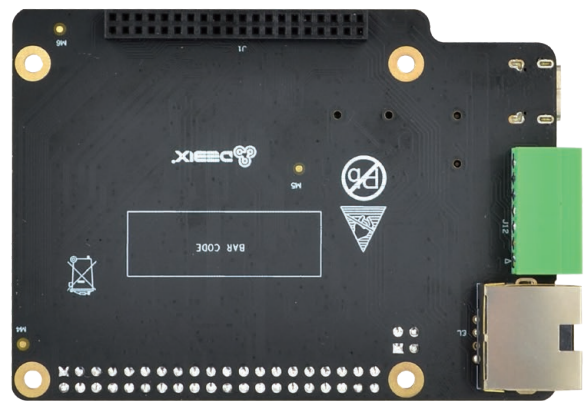

(Back View)

### Specification:

#### I/O Interfaces

Network	1 x RJ45 Gigabit Network POE Supported (Compatible with POE power device module)
USB	1 x USB Type-C Debug (USB to Serial)
RTC	1 x RTC
Serial Ports	1 x RS232 1 x RS485
CAN	1 x CAN Transceiver
DIP Switch	2 x 2bit DIP Switch (used for selecting USB-Debug, RS232, RS485 and CAN)

#### Expansion

40-Pin Double-Row Headers	1) 3 x TTL UART, 2 x SPI, 2 x I2C, 2 x PWM, 2 x CLKO, 2 x CAN, 1 x I2S (Dedicated interfaces can be reused as GPIO ports) 2) 1 x SPDIF Digital Audio Input/Output
MIPI CSI	1 x MIPI CSI
MIPI DSI	1 x MIPI DSI
EEPROM	1 x 2Kbit EEPROM

#### Accessories

Cables	2 x Flexible flat cable for DSI & CSI 1 x Female to female jumper wires for Ethernet
--------	---

## Certificates:



## I/O Interfaces:

UART/I2C/CAN/GPIO/SPI...

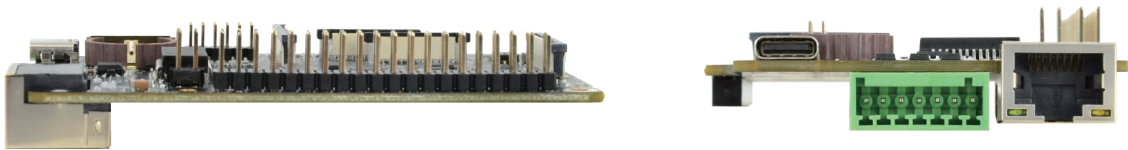
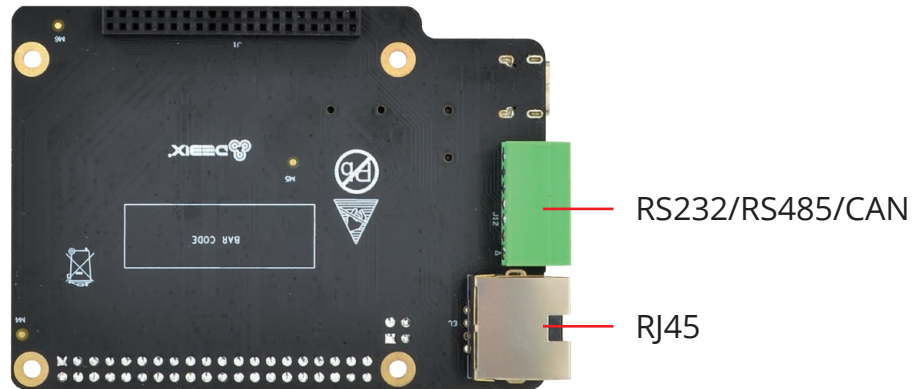
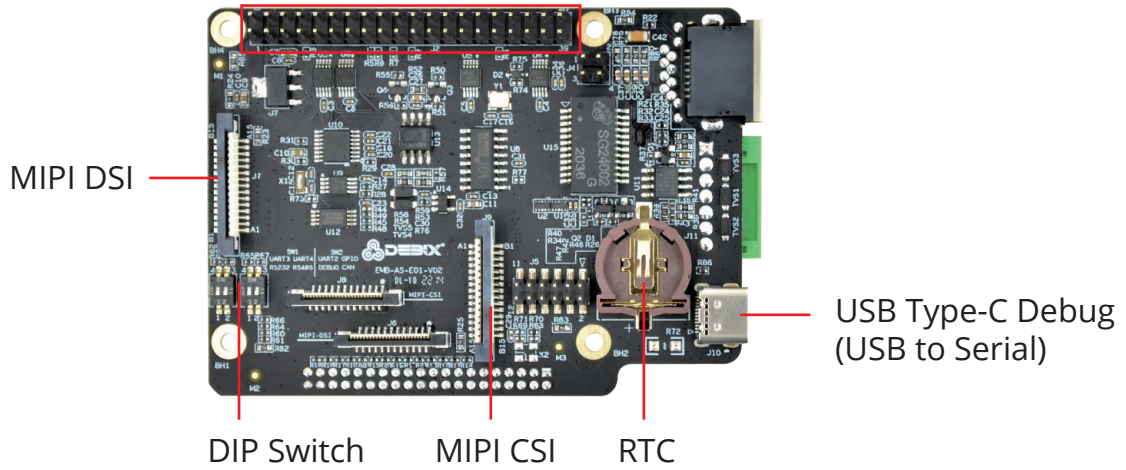

## Connection with DEBIX Model A:

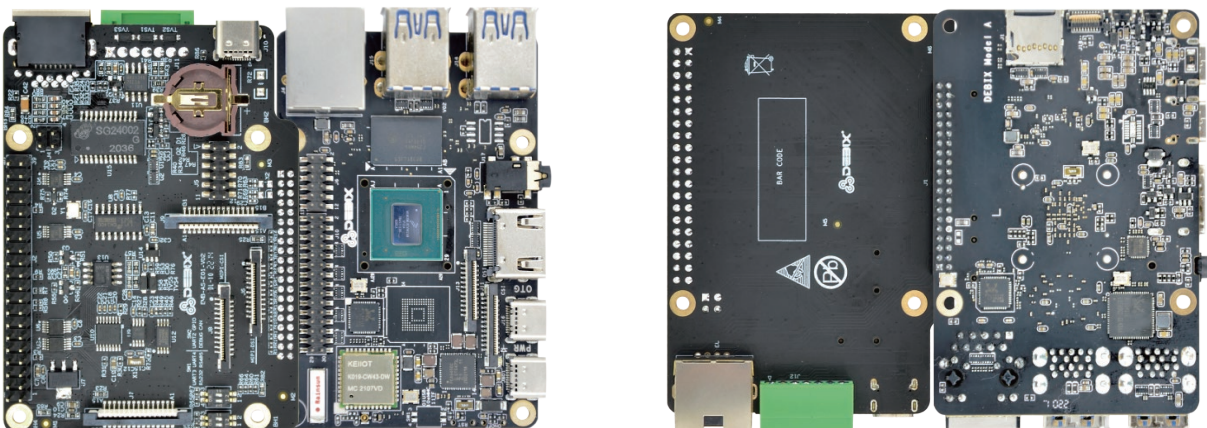

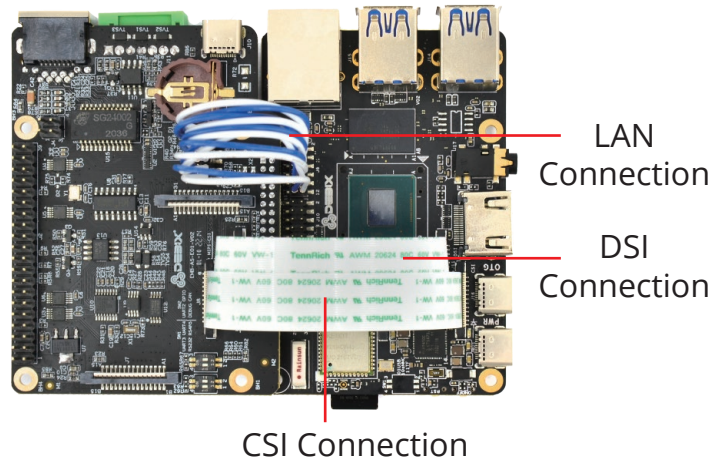
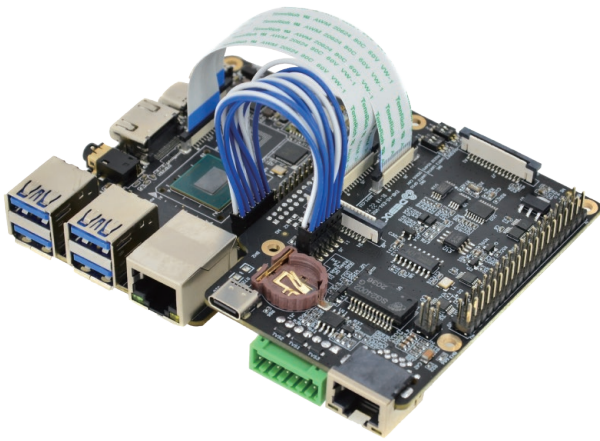

## Safety Instruction:

***To avoid malfunction or damage to this product please observe the following:***

- Do not expose to water, moisture or place on a conductive surface whilst in operation.
- Take care while handling to avoid mechanical or electrical damage to the printed circuit board and connectors.
- Avoid handling the printed circuit board whilst it is powered and only handle by the edges to minimize the risk of electrostatic discharge damage.

## Warnings:

- This product should be used with DEBIX Model A.
- This product should be operated in a well-ventilated environment and, if used inside a case, the case should not be covered.
- This product should be placed on a stable, flat, non-conductive surface in use and should not be contacted by conductive items.
- Where peripherals are connected that do not include the cable or connector, the cable or connector must offer adequate insulation and operation in order that the relevant performance and safety requirements are met.

---

## Contact Us:

OKdo Technology Limited

Address: Fifth Floor, Two Pancras Square, Kings Cross, London N1C 4AG

Telephone: +44(0)203 109 0210

Email: sales@okdo.com; support@okdo.com

Website: www.OKdo.com