

# MINI-BEAM® DC Voltage Series Sensor



## Datasheet

Self-contained photoelectric sensors



- 10 to 30 V DC with bipolar NPN/PNP outputs
- Signal strength or output indicator
- 2 m or 9 m integral cable, or Euro-style quick-disconnect fitting
- 18 mm threaded lens mount on some models









**WARNING:**

- **Do not use this device for personnel protection**
- Using this device for personnel protection could result in serious injury or death.
- This device does not include the self-checking redundant circuitry necessary to allow its use in personnel safety applications. A device failure or malfunction can cause either an energized (on) or de-energized (off) output condition.

## Models

Integral 2 m (6.5 ft) unterminated cable models are listed.

- To order the 9 m (30 ft) PVC cable model, add the suffix "W/30" to the cabled model number. For example, SM31EW/30.
- To order the 4-pin M12/Euro-style QD models, add the suffix "QD" to the model number. For example, SM31EQD.
- To order the 150 mm (6 in) cable with QD, add the suffix "QDP" to the model number. For example, SM31EQDP.
- To order a 0.3 ms response time model, add the suffix "MHS" to the model number. For example, SM31EMHS.

Sensing Mode	Range	LED	Model	
 OPPOSED	Opposed Emitter	Infrared, 880 nm	SM31E	
	Opposed Receiver		SM31R	
	Opposed Emitter - Long Range		30 m (100 ft)	SM31EL
	Opposed Receiver - Long Range			SM31RL
 OPPOSED	Opposed Emitter - Clear Plastic Detection	0 to 300 mm (0 to 12 in) Actual range varies, depending on the light transmission properties of the plastic material being sensed.	SM31EPD	
	Opposed Receiver - Clear Plastic Detection		SM31RPD	
 RETRO	Non-Polarized Retroreflective	Visible red, 650 nm	5 m (15 ft)	SM312LV
 POLAR RETRO	Polarized Retroreflective		55 mm to 2 m (2 in to 7 ft)	SM312LVAG
	Extended-Range Polarized Retroreflective		10 mm to 3 m (0.4 in to 10 ft)	SM312LP
 DIFFUSE	Diffuse	Infrared, 880 nm	380 mm (15 in)	SM312D
			300 mm (12 in)	SM312DBZ
	Divergent Diffuse		130 mm (5 in)	SM312W
 CONVERGENT	Convergent	16 mm (0.65 in) Focus	SM312C	
		43 mm (1.7 in) Focus	SM312C2	

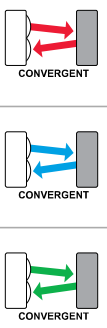
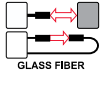
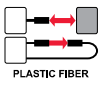

Sensing Mode	Range	LED	Model	
	16 mm (0.65 in) Focus	Visible red, 650 nm	SM312CV	
	43 mm (1.7 in) Focus		SM312CV2	
	16 mm (0.65 in) Focus	Visible blue, 475 nm	SM312CVB	
	49 mm (1.9 in) Focus		SM312CV2B	
	16 mm (0.65 in) Focus	Visible green, 525 nm	SM312CVG	
	49 mm (1.9 in) Focus		SM312CV2G	
	Glass Fiber Optic	Infrared, 880 nm	SM312F	
		Visible red, 650 nm	SM312FV	
		Visible blue, 475 nm	SM312FVB	
		Visible green, 525 nm	SM312FVG	
	Plastic Fiber Optic	Range varies, depending on sensing mode and fiber optics used.	Visible red, 650 nm	SM312FP
			Visible blue, 475 nm	SM312FPB
			Visible green, 525 nm	SM312FPG
Special High-Power Option Plastic Fiber Optic		Visible red, 650 nm	SM312FPH	

## Overview

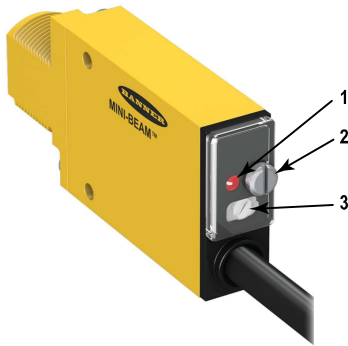

1. Adjustment Indicator Device (AID)
2. Gain (sensitivity) adjustment screw
3. Light/dark operate select switch

Adjust clockwise for light operate (outputs conduct when sensing light is received) and counterclockwise for dark operate (outputs conduct when sensing light is not received).

## Wiring Diagrams

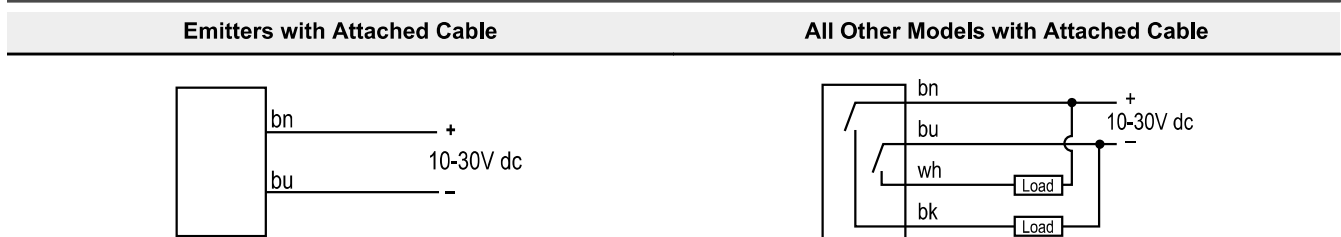

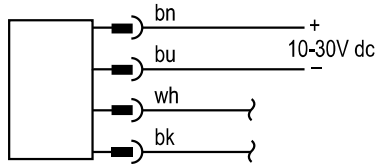
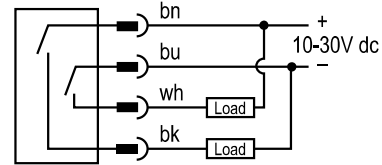
**Emitters with Quick Disconnect (4-pin Euro-Style)****All Other Models with Quick Disconnect (4-pin Euro-Style)**

The output type for all models is Bipolar NPN/PNP; load 150 mA max., each output.

## Sensor Mounting and Alignment

MINI-BEAM sensors perform most reliably if they are properly aligned and securely mounted.

For maximum mechanical stability, mount MINI-BEAM sensors through 18 mm diameter holes by their threaded barrel (where available), or use a mounting bracket. A complete selection of mounting brackets is available. Visit <http://www.bannerengineering.com> or contact Banner Engineering for information on mounting options.

Begin with line-of-sight positioning of the MINI-BEAM sensor to its emitter (opposed-mode sensing) or to its target (all other sensing modes). When using a retroreflective sensor, the target is the retroreflector ("retro target"). For diffuse or convergent sensing modes, the target is the object to be detected.

Apply power to the sensor (and to the emitter, if using the opposed mode). Advance the 15-turn Gain control to maximum (clockwise end of rotation) using a small flat-blade screwdriver. The Gain control is clutched at both ends to avoid damage and will "free-wheel" when either endpoint is reached.

If the MINI-BEAM sensor is receiving its light signal, the red LED Alignment indicator will be ON and flashing at a rate proportional to the signal strength (faster = more signal). Move the sensor (or retro target, if applicable) up-down-right-left (including angular rotation) to find the center of the movement zone within which the LED indicator remains ON. Reducing the Gain setting reduces the size of the movement zone for more precise alignment.

Repeat the alignment motions after each Gain reduction. When optimum alignment is achieved, mount sensor(s) (and the retro target, if applicable) solidly in that position. Increase the Gain to maximum.

Test the sensor by placing the object to be detected in the sensing position, then removing it. The Alignment indicator LED should come ON when the sensing beam is established (Light condition) or be ON when the beam is broken (Dark condition). If the Alignment indicator LED stays ON for both sensing conditions, consider the following tips for each sensing mode.

### Opposed Mode Alignment

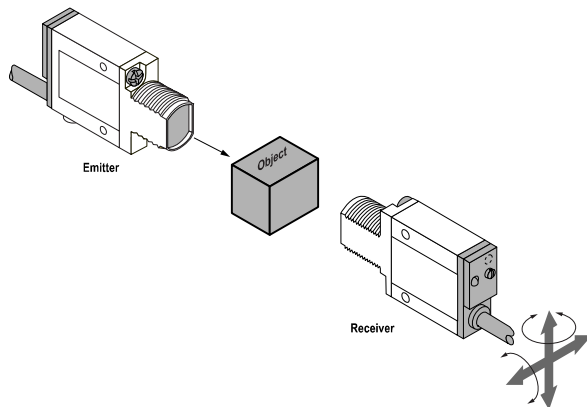

*Flooding* occurs when a portion of the sensing beam passes around the object to be sensed. *Burn-through* occurs when a portion of the emitter's light energy passes through a thin or translucent object, and is sensed by the receiver.

To correct either problem, do one or more of the following to reduce the light energy:

- Reduce the Gain adjustment on the receiver
- Add an aperture to one or both lenses (MINI-BEAM apertures, available from Banner, fit neatly inside the lens assembly)
- Intentionally misalign the emitter and receiver

**Note:**

- Light condition: sensor output is ON when there is no object in the beam
- Dark condition: sensor output is ON when there is an object in the beam

## Diffuse Mode Alignment

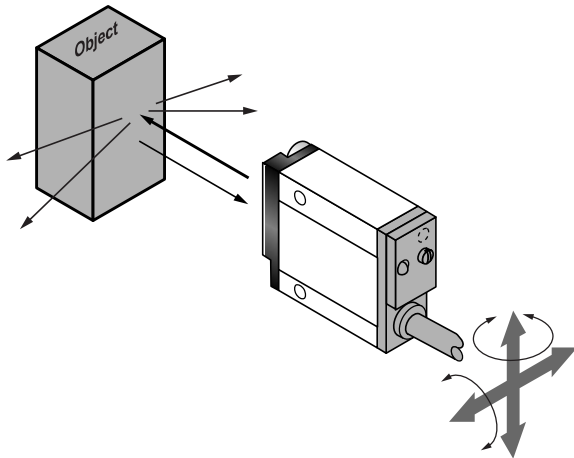

If the Alignment LED does not turn OFF when the object is removed from the beam, the sensor is probably detecting light reflected from some background object. To remedy this problem:

- Reduce the reflectivity of the background by painting the surface(s) flat-black, scuffing any shiny surface, or drilling a large hole, directly opposite the diffuse sensor
- Move the sensor closer to the object to be detected and reduce the Gain adjustment. Rule of thumb for diffuse sensing: The distance to the nearest background object should be at least three times the sensing distance



### Note:

- Light condition: sensor output is ON when there is no object in the beam
- Dark condition: sensor output is ON when there is an object in the beam

## Retroreflective Mode Alignment

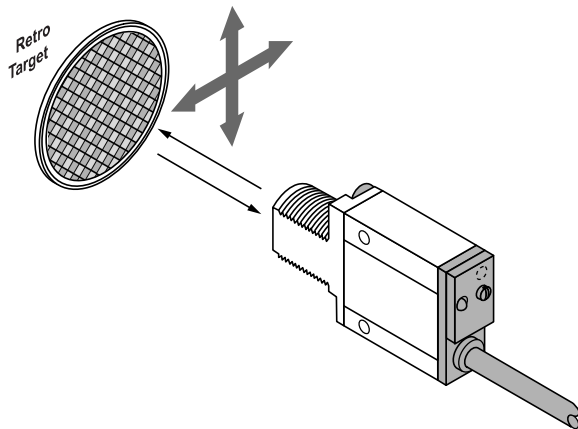

A highly reflective object may reflect enough light back to a retroreflective sensor to allow that object to slip through the beam, without being detected. This problem is called *proxing*, and the following methods may be used to correct it:

- Position the sensor and retro target so the beam will not strike a shiny surface perpendicular to the sensor lens
- Reduce the Gain adjustment
- Add a polarizing filter (for model SM312LV)



### Note:

- Light condition: sensor output is ON when there is no object in the beam
- Dark condition: sensor output is ON when there is an object in the beam

## Convergent Mode Alignment

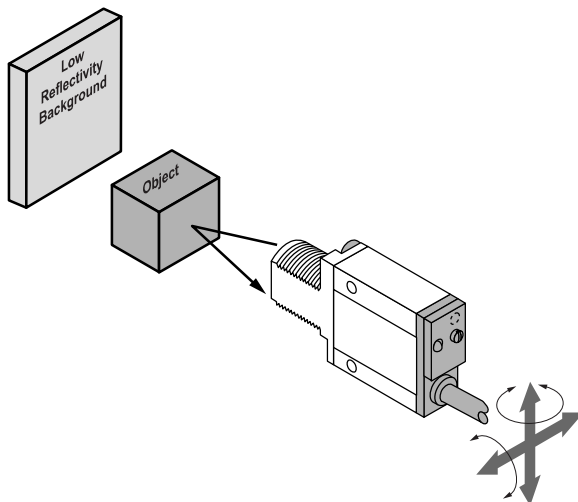

The sensing energy of a convergent mode sensor is concentrated at the specified focus point. Convergent mode sensors are less sensitive to background reflections, compared with diffuse mode sensors. However, if background reflections are a problem:

- Skew the sensor position at a 10° to 25° angle to eliminate direct reflections from shiny background surfaces
- Reduce the reflectivity of the background by painting the surface(s) flat-black, scuffing any shiny surface, or drilling a large hole, directly opposite the sensor
- Reduce the Gain adjustment



### Note:

- Light condition: sensor output is ON when there is no object in the beam
- Dark condition: sensor output is ON when there is an object in the beam

## Installing Plastic Fibers on a MINI-BEAM

Follow these instructions to install plastic fibers into your sensor. MINI-BEAMS may have either a fiber gripper or a clamp screw. **MINI-BEAM** and **ECONO-BEAM** sensors for use with plastic fiber optic assemblies include sensors with the letters **FP** in their model number.

Figure 1. MINI-BEAM with fiber grippers

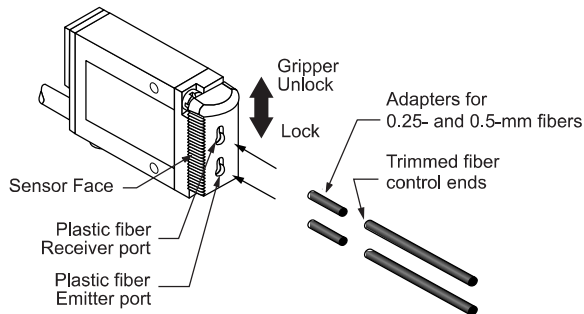
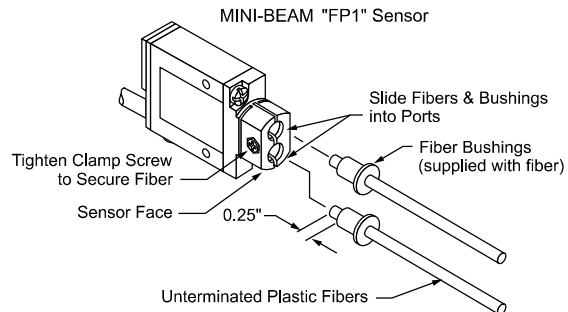

Figure 2. MINI-BEAM with clamp screws



1. Prepare the sensor ends of the fibers (see [Cut the Plastic Fiber](#) on page 5).
2. Prepare the sensor for the fibers.
  - For models with a fiber gripper: Unlock the fiber gripper as shown in the figure and apply the appropriate fiber adapters to the fiber, if needed.
  - For models with a clamp screw: Loosen the clamp screw on the sensor face.
3. Insert the plastic fibers.
  - For models with a fiber gripper: Gently insert the prepared fiber ends into the ports as far as they will go.
  - For models with a clamp screw: Align the fiber ends flush with the ends of the bushings as shown. Hold the bushings to the fibers and slide both into the sensor ports. Push the fiber an additional 1 inch through the bushing.
4. Lock in the fibers.
  - For models with a fiber gripper: Slide the fiber gripper back to lock, as shown in the figure.
  - For models with a clamp screw: Tighten the clamp screw to secure the fibers.

## Cut the Plastic Fiber

An unterminated plastic fiber is designed to be cut by the customer to the length required for the application. To facilitate cutting, a Banner model PFC-4 cutting device is supplied with this fiber.

1. Locate the non-terminated end, and determine the length of fiber required for the application.
2. Lift the top of the cutter to open the cutting ports.
3. Insert the non-terminated end through one of the four large cutting ports on the PFC-4 cutter so that the excess fiber protrudes from the back of the cutter.
4. Double-check the fiber length, and close the cutter until the fiber is cut.
5. Gently wipe the cut ends of the fiber with a clean, dry cloth to remove any contamination.

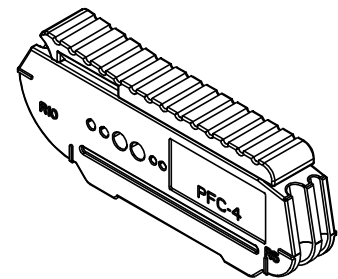

**Note:** Do not use solvents or abrasives on any exposed optical fiber. Do not use a cutting port more than once. The blade may tend to dull after one cut.

## Installing the Glass Fibers in MINI-BEAMS

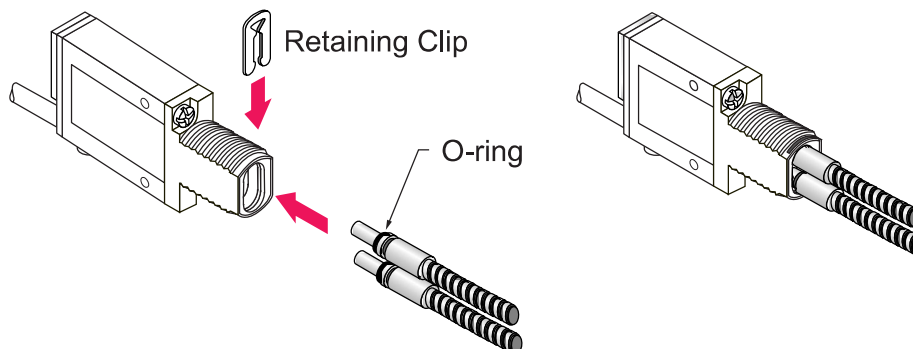

1. Install the O-ring (supplied with the fiber) on each fiber end, as shown in the drawing.
2. While pressing the fiber ends firmly into the ports on the sensor front, slide the U-shaped retaining clip (supplied with the sensor) into the slot in the sensor's barrel, until it snaps into place.

## Specifications

### Supply Voltage and Current

10 to 30 V DC (10% maximum ripple) at less than 25 mA (exclusive of load)

### Supply Protection Circuitry

Protected against reverse polarity and transient voltages

### Output Configuration

Bipolar: One current sourcing (PNP) and one current sinking (NPN) open collector transistor

### Output Rating

150 mA maximum each output at 25 °C, derated to 100 mA at 70 °C (derate  $\approx$  1 mA per °C)  
 OFF State Leakage Current: less than 1 microamp  
 Output Saturation Voltage (PNP Output): less than 1 V at 10 mA, less than 2 V at 150 mA  
 Output Saturation Voltage (NPN Output): less than 200 millivolts at 10 mA, less than 1 V at 150 mA

### Output Protection Circuitry

Protected against false pulse on power-up and continuous overload or short-circuit of outputs

### Output Response Time

Sensors will respond to either a "light" or "dark" signal of 1 millisecond or longer duration, 500 Hz maximum. Modification for 0.3 millisecond response is available (MHS-suffix models; these models also feature reduced sensitivity range and reduced repeatability.)



**Note:** Outputs are non-conducting during 100 millisecond delay on power-up.

### Repeatability

Opposed: 0.14 milliseconds  
 Non-Polarized and Polarized Retro, Diffuse, Convergent, Glass Fiber Optic, and Plastic Fiber Optic: 0.3 milliseconds

Response time and repeatability specifications are independent of signal strength.

### Adjustments

Light/Dark Operate Select switch  
 15-turn slotted brass screw Gain (sensitivity) adjustment potentiometer (clutched at both ends of travel)  
 Located on the rear panel, protected by a gasketed, clear acrylic cover.

### Indicators

Patented Alignment Indicator Device system (AID™, US patent #4356393) lights a rear-panel-mounted LED indicator when the sensor sees light. Its pulse rate is proportional to the light signal strength (the stronger the signal, the faster the pulse rate).

### Construction

Reinforced thermoplastic polyester housing, totally encapsulated, o-ring sealing, acrylic lenses, stainless steel screws

### Environmental Rating

Meets NEMA standards 1, 2, 3, 3S, 4, 4X, 6, 12, and 13; IP67.

### Connections

PVC-jacketed 4-conductor 2 m (6.5 ft) or 9 m (30 ft) cables, or 4-pin M12 male QD fitting; QD cables available separately

### Operating Conditions

-20 °C to +70 °C (-4 °F to +158 °F)  
 90% at +50 °C maximum relative humidity (non-condensing)

### Application Note

The NPN (current sinking) output of dc MINI-BEAM sensors is directly compatible as an input to Banner logic modules, including all non-amplified MAXI-AMP and MICRO-AMP modules. MINI-BEAMs are TTL compatible.

### Required Overcurrent Protection



**WARNING:** Electrical connections must be made by qualified personnel in accordance with local and national electrical codes and regulations.

Overcurrent protection is required to be provided by end product application per the supplied table.

Overcurrent protection may be provided with external fusing or via Current Limiting, Class 2 Power Supply.

Supply wiring leads < 24 AWG shall not be spliced.

For additional product support, go to [www.bannerengineering.com](http://www.bannerengineering.com).

Supply Wiring (AWG)	Required Overcurrent Protection (Amps)
20	5.0
22	3.0
24	2.0
26	1.0
28	0.8
30	0.5

### Certifications



## Performance Curves for SM31Ex Emitter and SM31Rx Receiver Models

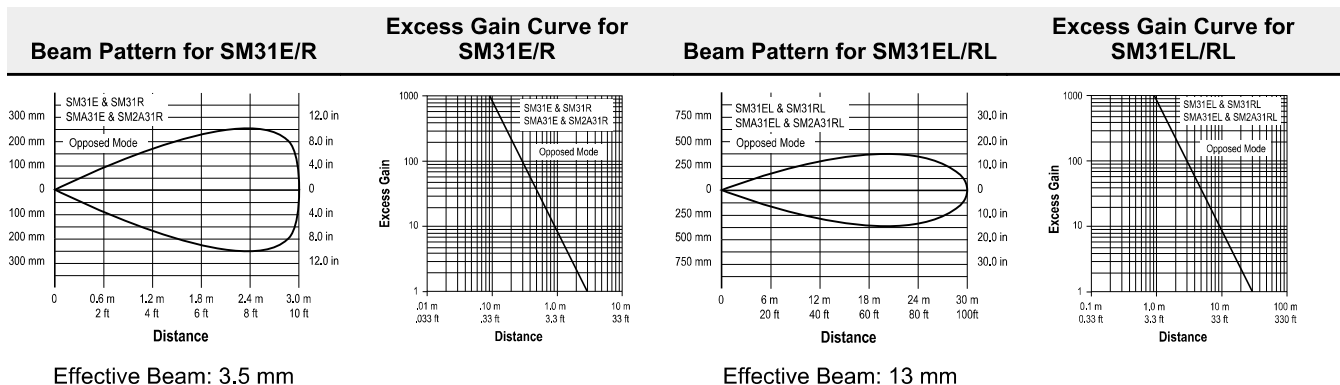

Performance Curves for the SM312Lx Retroreflective Models

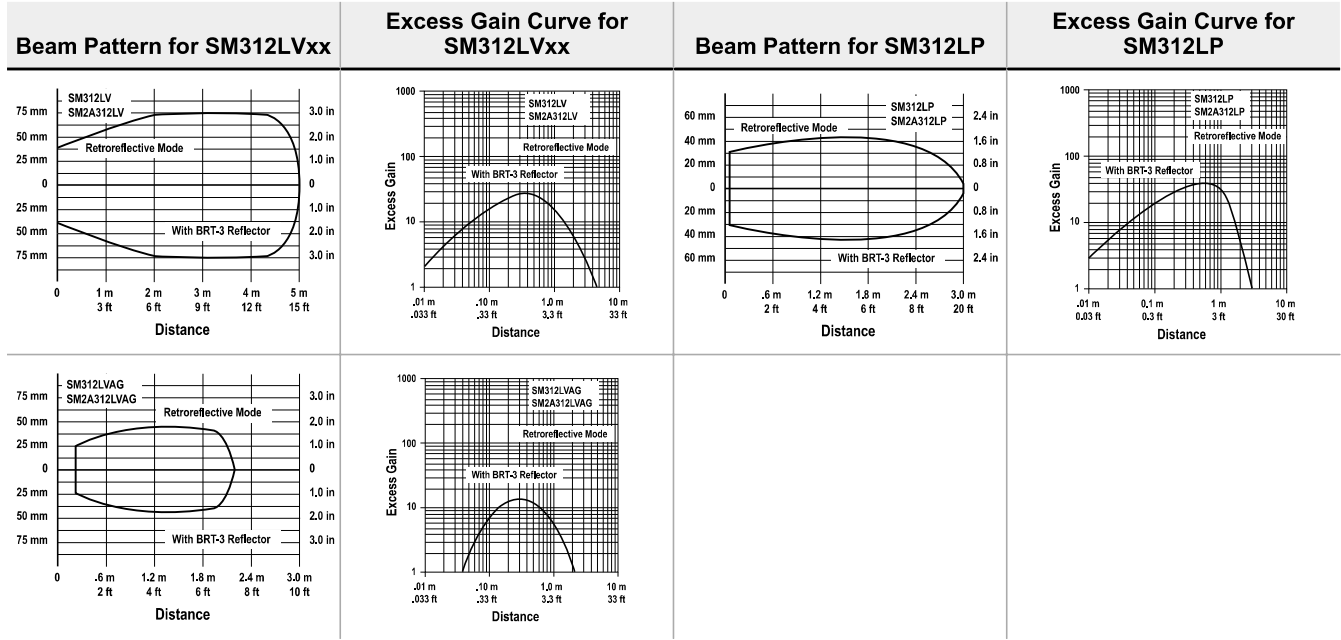

Performance Curves for the SM312Dx and SM312W Diffuse Models

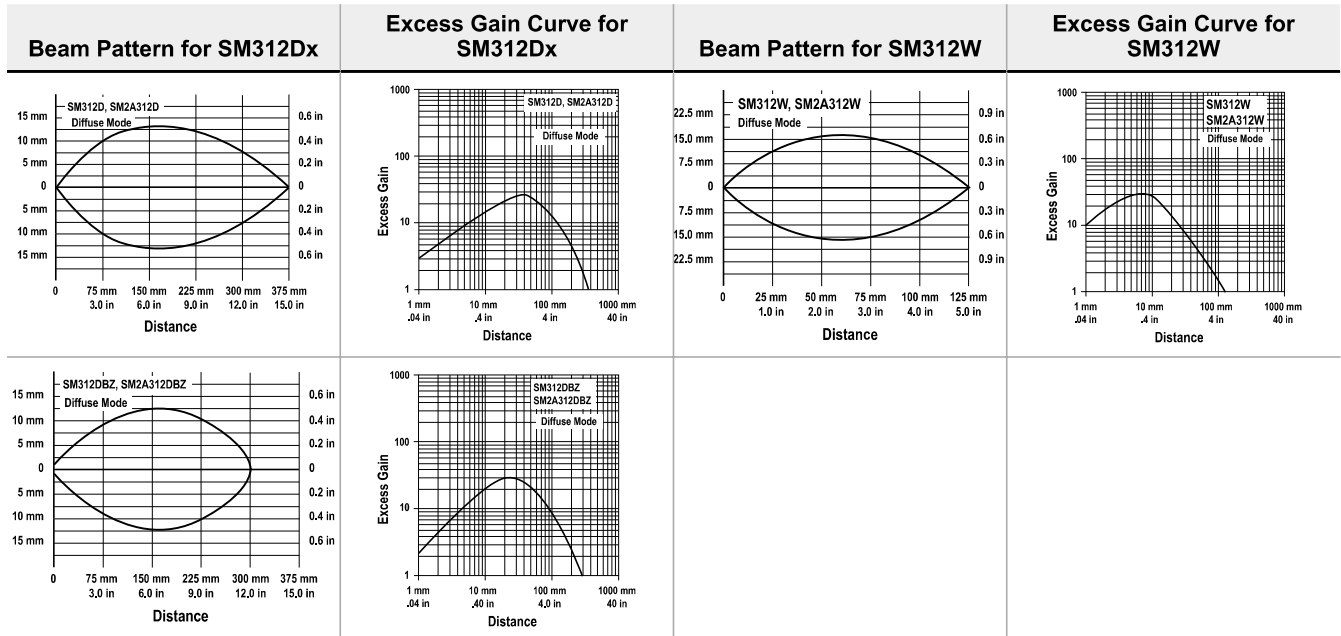

Performance Curves for the SM312Cx Convergent Models

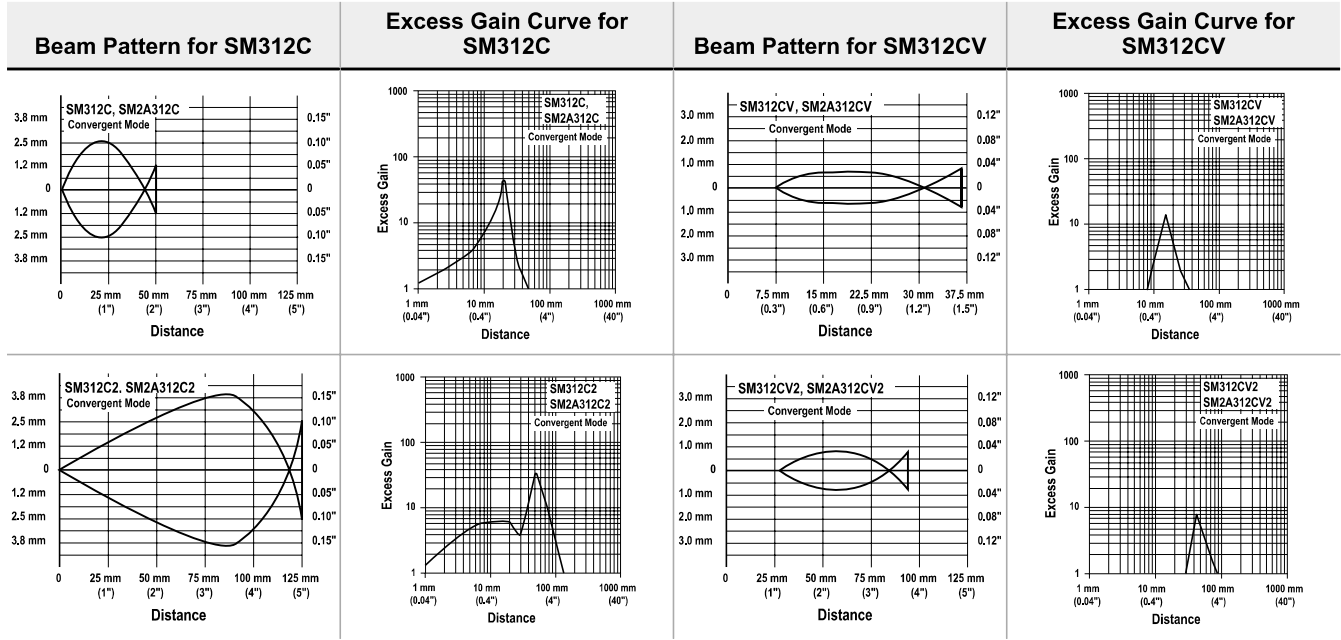

Performance is based on a 90% reflectance white test card.

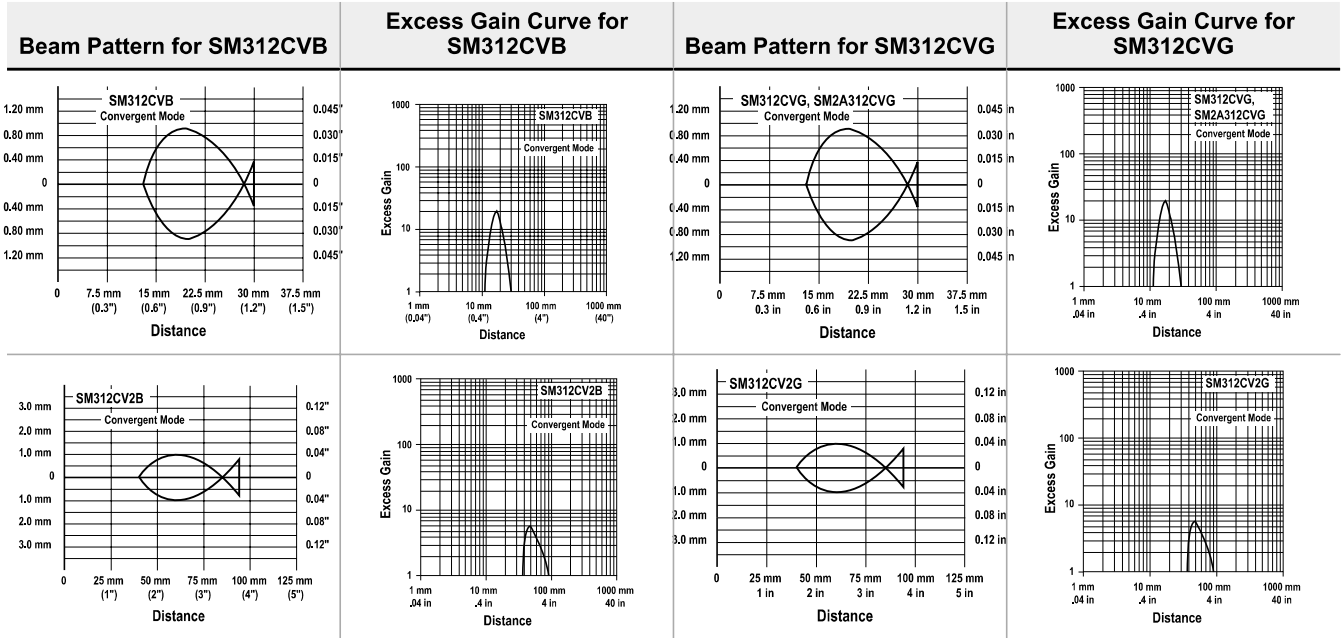



Performance Curves for the SM312F Glass Fiber Optic Models

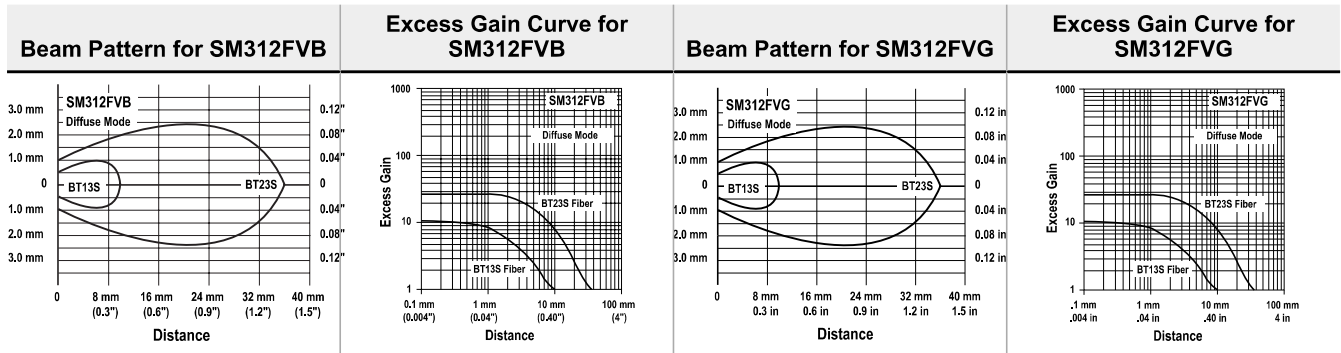
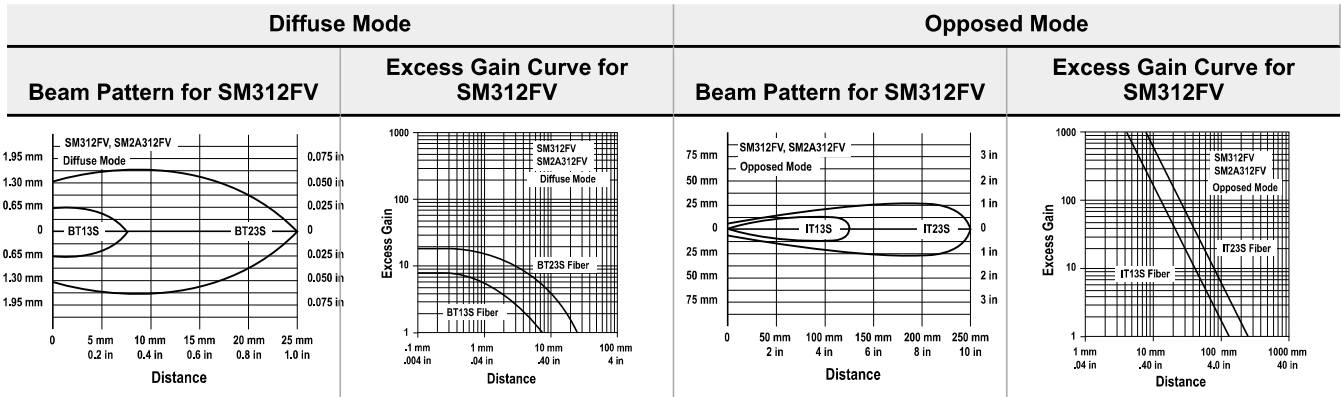
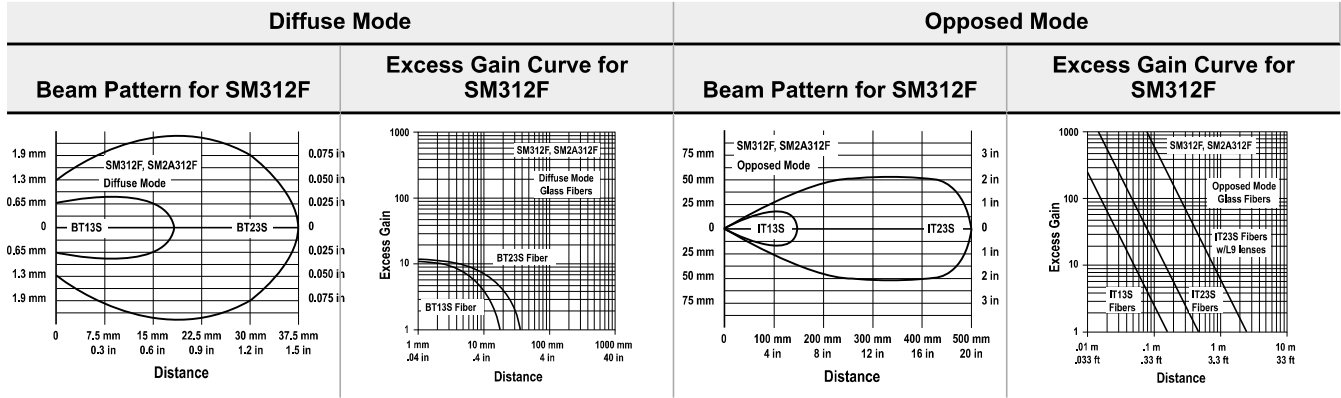

Performance Curves for the SM312FP Plastic Fiber Models

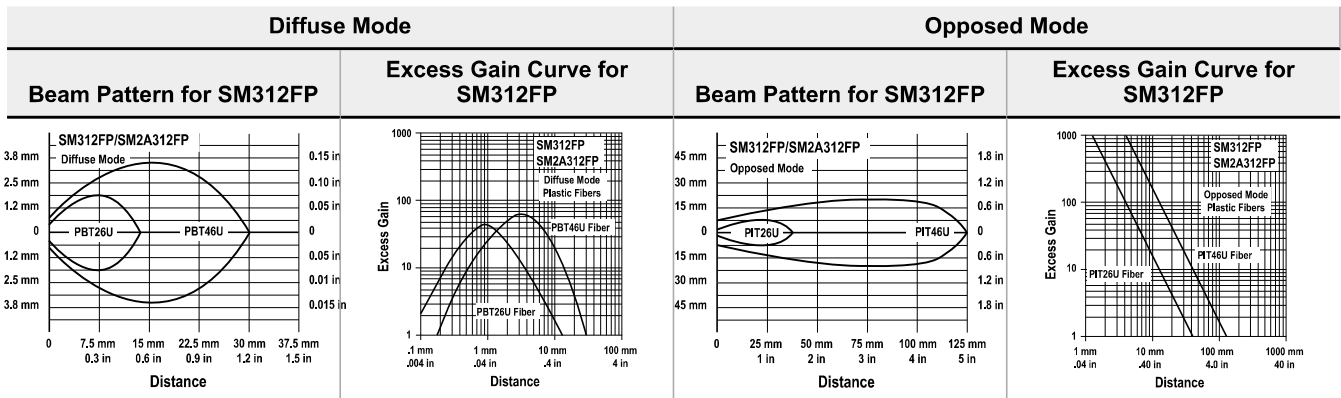

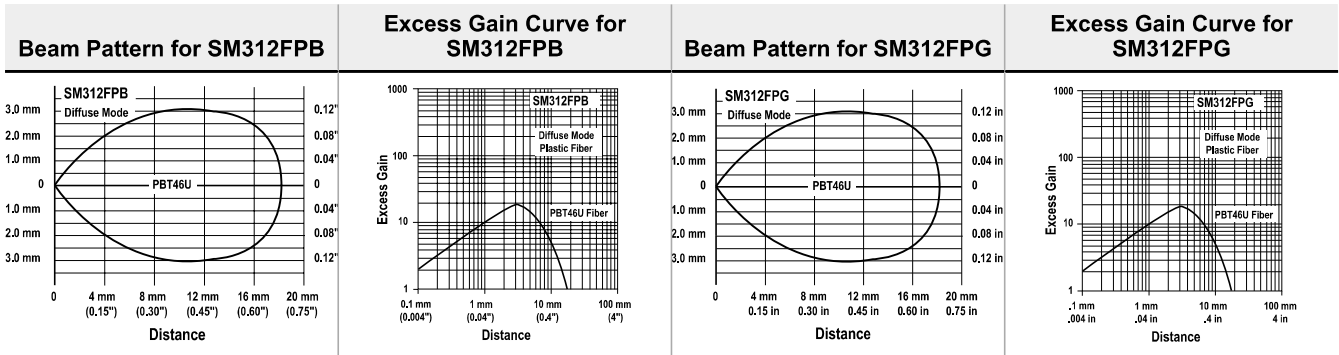

Dimensions

**Cabled Models**

(Suffix E, EL, EPD, R, RL, RPD, LV, LVAG, LP, LPC, D, C, C2, CV, CV2, CVG, CV2G, CVB, CV2B, CVW )

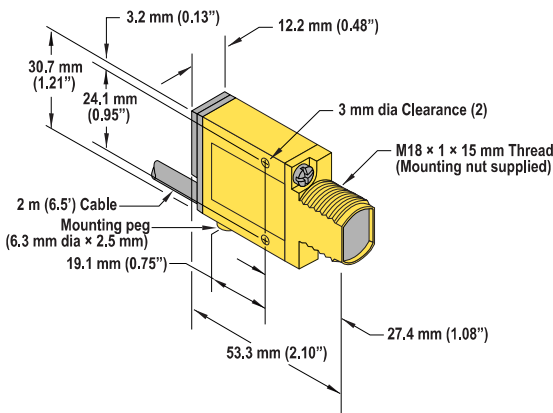

**Divergent Diffuse Models**

(Suffix DBZ and W)

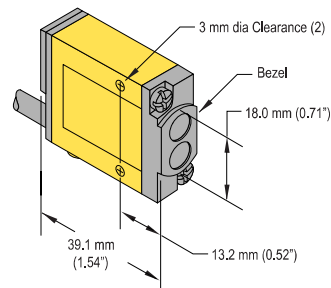

**Glass Fiber Models**

(Suffix F, FV, FVB, FVG, FVW)

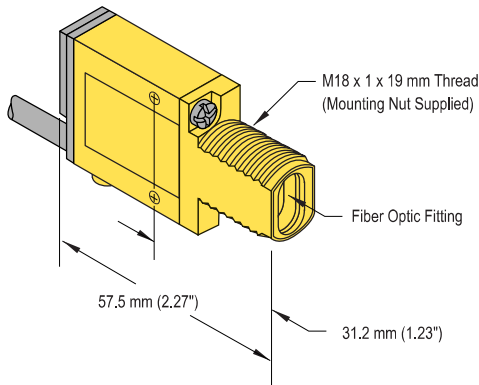

**Plastic Fiber Models**

(Suffix FP, FPB, FPG, FPH, FPW)

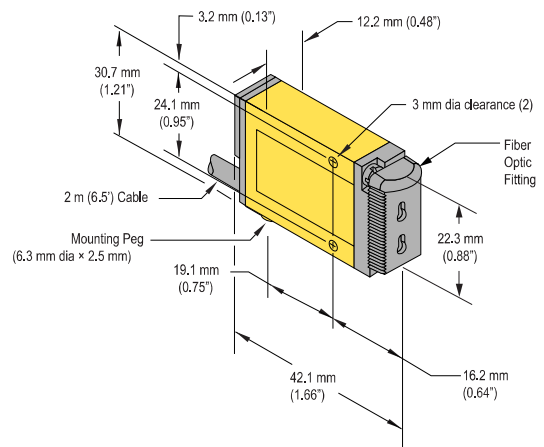

**QD Models**

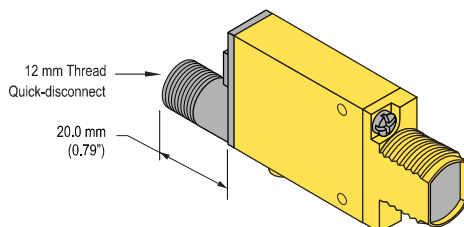

## Accessories

### 4-Pin Euro-Style Cordsets

4-Pin Threaded M12 Cordsets—Single Ended				
Model	Length	Style	Dimensions	Pinout (Female)
MQDC-406	2 m (6.56 ft)	Straight		
MQDC-415	5 m (16.4 ft)			
MQDC-430	9 m (29.5 ft)			
MQDC-450	15 m (49.2 ft)			
MQDC-406RA	2 m (6.56 ft)	Right-Angle		
MQDC-415RA	5 m (16.4 ft)			
MQDC-430RA	9 m (29.5 ft)			
MQDC-450RA	15 m (49.2 ft)			

1 = Brown  
2 = White  
3 = Blue  
4 = Black  
5 = Unused

### Mounting Brackets

#### SMB46L

- Right-angle
- L bracket
- 14-ga. 316 stainless steel

Hole center spacing: A = 16.0

Hole size: A = 16.5 × 18.7

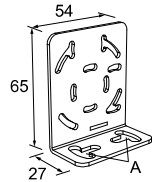

#### SMB46S

- Right-angle
- S bracket
- 14-ga. 316 stainless steel

Hole center spacing: A = 16.0

Hole size: A = 16.5 × 18.7, B = 34.0 × 10.0

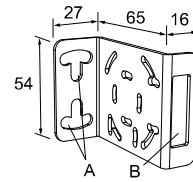

#### SMB46U

- Right-angle
- U bracket for sensor protection
- 14-ga. 316 stainless steel

Hole center spacing: A = 16.0

Hole size: A = 16.5 × 18.7, B = 34.0 × 13.0

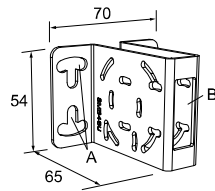

#### SMB18A

- Right-angle mounting bracket with a curved slot for versatile orientation
- 12-ga. stainless steel
- 18 mm sensor mounting hole
- Clearance for M4 (#8) hardware

Hole center spacing: A to B = 24.2

Hole size: A = ø 4.6, B = 17.0 × 4.6, C = ø 18.5

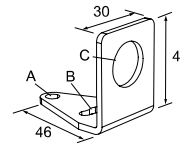

#### SMB18AFA..

- Protective, swivel bracket with tilt and pan movement for precision adjustment
- Easy sensor mounting to extruded rail T-slots
- Metric and inch size bolts available
- Mounting hole for 18 mm sensors

Hole size: B = ø 18.1

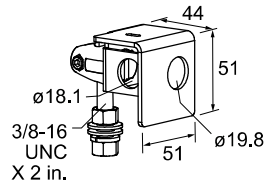

Model	Bolt Thread (A)
SMB18AFA	3/8 - 16 × 2 in
SMB18AFAM10	M10 - 1.5 × 50

#### SMB18Q

- Right-angle flanged bracket
- 18 mm sensor mounting hole
- 12-ga. stainless steel

Hole center spacing: A to B = 24.2

Hole size: A = ø 4.6, B = 17.0 × 4.6, C = ø 19.0

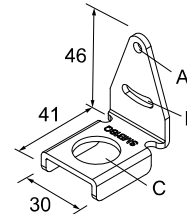

**SMB18SF**

- 18 mm swivel bracket with M18 × 1 internal thread
- Black thermoplastic polyester
- Stainless steel swivel locking hardware included

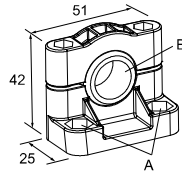

**Hole center spacing:** A = 36.0  
**Hole size:** A =  $\varnothing$  5.3, B =  $\varnothing$  18.0

**SMB18UR**

- 2-piece universal swivel bracket
- 300 series stainless steel
- Stainless steel swivel locking hardware included
- Mounting hole for 18 mm sensor

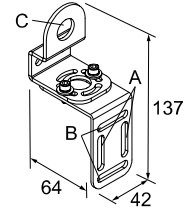

**Hole center spacing:** A = 25.4, B = 46.7  
**Hole size:** B = 6.9 × 32.0, C =  $\varnothing$  18.3

**SMB312PD**

- Right-angle mounting bracket with a curved slot for versatile orientation
- 12-ga. stainless steel
- 18 mm sensor mounting hole
- Clearance for M4 (#8) hardware

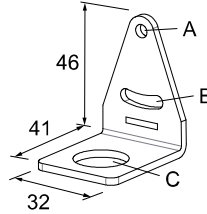

**Hole center spacing:** A to B = 24.2  
**Hole size:** A =  $\varnothing$  4.6, B = 17 × 4.6, C =  $\varnothing$  18.5



**Note:** Not for use with plastic fiber optic sensors

**SMBAMS18RA**

- Right-angle SMBAMS series bracket with 18 mm hole
- Articulation slots for 90+° rotation
- 12-ga. (2.6 mm) cold-rolled steel

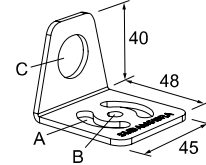

**Hole center spacing:** A = 26.0, A to B = 13.0  
**Hole size:** A = 26.8 × 7.0, B =  $\varnothing$  6.5, C =  $\varnothing$  19.0

**SMBAMS18P**

- Flat SMBAMS series bracket with 18 mm hole
- Articulation slots for 90+° rotation
- 12-ga. (2.6 mm) cold-rolled steel

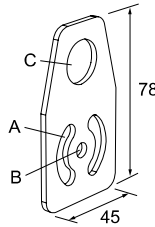

**Hole center spacing:** A = 26.0, A to B = 13.0  
**Hole size:** A = 26.8 × 7.0, B =  $\varnothing$  6.5, C =  $\varnothing$  19.0

**SMB30SK**

- Flat-mount swivel bracket with extended range of motion
- Black reinforced thermoplastic polyester and 316 stainless steel
- Stainless steel swivel locking hardware included

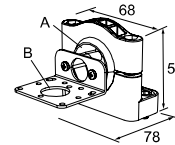

**Hole center spacing:** A = 50.8  
**Hole size:** A =  $\varnothing$  7, B =  $\varnothing$  18

**SMB3018SC**

- 18 mm swivel side or barrel-mount bracket
- Black reinforced thermoplastic polyester
- Stainless steel swivel locking hardware included

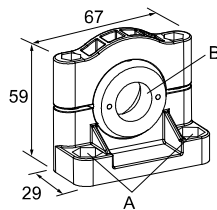

**Hole center spacing:** A = 50.8  
**Hole size:** A =  $\varnothing$  7.0, B =  $\varnothing$  18.0

**SMB30SUS**

- Side-mount swivel with extended range of motion
- Black reinforced thermoplastic polyester
- Stainless steel swivel locking hardware included

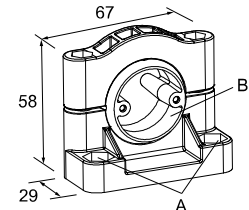

**Hole center spacing:** A = 50.8, B = 24.1  
**Hole size:** A =  $\varnothing$  7, B =  $\varnothing$  7.6

**SMB312S**

- Stainless steel 2-axis, side-mount bracket

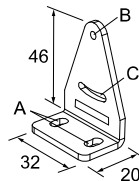

A = 4.3 × 7.5, B = diam. 3, C = 3 × 15.3

**SMB312B**

- Stainless steel 2-axis, bottom-mount bracket
- Includes mounting foot

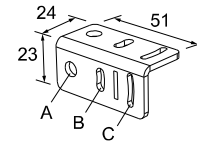

A = diam. 6.9, B = 4.3 × 10.5, C = 3.1 × 15.2

### Miscellaneous Accessories and Replacement Parts

MINI-BEAM lens assemblies are field-replaceable.

Replacement Lens Model	Replacement Lens for MINI-BEAM Model	Possible Sensing Mode or Range Changes
UC-300AG	LVAG	LV to LVAG
UC-300BZ	W and DBZ	D to DBZ and F to DBZ
UC-300C..7	C, CV, and CVG	CV2 to CV
UC-300C2	C2 and CV2	CV to CV2
UC-300E	E and R	-
UC-300EL	EL and RL	Extends the range of the E/R models
UC-300EPD	EPD	-
UC-300F	F and FV	D to F and DBZ to F
UC-300FP	FP (old style)	-
UC-300FP2	FP	-
UC-300L	LV and D	F to D, LVAG to LV, and DBZ to D
UC-300LP	LP	-
UC-300RPD	RPD	-



MINI-BEAM right-angle reflectors are useful for tight sensing locations. These reflectors significantly decrease excess gain.

#### Right-Angle Reflectors

##### RAR300SM

- Side mount right-angle reflector
- Profile dimension of 14 mm (0.56 inches) in the direction of the scan
- Use with MINI-BEAM models 31E, EL, R, RL; and 312D, DBZ, LV, W

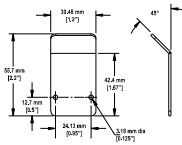

##### RAR300FM

- Front mount right-angle reflector that attaches directly to the threaded barrel of most MINI-BEAMS
- Profile dimension of 34 mm (1.35 inches) in the direction of the scan
- Use with MINI-BEAM models 31E, EL, R, RL; and 312D, LV

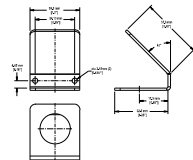

Opposed-mode MINI-BEAM sensors may be fitted with apertures that narrow or shape the effective beam of the sensor to more closely match the size or profile of the object to be sensed, for example, the use of “line” (or “slit”) apertures for sensing wire or thread. Each model contains 20 apertures.

#### MINI-BEAM Opposed-Mode Aperture Kits

Model	Description	Qty
<b>Circular</b>		
AP31-020	0.5 mm dia.	20
AP31-040	1.0 mm dia.	20
AP31-100	2.5 mm dia.	20
<b>Horizontal Slot</b>		
AP31-020H	0.5 x 6.4 mm	20
AP31-040H	1.0 x 6.4 mm	20
AP31-100H	2.5 x 6.4 mm	20
AP31-200H	5.1 x 6.4 mm	20
<b>Vertical Slot</b>		
AP31-020V	0.5 x 12.7 mm	20
AP31-040V	1.0 x 12.7 mm	20
AP31-100V	2.5 x 12.7 mm	20
AP31-200V	5.1 x 12.7 mm	20
<b>Kit</b>		
AP31-DVHX2	2 of each aperture	2

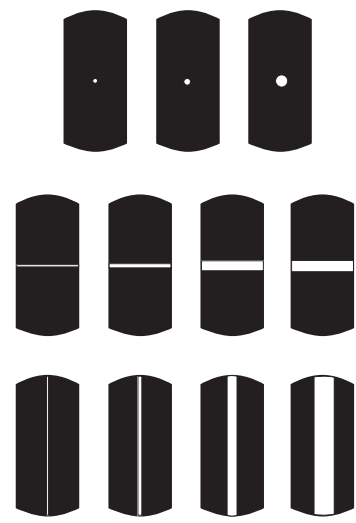

Aperture	Range (Standard Group I and II Sensor Pairs)				Range (Group I Sensor Pairs with UC-300EL Upper Covers Substituted)	
	Aperture on Both Emitter and Received		Aperture on Receiver Only		Aperture on Both Emitter and Received	Aperture on Receiver Only
	Group I Sensors	Group II Sensors	Group I Sensors	Group II Sensors		
AP31-020	89 mm	102 mm	457 mm	1.5 m	127 mm	914 mm
AP31-040	330 mm	457 mm	940 mm	3.2 m	183 mm	2 m
AP31-100	1.5 m	3 m	2.5 m	8.2 m	2.1 m	5.8 m
AP31-020H	406 mm	1.8 m	965 mm	9.1 m	864 mm	3.4 m
AP31-040H	914 mm	4 m	1.8 m	12.5 m	1.8 m	5.2 m
AP31-100H	2.3 m	10.4 m	2.9 m	20.7 m	5.2 m	8.5 m
AP31-200H	2.8 m	21.3 m	3 m	24.4 m	8.2 m	11 m
AP31-020V	457 mm	1.7 m	1 m	8.2 m	1 m	3.4 m
AP31-040V	1 m	5.5 m	1.8 m	15.8 m	2.1 m	5.5 m
AP31-100V	2.3 m	10.7 m	2.9 m	22.9 m	6.1 m	8.5 m
AP31-200V	2.8 m	22.9 m	3 m	25.9 m	8.5 m	11 m

GROUP I Emitter/ Receiver Pairs (see Range): SM31E/SM31R

GROUP II Emitter/ Receiver Pairs (see Range): SM31EL/SM31RL

Example: A MINI-BEAM sensor pair is in Group I. With an AP31-040 circular aperture on the receiver only, range is 940 mm (37 in). With AP31-040 apertures on both emitter and receiver, range is 330 mm (13 in). Group I range with AP31-040 apertures and UC-300EL upper covers on both units is 183 mm; range with receiver aperture only is 2 m (80 in).

## Banner Engineering Corp. Limited Warranty

Banner Engineering Corp. warrants its products to be free from defects in material and workmanship for one year following the date of shipment. Banner Engineering Corp. will repair or replace, free of charge, any product of its manufacture which, at the time it is returned to the factory, is found to have been defective during the warranty period. This warranty does not cover damage or liability for misuse, abuse, or the improper application or installation of the Banner product.

**THIS LIMITED WARRANTY IS EXCLUSIVE AND IN LIEU OF ALL OTHER WARRANTIES WHETHER EXPRESS OR IMPLIED (INCLUDING, WITHOUT LIMITATION, ANY WARRANTY OF MERCHANTABILITY OR FITNESS FOR A PARTICULAR PURPOSE), AND WHETHER ARISING UNDER COURSE OF PERFORMANCE, COURSE OF DEALING OR TRADE USAGE.**

This Warranty is exclusive and limited to repair or, at the discretion of Banner Engineering Corp., replacement. **IN NO EVENT SHALL BANNER ENGINEERING CORP. BE LIABLE TO BUYER OR ANY OTHER PERSON OR ENTITY FOR ANY EXTRA COSTS, EXPENSES, LOSSES, LOSS OF PROFITS, OR ANY INCIDENTAL, CONSEQUENTIAL OR SPECIAL DAMAGES RESULTING FROM ANY PRODUCT DEFECT OR FROM THE USE OR INABILITY TO USE THE PRODUCT, WHETHER ARISING IN CONTRACT OR WARRANTY, STATUTE, TORT, STRICT LIABILITY, NEGLIGENCE, OR OTHERWISE.**

Banner Engineering Corp. reserves the right to change, modify or improve the design of the product without assuming any obligations or liabilities relating to any product previously manufactured by Banner Engineering Corp. Any misuse, abuse, or improper application or installation of this product or use of the product for personal protection applications when the product is identified as not intended for such purposes will void the product warranty. Any modifications to this product without prior express approval by Banner Engineering Corp will void the product warranties. All specifications published in this document are subject to change; Banner reserves the right to modify product specifications or update documentation at any time. Specifications and product information in English supersede that which is provided in any other language. For the most recent version of any documentation, refer to: [www.bannerengineering.com](http://www.bannerengineering.com).

For patent information, see [www.bannerengineering.com/patents](http://www.bannerengineering.com/patents).