

# SPEC Pak®

## 5 Pole Mid Power

- IP68 • Compact Sealed Connector • 3 Phase AC Power Distribution
- Motors & Controls • Industrial Equipment • 60 Amps



**APP**  
Anderson Power Products®

An **IDEAL** Company

## SPECIFICATIONS

### Mechanical

#### Environmental Seal

IEC 60529	IP 68
UL 50E	UL Approved

<b>Wire Size</b>	10 to 8 AWG	6.0 to 8.4 mm <sup>2</sup>
------------------	-------------	----------------------------

#### Operating Temperature

UL 1977	-40 to 105°C	-40 to 221°F
---------	--------------	--------------

<b>Mating Cycles (no load)</b>	250 min
--------------------------------	---------

<b>Mating Force (nominal)</b>	28 lbf	125 N
-------------------------------	--------	-------

<b>Unmating Force</b>	12 lbf	53 N
-----------------------	--------	------

<b>Contact Retention Force (min)</b>	50 lbf	222 N
--------------------------------------	--------	-------

<b>Touch Safe (IEC 60529)</b>	IP 20 (female socket side only)
-------------------------------	---------------------------------

<b>Enclosure Ratings</b>	UL 50 E 4 x 4 *
--------------------------	-----------------

\* Need stainless hardware- type 304 or 316

### Electrical

Current Rating (Amperes)	UL 1977	CSA
10 AWG	45A	30A
8 AWG	60A	40A

#### Voltage Rating

UL 1977 (AC/DC)	600
-----------------	-----

#### Grounding

UL 2238, Sec 37.8	Impedance
-------------------	-----------

<b>Contact Resistance (average)</b>	.300 Milliohms
-------------------------------------	----------------



### Materials

<b>Shell, Housing &amp; Sealing Nut</b>	PC / PBT
---	----------

<b>Lanyard</b>	Nylon / Polyester
----------------	-------------------

<b>Contact Holders</b>	PBT- GF
------------------------	---------

<b>Contact Retention Clip</b>	Be-Cu
-------------------------------	-------

<b>Latch</b>	Stainless Steel
--------------	-----------------

<b>Panel Gasket</b>	NBR
---------------------	-----

<b>Sealing Gland</b>	EPDM
----------------------	------

<b>Flammability</b>	UL94 V-0
---------------------	----------

<b>Glowwire</b>	960°C (GWFI)
-----------------	--------------

	825°F (GWIT)
--	--------------

<b>Weatherability</b>	UL 746C F1
-----------------------	------------

<b>Sockets</b>	Copper
----------------	--------

SC08-GH	Ag plating over Ni
---------	--------------------

SC08-SN	Ag plating over Ni
---------	--------------------

<b>Pins</b>	Copper
-------------	--------

PP08SGH	Ag plating over Ni
---------	--------------------

PC08SSN	Ag plating over Ni
---------	--------------------

Silver = Ag Nickel = Ni

## IEC 61984

### Attributes

<b>AMP Rating AC</b>	60A
----------------------	-----

<b>Voltage Rating AC</b>	800V AC (operational)
--------------------------	-----------------------

<b>Finger Safety **</b>	IEC 60529
-------------------------	-----------

<b>Protection Degree</b>	IP20 Unmated, IP68 Mated
--------------------------	--------------------------

<b>Wire Size Tested</b>	8 AWG
-------------------------	-------

<b>Contact Series Tested</b>	PC08SSN, PP08SGH SC08-SN, SC08-GH
------------------------------	-----------------------------------

<b>Climatic Testing (Cold, Heat &amp; MFG)</b>	IEC 60512 Test -11j, 11i & 11g
--	--------------------------------

<b>Cycle Life</b>	IEC 60512 Test 9A- 5000 Cycles
-------------------	--------------------------------

<b>Mechanical Strength Impact</b>	IEC 60512 @ 29.5 Inches- dropped 8 times
-----------------------------------	---

<b>Temperature Range</b>	-40 to 105°C, -40 to 221°F
--------------------------	----------------------------

### Protection

#### Touch Safety with Finger Proof Housings & Wire Contacts

<b>IEC 60529</b>	IP20 unmated, IP68 mated
------------------	--------------------------

\* In mated and unmated condition, for standard 8 AWG wire contacts (only)

\*\* Female side unmated

### IEC 60950-1

<b>Creepage / Clearance per IEC 60950-1</b>	9.55 (mated or unmated)
---	-------------------------

<b>Material Group</b>	IIIa
-----------------------	------

\* In mated and unmated condition, for standard 8 AWG wire contacts (only)

\*\* Female side unmated

## ORDERING INFORMATION

SPEC Pak® is a highly configurable environmentally sealed connector. For convenience, follow the steps below to determine component part numbers.

### Step 1: Select Shell

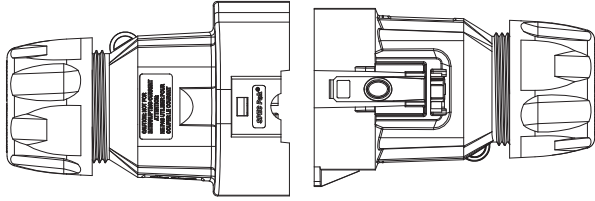

**SK1-076D05**  
Inline Receptacle

**SK6-076D05**  
Plug

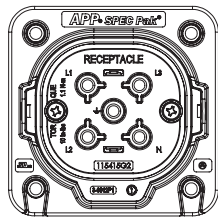

**SK2-076D05**  
Panel Mount Receptacle & Gasket

Description	Part Numbers
Minimum Quantity	25
Inline Receptacle Shell	SK1-076D05
Plug Shell	SK6-076D05
Panel Mount Receptacle	SK2-076D05
Receptacle Cover	SK9-076 (shown on back page)
Plug Cover	SK9P-076 (shown on back page)

- Contact holders are available with multiple keys, please inquire.

### Step 2: Select Sealing Gland

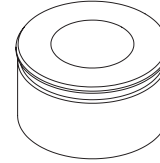

\* Define:

	<u>Number of Wires</u>	<u>Wire OD</u>
Wires		
- Discrete	_____	_____
- Bundled	_____	_____

\* Select wire protection that will accommodate the number of wires and outer diameter (OD) of the wire used in your application.

\* Wire protection is required for use with inline receptacles (SK1-076D05) and plugs (SK6-076D05) to obtain IP68 seal.

Number of Holes	Cable Range Wire Outer Diameter mm (in)	Sealing Grommet Part Number Only
Minimum Quantity		10
1	20.0 mm- 24.0 mm (0.79" - 0.85")	B02130P7

\* For other wire configurations contact manufacturer

### Torque Requirements

Hand tighten. Using a 44 mm wrench or strap wrench, tighten an additional 3/4—1 turn (approximately 7.9 Nm (70 in-lb)).

### Step 3: Select Contacts

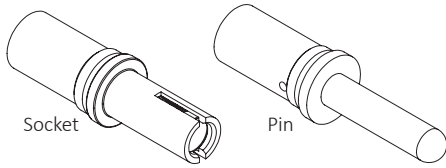

\* Define:

	<u>Number of Circuits</u>	<u>Wire Gauge</u>
Contacts	_____	_____
- Power	_____	_____
- Other	_____	_____

Amps (continuous): \_\_\_\_\_ Max amps at \_\_\_\_\_ Volts

\* Select power and/or ground contacts appropriate for your wire size (AWG or mm<sup>2</sup>).

- Sockets are used in the receptacles (part numbers SK1-076D05 & SK2-076D05)
- Pins are used in the plug (part number SK6-076D05)
- Solid wires not recommended

### TEMPERATURE CHART

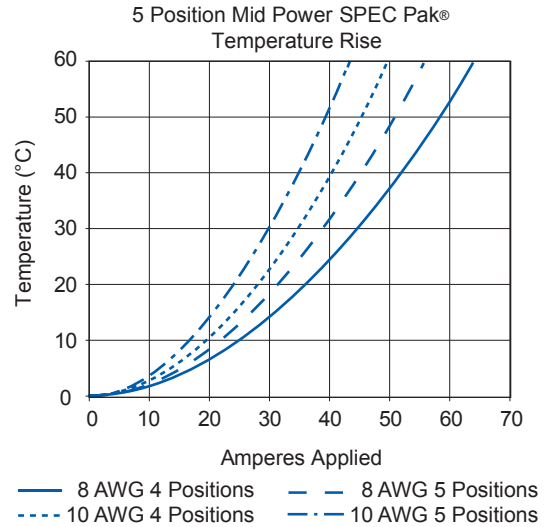

Description	Part Numbers
Minimum Quantity	10
Power Drawer® #8 socket crimp, hot plug/ground	SC08-GH
Power Drawer® #8 socket crimp, standard mate	SC08-SN
Power Drawer® #8 pin crimp, hot plug/ground	PP08SGH
Power Drawer® #8 pin crimp, standard mate	PC08SSN

### TOOLING INFORMATION

Wire Size		Part Number	Crimp Tools									
AWG	MM <sup>2</sup>	Power Contacts	Description	Pneumatic Bench Tool	+	Die	+	Locator	OR	Daniels Manufacturing Tool		
										Tool	Die	Locator
#8/10	8.4/6.0	SC08-GH	POWER DRAWER CONTACT, #8 SOCKET CRIMP, FIRST MATE GROUND							M22520/23-01	M22520/23-2	M22520/23-9
#8/10	8.4/6.0	SC08-SN	POWER DRAWER CONTACT, #8 SOCKET CRIMP, STANDARD MATE	1387G1		1388G6		1389G19		M22520/23-01	M22520/23-2	M22520/23-9
#8/10	8.4/6.0	PP08SGH	POWER DRAWER CONTACT, #8 PIN, CRIMP, STANDARD MATE, FIRST MATE GROUND							M22520/23-01	M22520/23-2	M22520/23-9
#8/10	8.4/6.0	PC08SSN	POWER DRAWER CONTACT, 8.4/6.0 #8, PIN, CRIMP, STANDARD MATE							M22520/23-01	M22520/23-2	M22520/23-9
#8/10	8.4/6.0	M81969/14-06	INSERT AND EXTRACT TOOL									

\* Must contact Daniels directly for this tooling option, [www.dmctools.com](http://www.dmctools.com)



Pneumatic Bench Tool - **1387G1**

Locator - **1389G19**



Die - **1388G6**



Insert & Extract Tool - **M81969/14-06**

# Dimensions

## Plug Mid Power | SK6-076D05

Front View

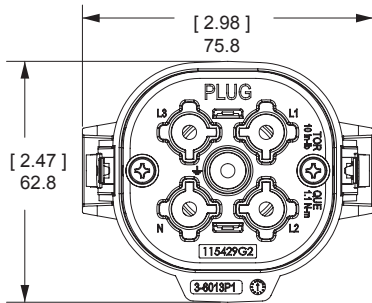

Side View

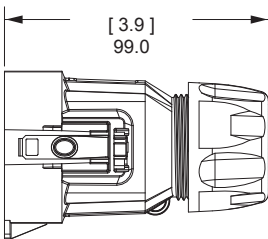

Mated View

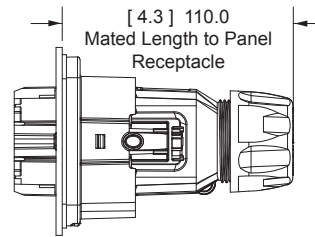

## Panel Mount Receptacle Mid-Power | SK2-076D05

Panel Cut Out

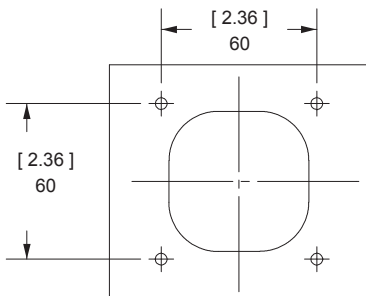

Front View

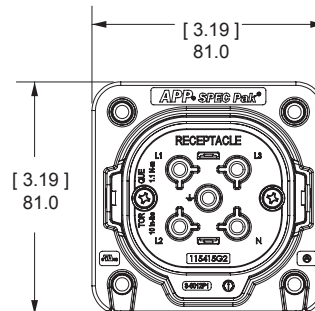

Side View

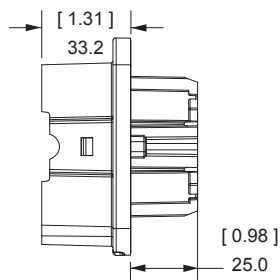

Mated View

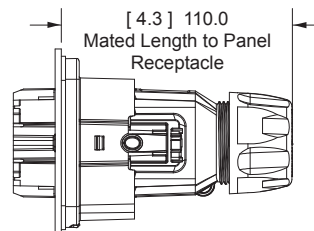

## Inline Receptacle Mid-Power | SK1-076D05

Front View

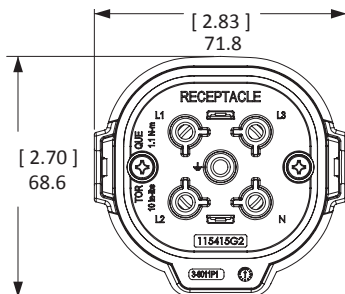

Side View

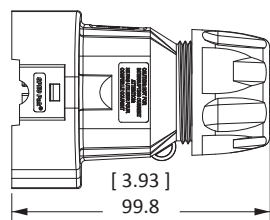

Mated View

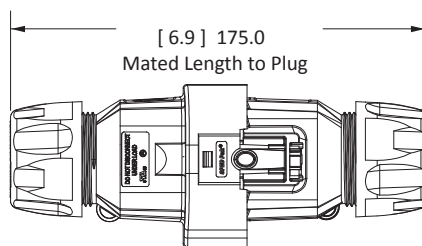

## Plug Cover Kit | SK9P-076

Front View

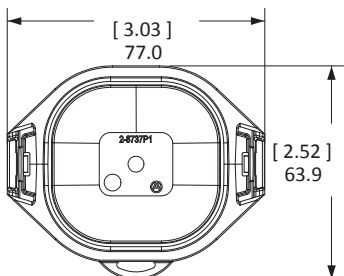

Side View



## Receptacle Cover Kit | SK9-076

Front View

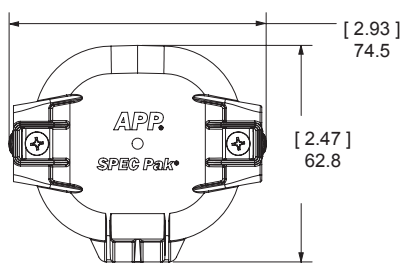

Side View

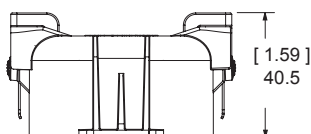

All Data Subject To Change Without Notice 2019-0161 DS-MPSPAK5P REV 2

Anderson will use reasonable efforts to include accurate and up-to-date content in the data sheet. All product information contained in the data sheet including ordering information, illustrations, specifications, and dimensions, are believed to be reliable as of the date of publishing, but is subject to change without notice. Anderson makes no warranty or representation as to its accuracy. Content in the data sheet may contain technical inaccuracies, typographical errors and may be changed or updated without notice. Anderson™ may also make improvements and/or changes to the products and/or to the programs described in the content at any time without notice. Current sales drawings and specifications are available upon request.

© 2019 Anderson Power Products, Inc. All rights reserved. SPEC Pak®, Power Drawer®, APP®, A®, Anderson Power Products® and the APP logo are registered trademarks of Anderson Power Products, Inc.



**HEADQUARTERS:** Anderson Power Products®, 13 Pratts Junction Road, Sterling, MA 01564-2305 USA T:978-422-3600 F:978-422-0128 • **EUROPE:** Anderson Power Products® Ltd., Unit 3, Europa Court, Europa Boulevard, Westbrook, Warrington, Cheshire, WA5 7TN United Kingdom T: +44 (0) 1925 428390 F: +44 (0) 1925 520203 • **ASIA / PACIFIC:** IDEAL Anderson Asia Pacific Ltd., Unit 922-928 Topsail Plaza, 11 On Sum Street, Shatin N.T., Hong Kong T: +(852) 2636 0836 F: +(852) 2635 9036 • **CHINA:** IDEAL Anderson Technologies (Shenzhen) Ltd., Block A8 Tantou Western Industrial Park, Songgang Baoan District, Shenzhen, PR. China 518105 T: +(86) 755 2768 2118 F: +(86) 755 2768 2218 • **TAIWAN:** IDEAL Anderson Asia Pacific Ltd., Taiwan Branch, 4F.-2, No.116, Dadun 20th St., Situn District, Taichung City 407, Taiwan (R.O.C.) T: +(886) 4 2310 6451 F: +(886) 4 2310 6460 • [www.andersonpower.com](http://www.andersonpower.com)