

# SB®120 Connectors - up to 240 Amps

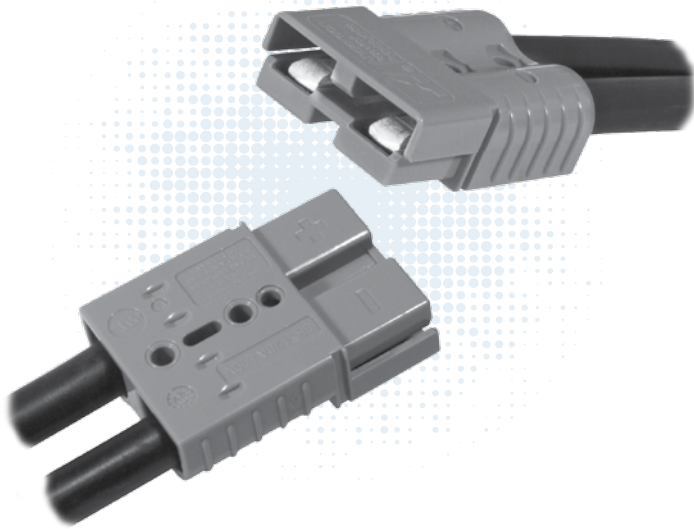

Like the other Multipole connectors, the SB®120 offers color-coded mechanically keyed housings. Keys can be used to identify and separate different circuits, or prevent users from accidentally cross mating different voltages. Wires sizes from #10 (5.3 mm<sup>2</sup>) to #1 (42.4 mm<sup>2</sup>) are held in the second smallest SB® housing.

- **New extended range contacts expand wire size up to #1 AWG (42.4 mm<sup>2</sup>)**  
*Allows UL rated currents up to 240 amps*
- **Chemical resistant housing option**  
*Extends temperature range down to -40°C, while offering enhanced UV and chemical resistance*
- **Panel mounting grooves**  
*With use of mounting clamps, can be easily mounted through panels*

SECTION 3  
SB® 120

## | SB®120 ORDERING INFORMATION |

### SB®120 Standard Housings

The second to smallest SB® housings work with wire contacts up to 1 AWG [35 mm<sup>2</sup>] as well as busbar contacts. Genderless design mates with itself. Mechanical keys are color coded.

Description	----- Part Numbers -----	
Minimum Quantity .....	250	50 ....
Red	6810G3-BK	6810G3
Gray	6810G1-BK	6810G1
Blue	6810G2-BK	6810G2

### SB®120 Chemical Resistant (CR) Housings

Same features as the Standard SB®120 but molded in a chemical resistant PBT/ PC blend. Suitable for use to -40°C.

Description	----- Part Numbers -----	
Minimum Quantity .....	250	50 ....
Red	P6810G3-BK	P6810G3
Gray	P6810G1-BK	P6810G1

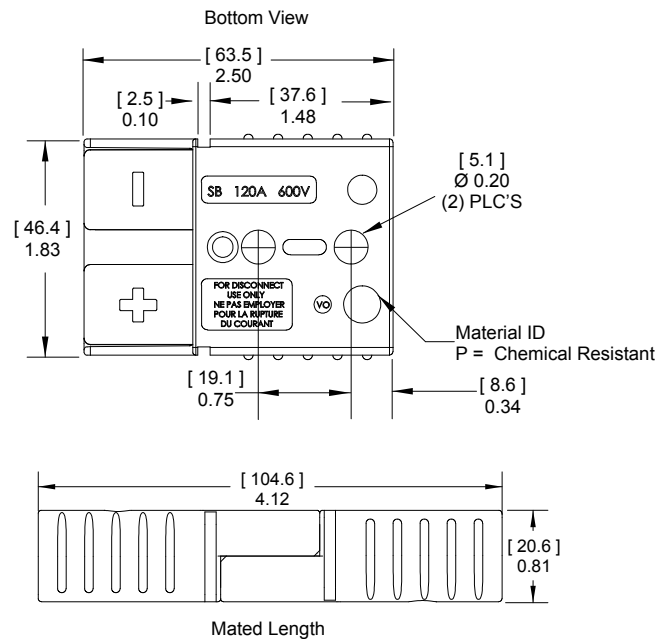

### SB®120 Silver Plated Wire Contacts

Silver plated contacts offer superior electrical performance and durability up to 10,000 mating cycles. See reducing bushings in accessory section for smaller wires.

AWG	mm <sup>2</sup>	Mating Force	----- Loose Piece Part Numbers -----			Dimensions			
						- A -		- B -	
Minimum Quantity .....			600	500	50	inches	mm	inches	mm
1	42.4	Low	1323G1-BK	-	1323G1	0.47	11.94	0.39	9.91
2	33.6	High	-	1319-BK	1319	0.44	11.18	0.34	8.64
4	21.1	High	-	1319G4-BK	1319G4	0.44	11.18	0.29	7.37
6	13.3	High	-	1319G6-BK	1319G6	0.44	11.18	0.22	5.59

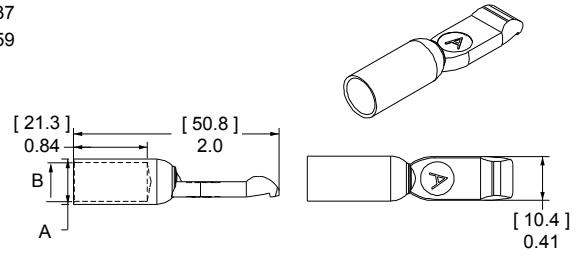

### SB®120 Silver Plated Busbar Contacts

Use 2 busbar contacts per housing to provide a quick disconnect input or output busbar connection. Busbar contacts are for mating with wire contacts only. Part number 120BBS includes lock nuts. Locknuts must be ordered separately for B01997P1.

Type	Thread	Mating Force	----- Loose Piece Part Numbers -----			
Minimum Quantity .....			1,000	300	20	10 ...
Busbar	#10-24	High	-	B01997P1	-	120BBS
Lock Nut	#10-24	-	H1216P8	-	110G54	-

See Busbar contact drawing on website for further detail.

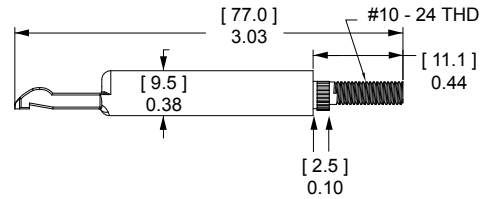

# SB®120 CONNECTOR SPECIFICATIONS |

Electrical		
<b>Current Rating Amperes <sup>1</sup></b>	<b>UL 1977</b>	<b>CSA</b>
Wire to Wire (1 AWG)	240	130
Wire to Busbar (2 AWG)	120	
<b>Voltage Rating AC/DC</b>		
UL 1977	600	
<b>Dielectric Withstanding Voltage</b>		
Volts AC	2,200	
<b>Avg. Mated Contact Resistance Milliohms <sup>1</sup></b>		
5 1/2" of #2 AWG wire	0.136	
<b>Hot Plug Current Rating Amperes - Wire &amp; Busbar</b>		
250 cycles at 120V DC	60A	

Mechanical		
<b>Wire Size Range</b>	<b>AWG</b>	<b>mm<sup>2</sup></b>
Wire Contacts with Bushings	10 - 1	5.3 - 42.4
<b>Max. Wire Insulation Diameter</b>	<b>in.</b>	<b>mm</b>
	0.600	15.240
<b>Operating Temperature <sup>2</sup></b>	<b>°F</b>	<b>°C</b>
Standard	-4° to 221°	-20° to 105°
Chemical Resistant*	-40 to 221°	-40° to 105°
<b>Mating Cycles No Load by Plating</b>	<b>Silver (Ag)</b>	
Wire and Busbar Contacts	10,000	
<b>Avg. Mating / Unmating Force</b>	<b>Lbf.</b>	<b>N</b>
Wire to Wire	20	89
<b>Min. Contact / Spring Retention Force</b>		
lbf	75	
N	333.6	

Materials	
<b>Housing</b>	
Standard Plastic Resin	Polycarbonate
Chem. Resistant Resin	Polycarbonate / PBT blend
Contact Retention Spring	Stainless Steel
<b>Housing Flammability Rating</b>	
UL94	V-0
Glow Wire	960°C (GWFI) / 800°C (GWIT)
<b>Wire &amp; Busbar Contacts</b>	
Base	Copper Alloy
Plating	Silver
<b>Contact Termination Methods</b>	
Crimp <sup>3</sup>	Wire Contacts
Hand Solder	Wire Contacts
Wrench / Socket	Busbar Contacts Only

Connector Series	Configurations	Creepage/Clearance per IEC 60950-1	Material Group
SB®120	Unmated	4.10 mm	IIla
	Mated	4.10 mm	

Protection	
<b>Touch Safety with Wire Contacts</b>	
IEC 60529	IP10
<b>Environmental Sealing with Boots</b>	
IEC 60529	IP64

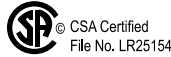

NOTE 1: See IEC 60664-1 for working voltage.

NOTE 2: Amp ratings are stated per position and based on all positions being fully loaded.

<sup>1</sup> Based on: 105°C rated or better cable of the largest size, Properly calibrated APP recommended tooling, and a 25°C ambient temperature. UL rating not to exceed the maximum operating temperature. CSA rating below a 30°C temperature rise.

<sup>2</sup> Limited by the thermal properties of the connector plastic housing.

<sup>3</sup> Use APP recommended tooling only. Alternate tools may adversely affect the performance of our connectors along with UL and CSA recognition.

SECTION 3  
SB® 120

# SB®120 CONNECTOR TEMPERATURE CHARTS | Temperature rise charts are based on a 25°C ambient temperature.

For Temperature Rise Above 60°C, Consult the Extended Temperature Rise Charts in the Appropriate Product Section on the Website.

Current - Temperature Derating per IEC 60512-5-2 Test 5B

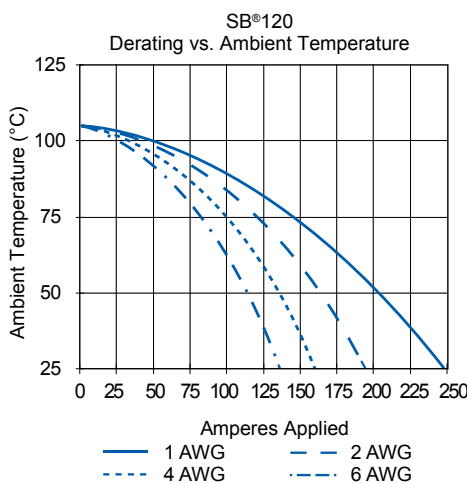
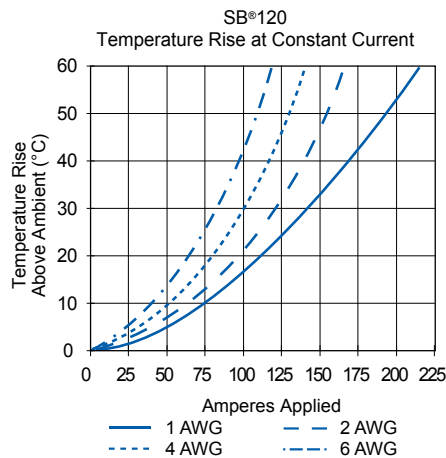

# | SB® 120 Accessories |

## Mounting Clamp for SB®120

Mounting clamps can be used for fastening a SB®120 series housings to a panel. Fastening hardware not included.

Description	--- Part Number ---
Minimum Quantity .....	20 sets of 2 .....
Panel Mount Bracket	1467G1

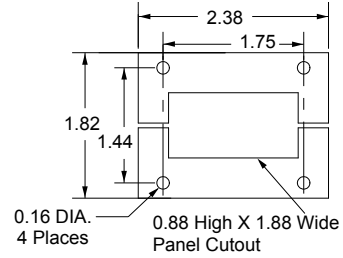

## Cable Clamps

Durable metal cable clamps securely hold cables to prevent accidental strain or pulls from dislodging wire or contacts from the housing. Cable clamps are recommended for solder terminated wires.

Description	Cable Size		- Part Numbers -
	Min / Max Inches O.D.	Min / Max mm O.D.	
Minimum Quantity .....			50 .....
Bolt on for Discrete Conductor	0.70 to 0.23	17.7 to 5.8	981G1
Bolt on for Bundled Conductor	0.73 to 0.29	18.5 to 7.3	981G2

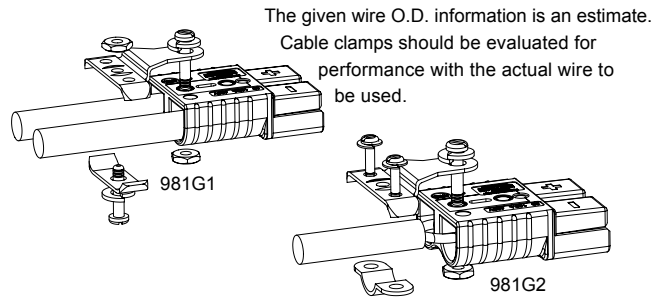

## “A” Frame Handle for SB®120

Handle makes mating and unmating the connector easier. The non-conductive gray plastic material is strong and safe. Machine screws and locknuts included.

Description	- Part Number -
Minimum Quantity .....	200 .....
Gray “A” Handle & Hardware	997G1

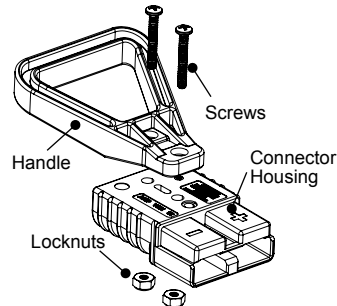

## “T” Handle

The “T” handle makes mating and unmating the connector easier. The non-conductive red plastic material is strong and safe. (2) Self tapping screws are used to secure the handle to the connector housing.

Description	----- Part Numbers -----	
Minimum Quantity .....	1,000	50 .....
Red “T” Handle + Hardware Bag	-	SB120-HDL-RED
Red “T” Handle Only	113899P1	-
#8 x 7/8” Screw (Order 2 Per Handle)	H1120P43	-

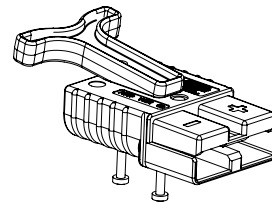

### Dust Cover

Prevents dust and dirt from entering the mating interface of the connector when unmated. NOTE: Not a Hermetic Seal.

Description	----- Part Numbers -----		
Minimum Quantity .....	100	50	...
Dust Cover with Lanyard Strap, Black	B02019P1	134G4	

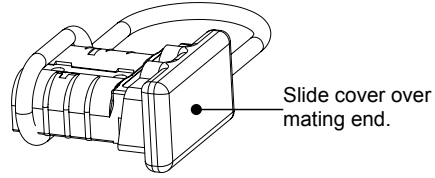

### SB® Environmental Boots

SB® Environmental Boots provide water, dirt, chemical and UV protection for SB®120 connectors. The durable boots shield the connectors from water and dirt to IP64 in both the mated and unmated condition.

Description	----- Part Number -----	
Minimum Quantity .....	250	25 ..
SB®120 Environmental Boot, Load	3-6035P1-BK	3-6035P1
SB®120 Environmental Boot, Source	3-6034P1-BK	3-6034P1

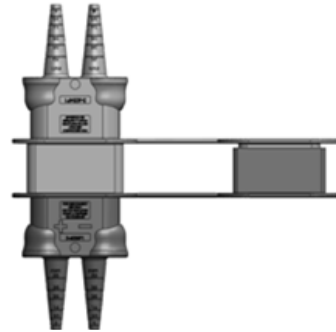

### Reducing Bushings

Use with contact part number 1319-BK to allow a smaller wire to be used with the connector. Electrical capability is derated with smaller wire.

Contact Barrel Size	Wire Size	----- Part Numbers -----			Dimensions - ID -	
					inches	mm
Minimum Quantity .....		2,000	1,000	100		
#2 AWG [33.6 mm <sup>2</sup> ]	#4 AWG [21.2 mm <sup>2</sup> ]	5919-BK	-	5919	0.28	7.11
#2 AWG [33.6 mm <sup>2</sup> ]	#6 AWG [16 mm <sup>2</sup> ]	-	5920-BK	5920	0.23	5.84
#2 AWG [33.6 mm <sup>2</sup> ]	#10 - 8 AWG [5.3 - 8.4 mm <sup>2</sup> ]	5921-BK		5921	0.18	4.57

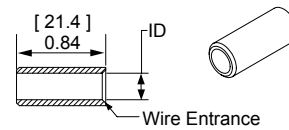

**- Tooling Information**

Wire Size		Loose Piece Part Numbers	Loose Piece Contact Crimp Tools				Number of Crimps
AWG	mm²	Silver Plating	Hand Tool	Pneumatic Bench Tool	Die	Locator	
<b>SB®50</b>							
#6	13.3	1307 5900	1309G4	1387G1	1388G6	1389G6	Single
#8	8.4	5952			1388G7	1389G7	
#10 / 12	5.3 / 3.3	5953 5915					
<b>SB®120</b>							
#1	42.4	1323G1	1368 Series	1387G1	1388G3	1389G4	Single
#2	33.6	1319			1388G4		
#4	21.2	1319G4					
#6	13.3	1319G6					
<b>SB®175</b>							
1/0	53.5	1382	1368 Series	1387G2	1303G13	1304G32	Double
#1	42.4	1347					
#2	33.6	1383					
#4	21.1	1384					
#6	13.3	1348					
<b>SB®350</b>							
300mcm	152	910	1368 Series	1387G2	N/A		Double
4/0	107.2	908			1303G3	1304G31	
3/0	85	916			1303G12		
2/0	67.4	907					
1/0	53.5	917					

NOTE: See website for the most current information.

SECTION 3  
SB®