

Quick Start Guide

Radar-Based Sensors for Detection and Measurement of Moving and Stationary Targets. Patent pending.

This guide is designed to help you set up and install the R-GAGE K50R sensor. For complete information on programming, performance, troubleshooting, dimensions, and accessories, please refer to the Instruction Manual at www.bannerengineering.com. Search for p/n 226219 to view the Instruction Manual. Use of this document assumes familiarity with pertinent industry standards and practices.



WARNING:

- **Do not use this device for personnel protection**
- Using this device for personnel protection could result in serious injury or death.
- This device does not include the self-checking redundant circuitry necessary to allow its use in personnel safety applications. A device failure or malfunction can cause either an energized (on) or de-energized (off) output condition.

Overview

The K50R is an industrial radar sensor that uses high frequency radio waves from an internal antenna.

Figure 1. Sensing Range

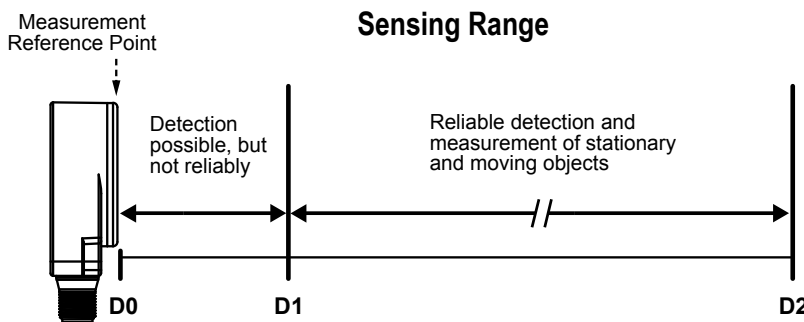

Model	D0 (m)	D1 (m)	D2 (m)
K50RxF-8060-LDQ	0	0.1	2.5

Features and Indicators

K50R Standard—Features



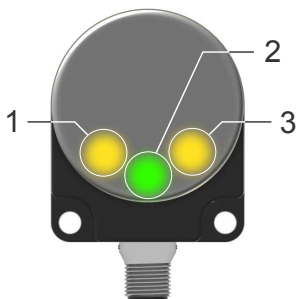

Figure 2. K50RF-8060-LDQ Features



	LED	Color	Description
1	Output 1	Amber	Discrete output status
2	Power/Signal Strength	Green or Blue	Power ON and signal strength indication
3	Output 2	Amber	Discrete output status

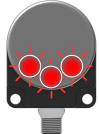

K50R Standard—Signal Strength and the Indicator LEDs

LED	Color	Description	LED	Color	Description
	ON Green	Power ON Signal strength is greater than 2x the user-selected threshold		ON Amber	Discrete output 1 status
	Flashing Green	Power ON Signal strength is less than 2x the user-selected threshold		ON Amber	Discrete output 2 status
	ON Blue	Power ON Signal strength is less than 1		Flashing Red	Error

K50R Pro—Features

Figure 3. K50RPF-8060-LDQ Features



The Pro models offer advanced indication of distance thresholds and device states. Options include animation, intensity, patterns, colors, and others.

See the instruction manual for configuration information and instructions.

If all LEDs flash red continually, the sensor is in an error state.

Installation Instructions

Install the Software

Operating System

Microsoft® Windows® operating system version 10 ¹

Hard Drive Space

500 MB

Third-Party Software

.NET

USB Port

Available USB port



Important: Administrative rights are required to install the Banner Radar Configuration software.

1. Download the latest version of the software from www.bannerengineering.com/us/en/products/sensors/software/radar-configuration.html.
2. Navigate to and open the downloaded file.
3. Click **Install** to begin the installation process.
4. Depending on your system settings, a popup window may appear prompting to allow Banner Radar Configuration to make changes to your computer. Click **Yes**.
5. Click **Close** to exit the installer.

Mount the Device

1. If a bracket is needed, mount the device onto the bracket.

¹ Microsoft and Windows are registered trademarks of Microsoft Corporation in the United States and/or other countries.

2. Mount the device (or the device and the bracket) to the machine or equipment at the desired location. Do not tighten the mounting screws at this time.
3. Check the device alignment.
4. Tighten the mounting screws to secure the device (or the device and the bracket) in the aligned position.

Connect to the Sensor

Figure 4. System Components for a Typical Installation

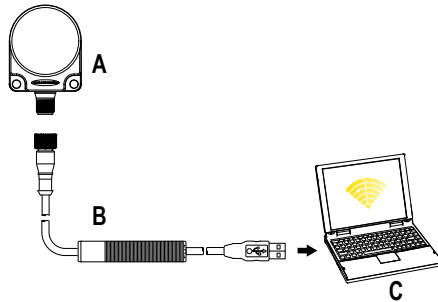

- A = K50R
- B = Pro Converter Cable (MQDC-506-USB)
- C = PC running Banner Radar Configuration software

Note: Requires a PC USB port to supply 0.5 A at 5 V.

Wiring

Quick disconnect wiring diagrams are functionally identical.

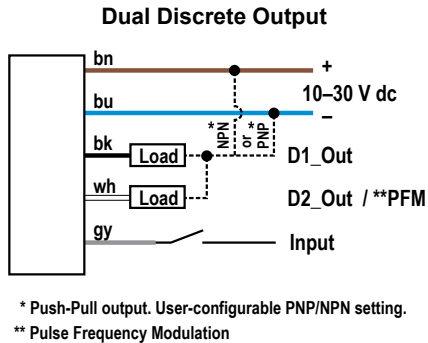

Key:

- 1 = Brown
- 2 = White
- 3 = Blue
- 4 = Black
- 5 = Gray (Connect for use with remote input or Banner Radar Configuration software)

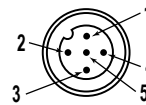

Note: A shielded cable is required if the sensor is mounted outdoors or if the cable is longer than 30 m (98.4 ft).

Getting Started

Power up the sensor, and verify that the power LED is ON green.

Connect to the Sensor

1. Connect the sensor to the Pro Cable.
2. Connect the Pro Converter cable to the PC.
3. Open the Banner Radar Configuration Software.
4. Go to **Sensor > Connect** on the **Navigation** toolbar. The **Connection** screen displays.
5. Select the correct **Sensor Model** and **Com Port** for the sensor.
6. Click **Connect**. The **Connection** screen closes and the sensor data displays.

Software Overview

Easy setup and configuration of range, sensitivity, and output using the Banner Radar Configuration software and Pro Converter Cable.

Figure 5. Banner Radar Configuration Software

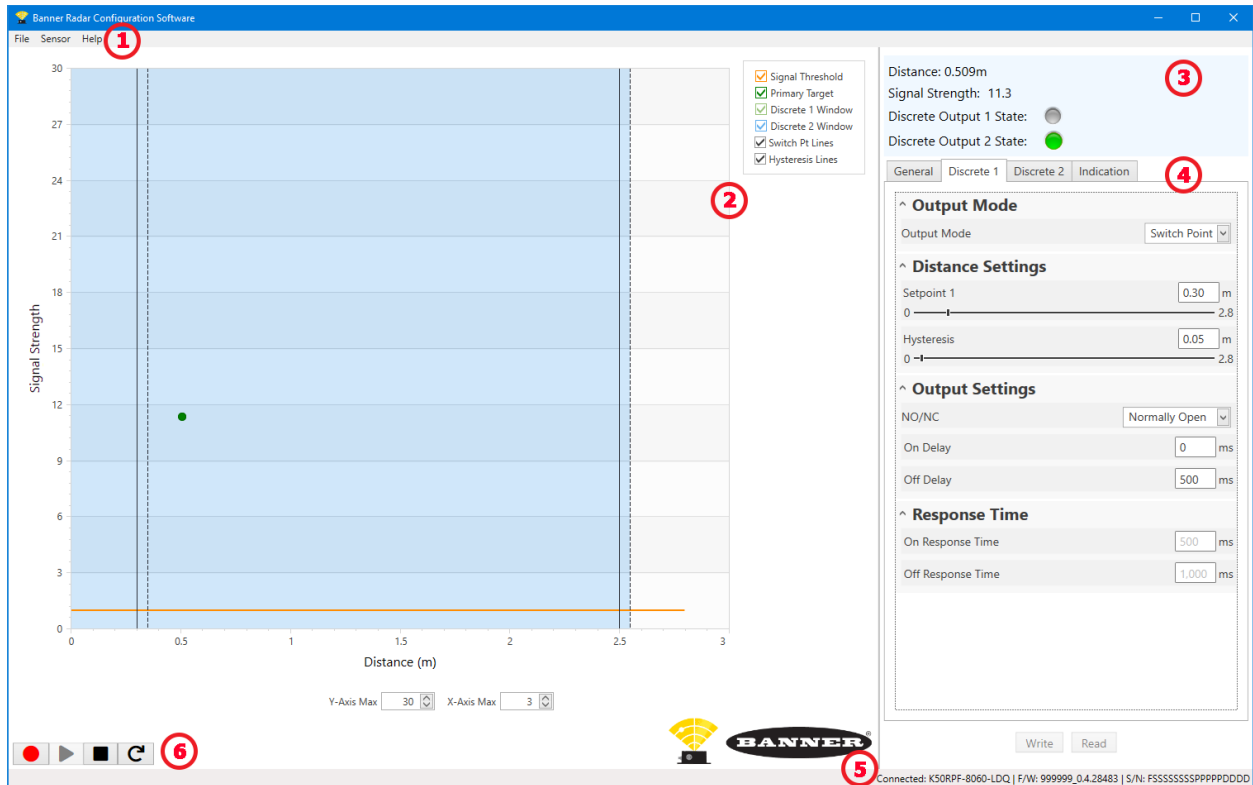

1. Navigation toolbar—Use this toolbar to connect to the sensor, to save or load a configuration, or to reset to factory defaults
2. Live Sensor Data and Legend—Shows the signal strength versus distance for the connected sensor, as well as options to select which data displays on the graph
3. Summary pane—Displays the distance to the target, the signal strength, and the output status
4. Sensor Settings pane—Set the sensor parameters in this pane
5. Status bar—Shows whether the sensor is connected, if a software update is available, and if the sensor data is being recorded to a file
6. Live Sensor Data controls—Use these controls to record, freeze, and play real-time sensor data, and to refresh the sensor connection

Specifications

Range

The sensor can detect an object at the following ranges, depending on the material of the target: 100 mm to 2.5 m

Operating Principle

Pulsed coherent radar (PCR)

Operating Frequency

60.5 GHz

Supply Voltage (Vcc)

10 V DC to 30 V DC

Use only with a suitable Class 2 power supply (UL) or Limited Power Supply (CE)

Power and Current Consumption, exclusive of load

Standard models:

Power consumption: <1.0 W at 24 V

Current consumption: <35 mA at 24 V

Pro models:

Power consumption: <1.5 W at 24 V

Current consumption: <55 mA at 24 V

Supply Protection Circuitry

Protected against reverse polarity and transient overvoltages

Linearity

< ± 2 mm from 100 mm to 250 mm

< ± 4 mm from 250 mm to 800 mm

< ± 8 mm from 800 mm to 2.5 m

Reference target with RCS = 1m²

Delay at Power-up

< 1 s

Output Configuration

Discrete Output 1 (Black Wire): Configurable PNP or NPN output

Discrete Output 2 (White Wire): Configurable PNP or NPN output or Pulse Frequency Modulated (PFM) output

Output Ratings

Current rating = 50 mA maximum each

Black wire specifications per configuration		
PNP	Output High	≥ Vsupply - 2.5 V
	Output Low	≤ 1V (loads ≤ 1 MegΩ)
NPN	Output High	≥ Vsupply - 2.5 V
	Output Low	≤ 2.5 V

White wire specifications per configuration		
PNP	Output High	≥ Vsupply - 2.5 V
	Output Low	≤ 2.5 V (loads ≤ 70 kΩ)
NPN	Output High	≥ Vsupply - 2.5 V
	Output Low	≤ 2.5 V

Repeatability ²

4 mm from 100 to 250 mm

8 mm from 250 mm to 800 mm

16 mm from 800 mm to 2.5 m

Maximum Output Power

EIRP: 10dBm

Output Protection

Protected against output short-circuit

Remote Input

Allowable Input Voltage Range: 0 to Vsupply

Active High (internal weak pull-down): High state > (Vsupply - 2.25 V) at 2 mA maximum

Active Low (internal weak pull-up): Low state < 2.25 V at 2 mA maximum

Response Time

Discrete output response: 200 ms

Speeds given for fast mode. See the Instruction Manual for additional details.

Indicators

Standard models:

Power LED/Signal Strength: Green or blue depending on sensor state

Output LEDs: Amber, target within taught discrete output status

Pro models: User configurable

Construction

Housing: Polycarbonate

Window: Polycarbonate

Connections

Integral M12 quick disconnect

Models with a quick disconnect require a mating cordset



Note: A shielded cable is required if the sensor is mounted outdoors or if the cable is longer than 30 m (98.4 ft).

Vibration and Mechanical Shock

All models meet MIL-STD-202F, Method 201A (Vibration: 10 Hz to 60 Hz maximum, 0.06 inch (1.52 mm) double amplitude, 10G acceleration) requirements. Method 213B conditions H&I.Shock: 75G with device operating; 100G for non-operation

Operating Temperature

Standard model: -40 °C to +60 °C (-40 °F to +140 °F)

Temperature Effect

<±5 mm from -40 °C to +60 °C (-40 °F to +140 °F)

Environmental Rating

IP67

Certifications



Banner Engineering Europe Park Lane, Culliganlaan 2F bus 3, 1831 Diegem, BELGIUM

Turck Banner LTD Blenheim House, Blenheim Court, Wickford, Essex SS11 8YT, Great Britain

Contains FCC ID: 2AQ6KA1001

Contains IC: 24388-A111

for others, contact Banner Engineering

Advanced Capabilities



Country of Origin

USA

FCC Part 15 Class A

This equipment has been tested and found to comply with the limits for a Class A digital device, pursuant to part 15 of the FCC Rules. These limits are designed to provide reasonable protection against harmful interference when the equipment is operated in a commercial environment. This equipment generates, uses, and can radiate radio frequency energy and, if not installed and used in accordance with the instruction manual, may cause harmful interference to radio communications. Operation of this equipment in a residential area is likely to cause harmful interference in which case the user will be required to correct the interference at his own expense.

² At medium response speed.

Industry Canada

Contains IC: 24388-A111—This device contains licence-exempt transmitters(s)/receiver(s) that comply with Innovation, Science and Economic Development Canada’s licence-exempt RSS(s). Operation is subject to the following two conditions:

1. This device may not cause interference.
2. This device must accept any interference, including interference that may cause undesired operation of the device.

Cet appareil contient des émetteurs/récepteurs exemptés de licence conformes à la norme Innovation, Sciences, et Développement économique Canada. L’exploitation est autorisée aux deux conditions suivantes:

1. L’appareil ne doit pas produire de brouillage.
2. L’utilisateur de l’appareil doit accepter tout brouillage radioélectrique subi, même si le brouillage est susceptible d’en compromettre le fonctionnement.

Beam Patterns

The beam pattern of the radar sensor is dependent on the radar cross section (RCS) of the target.

The beam pattern graphs are guides for representative object detection capabilities based on different sized radar cross sections and corresponding example real world targets. Use the following charts as a starting point in application setup. Note that applications vary.

- Use the Beam Width versus Distance chart to understand where corresponding objects can be detected. Adjusting the signal strength threshold also affects the beam pattern when the target is constant.
- Use the Beam Width versus Degrees chart to help determine how much the target can tilt from 90 degrees while still maintaining detection.

Unless otherwise specified, the following beam patterns are shown with Signal Strength Threshold = 1.

Figure 6. Typical beam pattern, in millimeters, on representative targets

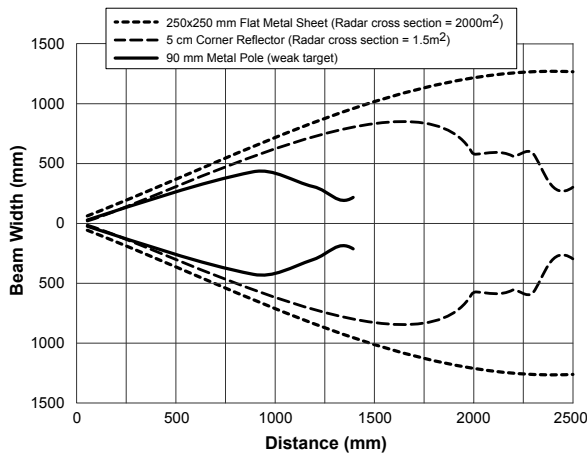

Figure 7. Typical beam pattern, in degrees, on representative targets

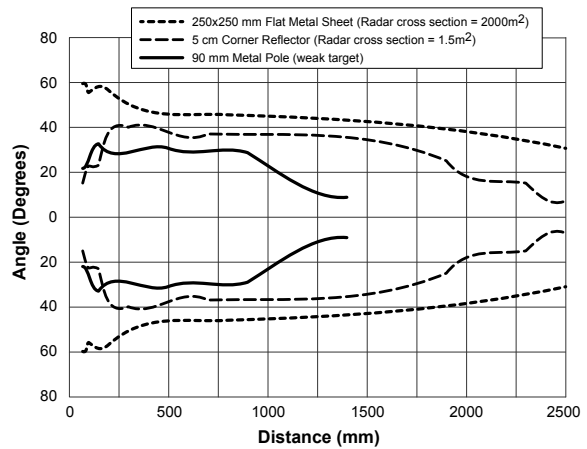

Figure 8. Typical beam pattern, in millimeters, with 250 × 250 mm Flat Metal Sheet (Radar cross section = 2000m²) and various signal strength thresholds

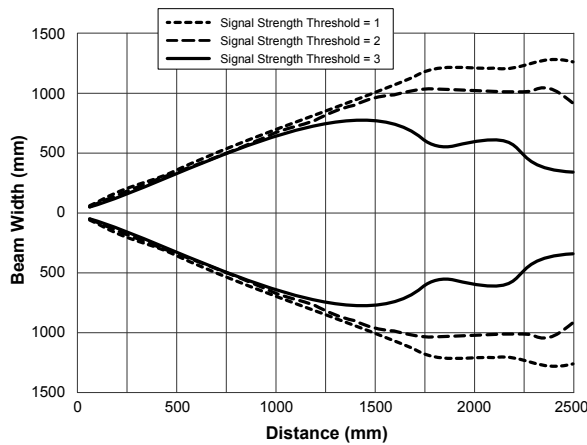
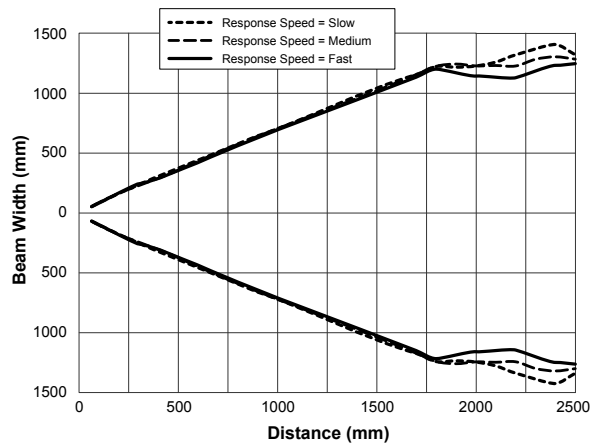

Figure 9. Typical beam pattern, in millimeters, with 250 × 250 mm Flat Metal Sheet (Radar cross section = 2000m²) and various response speeds



Banner Engineering Corp. Limited Warranty

Banner Engineering Corp. warrants its products to be free from defects in material and workmanship for one year following the date of shipment. Banner Engineering Corp. will repair or replace, free of charge, any product of its manufacture which, at the time it is returned to the factory, is found to have been defective during the warranty period. This warranty does not cover damage or liability for misuse, abuse, or the improper application or installation of the Banner product.

THIS LIMITED WARRANTY IS EXCLUSIVE AND IN LIEU OF ALL OTHER WARRANTIES WHETHER EXPRESS OR IMPLIED (INCLUDING, WITHOUT LIMITATION, ANY WARRANTY OF MERCHANTABILITY OR FITNESS FOR A PARTICULAR PURPOSE), AND WHETHER ARISING UNDER COURSE OF PERFORMANCE, COURSE OF DEALING OR TRADE USAGE.

This Warranty is exclusive and limited to repair or, at the discretion of Banner Engineering Corp., replacement. **IN NO EVENT SHALL BANNER ENGINEERING CORP. BE LIABLE TO BUYER OR ANY OTHER PERSON OR ENTITY FOR ANY EXTRA COSTS, EXPENSES, LOSSES, LOSS OF PROFITS, OR ANY INCIDENTAL, CONSEQUENTIAL OR SPECIAL DAMAGES RESULTING FROM ANY PRODUCT DEFECT OR FROM THE USE OR INABILITY TO USE THE PRODUCT, WHETHER ARISING IN CONTRACT OR WARRANTY, STATUTE, TORT, STRICT LIABILITY, NEGLIGENCE, OR OTHERWISE.**

Banner Engineering Corp. reserves the right to change, modify or improve the design of the product without assuming any obligations or liabilities relating to any product previously manufactured by Banner Engineering Corp. Any misuse, abuse, or improper application or installation of this product or use of the product for personal protection applications when the product is identified as not intended for such purposes will void the product warranty. Any modifications to this product without prior express approval by Banner Engineering Corp will void the product warranties. All specifications published in this document are subject to change; Banner reserves the right to modify product specifications or update documentation at any time. Specifications and product information in English supersede that which is provided in any other language. For the most recent version of any documentation, refer to:

www.bannerengineering.com.

For patent information, see www.bannerengineering.com/patents.

Banner Engineering Corp. Software Copyright Notice

This software is protected by copyright, trade secret, and other intellectual property laws. You are only granted the right to use the software and only for the purposes described by Banner. Banner reserves all other rights in this software. For so long as you have obtained an authorized copy of this software directly from Banner, Banner grants you a limited, nonexclusive, nontransferable right and license to use this software.

You agree not to use, nor permit any third party to use, this software or content in a manner that violates any applicable law, regulation or terms of use under this Agreement. You agree that you will not reproduce, modify, copy, deconstruct, sell, trade or resell this software or make it available to any file-sharing or application hosting service.

Disclaimer of Warranties. Your use of this software is entirely at your own risk, except as described in this agreement. This software is provided "AS-IS." To the maximum extent permitted by applicable law, Banner, its affiliates, and its channel partners disclaim all warranties, expressed or implied, including any warranty that the software is fit for a particular purpose, title, merchantability, data loss, non-interference with or non-infringement of any intellectual property rights, or the accuracy, reliability, quality or content in or linked to the services. Banner and its affiliates and channel partners do not warrant that the services are secure, free from bugs, viruses, interruption, errors, theft or destruction. If the exclusions for implied warranties do not apply to you, any implied warranties are limited to 60 days from the date of first use of this software.

Limitation of Liability and Indemnity. Banner, its affiliates and channel partners are not liable for indirect, special, incidental, punitive or consequential damages, damages relating to corruption, security, loss or theft of data, viruses, spyware, loss of business, revenue, profits, or investment, or use of software or hardware that does not meet Banner minimum systems requirements. The above limitations apply even if Banner and its affiliates and channel partners have been advised of the possibility of such damages. This Agreement sets forth the entire liability of Banner, its affiliates and your exclusive remedy with respect to the software use. You agree to indemnify and hold Banner and its affiliates and channel partners harmless from any and all claims, liability and expenses, including reasonable attorney's fees and costs, arising out of your use of the Services or breach of this Agreement (collectively referred to as "Claims"). Banner reserves the right at its sole discretion and at its own expense, to assume the exclusive defense and control of any Claims. You agree to reasonably cooperate as requested by Banner in defense of any Claims.



more sensors, more solutions