

CATIA V5

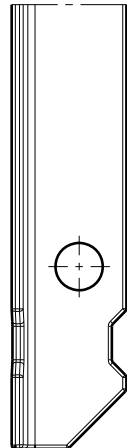

Revision Level			Revision Record	Changed	Date	Approved	Date
Drawing	State	Part					
00.1	Design Release		SEE ECN# 015295	CJR	7/17/19	KVH	7/17/19

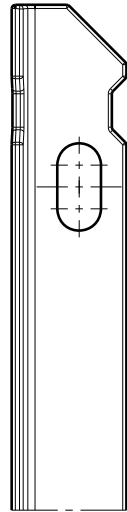
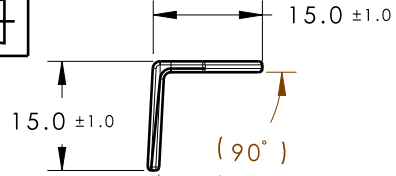
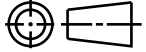
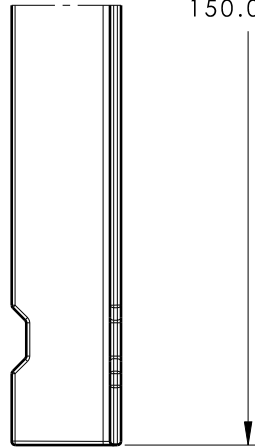
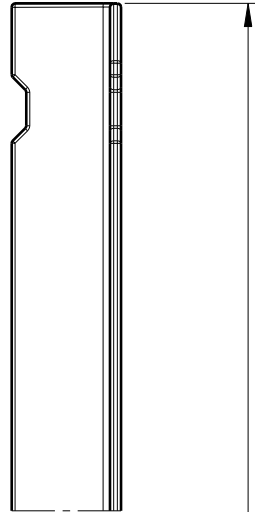

150.0 ±2.0

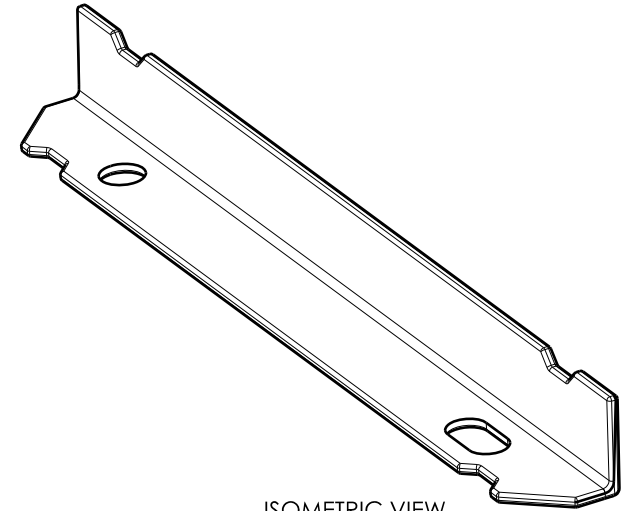

ISOMETRIC VIEW



BOTTOM VIEW (1/2)

Material  
PP20%TC  
COLOR: BLACK

Units **millimeters**  
  
Tolerance defined on each dimension

The copyright of this drawing is reserved by HellermannTyton. It is issued on condition that it is not reproduced, copied or disclosed to a third party, either wholly or in part, without the consent of HellermannTyton.

Drawn	CJR	8/2/18
Approved	KVH	8/2/18
<b>HellermannTyton</b>		
North America Email: corp@htamericas.com Web: www.hellermann.tyton.com		

Article/Type-No	STRAIGHTCHNL
Title	STRAIGHT CHANNEL WITH HOLE AND SLOT
Drawing-No	PRODUCTION : Phase <b>14-1056-002-CSU</b>

Scale	1:1
Project Number	14-1056
Format	AH
Sheet	1/1